

Kolban's  
Book on  
ESP32

**SEPTEMBER 2018**

Neil Kolban

## Table of Contents

Introduction.....	58
Important Documentation Notes – ESP8266 and ESP32.....	59
Overview.....	59
The ESP32.....	60
The ESP32 specification.....	61
ESP32 variants.....	62
Modules.....	63
ESP-WROOM-32.....	63
ESP32-DevKitC.....	64
ESP-WROVER-KIT.....	66
The SparkFun ESP32 thing.....	71
Connecting to the ESP32.....	72
Assembling circuits.....	74
USB to UART converters.....	74
Breadboards.....	76
Power.....	77
Multi-meter / Logic probe / Logic Analyzer.....	78
Sundry components.....	78
Physical construction.....	78
Configuration for flashing the device.....	79
Programming for ESP32.....	80
Espressif IoT Development framework.....	80
Application entry point.....	83
How ESP-IDF works.....	84
Error handling.....	87
The build environment menu configuration.....	87
Adding a custom ESP-IDF component.....	94
Working with memory.....	97
Compiling.....	98
Compilation.....	99
Flashing.....	101
Loading a program.....	103
Programming environments.....	105
Compilation tools.....	105
xtensa-esp32-elf-ar.....	106
esptool.....	107
xtensa-esp32-elf-gcc.....	109
gen_appbin.py.....	110
make.....	111
xtensa-esp32-elf-strip.....	111

xtensa-esp32-elf-nm.....	112
xtensa-esp32-elf-objcopy.....	112
xtensa-esp32-elf-objdump.....	112
xxd.....	112
Linking.....	113
Sizes of images.....	116
Debugging.....	117
ESP-IDF logging.....	117
Exception handling.....	120
Address to source line.....	121
Core dump processing.....	122
Using a debugger (GDB).....	127
OpenOCD and JTAG.....	128
Using the ESP-WROVER-KIT for JTAG.....	131
Port numbers for openocd.....	131
Dumping IP Addresses.....	131
Debugging and testing TCP and UDP connections.....	132
Android – Socket Protocol.....	132
Android – UDP Sender/Receiver.....	132
Android – tPacketCapture.....	132
Windows – Hercules.....	132
SocketTest.....	132
Linux – netcat (nc).....	133
Curl.....	133
Eclipse – TCP/MON.....	134
httpbin.org.....	136
RequestBin.....	136
tcpdump.....	137
ESP-IDF component debugging.....	137
LWIP.....	137
Run a Blinky.....	137
WiFi subsystem.....	138
WiFi Theory.....	138
Initializing the WiFi environment.....	140
Setting the operation mode.....	140
Scanning for access points.....	141
Handling WiFi events.....	144
Station configuration.....	150
Starting up the WiFi environment.....	151
Connecting to an access point.....	152
Being an access point.....	154
Working with connected stations.....	158

WiFi at boot time.....	159
The DHCP client.....	159
The DHCP server.....	160
Current IP Address, netmask and gateway.....	161
WiFi Protected Setup – WPS.....	161
Designs for bootstrapping WiFi.....	161
Tools for WiFi on Linux.....	162
iwlist.....	162
iw.....	163
Working with TCP/IP.....	163
The Lightweight IP Stack – lwip.....	164
TCP.....	165
TCP/IP Sockets.....	166
Handling errors.....	170
Configuration settings.....	173
Using select().....	174
Differences from "standard" sockets.....	175
UDP/IP Sockets.....	175
TLS, SSL and security.....	177
Keys files.....	179
PEM files.....	179
mbedTLS client app structure.....	179
mbedTLS client example.....	182
mbedTLS server app structure.....	184
mbedTLS Debugging.....	185
OpenSSL.....	186
RSA encryption/decryption.....	187
Generate DER data containing a private key.....	188
Name Service.....	188
Multicast Domain Name Systems.....	189
mDNS API programming.....	190
Installing Bonjour.....	191
Avahi.....	193
Working with SNTP.....	195
Java Sockets.....	196
Network performance tests.....	199
Bluetooth.....	200
Bluetooth specification.....	200
Bluetooth UUIDs.....	203
Bluetooth GAP.....	203
Low level packet.....	204
GAP Advertizing data.....	205
Advertisability – limited and general.....	208
Directed advertising.....	208

Non-connectable advertising.....	208
Filtering devices.....	209
Performing a scan.....	209
Performing advertising.....	212
Bluetooth GATT.....	213
GATT Characteristic.....	215
Being a GATT client.....	216
Being a GATT Server.....	218
Notifications and indications.....	218
GATT XML descriptions.....	219
Service Discovery Protocol.....	219
ESP32 and Bluetooth.....	220
GATT Server – Read request.....	221
Debugging ESP32 Bluetooth.....	222
Bluetooth C Programming in Linux.....	222
hci_get_route.....	222
hci_open_dev.....	222
hci_inquiry.....	223
hci_read_remote_name.....	224
str2ba.....	224
ba2str.....	224
Bluetooth programming in Node.js.....	225
Using Noble.....	225
Using Bleno.....	230
Bluetooth Audio.....	231
Bluetooth RFCOMM.....	232
Bluetooth tools.....	234
l2ping.....	234
rfcomm.....	234
bluetoothctl.....	235
hciconfig.....	236
hcidump.....	237
hcidump.....	237
gatttool.....	238
Bluetooth examples.....	239
The iTag peripheral.....	239
Smart Watch / The TW64 Band.....	241
Web Bluetooth.....	243
The Physical Web.....	250
BLE beacons.....	250
Hardware interfacing.....	250
GPIOs.....	251

Pull up and pull down settings.....	253
GPIO Interrupt handling.....	254
Expanding the number of available GPIOs.....	257
PCF8574.....	257
PCF8575.....	261
MCP23017.....	262
Interrupt Service Routines – ISRs.....	267
Working with I2C.....	269
Using the ESP-IDF I2C driver.....	271
Common I2C devices.....	274
Working with SPI – Serial Peripheral Interface.....	274
Using the ESP-IDF SPI driver.....	277
The Arduino Hardware Abstraction Layer SPI.....	281
Common SPI devices.....	283
Working with UART/serial.....	283
Using the VFS component with serial.....	287
I2S Bus.....	287
I2S – Camera.....	287
I2S – LCD.....	288
I2S – DMA.....	288
Interrupts.....	293
RMT – The Remote Peripheral.....	294
Timers and time.....	300
LEDC – Pulse Width Modulation – PWM.....	303
Automated PWM fading.....	307
Analog to digital conversion.....	308
Digital to analog conversion.....	311
Sleep modes.....	312
Security.....	313
Working with flash memory.....	313
Working with RAM memory.....	315
RAM Utilization.....	317
Heap constructions and management.....	318
Heap diagnosis / memory leaks.....	319
Heap corruption.....	320
Using PSRAM.....	323
EFUSE.....	325
EFuse #1.....	326
EFuse #2.....	326
EFuse #3 – 0x6001a00c.....	326
Button press detection.....	326
GPS.....	328
GPS decoding.....	331
Temperature and pressure – BMP180.....	331

Using the Arduino APIs.....	334
Temperature and pressure – BME280.....	334
NeoPixels.....	335
NeoPixel theory.....	335
NeoPixels and the ESP32.....	338
APA102.....	338
LED 7-Segment displays.....	339
MAX7219/MAX7221 – Serial interface, 8-digit, led display drivers.....	340
The U8g2 library.....	344
LCD display – Nokia 5110 – PCD8544.....	345
OLED 128x32, 128x64 – SSD1306.....	347
TFT displays.....	349
Ambient light level sensor – BH1750FVI.....	350
Ambient light and proximity sensor.....	352
Infrared receivers.....	353
RFID MFRC522.....	355
MFRC522 – Low levels.....	357
Initialization.....	360
AntennaOn.....	361
Cameras.....	361
Ivan's sample.....	361
OV7670.....	363
Accelerometer and Gyroscope – MPU-6050 (aka GY-521).....	363
The math of accelerometers.....	369
Visualizing orientation.....	370
Compass – HMC5883L (aka GY-271) (aka CJ-M49).....	370
Tilt compensation of the compass.....	376
Real time clocks.....	377
Servos.....	380
The Mini/Micro SG90.....	382
Audio.....	382
PCM5102 – I2S DAC.....	382
Graphic Equalizer.....	383
External networking.....	386
The nRF24.....	386
Using the Arduino APIs.....	392
Integrating the nRF24 with the ESP32.....	399
Programming using Eclipse.....	402
Installing the Eclipse Serial terminal.....	412
Web development using Eclipse.....	417
Programming using the Arduino IDE.....	418
Mapping from the Arduino to the ESP32.....	419

Implications of Arduino IDE support.....	420
Installing the Arduino IDE with ESP32 support.....	421
Using the Arduino libraries as an ESP-IDF component.....	423
Tips for working in the Arduino environment.....	424
Initialize global classes in setup().....	424
Invoking Espressif SDK API from a sketch.....	424
Reasons to consider using Eclipse over Arduino IDE.....	425
Programming with JavaScript.....	425
Duktape.....	426
Compiling code.....	427
Building for ESP32.....	427
Integrating Duktape in an ESP32 application.....	427
The Duktape stack.....	428
Working with object properties.....	428
Calling C from a JavaScript program.....	428
JerryScript.....	429
Platform specific files.....	429
JerryScript life-cycle.....	430
Accessing the global environment.....	430
The jerry_value_t.....	430
Handling errors.....	431
Interfacing JerryScript with C.....	431
IoT.js.....	432
Programming with Python.....	432
Pycom Micropython.....	432
Programming with Lua.....	432
Lua-RTOS for ESP32.....	432
Integration with Web Apps.....	433
HTTP Protocol.....	433
HTTP Headers.....	433
Accept header.....	433
Authorization header.....	433
Connection header.....	434
Content-Length header.....	434
Content-Type header.....	434
Host header.....	434
User-Agent header.....	434
Web Servers.....	434
Mongoose networking library.....	435
Setting up Mongoose on an ESP32.....	438
Sending a request from Mongoose.....	439
The Mongoose struct mg_connection.....	439
Handling file uploads.....	439
GoAhead Web Server.....	440



JavaScript Webservice.....	441
REST Services.....	441
REST protocol.....	441
ESP32 as a REST client.....	442
Making a REST request using Curl.....	442
Making a REST request using Mongoose.....	447
ESP32 as a REST service provider.....	447
WebSockets.....	447
A WebSocket browser app.....	448
Mongoose WebSocket.....	450
Other Websocket implementations.....	451
Tasker.....	451
AutoRemote.....	451
DuckDNS.....	453
Networking protocols.....	454
MQTT.....	454
Mosquitto MQTT.....	457
Installing on Windows.....	458
Writing ESP32 MQTT clients.....	461
Using Mongoose as an MQTT client.....	461
Using Espruino as an MQTT client.....	463
Writing non ESP32 MQTT clients.....	463
Eclipse paho.....	464
C – Mosquitto client library.....	465
Node.js JavaScript – MQTT.....	467
Browser JavaScript – MQTT.....	468
CoAP – Constrained Application Protocol.....	470
FTP.....	472
TFTP.....	472
Telnet.....	473
DNS Protocol.....	475
Mobile apps.....	478
Blynk.....	478
Cloud environments.....	482
IBM Bluemix.....	482
If This Then That – IFTTT.....	483
ESP Mesh.....	484
Storage programming.....	485
Partition table.....	485
Non Volatile Storage.....	489
Virtual File System.....	490
VFS Implementations.....	491

FATFS File System.....	492
Spiffs File System.....	493
Building SPIFFs for the ESP32.....	495
mkspiffs tool.....	495
The ESP File System – EspFs.....	497
SD, MMC and SDIO interfacing.....	498
SD attachment on Wrover Dev Kit.....	499
ZIP files.....	500
zlib.....	500
miniz.....	500
kuba--/zip.....	500
Charting data.....	501
Kst.....	502
Sample Snippets.....	503
Sample applications.....	503
Sample – Ultrasonic distance measurement.....	503
Sample – WiFi Scanner.....	506
Sample – A changeable mood light.....	507
Using FreeRTOS.....	511
The architecture of a task in FreeRTOS.....	512
Priorities and FreeRTOS tasks.....	515
Stacks and FreeRTOS tasks.....	515
Timers in FreeRTOS.....	518
Blocking and synchronization within FreeRTOS.....	519
Semaphores and Mutices within FreeRTOS.....	520
Queues within FreeRTOS.....	521
Ring buffer within FreeRTOS.....	522
Working with queue sets.....	523
Monitoring capabilities.....	524
Running untested functions.....	525
The Serial AT command processor.....	526
Mongoose OS.....	526
The Mongoose OS file system.....	528
Setting up Mongoose OS WiFi.....	528
Building a Mongoose OS App.....	528
AWS IoT.....	529
The ESP-IDF aws_ iot component.....	531
Google IoT.....	532
Creating a Google Cloud IoT device registry.....	532
MQTT connections to Google IoT.....	532
Using the TI CC2650 SensorTag.....	534
IR Temperature Sensor.....	538
Humidity Service.....	538
Ambient light sensor.....	539

Key Press.....	539
Developing solutions on Linux.....	540
Building a Linux environment.....	540
Hardware architecture.....	542
The CPU and cores.....	542
Intrinsic data types.....	542
Native byte order, endian and network byte order.....	542
Memory mapping and address spaces.....	543
Reading and writing registers.....	545
Pads and multiplexing.....	547
Register based GPIO.....	549
GPIO_OUT_REG.....	552
GPIO_OUT_W1TS_REG.....	552
GPIO_OUT_W1TC_REG.....	552
GPIO_OUT1_REG.....	553
GPIO_OUT1_W1TS_REG.....	553
GPIO_OUT1_W1TC_REG.....	553
GPIO_ENABLE_REG.....	553
GPIO_ENABLE_W1TS_REG.....	553
GPIO_ENABLE_W1TC_REG.....	553
GPIO_ENABLE1_REG.....	553
GPIO_ENABLE1_W1TS_REG.....	554
GPIO_ENABLE1_W1TC_REG.....	554
GPIO_STRAP_REG.....	554
GPIO_IN_REG.....	554
GPIO_IN1_REG.....	554
GPIO_STATUS_REG.....	554
GPIO_STATUS_W1TS_REG.....	555
GPIO_STATUS_W1TC_REG.....	555
GPIO_STATUS1_REG.....	555
GPIO_STATUS1_W1TS_REG.....	555
GPIO_STATUS1_W1TC_REG.....	555
GPIO_PCPU_NMI_INT1_REG.....	555
GPIO_PCPU_NMI_INT1_REG.....	555
GPIO_PINn_REG.....	555
GPIO_FUNCm_IN_SEL_CFG_REG.....	556
GPIO_FUNCn_OUT_SEL_CFG_REG.....	556
IO_MUX_x_REG.....	557
Strapping pins.....	557
Boot mode source.....	558
Debugging on U0TX0 at boot.....	558
Timing of SDIO slave.....	558

Bootloader.....	558
Power modes.....	561
Peripherals.....	561
Remote Control Peripheral – RMT.....	561
SPI.....	565
PID Controller.....	565
UART.....	565
I2S Peripheral.....	566
I2S Input Data.....	566
I2S Clock.....	566
Camera mode.....	567
Registers.....	570
I2S_CONF_REG.....	572
I2S_CONF2_REG.....	572
I2S_CLKM_CONF_REG.....	573
I2S_CONF_CHAN_REG.....	573
I2S_LC_CONF_REG.....	573
I2S_FIFO_CONF_REG.....	574
I2S_IN_LINK_REG.....	574
I2S_RXEOF_NUM_REG.....	574
I2S_CONF_CHAN_REG.....	574
I2S_SAMPLE_RATE_CONF_REG.....	575
I2S_INT_RAW_REG.....	575
I2S_INT_ENA_REG.....	575
I2S_INT_CLR_REG.....	576
RTC.....	577
RTCIO_RTC_GPIO_OUT_DATA.....	577
RTCIO_RTC_GPIO_OUT_DATA_W1TS.....	577
RTCIO_RTC_GPIO_OUT_DATA_W1TC.....	577
RTCIO_RTC_GPIO_ENABLE.....	577
RTCIO_RTC_GPIO_ENABLE_W1TS.....	577
RTCIO_RTC_GPIO_ENABLE_W1TC.....	577
RTCIO_RTC_GPIO_STATUS_INT.....	577
RTCIO_RTC_GPIO_STATUS_INT_W1TS.....	577
RTCIO_RTC_GPIO_STATUS_INT_W1TC.....	577
RTCIO_RTC_GPIO_IN_NEXT.....	577
RTCIO_RTC_GPIO_PINn_WAKEUP_ENABLE.....	578
RTCIO_RTC_GPIO_PINn_INT_TYPE.....	578
RTCIO_RTC_GPIO_PINn_PAD_DRIVER.....	578
RTCIO_DIG_PAD_HOLD_REG.....	578
RTCIO_HALL_XPD_HALL.....	578
RTCIO_HALL_PHASE.....	578
RTCIO_SENSOR_SENSEn_HOLD.....	578
RTCIO_SENSOR_SENSEn_MUX_SEL.....	578

RTCIO_SENSOR_SENSEn_FUN_SEL.....	578
RTCIO_SENSOR_SENSEn_SLP_SEL.....	578
RTCIO_SENSOR_SENSEn_SLP_IE.....	578
RTCIO_SENSOR_SENSEn_FUN_IE.....	578
RTCIO_ADC_ADCn_HOLD.....	578
RTCIO_ADC_ADCn_MUX_SEL.....	578
RTCIO_ADC_ADCn_FUN_SEL.....	578
RTCIO_ADC_ADCn_SLP_SEL.....	578
RTCIO_ADC_ADCn_SLP_IE.....	578
RTCIO_ADC_ADCn_FUN_IE.....	578
RTCIO_PAD_PDAC1_DRV.....	578
RTCIO_PAD_PDAC1_HOLD.....	578
RTCIO_PAD_PDAC1_RDE.....	578
RTCIO_PAD_PDAC1_RUE.....	578
RTCIO_PAD_PDAC1_DAC.....	578
RTCIO_PAD_PDAC1_XPD_DAC.....	578
RTCIO_PAD_PDAC1_MUX_SEL.....	578
RTCIO_PAD_PDAC1_FUN_SEL.....	578
RTCIO_PAD_PDAC1_SLP_SEL.....	578
RTCIO_PAD_PDAC1_SLP_IE.....	578
RTCIO_PAD_PDAC1_SLP_OE.....	579
RTCIO_PAD_PDAC1_FUN_IE.....	579
RTCIO_PAD_PDAC1_DAC_XPD_FORCE.....	579
ULP Processor.....	579
Preparing a ULP co-processor environment.....	580
ULP Instruction set.....	580
NOP – No operation.....	582
ADD – Add to a register.....	582
SUB – Subtract from register.....	582
AND – Logical AND of two operands.....	583
OR – Logical OR of two operands.....	583
LSH – Logical Shift Left.....	583
RSH – Logical Shift Right.....	583
MOVE – Move to register.....	583
ST – Store data to memory.....	584
LD – Load data from memory.....	584
JUMP – Jump to an absolute address.....	584
JUMPR – Jump relative with condition.....	584
JUMPS – Jump relative based on stage count.....	585
STAGE_RST – Reset the stage count register.....	585
STAGE_INC – Increment the stage count register.....	585
STAGE_DEC – Decrement the stage count register.....	585

HALT – End the program.....	585
WAKE – Wakeup the chip.....	585
SLEEP – Set the ULP wakeup timer period.....	585
WAIT – Wait some number of cycles.....	585
TSENS – Do measurement with the temperature sensor.....	586
ADC – Do measurement with ADC.....	586
REG_RD – Read from peripheral register.....	586
REG_WR – Write to peripheral register.....	586
ULP co-processor assembler coding.....	587
Loading and starting a ULP co-processor application.....	588
Waking up the ULP co-processor.....	589
Peripheral registers for ULP co-processor.....	589
SENS_ULP_CP_SLEEP_CYC0_REG.....	589
SENS_ULP_CP_SLEEP_CYC1_REG.....	589
SENS_ULP_CP_SLEEP_CYC2_REG.....	589
SENS_ULP_CP_SLEEP_CYC3_REG.....	589
SENS_ULP_CP_SLEEP_CYC4_REG.....	590
SENS_SAR_START_FORCE_REG.....	590
Electronics.....	591
Transistors as switches.....	591
Logic Level Shifting.....	592
Projects.....	594
JerryScript library for ESP32.....	594
The "require" capability.....	594
API Reference.....	594
Configuration, status and operational retrieval.....	595
Arduino Mapping.....	596
bitRead.....	596
bitWrite.....	596
delay.....	596
digitalWrite.....	596
pinMode.....	597
SPI.begin.....	597
SPI.setBitOrder.....	597
SPI.setClockDivider.....	598
SPI.setDataMode.....	598
SPI.transfer.....	598
Wire.begin.....	598
Wire.beginTransmission.....	599
Wire.endTransmission.....	599
Wire.read.....	599
Wire.requestFrom.....	599
Wire.write.....	599
FreeRTOS API reference.....	599

portENABLE_INTERRUPTS.....	599
portDISABLE_INTERRUPTS.....	600
xPortGetCoreID.....	600
pvPortMalloc.....	600
pvPortFree.....	600
xPortGetFreeHeapSize().....	600
xEventGroupClearBits.....	600
xEventGroupCreate.....	601
xEventGroupCreateStatic.....	601
vEventGroupDelete.....	601
xEventGroupSetBits.....	601
xEventGroupWaitBits.....	602
xQueueAddToSet.....	603
xQueueCreate.....	603
xQueueCreateSet.....	603
xQueueCreateStatic.....	604
vQueueDelete.....	604
xQueueGenericReceive.....	604
uxQueueMessagesWaiting.....	604
xQueueOverwrite.....	605
xQueuePeek.....	605
xQueuePeekFromISR.....	605
xQueueReceive.....	605
xQueueReceiveFromISR.....	606
xQueueRemoveFromSet.....	606
xQueueReset.....	606
xQueueSelectFromSet.....	606
xQueueSelectFromSetFromISR.....	607
xQueueSend.....	607
xQueueSendFromISR.....	607
xQueueSendToBack.....	607
xQueueSendToBackFromISR.....	608
xQueueSendToFront.....	608
xQueueSendToFrontFromISR.....	609
uxQueueSpacesAvailable.....	609
xRingbufferAddToQueueSetRead.....	609
xRingbufferAddToQueueSetWrite.....	609
xRingbufferCreate.....	610
vRingbufferDelete.....	610
xRingbufferGetMaxItemSize.....	610
xRingBufferPrintInfo.....	610
xRingbufferReceive.....	611

xRingbufferReceiveFromISR.....	611
xRingbufferReceiveUpTo.....	611
xRingbufferReceiveUpToFromISR.....	611
xRingbufferRemoveFromQueueSetRead.....	612
xRingbufferRemoveFromQueueSetWrite.....	612
vRingbufferReturnItem.....	612
vRingbufferReturnItemFromISR.....	612
xRingbufferSend.....	612
xRingbufferSendFromISR.....	613
vSemaphoreCreateBinary.....	613
xSemaphoreCreateCounting.....	613
xSemaphoreCreateMutex.....	613
vSemaphoreDelete.....	614
uxSemaphoreGetCount.....	614
xSemaphoreGive.....	614
xSemaphoreGiveFromISR.....	614
xSemaphoreTake.....	614
xTaskCreate.....	615
xTaskCreatePinnedToCore.....	616
vTaskDelay.....	617
vTaskDelayUntil.....	617
vTaskDelete.....	618
taskDISABLE_INTERRUPTS.....	618
taskENABLE_INTERRUPTS.....	619
vTaskGetInfo.....	619
xTaskGetCurrentTaskHandle.....	620
pcTaskGetTaskName.....	620
uxTaskGetNumberOfTasks.....	620
uxTaskGetSnapshotAll.....	621
uxTaskGetStackHighWaterMark.....	621
pxTaskGetStackStart.....	621
eTaskGetState.....	621
uxTaskGetSystemState.....	622
xTaskGetTickCount.....	623
xTaskGetTickCountFromISR.....	623
vTaskList.....	623
uxTaskPriorityGet.....	623
uxTaskPriorityGetFromISR.....	624
vTaskPrioritySet.....	624
vTaskResume.....	624
vTaskResumeFromISR.....	624
xTaskResumeAll.....	625
vTaskResumeFromISR.....	625
vTaskSuspend.....	625



vTaskSuspendAll.....	625
xTimerChangePeriod.....	626
xTimerChangePeriodFromISR.....	626
xTimerCreate.....	626
xTimerCreateStatic.....	627
xTimerDelete.....	627
pcTimerGetName.....	628
xTimerGetExpiryTime.....	628
xTimerGetPeriod.....	628
pvTimerGetTimerDaemonTaskHandle.....	629
pvTimerGetTimerID.....	629
xTimerIsTimerActive.....	629
xTimerPendFunctionCall.....	630
xTimerPendFunctionCallFromISR.....	630
xTimerReset.....	630
xTimerResetFromISR.....	631
vTimerSetTimerID.....	631
xTimerStart.....	631
xTimerStartFromISR.....	632
xTimerStop.....	632
xTimerStopFromISR.....	632
List Processing.....	632
vListInitialise.....	632
vListInitialisemtem.....	632
vListInsert.....	633
vListInsertEnd.....	633
Sockets APIs.....	633
accept.....	633
bind.....	634
close.....	634
closesocket.....	635
connect.....	635
fcntl.....	636
freeaddrinfo.....	636
getaddrinfo.....	636
gethostbyname.....	638
gethostbyname_r.....	638
getpeername.....	639
getsockname.....	639
getsockopt.....	639
htonl.....	640
htons.....	640

inet_ntop.....	640
inet_pton.....	641
ioctlsocket.....	641
listen.....	641
read.....	641
recv.....	642
recvfrom.....	642
select.....	643
send.....	644
sendmsg.....	644
sendto.....	644
setsockopt.....	645
shutdown.....	645
socket.....	646
write.....	647
writev.....	647
Socket data structures.....	647
Sockets – struct sockaddr.....	647
Sockets – struct sockaddr_in.....	647
Working with WiFi.....	647
DNS.....	648
dns_getserver.....	649
dns_setserver.....	649
System Functions.....	649
esp_chip_info.....	649
esp_cpu_in_ocd_debug_mode.....	650
esp_deregister_freertos_idle_hook.....	650
esp_deregister_freertos_tick_hook.....	650
esp_efuse_read_mac.....	650
esp_get_free_heap_size.....	651
esp_get_idf_version.....	651
esp_ipc_call.....	651
esp_ipc_call_blocking.....	652
esp_random.....	652
esp_register_freertos_idle_hook.....	652
esp_register_freertos_idle_hook_for_cpu.....	652
esp_register_freertos_tick_hook.....	652
esp_register_freertos_tick_hook_for_cpu.....	653
esp_restart.....	653
esp_sleep_get_wakeup_cause.....	653
ets_delay_us.....	653
system_rtc_mem_write.....	654
rtc_get_reset_reason.....	654
software_reset.....	655

software_reset_cpu.....	655
system_deep_sleep.....	655
system_get_time.....	655
system_restore.....	656
system_rtc_mem_read.....	656
system_rtc_mem_write.....	656
system_rtc_mem_read.....	656
WiFi.....	657
esp_event_loop_init.....	657
esp_event_loop_set_cb.....	657
esp_wifi_ap_get_sta_list.....	657
esp_wifi_clear_fast_connect.....	658
esp_wifi_connect.....	658
esp_wifi_deinit.....	658
esp_wifi_deinit.....	659
esp_wifi_disconnect.....	659
esp_wifi_free_station_list.....	659
esp_wifi_get_auto_connect.....	660
esp_wifi_get_bandwidth.....	660
esp_wifi_get_channel.....	660
esp_wifi_get_config.....	660
esp_wifi_get_country.....	661
esp_wifi_get_event_mask.....	661
esp_wifi_get_mac.....	661
esp_wifi_get_mode.....	662
esp_wifi_get_promiscuous.....	662
esp_wifi_get_protocol.....	663
esp_wifi_get_ps.....	663
esp_wifi_get_station_list.....	663
esp_wifi_init.....	664
esp_wifi_restore.....	665
esp_wifi_reg_rxc.....	665
esp_wifi_scan_get_ap_records.....	665
esp_wifi_scan_get_ap_num.....	666
esp_wifi_scan_start.....	667
esp_wifi_scan_stop.....	667
esp_wifi_set_auto_connect.....	668
esp_wifi_set_bandwidth.....	668
esp_wifi_set_channel.....	668
esp_wifi_set_config.....	669
esp_wifi_set_country.....	671
esp_wifi_set_event_mask.....	671

esp_wifi_set_mac.....	671
esp_wifi_set_mode.....	672
esp_wifi_set_promiscuous_rx_cb.....	672
esp_wifi_set_promiscuous.....	672
esp_wifi_set_protocol.....	673
esp_wifi_set_ps.....	673
esp_wifi_set_storage.....	674
esp_wifi_set_vendor_ie.....	674
esp_wifi_set_vendor_ie_cb.....	674
esp_wifi_sta_get_ap_info.....	675
esp_wifi_start.....	675
esp_wifi_stop.....	675
WiFi WPS.....	676
wifi_wps_enable.....	676
wifi_wps_disable.....	676
wifi_wps_start.....	676
wifi_set_wps_cb.....	676
mbed TLS.....	677
mbedtls_ctr_drbg_free.....	677
mbedtls_ctr_drbg_init.....	677
mbedtls_ctr_drbg_seed.....	677
mbedtls_debug_set_threshold.....	677
mbedtls_entropy_free.....	678
mbedtls_entropy_init.....	678
mbedtls_net_accept.....	678
mbedtls_net_bind.....	679
mbedtls_net_connect.....	679
mbedtls_net_free.....	680
mbedtls_net_init.....	680
mbedtls_net_recv.....	680
mbedtls_net_recv_timeout.....	681
mbedtls_net_send.....	681
mbedtls_net_set_block.....	681
mbedtls_net_set_nonblock.....	681
mbedtls_pk_decrypt.....	681
mbedtls_pk_encrypt.....	682
mbedtls_pk_free.....	682
mbedtls_pk_get_len.....	682
mbedtls_pk_get_name.....	683
mbedtls_pk_info_from_type.....	683
mbedtls_pk_init.....	683
mbedtls_pk_parse_key.....	683
mbedtls_pk_rsa_context.....	684
mbedtls_pk_setup.....	684

mbedtls_pk_write_key_der.....	685
mbedtls_pk_write_key_pem.....	685
mbedtls_pk_write_pubkey_der.....	685
mbedtls_pk_write_pubkey_pem.....	686
mbedtls_printf.....	686
mbedtls_sha1.....	686
mbedtls_rsa_check_privkey.....	687
mbedtls_rsa_check_pubkey.....	687
mbedtls_rsa_free.....	687
mbedtls_rsa_gen_key.....	687
mbedtls_rsa_init.....	687
mbedtls_rsa_pkcs_encrypt.....	688
mbedtls_ssl_close_notify.....	688
mbedtls_ssl_conf_authmode.....	688
mbedtls_ssl_conf_ca_chain.....	689
mbedtls_ssl_conf_dbg.....	689
mbedtls_ssl_conf_rng.....	689
mbedtls_ssl_config_defaults.....	690
mbedtls_ssl_config_free.....	690
mbedtls_ssl_config_init.....	690
mbedtls_ssl_free.....	691
mbedtls_ssl_get_verify_result.....	691
mbedtls_ssl_handshake.....	691
mbedtls_ssl_init.....	691
mbedtls_ssl_read.....	691
mbedtls_ssl_session_reset.....	692
mbedtls_ssl_set_bio.....	692
mbedtls_ssl_set_hostname.....	692
mbedtls_ssl_setup.....	693
mbedtls_ssl_write.....	693
mbedtls_strerror.....	693
mbedtls_x509_crt_init.....	694
mbedtls_x509_crt_parse.....	694
mbedtls_x509_crt_verify_info.....	694
ESP-TLS.....	694
esp_tls_conn_delete.....	694
esp_tls_conn_http_new.....	695
esp_tls_conn_new.....	695
esp_tls_conn_read.....	695
esp_tls_conn_write.....	695
Bluetooth LE.....	696
esp_bt_uuid_t.....	696

esp_attr_value_t.....	696
esp_gatt_id_t.....	696
esp_gatt_srvc_id_t.....	697
esp_gatt_status_t.....	697
esp_gattc_char_elem_t.....	699
esp_gattc_db_elem_t.....	699
esp_gattc_descr_elem_t.....	699
esp_gattc_service_elem_t.....	700
esp_ble_gap_config_adv_data.....	700
esp_ble_gap_config_adv_data_raw.....	702
esp_ble_gap_config_scan_rsp_data_raw.....	702
esp_ble_gap_config_local_privacy.....	702
esp_ble_gap_disconnect.....	703
esp_ble_gap_get_whitelist_size.....	703
esp_ble_gap_read_rssi.....	703
esp_ble_gap_register_callback.....	703
ESP_GAP_BLE_ADD_WHITELIST_COMPLETE_EVT.....	703
ESP_GAP_BLE_ADV_DATA_SET_COMPLETE_EVT.....	704
ESP_GAP_BLE_ADV_DATA_RAW_SET_COMPLETE_EVT.....	704
ESP_GAP_BLE_ADV_START_COMPLETE_EVT.....	704
ESP_GAP_BLE_ADV_STOP_COMPLETE_EVT.....	704
ESP_GAP_BLE_AUTH_CMPL_EVT.....	704
ESP_GAP_BLE_CLEAR_BOND_DEV_COMPLETE_EVT.....	705
ESP_GAP_BLE_GET_BOND_DEV_COMPLETE_EVT.....	705
ESP_GAP_BLE_KEY_EVT.....	705
ESP_GAP_BLE_LOCAL_ER_EVT.....	705
ESP_GAP_BLE_LOCAL_IR_EVT.....	705
ESP_GAP_BLE_NC_REQ_EVT.....	705
ESP_GAP_BLE_OOB_REQ_EVT.....	705
ESP_GAP_BLE_PASSKEY_NOTIF_EVT.....	705
ESP_GAP_BLE_PASSKEY_REQ_EVT.....	706
ESP_GAP_BLE_READ_RSSI_COMPLETE_EVT.....	706
ESP_GAP_BLE_REMOVE_BOND_DEV_COMPLETE_EVT.....	706
ESP_GAP_BLE_SCAN_PARAM_SET_COMPLETE_EVT.....	706
ESP_GAP_BLE_SCAN_RESULT_EVT.....	706
ESP_GAP_BLE_SCAN_RSP_DATA_RAW_SET_COMPLETE_EVT.....	708
ESP_GAP_BLE_SCAN_RSP_DATA_SET_COMPLETE_EVT.....	708
ESP_GAP_BLE_SCAN_START_COMPLETE_EVT.....	708
ESP_GAP_BLE_SCAN_STOP_COMPLETE_EVT.....	708
ESP_GAP_BLE_SEC_REQ_EVT.....	708
ESP_GAP_BLE_SET_LOCAL_PRIVACY_COMPLETE_EVT.....	709
ESP_GAP_BLE_SET_PKT_LENGTH_COMPLETE_EVT.....	709
ESP_GAP_BLE_SET_STATIC_RAND_ADDR_EVT.....	709
ESP_GAP_BLE_UPDATE_CONN_PARAMS_EVT.....	709

esp_ble_gap_security_rsp.....	710
esp_ble_gap_set_device_name.....	710
esp_ble_set_encryption.....	710
esp_ble_gap_set_pkt_data_len.....	711
esp_ble_gap_set_prefer_conn_params.....	711
esp_ble_gap_set_rand_addr.....	711
esp_ble_gap_set_security_param.....	711
esp_ble_gap_set_scan_params.....	712
esp_ble_gap_start_advertising.....	713
esp_ble_gap_start_scanning.....	715
esp_ble_gap_stop_advertising.....	715
esp_ble_gap_stop_scanning.....	715
esp_ble_gap_update_conn_params.....	716
esp_ble_gap_update_whitelist.....	716
esp_ble_gattc_app_register.....	716
esp_ble_gattc_app_unregister.....	717
esp_ble_gattc_close.....	717
esp_ble_gattc_cache_refresh.....	717
esp_ble_gattc_config_mtu.....	717
esp_ble_gattc_execute_write.....	717
esp_ble_gattc_get_all_char.....	718
esp_ble_gattc_get_all_descr.....	719
esp_ble_gattc_get_attr_count.....	720
esp_ble_gattc_get_char_by_uuid.....	720
esp_ble_gattc_get_characteristic.....	721
esp_ble_gattc_get_db.....	722
esp_ble_gattc_get_descr_by_char_handle.....	722
esp_ble_gattc_get_descr_by_uuid.....	723
esp_ble_gattc_get_descriptor.....	724
esp_ble_gattc_get_include_service.....	724
esp_ble_gattc_get_included_service.....	724
esp_ble_gattc_get_service.....	725
esp_ble_gattc_open.....	725
esp_ble_gattc_prepare_write.....	726
esp_ble_gattc_prepare_write_char_descr.....	727
esp_ble_gattc_read_char.....	727
esp_ble_gattc_read_char_descr.....	727
esp_ble_gattc_read_multiple.....	728
esp_ble_gattc_register_callback.....	728
ESP_GATTCL_ACL_EVT.....	731
ESP_GATTCL_ADV_DATA_EVT.....	731
ESP_GATTCL_ADV_VSC_EVT.....	731

ESP_GATTC_BTH_SCAN_CFG_EVT.....	731
ESP_GATTC_BTH_SCAN_DIS_EVT.....	731
ESP_GATTC_BTH_SCAN_ENB_EVT.....	731
ESP_GATTC_BTH_SCAN_PARAM_EVT.....	731
ESP_GATTC_BTH_SCAN_RD_EVT.....	731
ESP_GATTC_BTH_SCAN_THR_EVT.....	731
ESP_GATTC_CANCEL_OPEN_EVT.....	731
ESP_GATTC_CFG_MTU_EVT.....	731
ESP_GATTC_CLOSE_EVT.....	731
ESP_GATTC_CONGEST_EVT.....	732
ESP_GATTC_CONNECT_EVT.....	732
ESP_GATTC_DISCONNECT_EVT.....	733
ESP_GATTC_ENC_CMPL_CB_EVT.....	733
ESP_GATTC_EXEC_EVT.....	733
ESP_GATTC_GET_CHAR_EVT.....	733
ESP_GATTC_GET_DESCR_EVT.....	734
ESP_GATTC_GET_INCL_SRVC_EVT.....	734
ESP_GATTC_MULT_ADV_DATA_EVT.....	735
ESP_GATTC_MULT_ADV_DIS_EVT.....	735
ESP_GATTC_MULT_ADV_ENB_EVT.....	735
ESP_GATTC_MULT_ADV_UPD_EVT.....	735
ESP_GATTC_NOTIFY_EVT.....	735
ESP_GATTC_OPEN_EVT.....	735
ESP_GATTC_PREP_WRITE_EVT.....	736
ESP_GATTC_READ_CHAR_EVT.....	736
ESP_GATTC_READ_DESC_EVT.....	736
ESP_GATTC_REG_EVT.....	736
ESP_GATTC_REG_FOR_NOTIFY_EVT.....	737
ESP_GATTC_SEARCH_CMPL_EVT.....	737
ESP_GATTC_SEARCH_RES_EVT.....	737
ESP_GATTC_SCAN_FLT_CFG_EVT.....	738
ESP_GATTC_SCAN_FLT_PARAM_EVT.....	738
ESP_GATTC_SCAN_FLT_STATUS_EVT.....	738
ESP_GATTC_SRVC_CHG_EVT.....	738
ESP_GATTC_UNREG_EVT.....	738
ESP_GATTC_UNREG_FOR_NOTIFY_EVT.....	738
ESP_GATTC_WRITE_CHAR_EVT.....	739
esp_ble_gattc_register_for_notify.....	739
esp_ble_gattc_unregister_for_notify.....	739
esp_ble_gattc_search_service.....	740
esp_ble_gattc_write_char.....	740
esp_ble_gattc_write_char_descr.....	741
esp_ble_gatts_add_char.....	742
esp_ble_gatts_add_char_descr.....	744



esp_ble_gatts_add_included_service.....	745
esp_ble_gatts_app_register.....	745
esp_ble_gatts_app_unregister.....	745
esp_ble_gatts_close.....	746
esp_ble_gatts_create_attribute_tab.....	746
esp_ble_gatts_create_service.....	746
esp_ble_gatts_delete_service.....	749
esp_ble_gatts_get_attr_value.....	749
esp_ble_gatts_open.....	749
esp_ble_gatts_register_callback.....	750
ESP_GATTS_ADD_CHAR_DESCR_EVT.....	750
ESP_GATTS_ADD_CHAR_EVT.....	751
ESP_GATTS_ADD_INCL_SRVC_EVT.....	751
ESP_GATTS_CANCEL_OPEN_EVT.....	751
ESP_GATTS_CLOSE_EVT.....	752
ESP_GATTS_CONF_EVT.....	752
ESP_GATTS_CONGEST_EVT.....	752
ESP_GATTS_CONNECT_EVT.....	752
ESP_GATTS_CREAT_ATTR_TAB_EVT.....	753
ESP_GATTS_CREATE_EVT.....	753
ESP_GATTS_DELETE_EVT.....	753
ESP_GATTS_DISCONNECT_EVT.....	754
ESP_GATTS_EXEC_WRITE_EVT.....	754
ESP_GATTS_LISTEN_EVT.....	754
ESP_GATTS_MTU_EVT.....	754
ESP_GATTS_OPEN_EVT.....	755
ESP_GATTS_READ_EVT.....	755
ESP_GATTS_REG_EVT.....	755
ESP_GATTS_RESPONSE_EVT.....	756
ESP_GATTS_SET_ATTR_VAL_EVT.....	756
ESP_GATTS_START_EVT.....	756
ESP_GATTS_STOP_EVT.....	756
ESP_GATTS_UNREG_EVT.....	756
ESP_GATTS_WRITE_EVT.....	756
esp_ble_gatts_send_indicate.....	758
esp_ble_gatts_send_response.....	759
esp_ble_gatts_set_attr_value.....	760
esp_ble_gatts_start_service.....	760
esp_ble_gatts_stop_service.....	760
esp_ble_resolve_adv_data.....	761
esp_ble_tx_power_get.....	762
esp_ble_tx_power_set.....	763

esp_bluedroid_deinit.....	764
esp_bluedroid_disable.....	764
esp_bluedroid_enable.....	764
esp_bluedroid_init.....	764
esp_bt_controller_deinit.....	764
esp_bt_controller_disable.....	765
esp_bt_controller_enable.....	765
esp_bt_controller_get_status.....	765
esp_bt_controller_init.....	765
esp_bt_controller_mem_release.....	766
esp_bt_dev_get_address.....	766
esp_bt_dev_set_device_name.....	766
esp_vhci_host_check_send_available.....	766
esp_vhci_host_register_callback.....	767
esp_vhci_host_send_packet.....	767
ESP MQTT.....	767
esp_mqtt_client_destroy.....	769
esp_mqtt_client_init.....	769
esp_mqtt_client_publish.....	769
esp_mqtt_client_set_uri.....	770
esp_mqtt_client_start.....	770
esp_mqtt_client_stop.....	770
esp_mqtt_client_subscribe.....	770
esp_mqtt_client_unsubscribe.....	770
Mesh.....	771
esp_mesh_allow_root_conflicts.....	771
esp_mesh_available_txupQ_num.....	771
esp_mesh_deinit.....	771
esp_mesh_delete_group_id.....	771
esp_mesh_get_ap_assoc_expire.....	772
esp_mesh_get_ap_authmode.....	772
esp_mesh_get_ap_connections.....	772
esp_mesh_get_capacity_num.....	772
esp_mesh_get_config.....	772
esp_mesh_get_group_list.....	772
esp_mesh_get_group_num.....	773
esp_mesh_get_id.....	773
esp_mesh_get_ie_crypto_key.....	773
esp_mesh_get_layer.....	773
esp_mesh_get_max_layer.....	773
esp_mesh_get_parent_bssid.....	774
esp_mesh_get_root_healing_delay.....	774
esp_mesh_get_router.....	774
esp_mesh_get_routing_table.....	774

esp_mesh_get_routing_table_size.....	774
esp_mesh_get_rx_pending.....	774
esp_mesh_get_self_organized.....	775
esp_mesh_get_total_node_num.....	775
esp_mesh_get_tx_pending.....	775
esp_mesh_get_type.....	775
esp_mesh_get_vote_percentage.....	775
esp_mesh_get_xon_qsize.....	775
esp_mesh_init.....	776
esp_mesh_is_my_group.....	776
esp_mesh_is_root.....	776
esp_mesh_post_toDS_state.....	776
esp_mesh_rcv.....	776
esp_mesh_rcv_toDS.....	777
esp_mesh_send.....	778
esp_mesh_set_ap_assoc_expire.....	778
esp_mesh_set_ap_authmode.....	779
esp_mesh_set_ap_connections.....	779
esp_mesh_set_ap_password.....	779
esp_mesh_set_capacity_num.....	779
esp_mesh_set_config.....	779
esp_mesh_set_event_cb.....	779
esp_mesh_set_group_id.....	780
esp_mesh_set_id.....	780
esp_mesh_set_ie_crypto_funcs.....	780
esp_mesh_set_ie_crypto_key.....	780
esp_mesh_set_max_layer.....	780
esp_mesh_set_root_healing_delay.....	781
esp_mesh_set_router.....	781
esp_mesh_set_self_organized.....	781
esp_mesh_set_type.....	781
esp_mesh_set_vote_percentage.....	781
esp_mesh_set_xon_qsize.....	781
esp_mesh_start.....	782
esp_mesh_stop.....	782
esp_mesh_waive_root.....	782
Upgrade APIs.....	782
system_upgrade_flag_check.....	782
system_upgrade_flag_set.....	783
system_upgrade_reboot.....	783
system_upgrade_start.....	783
system_upgrade_userbin_check.....	783

Smart config APIs.....	783
smartconfig_start.....	783
smartconfig_stop.....	784
SNTP API.....	784
sntp_enabled.....	784
sntp_getoperatingmode.....	784
sntp_getserver.....	784
sntp_getservername.....	784
sntp_init.....	785
sntp_servermode_dhcp.....	785
sntp_setoperatingmode.....	785
sntp_setserver.....	786
sntp_setservername.....	786
sntp_stop.....	787
Generic TCP/UDP APIs.....	787
ipaddr_addr.....	787
IP4_ADDR.....	787
IP2STR.....	788
MAC2STR.....	788
TCP Adapter APIs.....	788
tcpip_adapter_ap_input.....	788
tcpip_adapter_ap_start.....	789
tcpip_adapter_create_ip6_linklocal.....	789
tcpip_adapter_dhcpc_get_status.....	789
tcpip_adapter_dhcpc_option.....	789
tcpip_adapter_dhcpc_start.....	790
tcpip_adapter_dhcpc_stop.....	790
tcpip_adapter_dhcps_get_status.....	791
tcpip_adapter_dhcps_option.....	791
tcpip_adapter_dhcps_start.....	792
tcpip_adapter_dhcps_stop.....	792
tcpip_adapter_down.....	793
tcpip_adapter_eth_input.....	793
tcpip_adapter_eth_start.....	793
tcpip_adapter_free_sta_list.....	793
tcpip_adapter_get_esp_if.....	793
tcpip_adapter_get_dns_info.....	794
tcpip_adapter_get_hostname.....	794
tcpip_adapter_get_ip_info.....	794
tcpip_adapter_get_ip6_linklocal.....	795
tcpip_adapter_get_netif.....	795
tcpip_adapter_get_old_ip_info.....	795
tcpip_adapter_get_sta_list.....	795
tcpip_adapter_get_wifi_if.....	796

tcpip_adapter_init.....	796
tcpip_adapter_set_dns_info.....	796
tcpip_adapter_set_hostname.....	796
tcpip_adapter_set_ip_info.....	797
tcpip_adapter_set_old_ip_info.....	798
tcpip_adapter_sta_input.....	798
tcpip_adapter_sta_start.....	798
tcpip_adapter_start.....	798
tcpip_adapter_stop.....	799
tcpip_adapter_up.....	799
mdns.....	799
mdns_free.....	799
mdns_init.....	800
mdns_query.....	800
mdns_query_end.....	800
mdns_result_free.....	800
mdns_result_get.....	801
mdns_result_get_count.....	801
mdns_service_add.....	801
mdns_service_instance_set.....	802
mdns_service_port_set.....	802
mdns_service_remove.....	802
mdns_service_remove_all.....	802
mdns_service_txt_set.....	802
mdns_set_hostname.....	803
mdns_set_instance.....	803
OTA.....	803
esp_ota_begin.....	805
esp_ota_end.....	806
esp_ota_get_boot_partition.....	806
esp_ota_get_next_update_partition.....	806
esp_ota_get_running_partition.....	807
esp_ota_set_boot_partition.....	807
esp_ota_write.....	807
esp_https_ota.....	808
GPIO Driver.....	808
gpio_config.....	808
gpio_get_level.....	809
gpio_install_isr_service.....	810
gpio_intr_enable.....	810
gpio_intr_disable.....	811
gpio_isr_handler_add.....	811

gpio_isr_handler_remove.....	812
gpio_isr_register.....	812
gpio_set_direction.....	813
gpio_set_intr_type.....	813
gpio_set_level.....	814
gpio_set_pull_mode.....	814
gpio_uninstall_isr_service.....	815
gpio_wakeup_enable.....	815
gpio_wakeup_disable.....	815
GPIO Low Level.....	816
gpio_init.....	816
gpio_input_get.....	816
gpio_input_get_high.....	816
gpio_intr_ack.....	816
gpio_intr_ack_high.....	817
gpio_intr_handler_register.....	817
gpio_intr_pending.....	817
gpio_intr_pending_high.....	817
gpio_matrx_in.....	818
gpio_matrix_out.....	818
gpio_output_set.....	819
gpio_output_set_high.....	819
gpio_pad_hold.....	819
gpio_pad_pulldown.....	820
gpio_pad_pullup.....	820
gpio_pad_select_gpio.....	820
gpio_pad_set_drv.....	820
gpio_pad_unhold.....	820
gpio_pin_wakeup_disable.....	821
gpio_pin_wakeup_enable.....	821
GPIO RTC.....	821
rtc_gpio_init.....	821
rtc_gpio_deinit.....	821
rtc_gpio_get_level.....	821
rtc_gpio_set_level.....	821
rtc_gpio_set_direction.....	821
rtc_gpio_pullup_en.....	822
rtc_gpio_pulldown_en.....	822
rtc_gpio_pullup_dis.....	822
Interrupts.....	822
esp_intr_alloc.....	827
esp_intr_alloc_intrstatus.....	828
esp_intr_disable.....	828
esp_intr_enable.....	829

esp_intr_free.....	829
esp_intr_get_cpu.....	829
esp_intr_get_intno.....	830
esp_intr_mark_shared.....	830
esp_intr_noniram_disable.....	830
esp_intr_noniram_enable.....	830
esp_intr_reserve.....	830
esp_intr_set_in_iram.....	831
Analog to Digital Conversion.....	831
adc1_config_channel_atten.....	831
adc1_config_width.....	832
adc1_get_voltage.....	832
hall_sensor_read.....	832
Digital to Analog Conversion.....	832
dac_i2s_disable.....	832
dac_i2s_enable.....	833
dac_output_disable.....	833
dac_output_enable.....	833
dac_output_voltage.....	834
dac_pad_get_io_num.....	834
UART driver API.....	835
uart_clear_intr_status.....	835
uart_disable_intr_mask.....	835
uart_driver_delete.....	835
uart_driver_install.....	836
uart_disable_intr_mask.....	837
uart_disable_pattern_det_intr.....	837
uart_disable_rx_intr.....	837
uart_disable_tx_intr.....	838
uart_enable_intr_mask.....	838
uart_enable_pattern_det_intr.....	838
uart_enable_rx_intr.....	839
uart_enable_tx_intr.....	839
uart_flush.....	839
uart_flush_input.....	840
uart_get_baudrate.....	840
uart_get_buffered_data_len.....	840
uart_get_collision_flag.....	840
uart_get_hw_flow_ctrl.....	840
uart_get_parity.....	841
uart_get_stop_bits.....	841
uart_get_word_length.....	842

uart_intr_config.....	842
uart_isr_free.....	843
uart_isr_register.....	844
uart_param_config.....	844
uart_pattern_get_pos.....	845
uart_pattern_pop_pos.....	845
uart_pattern_queue_reset.....	845
uart_read_bytes.....	845
uart_set_baudrate.....	845
uart_set_dtr.....	846
uart_set_hw_flow_ctrl.....	846
uart_set_line_inverse.....	847
uart_set_mode.....	847
uart_set_parity.....	847
uart_set_pin.....	848
uart_set_rts.....	848
uart_set_rx_timeout.....	849
uart_set_stop_bits.....	849
uart_set_sw_flow_ctrl.....	849
uart_set_tx_idle_num.....	849
uart_set_word_length.....	849
uart_tx_chars.....	850
uart_wait_tx_done.....	850
uart_write_bytes.....	851
uart_write_bytes_with_break.....	852
UART low level APIs.....	852
uartAttach.....	852
Uart_Init.....	852
uart_div_modify.....	852
uart_buff_switch.....	852
uart_tx_switch.....	852
uart_baudrate_detect.....	852
uart_rx_one_char.....	852
uart_tx_wait_idle.....	853
uart_tx_flush.....	853
uart_tx_one_char.....	853
uart_tx_one_char2.....	853
I2C APIs.....	853
i2c_cmd_link_create.....	853
i2c_cmd_link_delete.....	854
i2c_driver_delete.....	854
i2c_driver_install.....	854
i2c_get_data_mode.....	855
i2c_get_data_timing.....	855



i2s_get_period.....	856
i2c_get_start_timing.....	856
i2c_get_stop_timing.....	856
i2c_isr_free.....	857
i2c_isr_register.....	857
i2c_master_cmd_begin.....	857
i2c_master_read.....	858
i2c_master_read_byte.....	859
i2c_master_start.....	859
i2c_master_stop.....	860
i2c_master_write.....	860
i2c_master_write_byte.....	860
i2c_param_config.....	861
i2c_reset_rx_fifo.....	861
i2c_reset_tx_fifo.....	862
i2c_set_data_mode.....	862
i2c_set_data_timing.....	862
i2c_set_period.....	863
i2c_set_pin.....	863
i2c_set_start_timing.....	864
i2c_set_stop_timing.....	864
i2c_slave_read_buffer.....	864
i2c_slave_write_buffer.....	865
SPI APIs.....	865
spi_bus_add_device.....	865
spi_bus_free.....	867
spi_bus_initialize.....	867
spi_bus_remove_device.....	868
spi_device_get_trans_result.....	868
spi_device_queue_trans.....	869
spi_device_transmit.....	870
I2S APIs.....	871
i2s_adc_enable.....	871
i2s_adc_disable.....	871
i2s_driver_install.....	872
i2s_driver_uninstall.....	872
i2s_pop_sample.....	872
i2s_push_sample.....	872
i2s_read_bytes.....	872
i2s_set_adc_mode.....	872
i2s_set_clk.....	872
i2s_set_dac_mode.....	872

i2s_set_pin.....	872
i2s_set_sample_rates.....	873
i2s_start.....	873
i2s_stop.....	873
i2s_write_bytes.....	873
i2s_write_expand.....	873
i2s_zero_dma_buffer.....	873
RMT APIs.....	873
rmt_clr_intr_enable_mask.....	873
rmt_config.....	874
rmt_driver_install.....	875
rmt_driver_uninstall.....	875
rmt_fill_tx_items.....	876
rmt_get_clk_div.....	876
rmt_get_mem_block_num.....	876
rmt_get_mem_pd.....	877
rmt_get_memory_owner.....	877
rmt_get_ringbuf_handle.....	877
rmt_get_rx_idle_thresh.....	878
rmt_get_status.....	878
rmt_get_source_clk.....	878
rmt_get_tx_loop_mode.....	879
rmt_isr_deregister.....	879
rmt_isr_register.....	879
rmt_memory_rw_rst.....	880
rmt_rx_start.....	880
rmt_rx_stop.....	880
rmt_set_clk_div.....	881
rmt_set_err_intr_en.....	881
rmt_set_idle_level.....	881
rmt_set_intr_enable_mask.....	882
rmt_set_mem_block_num.....	882
rmt_set_mem_pd.....	882
rmt_set_memory_owner.....	882
rmt_set_pin.....	883
rmt_set_rx_filter.....	883
rmt_set_rx_idle_thresh.....	883
rmt_set_rx_intr_en.....	884
rmt_set_tx_carrier.....	884
rmt_set_tx_intr_en.....	884
rmt_set_tx_loop_mode.....	885
rmt_set_tx_thr_intr_en.....	885
rmt_set_source_clk.....	885
rmt_tx_start.....	886

rmt_tx_stop.....	886
rmt_wait_tx_done.....	886
rmt_write_items.....	886
LEDC/PWM APIs.....	887
ledc_bind_channel_timer.....	887
ledc_channel_config.....	888
ledc_fade_func_install.....	888
ledc_fade_start.....	889
ledc_fade_func_uninstall.....	889
ledc_get_duty.....	889
ledc_get_freq.....	889
ledc_set_duty.....	890
ledc_isr_register.....	890
ledc_set_fade.....	891
ledc_set_fade_with_step.....	891
ledc_set_fade_with_time.....	892
ledc_set_freq.....	892
ledc_stop.....	892
ledc_timer_config.....	893
ledc_timer_pause.....	894
ledc_timer_resume.....	894
ledc_timer_rst.....	894
ledc_timer_set.....	895
ledc_update_duty.....	895
Pulse Counter.....	896
pcnt_counter_clear.....	900
pcnt_counter_pause.....	900
pcnt_counter_resume.....	901
pcnt_event_disable.....	901
pcnt_event_enable.....	901
pcnt_filter_enable.....	902
pcnt_filter_disable.....	902
pcnt_get_counter_value.....	902
pcnt_get_event_value.....	902
pcnt_get_filter_value.....	903
pcnt_intr_enable.....	903
pcnt_intr_disable.....	904
pcnt_isr_handler_add.....	904
pcnt_isr_handler_remove.....	904
pcnt_isr_register.....	904
pcnt_isr_service_install.....	905
pcnt_isr_service_uninstall.....	905

pcnt_set_event_value.....	905
pcnt_set_filter_value.....	906
pcnt_set_mode.....	906
pcnt_set_pin.....	907
pcnt_unit_config.....	907
Logging.....	909
esp_err_to_name.....	909
esp_log_level_set.....	909
esp_log_set_vprintf.....	910
esp_log_write.....	910
Non Volatile Storage.....	911
nvs_close.....	911
nvs_commit.....	911
nvs_erase_all.....	912
nvs_erase_key.....	912
nvs_flash_init.....	912
nvs_flash_init_custom.....	913
nvs_get_blob.....	913
nvs_get_str.....	913
nvs_get_i8.....	914
nvs_get_i16.....	914
nvs_get_i32.....	915
nvs_get_i64.....	915
nvs_get_u8.....	915
nvs_get_u16.....	916
nvs_get_u32.....	916
nvs_get_u64.....	916
nvs_open.....	917
nvs_set_blob.....	917
nvs_set_str.....	918
nvs_set_i8.....	918
nvs_set_i16.....	918
nvs_set_i32.....	919
nvs_set_i64.....	919
nvs_set_u8.....	919
nvs_set_u16.....	920
nvs_set_u32.....	920
nvs_set_u64.....	920
Partition API.....	921
esp_partition_erase_range.....	921
esp_partition_find.....	921
esp_partition_find_first.....	922
esp_partition_get.....	924
esp_partition_iterator_release.....	925

esp_partition_mmap.....	925
esp_partition_next.....	926
esp_partition_read.....	926
esp_partition_write.....	927
Virtual File System.....	927
esp_vfs_dev_uart_register.....	927
esp_vfs_dev_uart_set_rx_line_endings.....	928
esp_vfs_dev_uart_set_tx_line_endings.....	928
esp_vfs_dev_uart_use_nonblocking.....	928
esp_vfs_dev_uart_use_driver.....	928
esp_vfs_spiffs_register.....	929
esp_vfs_spiffs_unregister.....	929
esp_vfs_register.....	929
FatFs file system.....	933
esp_vfs_fat_register.....	934
esp_vfs_fat_sdmmc_mount.....	934
esp_vfs_fat_sdmmc_unmount.....	936
esp_vfs_fat_spiflash_mount.....	936
esp_vfs_fat_spiflash_unmount.....	937
esp_vfs_fat_unregister.....	938
esp_vfs_fat_unregister_path.....	938
f_mount.....	938
ff_diskio_register.....	938
SPI Flash.....	939
spi_flash_erase_range.....	939
spi_flash_erase_sector.....	939
spi_flash_get_chip_size.....	940
spi_flash_get_counters.....	940
spi_flash_init.....	940
spi_flash_mmap.....	940
spi_flash_mmap_dump.....	941
spi_flash_munmap.....	941
spi_flash_read.....	941
spi_flash_reset_counters.....	942
spi_flash_write.....	942
SDMMC.....	942
sdmmc_card_init.....	942
sdmmc_card_print_info.....	943
sdmmc_host_deinit.....	943
sdmmc_host_do_transaction.....	943
sdmmc_host_init.....	943
sdmmc_host_init_slot.....	944

sdmmc_host_set_bus_width.....	944
sdmmc_host_set_card_clk.....	944
sdmmc_io_enable_int.....	944
sdmmc_io_read_blocks.....	944
sdmmc_io_read_byte.....	944
sdmmc_io_read_bytes.....	945
sdmmc_io_wait_int.....	945
sdmmc_io_write_blocks.....	945
sdmmc_io_write_byte.....	945
sdmmc_io_write_bytes.....	945
sdmmc_read_sectors.....	945
sdmmc_write_sectors.....	946
HTTP Client.....	946
esp_http_client_cleanup.....	946
esp_http_client_close.....	946
esp_http_client_delete_header.....	947
esp_http_client_fetch_headers.....	947
esp_http_client_get_content_length.....	947
esp_http_client_get_post_field.....	947
esp_http_client_get_status_code.....	948
esp_http_client_init.....	948
esp_http_client_is_chunked_response.....	950
esp_http_client_open.....	950
esp_http_client_perform.....	950
esp_http_client_read.....	950
esp_http_client_set_header.....	950
esp_http_client_set_method.....	951
esp_http_client_set_post_field.....	951
esp_http_client_set_url.....	951
esp_http_client_write.....	951
HTTP Server.....	952
httpd_query_key_value.....	952
httpd_queue_work.....	952
httpd_register_uri_handler.....	953
httpd_req_get_hdr_value_len.....	953
httpd_req_get_hdr_value_str.....	954
httpd_req_get_url_query_len.....	954
httpd_req_get_url_query_str.....	955
httpd_req_recv.....	955
httpd_req_to_sockfd.....	955
httpd_resp_send.....	956
httpd_resp_send_404.....	956
httpd_resp_send_chunk.....	956
httpd_resp_set_hdr.....	956

httpd_resp_set_status.....	957
httpd_resp_set_type.....	957
httpd_send.....	958
httpd_sess_get_ctx.....	958
httpd_sess_update_timestamp.....	958
httpd_set_recv_override.....	958
httpd_set_send_override.....	958
httpd_start.....	959
httpd_stop.....	959
httpd_trigger_sess_close.....	960
httpd_unregister_uri_handler.....	960
httpd_unregister_uri.....	960
Cryptography.....	961
base64_decode.....	961
base64_encode.....	961
esp_sha.....	962
esp_sha_block.....	962
esp_sha_lock_engine.....	963
esp_sha_lock_memory_block.....	963
esp_sha_read_digest_state.....	963
esp_sha_try_lock_engine.....	963
esp_sha_unlock_engine.....	963
esp_sha_wait_idle.....	963
Hash processing.....	963
crc32_le.....	963
crc32_be.....	963
crc16_le.....	964
crc16_be.....	964
crc8_le.....	964
crc8_be.....	964
Hardware Timers.....	964
timer_disable_intr.....	964
timer_enable_intr.....	965
timer_get_alarm_value.....	965
timer_get_config.....	966
timer_get_counter_time_sec.....	966
timer_get_counter_value.....	967
timer_group_intr_enable.....	967
timer_group_intr_disable.....	968
timer_isr_register.....	968
timer_init.....	968
timer_pause.....	969

timer_set_counter_value.....	969
timer_start.....	970
timer_set_alarm.....	970
timer_set_alarm_value.....	971
timer_set_auto_reload.....	971
timer_set_counter_mode.....	972
timer_set_divider.....	972
Pthreads.....	973
esp_thread_get_cfg.....	973
esp_thread_init.....	973
esp_thread_set_cfg.....	973
pthread_cancel.....	974
pthread_create.....	974
pthread_cond_broadcast.....	975
pthread_cond_destroy.....	975
pthread_cond_init.....	975
pthread_cond_signal.....	975
pthread_cond_timedwait.....	975
pthread_cond_wait.....	975
pthread_condattr_init.....	975
pthread_detach.....	975
pthread_equal.....	976
pthread_getspecific.....	976
pthread_join.....	976
pthread_key_create.....	976
pthread_key_delete.....	977
pthread_once.....	977
pthread_mutex_destroy.....	978
pthread_mutex_init.....	978
pthread_mutexattr_destroy.....	978
pthread_mutexattr_gettype.....	978
pthread_mutexattr_init.....	979
pthread_mutexattr_settype.....	979
pthread_mutex_lock.....	979
pthread_mutex_trylock.....	979
pthread_mutex_unlock.....	980
pthread_self.....	980
pthread_setspecific.....	980
sched_yield.....	981
Watchdog processing.....	981
esp_int_wdt_init.....	983
esp_task_wdt_add.....	983
esp_task_wdt_deinit.....	984
esp_task_wdt_delete.....	984



esp_task_wdt_feed – DEPRECATED.....	985
esp_task_wdt_init.....	985
esp_task_wdt_reset.....	986
esp_task_wdt_status.....	986
Heap management.....	986
heap_trace_record_t.....	986
heap_caps_add_region.....	987
heap_caps_add_region_with_caps.....	987
heap_caps_calloc.....	987
heap_caps_calloc_prefer.....	987
heap_caps_check_integrity.....	987
heap_caps_check_integrity_addr.....	988
heap_caps_check_integrity_all.....	988
heap_caps_dump.....	988
heap_caps_dump_all.....	989
heap_caps_enable_nonos_stack_heaps.....	989
heap_caps_free.....	989
heap_caps_get_free_size.....	989
heap_caps_get_minimum_free_size.....	990
heap_caps_get_largest_free_block.....	990
heap_caps_get_info.....	990
heap_caps_init.....	991
heap_caps_malloc.....	991
heap_caps_malloc_extmem_enable.....	992
heap_caps_malloc_prefer.....	992
heap_caps_print_heap_info.....	992
heap_caps_realloc.....	993
heap_caps_realloc_prefer.....	993
heap_trace_dump.....	993
heap_trace_get.....	993
heap_trace_get_count.....	994
heap_trace_init_standalone.....	994
heap_trace_resume.....	995
heap_trace_start.....	995
heap_trace_stop.....	995
ULP Co-processor.....	996
RTC_SLOW_MEM.....	996
ulp_process_macros_and_load.....	996
ulp_load_binary.....	996
ulp_run.....	997
ulp_set_wakeup_period.....	997
AWS-IoT.....	998

IoT_Error_t.....	998
aws_iot_is_autoreconnect_enabled.....	998
aws_iot_mqtt_attempt_reconnect.....	998
aws_iot_mqtt_autoreconnect_set_status.....	998
aws_iot_mqtt_connect.....	999
aws_iot_mqtt_disconnect.....	999
aws_iot_mqtt_get_client_state.....	1000
aws_iot_mqtt_get_network_disconnected_count.....	1000
aws_iot_mqtt_get_next_packet_id.....	1000
aws_iot_mqtt_init.....	1001
aws_iot_mqtt_is_client_connected.....	1001
aws_iot_mqtt_publish.....	1001
aws_iot_mqtt_reset_network_disconnected_count.....	1002
aws_iot_mqtt_resubscribe.....	1002
aws_iot_mqtt_set_connect_params.....	1002
aws_iot_mqtt_set_disconnect_handler.....	1003
aws_iot_mqtt_subscribe.....	1003
aws_iot_mqtt_unsubscribe.....	1004
aws_iot_mqtt_yield.....	1004
Console.....	1004
esp_console_cmd_register.....	1005
esp_console_deinit.....	1005
esp_console_get_completion.....	1006
esp_console_get_hint.....	1006
esp_console_init.....	1006
esp_console_register_help_command.....	1006
esp_console_run.....	1006
esp_console_split_argv.....	1007
linenoise.....	1007
linenoise.....	1008
linenoiseAddCompletion.....	1008
linenoiseClearScreen.....	1009
linenoiseFree.....	1009
linenoiseHistoryAdd.....	1009
linenoiseHistorySetMaxLen.....	1009
linenoiseHistorySave.....	1009
linenoiseHistoryLoad.....	1010
linenoiseSetCompletionCallback.....	1010
linenoiseSetFreeHintsCallback.....	1010
linenoiseSetHintsCallback.....	1010
linenoiseSetMultiLine.....	1010
linenoisePrintKeyCodes.....	1011
argtable.....	1011
arg_lit0.....	1012

arg_lit1.....	1012
arg_litn.....	1013
arg_key0.....	1013
arg_key1.....	1013
arg_keyn.....	1013
arg_int0.....	1014
arg_int1.....	1014
arg_intn.....	1015
arg_dbl0.....	1015
arg_dbl1.....	1015
arg_dbln.....	1016
arg_str0.....	1016
arg_str1.....	1017
arg_strn.....	1017
arg_rex0.....	1017
arg_rex1.....	1018
arg_rexn.....	1018
arg_file0.....	1019
arg_file1.....	1019
arg_filen.....	1020
arg_date0.....	1020
arg_date1.....	1020
arg_daten.....	1021
arg_end.....	1021
arg_nullcheck.....	1021
arg_parse.....	1022
arg_print_option.....	1022
arg_print_syntax.....	1022
arg_print_syntaxv.....	1022
arg_print_glossary.....	1023
arg_print_glossary_gnu.....	1023
arg_print_errors.....	1023
arg_free.....	1023
arg_freetable.....	1023
arg_print_formatted.....	1024
JSON processing.....	1024
HTTP/2 processing.....	1027
Parsing XML – expat.....	1027
Miniz.....	1027
mz_free.....	1028
mz_adler32.....	1028
mz_crc32.....	1028

mz_version.....	1028
mz_deflateInit.....	1028
mz_deflateInit2.....	1028
mz_deflateReset.....	1029
mz_deflate.....	1029
mz_deflateEnd.....	1029
mz_deflateBound.....	1029
mz_compressBound.....	1029
mz_inflateInit.....	1029
mz_inflateInit2.....	1029
mz_inflateEnd.....	1029
mz_uncompress.....	1029
mz_error.....	1030
mz_zip_reader_init.....	1030
mz_zip_reader_init_mem.....	1030
mz_zip_reader_get_num_files.....	1030
mz_zip_reader_file_stat.....	1030
mz_zip_reader_is_file_a_directory.....	1030
mz_zip_reader_is_file_encrypted.....	1030
mz_zip_reader_get_filename.....	1030
mz_zip_reader_locate_file.....	1030
mz_zip_reader_extract_to_mem_no_alloc.....	1031
mz_zip_reader_extract_file_to_mem_no_alloc.....	1031
mz_zip_reader_extract_to_mem.....	1031
mz_zip_reader_extract_file_to_mem.....	1031
mz_zip_reader_extract_to_heap.....	1031
mz_zip_reader_extract_file_to_heap.....	1031
mz_zip_reader_extract_to_callback.....	1031
mz_zip_reader_extract_file_to_callback.....	1031
mz_zip_reader_extract_to_file.....	1032
mz_zip_reader_extract_file_to_file.....	1032
mz_zip_reader_end.....	1032
mz_zip_writer_init.....	1032
mz_zip_writer_init_heap.....	1032
mz_zip_writer_init_file.....	1032
mz_zip_writer_init_from_reader.....	1032
mz_zip_writer_add_mem.....	1032
mz_zip_writer_add_mem_ex.....	1032
mz_zip_writer_add_file.....	1033
mz_zip_writer_add_from_zip_reader.....	1033
mz_zip_writer_finalize_archive.....	1033
mz_zip_writer_finalize_heap_archive.....	1033
mz_zip_writer_end.....	1033
mz_zip_add_mem_to_archive_file_in_place.....	1033

mz_zip_extract_archive_file_to_heap.....	1033
tinfl_decompress.....	1033
tinfl_decompress_mem_to_heap.....	1035
tinfl_decompress_mem_to_mem.....	1035
tinfl_decompress_mem_to_callback.....	1035
tinfl_init.....	1036
tinfl_get_adler32.....	1036
tdefl_compress_mem_to_heap.....	1036
tdefl_compress_mem_to_mem.....	1036
tdefl_write_image_to_png_file_in_memory_ex.....	1036
tdefl_write_image_to_png_file_in_memory.....	1036
tdefl_compress_mem_to_output.....	1037
tdefl_init.....	1037
tdefl_compress.....	1038
tdefl_compress_buffer.....	1038
tdefl_get_prev_return_status.....	1038
tdefl_get_adler32.....	1038
tdefl_create_comp_flags_from_zip_params.....	1038
Arduino – ESP32 HAL for UART.....	1038
uartAvailable.....	1038
uartBegin.....	1039
uartEnd.....	1039
uartFlush.....	1040
uartGetBaudRate.....	1040
uartGetDebug.....	1040
uartPeek.....	1040
uartRead.....	1041
uartSetBaudRate.....	1041
uartSetDebug.....	1041
uartWrite.....	1041
uartWriteBuf.....	1042
Arduino – ESP32 HAL for I2C.....	1042
i2cAttachSCL.....	1042
i2cAttachSDA.....	1042
i2cDetachSCL.....	1042
i2cDetachSDA.....	1042
i2cGetFrequency.....	1043
i2cInit.....	1043
i2cRead.....	1043
i2cSetFrequency.....	1043
i2cWrite.....	1044
Arduino – ESP32 HAL for SPI.....	1044

spiAttachMISO.....	1044
spiAttachMOSI.....	1044
spiAttachSCK.....	1044
spiAttachSS.....	1044
spiClockDivToFrequency.....	1045
spiDetachMISO.....	1045
spiDetachMOSI.....	1045
spiDetachSCK.....	1045
spiDetachSS.....	1045
spiDisableSSPins.....	1045
spiEnableSSPins.....	1045
spiFrequencyToClockDiv.....	1045
spiGetBitOrder.....	1046
spiGetClockDiv.....	1046
spiGetDataMode.....	1046
spiRead.....	1046
spiReadByte.....	1047
spiReadLong.....	1047
spiReadWord.....	1047
spiSetBitOrder.....	1047
spiSetClockDiv.....	1047
spiSetDataMode.....	1047
spiSSClear.....	1048
spiSSDisable.....	1048
spiSSEnable.....	1048
spiSSSet.....	1048
spiStartBus.....	1048
spiStopBus.....	1049
spiTransferBits.....	1049
spiTransferBytes.....	1049
spiWaitReady.....	1050
spiWrite.....	1050
spiWriteByte.....	1050
spiWriteLong.....	1050
spiWriteWord.....	1050
Newlib.....	1050
abort.....	1051
abs.....	1051
asctime.....	1051
atoi.....	1052
atol.....	1052
bzero.....	1052
calloc.....	1053
check_pos.....	1053

close.....	1053
closedir.....	1053
creat.....	1053
ctime.....	1053
div.....	1054
environ.....	1054
fclose.....	1054
fflush.....	1055
fmemopen.....	1055
fprintf.....	1055
fread.....	1056
free.....	1056
fscanf.....	1056
fseek.....	1056
fstat.....	1056
fwrite.....	1057
gettimeofday.....	1057
gmtime.....	1058
isalnum.....	1058
isalpha.....	1058
isascii.....	1059
isblank.....	1059
isdigit.....	1059
islower.....	1059
isprint.....	1060
ispunct.....	1060
isspace.....	1060
isupper.....	1060
itoa.....	1061
labs.....	1061
ldiv.....	1061
localtime.....	1061
lseek.....	1061
malloc.....	1062
memchr.....	1062
memcmp.....	1062
memcpy.....	1063
memmove.....	1063
memrchr.....	1063
memset.....	1063
mkdir.....	1064
mktime.....	1064

open.....	1064
open_memstream.....	1065
opendir.....	1066
printf.....	1066
qsort.....	1066
rand.....	1066
read.....	1067
readdir.....	1067
realloc.....	1068
rewinddir.....	1068
scanf.....	1068
seekdir.....	1068
setenv.....	1068
setlocale.....	1068
settimeofday.....	1069
sprintf.....	1069
srand.....	1069
sscanf.....	1069
stat.....	1070
strcasecmp.....	1070
strcasestr.....	1070
strcat.....	1070
strchr.....	1070
strcmp.....	1071
strcoll.....	1071
strcpy.....	1071
strcspn.....	1071
strdup.....	1071
strerror.....	1072
strftime.....	1072
strlcat.....	1072
strlcpy.....	1072
strlen.....	1072
strncasecmp.....	1073
strncat.....	1073
strncmp.....	1073
strncpy.....	1073
strndup.....	1073
strnlen.....	1073
strrchr.....	1074
strsep.....	1074
strspn.....	1074
strstr.....	1074
strtod.....	1074



strtof.....	1074
strtol.....	1075
strtoul.....	1075
strupr.....	1075
telldir.....	1075
time.....	1075
times.....	1075
toascii.....	1076
tolower.....	1076
toupper.....	1076
tzset.....	1076
ungetc.....	1077
unlink.....	1077
utoa.....	1077
vprintf.....	1077
vscanf.....	1077
write.....	1078
SPIFFs API.....	1078
esp_spiffs_format.....	1078
esp_spiffs_info.....	1078
esp_spiffs_mounted.....	1079
SPIFFS_check.....	1079
SPIFFS_clearerr.....	1079
SPIFFS_close.....	1079
SPIFFS_closedir.....	1080
SPIFFS_creat.....	1080
SPIFFS_eof.....	1080
SPIFFS_errno.....	1080
SPIFFS_fflush.....	1082
SPIFFS_format.....	1082
SPIFFS_fremove.....	1082
SPIFFS_fstat.....	1083
SPIFFS_gc.....	1083
SPIFFS_gc_quick.....	1083
SPIFFS_info.....	1083
SPIFFS_lseek.....	1084
SPIFFS_mount.....	1084
SPIFFS_mounted.....	1085
SPIFFS_open.....	1085
SPIFFS_open_by_dirent.....	1086
SPIFFS_open_by_page.....	1086
SPIFFS_opendir.....	1087

SPIFFS_read.....	1087
SPIFFS_readdir.....	1087
SPIFFS_remove.....	1088
SPIFFS_rename.....	1088
SPIFFS_stat.....	1088
SPIFFS_tell.....	1089
SPIFFS_unmount.....	1089
SPIFFS_write.....	1089
Eclipse Paho – MQTT Embedded C.....	1090
MQTTClientInit.....	1090
MQTTConnect.....	1090
MQTTDisconnect.....	1091
MQTTPublish.....	1092
MQTTRun.....	1092
MQTTSubscribe.....	1092
MQTTUnsubscribe.....	1093
MQTTYield.....	1093
NetworkConnect.....	1093
Arduino ESP32 Libraries.....	1093
Arduino WiFi library.....	1093
WiFi.begin.....	1094
WiFi.beingSmartConfig.....	1095
WiFi.beginWPSConfig.....	1095
WiFi.BSSID.....	1095
WiFi.BSSIDstr.....	1095
WiFi.channel.....	1095
WiFi.config.....	1096
WiFi.disconnect.....	1096
WiFi.dnsIP.....	1096
WiFi.enableAP.....	1096
WiFi.enableSTA.....	1096
WiFi.encryptionType.....	1097
WiFi.gatewayIP.....	1097
WiFi.getAutoConnect.....	1097
WiFi.getMode.....	1097
WiFi.getNetworkInfo.....	1097
WiFi.hostByName.....	1098
WiFi.hostname.....	1098
WiFi.isConnected.....	1098
WiFi.isHidden.....	1098
WiFi.localIP.....	1099
WiFi.macAddress.....	1099
WiFi.mode.....	1099
Wifi.persistent.....	1100

WiFi.printDiag.....	1100
WiFi.psk.....	1100
WiFi.RSSI.....	1100
WiFi.scanComplete.....	1101
WiFi.scanDelete.....	1101
WiFi.scanNetworks.....	1101
WiFi.setAutoConnect.....	1102
WiFi.setAutoReconnect.....	1102
WiFi.smartConfigDone.....	1102
WiFi.softAP.....	1102
WiFi.softAPConfig.....	1103
WiFi.softAPdisconnect.....	1103
WiFi.softAPmacAddress.....	1103
WiFi.softAPIP.....	1103
WiFi.SSID.....	1103
WiFi.status.....	1104
WiFi.stopSmartConfig.....	1104
WiFi.subnetMask.....	1104
WiFi.waitForConnectResult.....	1104
Arduino WiFiClient.....	1105
WiFiClient.....	1105
WiFiClient.available.....	1105
WiFiClient.connect.....	1105
WiFiClient.connected.....	1106
WiFiClient.flush.....	1106
WiFiClient.getNoDelay.....	1106
WiFiClient.peek.....	1106
WiFiClient.read.....	1106
WiFiClient.remoteIP.....	1106
WiFiClient.remotePort.....	1106
WiFiClient.setLocalPortStart.....	1107
WiFiClient.setNoDelay.....	1107
WiFiClient.setOption.....	1107
WiFiClient.status.....	1107
WiFiClient.stop.....	1107
WiFiClient.stopAll.....	1107
WiFiClient.write.....	1107
Arduino WiFiServer.....	1108
WiFiServer.....	1108
WiFiServer.available.....	1108
WiFiServer.begin.....	1108
WiFiServer.getNoDelay.....	1108

WiFiServer.hasClient.....	1108
WiFiServer.setNoDelay.....	1108
WiFiServer.status.....	1108
WiFiServer.write.....	1108
Arduino IPAddress.....	1109
Arduino SPI.....	1109
SPI.begin.....	1109
SPI.beginTransaction.....	1109
SPI.end.....	1109
SPI.endTransaction.....	1110
SPI.setBitOrder.....	1110
SPI.setClockDivider.....	1110
SPI.setDataMode.....	1110
SPI.setFrequency.....	1110
SPI.setHwC.....	1110
SPI.transfer.....	1110
SPI.transfer16.....	1110
SPI.transfer32.....	1110
SPI.transferBytes.....	1111
SPI.transferBits.....	1111
SPI.write.....	1111
SPI.write16.....	1111
SPI.write32.....	1111
SPI.writeBytes.....	1111
SPI.writePattern.....	1111
Arduino I2C – Wire.....	1111
Wire.available.....	1112
Wire.begin.....	1112
Wire.beginTransaction.....	1113
Wire.endTransmission.....	1113
Wire.flush.....	1113
Wire.onReceive.....	1113
Wire.onReceiveService.....	1114
Wire.onRequest.....	1114
Wire.onRequestService.....	1114
Wire.peek.....	1114
Wire.pins.....	1114
Wire.read.....	1115
Wire.requestFrom.....	1115
Wire.setClock.....	1115
Wire.write.....	1116
Arduino Ticker library.....	1116
Ticker.....	1116
attach.....	1116

attach_ms.....	1117
detach.....	1117
once.....	1117
once_ms.....	1117
Arduino EEPROM library.....	1118
EEPROM.begin.....	1118
EEPROM.commit.....	1118
EEPROM.end.....	1118
EEPROM.get.....	1118
EEPROM.getDataPtr.....	1118
EEPROM.put.....	1118
EEPROM.read.....	1119
EEPROM.write.....	1119
Arduino SPIFFS.....	1119
SPIFFS.begin.....	1119
SPIFFS.open.....	1119
SPIFFS.openDir.....	1120
SPIFFS.remove.....	1120
SPIFFS.rename.....	1120
File.available.....	1120
File.close.....	1120
File.flush.....	1120
File.name.....	1120
File.peek.....	1121
File.position.....	1121
File.read.....	1121
File.seek.....	1121
File.size.....	1121
File.write.....	1121
Dir.fileName.....	1122
Dir.next.....	1122
Dir.open.....	1122
Dir.openDir.....	1122
Dir.remove.....	1122
Dir.rename.....	1122
Arduino ESP library.....	1122
ESP.eraseConfig.....	1122
ESP.getChipId.....	1122
ESP.getCpuFreqMHz.....	1122
ESP.getCycleCount.....	1123
ESP.getFlashChipMode.....	1123
ESP.getFlashChipSize.....	1123

ESP.getFlashChipSpeed.....	1123
ESP.getFreeHeap.....	1123
ESP.getOption.....	1123
ESP.getSdkVersion.....	1123
ESP.flashEraseSector.....	1123
ESP.flashRead.....	1123
ESP.flashWrite.....	1123
ESP.magicFlashChipSize.....	1124
ESP.magicFlashChipSpeed.....	1124
ESP.restart.....	1124
Arduino String library.....	1124
Constructor.....	1124
String.c_str.....	1124
String.reserve.....	1124
String.length.....	1124
String.concat.....	1125
String.equalsIgnoreCase.....	1125
String.startsWith.....	1125
String.endsWith.....	1125
String.charAt.....	1125
String.setCharAt.....	1125
String.getBytes.....	1125
String.toCharArray.....	1125
String.indexOf.....	1125
String.lastIndexOf.....	1126
String.substring.....	1126
String.replace.....	1126
String.remove.....	1126
String.toLowerCase.....	1126
String.toUpperCase.....	1126
String.trim.....	1126
String.toInt.....	1126
String.toFloat.....	1126
Reference materials.....	1126
Internal structure of compiled code.....	1127
Using size.....	1129
Using objdump.....	1129
Using objcopy.....	1129
Using nm.....	1129
Linking.....	1130
Linker scripts.....	1132
Weak linkage.....	1134
Memory Map.....	1135
Dynamic linking.....	1141

Section garbage collection.....	1150
C++ class initialization.....	1151
The Bootloader.....	1151
Runtime memory.....	1154
Cache memory processing.....	1155
MMU processing.....	1156
C++ Programming.....	1158
Eclipse configuration.....	1158
Simple class definition.....	1159
Mixing C and C++.....	1160
Including stdc++ in your app.....	1161
C++ Specialized Data types.....	1161
String.....	1161
List.....	1162
Map.....	1163
Queue.....	1163
Stack.....	1163
Vector.....	1164
Lambda functions.....	1164
Designated initializers not available in C++.....	1164
Ignoring warnings.....	1165
File I/O in C++.....	1165
The Factory pattern.....	1166
Logging pre-defined symbols.....	1166
The ESP-IDF C++ class libraries.....	1167
GPIO interactions.....	1167
WiFi.....	1167
Task management.....	1169
Socket programming.....	1169
Socket Server.....	1170
HttpServer.....	1170
WebSocket.....	1172
WebSocket File Transfer.....	1174
Performance.....	1175
FTP Server.....	1175
C++ I2C Interaction.....	1176
SPI Interaction.....	1177
Pulse Width Modulation – PWM.....	1178
Bluetooth BLE.....	1178
A BLE Server.....	1180
A BLE Client.....	1186
Non Volatile Storage.....	1191

FAT FS.....	1191
Working with JSON.....	1191
POSIX file system APIs.....	1192
Documenting your code – Doxygen.....	1193
Creating a build environment on the Raspberry Pi 3.....	1194
Using Microsoft Visual Studio Code for development.....	1196
Debugging with Visual Studio Code.....	1197
Windows Subsystem for Linux – WSL.....	1200
Makefiles.....	1201
The component.mk settings.....	1204
CMake.....	1205
The ESPTOOL protocol.....	1206
0x02 – FLASH_BEGIN.....	1209
0x03 – FLASH_DATA.....	1210
0x04 – FLASH_END.....	1210
0x05 – MEM_BEGIN.....	1210
0x06 – MEM_END command.....	1211
0x07 – MEM_DATA command.....	1211
0x08 – SYNC command.....	1212
0x09 – WRITE_REG.....	1212
0x0A – READ_REG.....	1212
0x0B – SPI_SET_PARAMS.....	1212
0x0D – SPI_ATTACH.....	1213
0x0F – CHANGE_BAUDRATE.....	1213
0x10 - FLASH_DEFL_BEGIN.....	1213
0x11 - FLASH_DEFL_DATA.....	1213
0x12 - FLASH_DEFL_END.....	1213
0x13 – SPI_FLASH_MD5.....	1213
0xD0 – ERASE_FLASH.....	1213
0xD1 – ERASE_REGION.....	1213
0xD2 – READ_FLASH.....	1213
0xD3 – RUN_USER_CODE.....	1213
The flasher_stub.....	1213
Using Node-JS for an esptool.....	1215
Esptool and SPI flash.....	1215
Forums.....	1216
Reference documents.....	1216
Github.....	1217
Github quick cheats.....	1217
Installing Ubuntu on VirtualBox.....	1218
Single board computer comparisons.....	1224
Areas to Research.....	1224





## Introduction

Howdy Folks,

I've been working in the software business for over 30 years but until recently, hadn't been playing directly with Micro Processors. When I bought a Raspberry PI and then an Arduino, I'm afraid I got hooked. In my house I am surrounded by computers of all shapes, sizes and capacities ... any one of them with orders of magnitude more power than any of these small devices ... however, I still found myself fascinated.

When I stumbled across the ESP8266 in early 2015, it piqued my interest. I hadn't touched C programming in decades (I'm a Java man these days). As I started to read what was available in the way of documentation from the excellent community surrounding the device, I found that there were only small pockets of knowledge. The best source of information was (and still is) the official PDFs for the SDK from Espressif (the makers of the ESP8266) but even that is quite "light" on examples and background. As I studied the device, I started to make notes and my pages of notes continued to grow and grow. About a year later, the ESP32 found its way into my possession.

This book (if we want to call it that) is my collated and polished version of those notes. Rather than keep them to myself, I offer them to all of us in the ESP32 community in the hope that they will be of some value. My plan is to continue to update this work as we all learn more and share what we find in the community forums. As such, I will re-release the work at regular intervals so please check back at the book's home page for the latest.

As you read, make sure that you fully understand that there are undoubtedly inaccuracies, errors in my understanding and errors in my writing. Only by feedback and time will we be able to correct those. Please forgive the grammatical errors and spelling mistakes that my spell checker hasn't caught.

Please don't email me directly with technical questions. Instead, let us use the forum and ask and answer the questions as a great community of ESP32 minded enthusiasts, hobbyists and professionals.



Neil Kolban

Texas, USA

## Important Documentation Notes – ESP8266 and ESP32

At the start of 2015 I released a book of notes on ESP8266 and the ESP32 was still a long way off. At the time we knew very little about the ESP32 and my initial thinking was that I would cover **both** the ESP8266 and the ESP32 in one book. Now that we have the ESP32 it has become obvious that the distinctions between that device and the ESP8266 are far too great to be accommodated in one document. If we tried to merge the two we would be forever reading that "this applies to ESP8266" and "that applies to ESP32". As such, this book is explicitly for the ESP32. However ... there is currently a catch. Since there is indeed a goodly amount of material that is common to both devices, rather than start from scratch on a new book, I have taken the ESP8266 book as a base and am working through **this** book reworking it for ESP32 exclusivity. This is a work in progress. I have added the majority of what is new in ESP32 but haven't yet gotten to removing much of what is ESP8266 specific. As such, when you read this work, you will have to pay attention because some of the story is ESP8266 only and will either be removed or reworked over the period ahead.

## Overview

A micro controller is an integrated circuit that is capable of running programs. There are many instances of those on the market today from a variety of manufacturers. The prices of these micro controllers keeps falling. In the hobbyist market, an open source architecture called "Arduino" that uses the Atmel range of processors has caught the imagination of countless folks. The boards containing these Atmel chips combined with a convention for connections and also a free set of development tools has lowered the entry point for playing with electronics to virtually nill. Unlike a PC, these processors are extremely low end with low amounts of ram and storage capabilities. They won't be replacing the desktop or laptop any time soon. For those who want more "oomph" in their processors, the folks over at Raspberry PI have developed a very cheap (~\$45) board that is based on the ARM processors that has much more memory and uses micro SD for persistent data storage. These devices run a variant of the Linux operating system. I'm not going to talk further about the Raspberry PI as it is in the class of "computer" as opposed to microprocessor.

These micro controllers and architectures are great and there will always be a place for them. However, there is a catch ... and that is networking. These devices have an amazing set of capabilities including direct electrical inputs and outputs (GPIOs) and support for a variety of protocols including SPI, I2C, UART and more, however, few of them so far come with wireless networking included.

No question (in my mind) that the Arduino has captured everyone's attention. The Arduino is based on the Atmel chips and has a variety of physical sizes in its open hardware footprints. The primary micro controller used is the ATmega328. One can find instances of these raw processors on eBay for under \$2 with fully constructed boards containing them for under \$3. This is 10-20 times cheaper than the Raspberry PI. Of course, one gets dramatically less than the Raspberry PI so comparison can become odd ... however if what one wants to do is tinker with electronics or make some simple devices that connect to LEDs, switches or sensors, then the functional features needed become closer.

Between them, the Arduino and the Raspberry PI appear to have all the needs covered. If that were the case, this would be a very short book. Let us add the twist that we started with ... wireless networking. To have a device move a robot chassis or flash LED patterns or make some noises or read data from a sensor and beep when the temperature gets too high ... these are all great and worthy projects. However, we are all very much aware of the value of the Internet. Our computers are Internet connected, our phones are connected, we watch TV (Netflix) over the Internet, we play games over the Internet, we socialize (??) over the Internet ... and so on. The Internet has become such a basic commodity that we would laugh if someone offered us a new computer or a phone that lacked the ability to go "on-line".

Now imagine what a micro controller with native wireless Internet could do for us? This would be a processor which could run applications as well as or better than an Arduino, which would have GPIO and hardware protocol support, would have RAM and flash memory ... but would have the killer new feature that it would also be able to form Internet connections. And that ... simply put ... is what the ESP32 device is. It is an alternative microprocessor to the ones already mentioned but also has WiFi and TCP/IP (Transmission Control Protocol / Internet Protocol) support already built in. What is more, it is also not much more expensive than an Arduino. Searching eBay, we find ESP32 modules around the \$6 price point.

## **The ESP32**

The ESP32 is the name of a micro controller designed by Espressif Systems. Espressif is a Chinese company based out of Shanghai. The ESP32 advertises itself as a self-contained WiFi networking solution offering itself as a bridge from existing micro controllers to WiFi ... and ... is also capable of running self contained applications.

Volume production of the ESP32 didn't start until the later part of 2016 which means that, in the scheme of things, this is a brand new entry in the line-up of processors. And ... in our technology hungry world, new commonly equates to interesting. A couple of years after IC production, 3<sup>rd</sup> party OEMs are taking these chips and building "breakout

boards" for them. If I were to give you a raw ESP32 straight from the factory, it is unlikely we would know what to do with one. They are very tiny and virtually impossible for hobbyists to attach wires to allow them to be plugged into breadboards. Thankfully, OEMs bulk purchase the ICs, design basic circuits, design printed circuit boards and construct pre-made boards with the ICs pre-attached immediately ready for our use. It is these boards that capture our interest and that we can buy for a few dollars on eBay.

There are a variety of board styles available but from a programming perspective, they are all the same.

See also:

- [ESP32 Data sheet](#)

## The ESP32 specification

When we look at a new electronic device, we are always interested in its specifications. This is the set of characteristics as described by the manufacturer. Sometimes it is immediately obvious to us what a specification item means and for others, it takes some time to appreciate its ramifications. Here is a summary list of the core ESP32 items:

Attribute	Details
Voltage	3.3V
Current consumption	Unknown
Flash memory attachable	Module based
Processor	Tensilica L108 32 bit
Processor speed	Dual 160MHz
RAM	520K
GPIOs	34
Analog to Digital	7
802.11 support	11b/g/n/e/i
Bluetooth	BLE
Maximum concurrent TCP connections	16
SPI	3
I2S	2
I2C	2
UART	3

The ESP32 is a dual core processor running the Xtensa LX6 instructions. The cores are called "PRO\_CPU" and "APP\_CPU".

The question of determining how long an ESP32 can run on batteries is an interesting one. The current consumption is far from constant. When transmitting at full power, it can consume 260mA but when in a deep sleep, it only need 20uA. That is quite a difference. This means that the run-time of an ESP32 on a fixed current reservoir is not just a function of time but also of what it is doing during that time ... and that is a function of the program deployed upon it.

The ESP32 is designed to be used with a partner memory module and this is most commonly flash memory. Most of the modules come with some flash associated with them. Realize that flash has a finite number of erases per page before something fails. They are rated at about 10,000 erases. This is not normally an issue for configuration change writes or daily log writes ... but if your application is continually writing new data extremely fast, then this may be an issue and your flash memory will fail.

### ESP32 variants

The ESP32 has variants. Primarily these relate to how many cores (1 or 2) and whether there is embedded flash (yes/no). The various available parts are:

- ESP32-D0WDQ6
- ESP32-D0WD
- ESP32-D2WD
- ESP32-S0WD
- ESP32-PICO-D4

The part number of the ESP32 encodes its details:

ESP32 - <Core> - <Embedded Flash> - <Connection> - <Package>

This then expands to:

Part	Cores	Embedded Flash	Connection	Package
ESP32-D0WDQ6	2	N/A	WiFi + BT/BLE	QFN 6*6
ESP32-D0WD	2	N/A	WiFi + BT/BLE	QFN 5*5
ESP32-D2WD	2	16MBit	WiFi + BT/BLE	QFN 5*5
ESP32-S0WD	1	N/A	WiFi + BT/BLE	QFN 5*5

These parts refer to the raw ESP32 integrated circuits found on modules.

## Modules

At the time of writing, the ESP32 has only recently become generally available, as such there are still relatively few modules to be bought.

### ESP-WROOM-32

A module called the ESP-WROOM-32 is available from Espressif that contains an ESP32 plus accompanying supporting hardware such as 4MBytes flash memory. Don't mistake this for a breadboard friendly device ... this is much more oriented to those with good electronics skills that wish to embed an ESP32 in a specific project. The module is only 18mm x 25.5mm and has pin spacings at the 1.27mm pitch. This is an extremely small spacing.



The fantastic web site called PIGHIXX provides the most top quality pin-out images I have ever seen. Please visit their site. They have pin-outs for almost every conceivable device I have ever wanted to know about.

Here is a schematic of the current device:

# ESP32 PINOUT

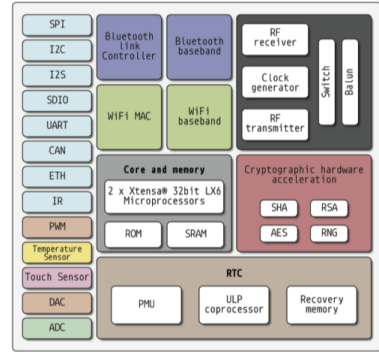
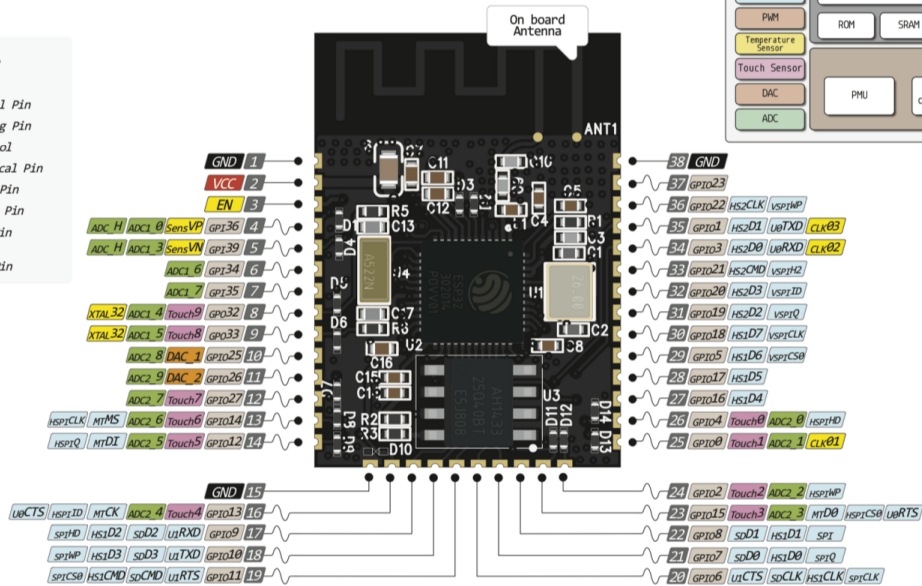

<http://esp32.com/>



The WROOM-32 uses 6 GPIO pins for driving the external flash and these must **not** be used for other purposes. They are off limits. The pins are GPIO6, GPIO7, GPIO8, GPIO9, GPIO10 and GPIO11.

See also:

- [ESP-WROOM-32 Datasheet](#)
- [Adafruit – seller of devices in US](#)
- [ESP-WROOM-32 Home Page](#)

## ESP32-DevKitC

With the release of the ESP32, Espressif have released their own module for exposing the ESP32 to more consumers. The board they have produced is called the "ESP32-DevKit" and is considered bread-board friendly.



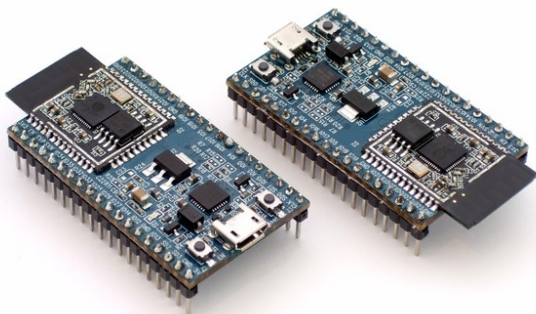

The board contains headers for the ESP32 as well as a micro USB adapter and two buttons called enable and boot. These buttons can be used to "flash" or "download" new application code into the module. To perform this task, hold the "EN" button down while pressing and releasing "Boot".

The pin out of the module is shown in the following image:

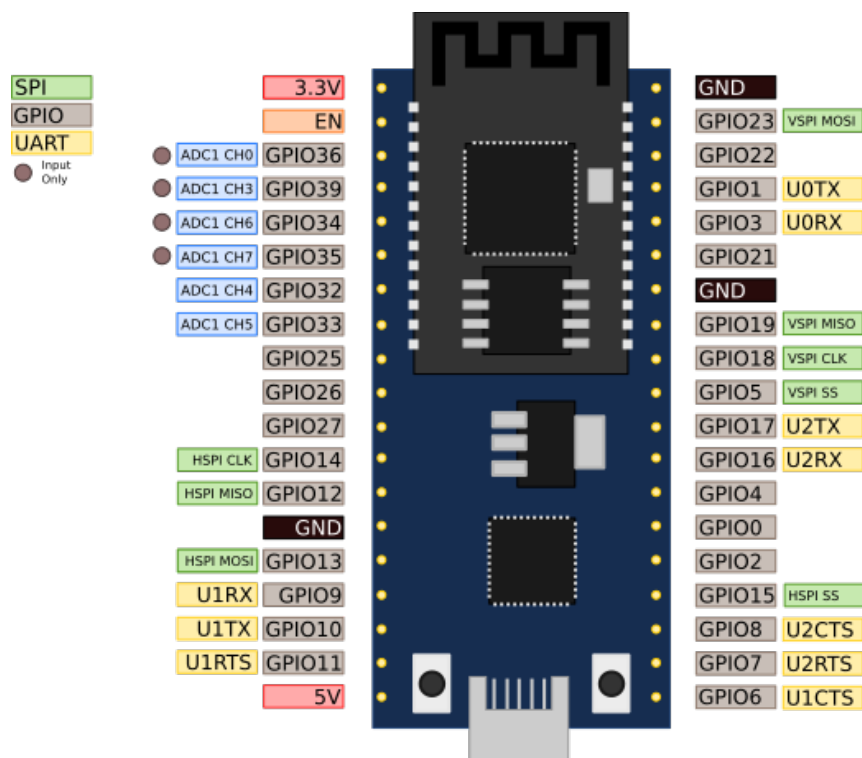

To reboot the device, pulse EN low. If GPIO0 is high, the device will normal boot while if GPIO0 is low, it will boot into flash mode allowing us to upload a new application into the device's flash storage.

This module uses the CP2102 for USB to UART and has a maximum baud rate of 921600.

See also:

- [ESP32-DevKitC – Getting Started Guide](#)
- [ESP32-DevKitC home page](#)
- [Adafruit reseller](#)

## ESP-WROVER-KIT

The ESP-WROVER-KIT is the be-all and end-all of ESP32 development. It is pricier than the other modules coming in at about \$50, however it is without question the most "robust" module currently available. It sports an LCD display, a socket for a camera, an on/off switch, a micro-sd connector, an RGB LED and many broken out connector pins.

The pins are broken out both on the front and rear.

This module is not at all bread-board friendly but that should be inherently understood from its purpose.



Here is the schematic of the USB interface:

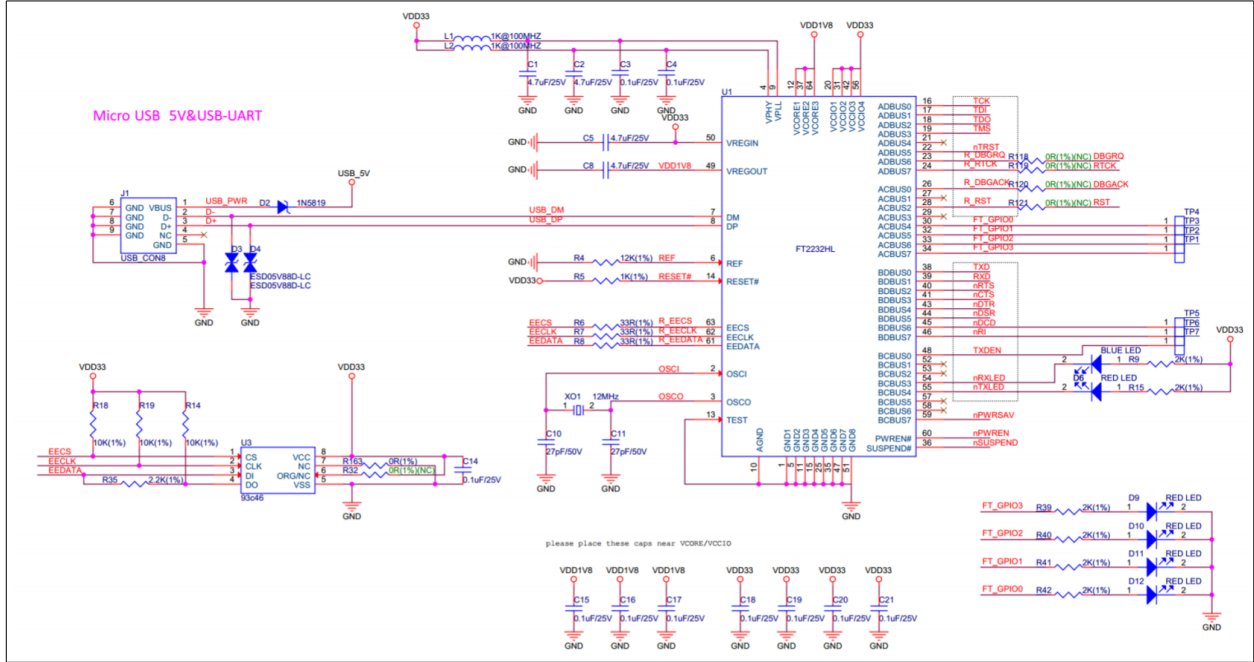

The LED anode pins are connected to IO0, IO2 and IO4.

Red	GPIO0	1 = on, 0 = off
Green	GPIO2	1 = on, 0 = off
Blue	GPIO4	1 = on, 0 = off

The camera is connected as follows:

Function	Pin
SIO_C	IO27
SIO_D	IO26
VSYNC	IO25
HREF	IO23
PCLK	IO22
XCLK	IO21
RESET	IO2
D0	IO4
D1	IO5
D2	IO18
D3	IO19
D4	IO36
D5	IO39
D6	IO34
D7	IO35
PWDN	GND

The LCD screen is SPI attached at:

Function	Pin
RESET	IO18
CLK	IO19
D/C	IO21
CS	IO22
MOSI	IO23
MISO	IO25
Backlight?	IO5

There is an RGB led attached to GPIO 0, GPIO 2 and GPIO 4 (Blue)

The module can be powered from an external 2.5m power source (5V) or from USB.  
There is a jumper which **must** be in place to select which is enabled.

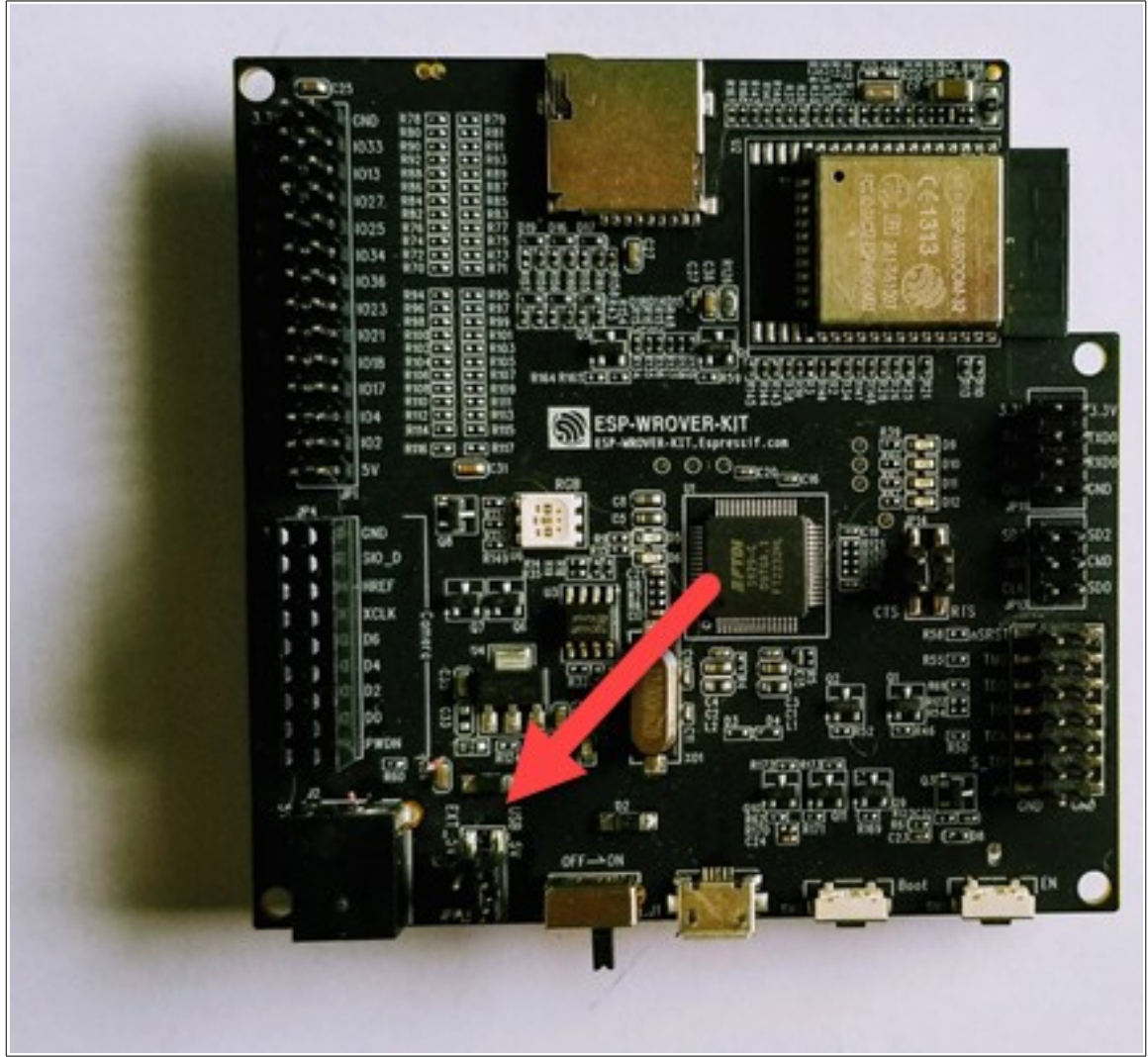

In addition, you should also enable the UARTs with two jumpers here:

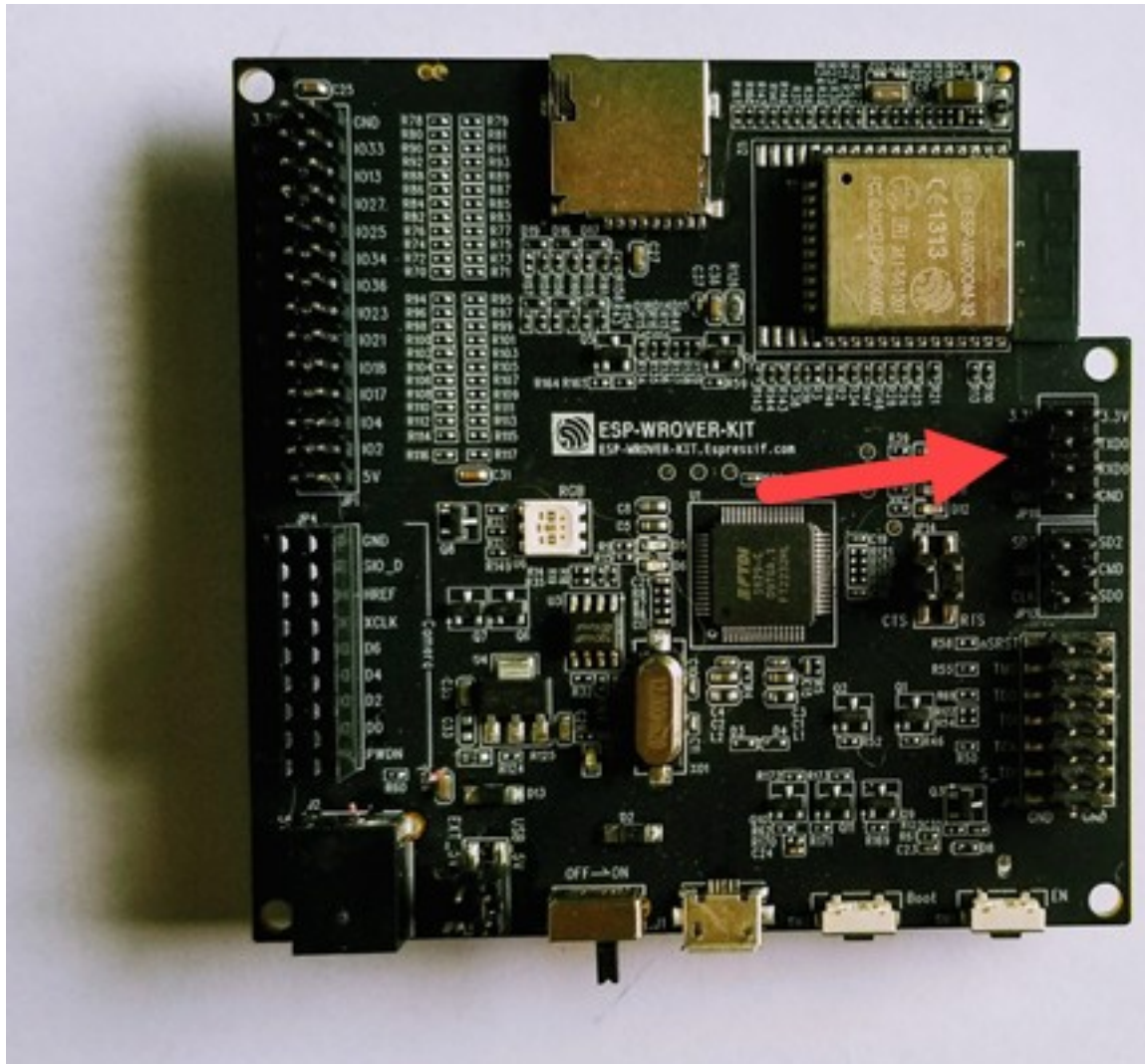

There have been a number of releases of the WROVER board. Unfortunately, determining which board you have is not the easiest task because the identity isn't on the board. The following are good indications:

- red board, female camera header – V1
- black (shiny) board, male camera header – V2
- black (matte) board, female camera header – V3

See also: [ESP32 Modules and Boards](#) for good pictures to aid in identification.

The USB device is an FTDI2232HL. This manifests as two serial ports. On Linux these are `/dev/ttyUSB0` and `/dev/ttyUSB1`. It is `/dev/ttyUSB1` that we wish to use for console and flashing.

There are two buttons on the boards labeled `EN` and `Boot`. Pressing EN brings the EN pin low.

See also:

- [ESP-WROVER-KIT Home Page](#)
- [ESP-WROVER-KIT Getting Started Guide](#)
- [Complete Schematic – V1](#)
- [Complete Schematic – V2](#)
- [Complete Schematic – V3](#)
- [Adafruit reseller](#)
- [FTDI – FT2232H home page](#)

### The SparkFun ESP32 thing

SparkFun make an ESP32 board called the "ESP32 Thing".

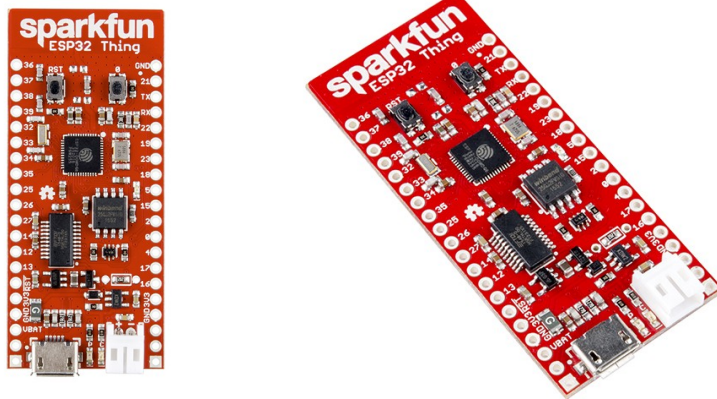

One of the distinguishing features of this board is the built in battery charger socket. We can use this board with a LIPO battery and charge that battery at the same time.

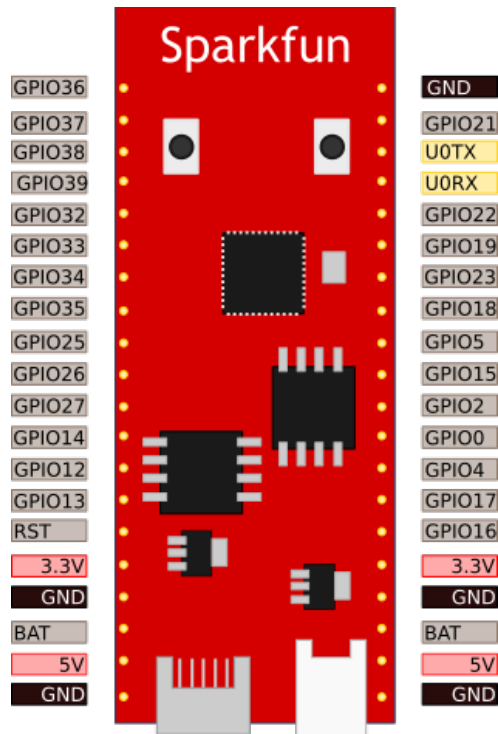

The width of the Sparkfun board allows it to sit in a breadboard with one row open either side of it. This makes it more convenient for quick prototyping.

See also:

- [SparkFun ESP32 Thing](#)

## Connecting to the ESP32

The ESP32 is a WiFi device and hence we will eventually connect to it using WiFi protocols but some bootstrapping is required first. The device doesn't know what network to connect to, which password to use and other necessary parameters. This of course assumes we are connecting as a station, if we wish the device to be an access point or we wish to load our own applications into it, the story gets deeper. This implies that there is a some way to interact with the device other than WiFi and there is ... the answer is UART (Serial). The ESP32 has a dedicated UART interface with pins labeled TX and RX. The TX pin is the ESP32 transmission (outbound from ESP32) and the RX pin is used to receive data (inbound into the ESP32). These pins can be connected to a UART partner. By far the easiest and most convenient partner for us is a USB → UART converter. These are discussed in detail later in the book. For now let us assume that we have set those up. Through the UART, we can attach a terminal emulator to send keystrokes and have data received from the ESP32 displayed as characters on the



screen. A second purpose of the UART is to receive binary data used to "flash" the flash memory of the device to record new applications for execution. There are a variety of technical tools at our disposal to achieve that task.

When we use a UART, we need to consider the concept of a baud rate. This is the speed of communication of data between the ESP32 and its partner. During boot, the ESP32 attempts to automatically determine the baud rate of the partner and match it. It assumes a default of 115200 and if you have a serial terminal attached, you will see a message like:

```
???
```

if it is configured to receive at 115200.

When connected to a Windows 10 machine via micro USB, it shows up as a serial device:



The default serial baud rate is 115200.

Once the ESP32 is serially connected, we typically want to attach a monitor or terminal emulator against the device. The ESP-IDF framework provides a nice technique to achieve that. We can run the command "make monitor". This launches a monitor tool that tails the ESP32 serial output. This tool is based on "miniterm" which is part of the "PySerial" package. We can terminate miniterm with `CTRL+]`.

From a Linux environment, we see the serial port (usually) as `/dev/ttyUSB0`. If we install the "screen" application, we can then connect a terminal using:

```
$ screen /dev/ttyUSB0 115200
```

To exit screen, enter "`CTRL+A`" followed by "`:quit`".

An alternative to `screen`, we also have "`cu`":

```
$ cu -l /dev/ttyUSB0 -s 115200
```

To terminate the program enter "`~.`".

Another program is "`minicom`":

```
$ minicom --baudrate 115200 --device /dev/ttyUSB0
```

And of course, since the serial port is just a stream of characters, there is nothing to prevent you from simply running "`cat`" against it:

```
$ cat /dev/ttyUSB0
```

If we are not sure about the settings of the serial port, we can run:

```
$ stty -F /dev/ttyUSB0 -a
```

which will return the current settings. Following a flash, you may need to change some setting to perform a simple cat:

```
$ stty -F /dev/ttyUSB0 ispeed 115200 ospeed 115200 min 100 ixon
```

See also:

- [USB to UART converters](#)
- [Loading a program](#)
- [Screen user's manual](#)
- [PySerial – miniterm](#)
- [man\(1\) – stty](#)

## Assembling circuits

Since the ESP32 is an actual electronic component, some physical assembly is required. This book will not attempt to cover non-ESP32 electronics as that is a very big and broad subject in its own right. However, what we will do is describe some of the components that we have found extremely useful while building ESP32 solutions.

### USB to UART converters

You can't program an ESP32 without supplying it data through a UART. The easiest way to achieve this is through the use of a USB to UART converter. I use the devices that are based upon the CP2102 which can be found cheaply on eBay for under \$2 each. Another popular brand are the devices from Future Technology Devices International (FTDI). You will want at least two. One for programming and one for debugging. I suggest buying more than two just in case ...

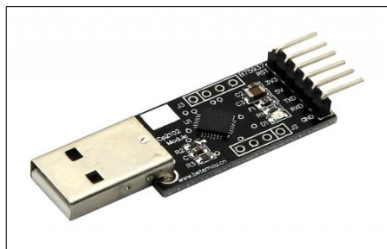

When ordering, don't forget to get some male-female USB extender cables as it is unlikely you will be able to attach your USB devices to both a breadboard and the PC at the same time via direct connection and although connector cables will work, plugging into the breadboard is just so much easier. USB connector cables allow you to easily

connect from the PC to the USB socket to the UART USB plug. Here is an image of the type of connector cable I recommend. Get them with as short a cable length as possible. 12-24 inches should be preferred.



When we plug in a USB → UART into a Windows machine, we can learn the COM port that the new serial port appears upon by opening the Windows Device Manager. There are a number of ways of doing this, one way is to launch it from the DOS command window with:

```
mmc devmgmt.msc
```

Under the section called Ports (COM & LPT) you will find entries for each of the COM ports. The COM ports don't provide you a mapping that a particular USB socket is hosting a particular COM port so my poor suggestion is to pull the USB from each socket one by one and make a note of which COM port disappears (or appears if you are inserting a USB).

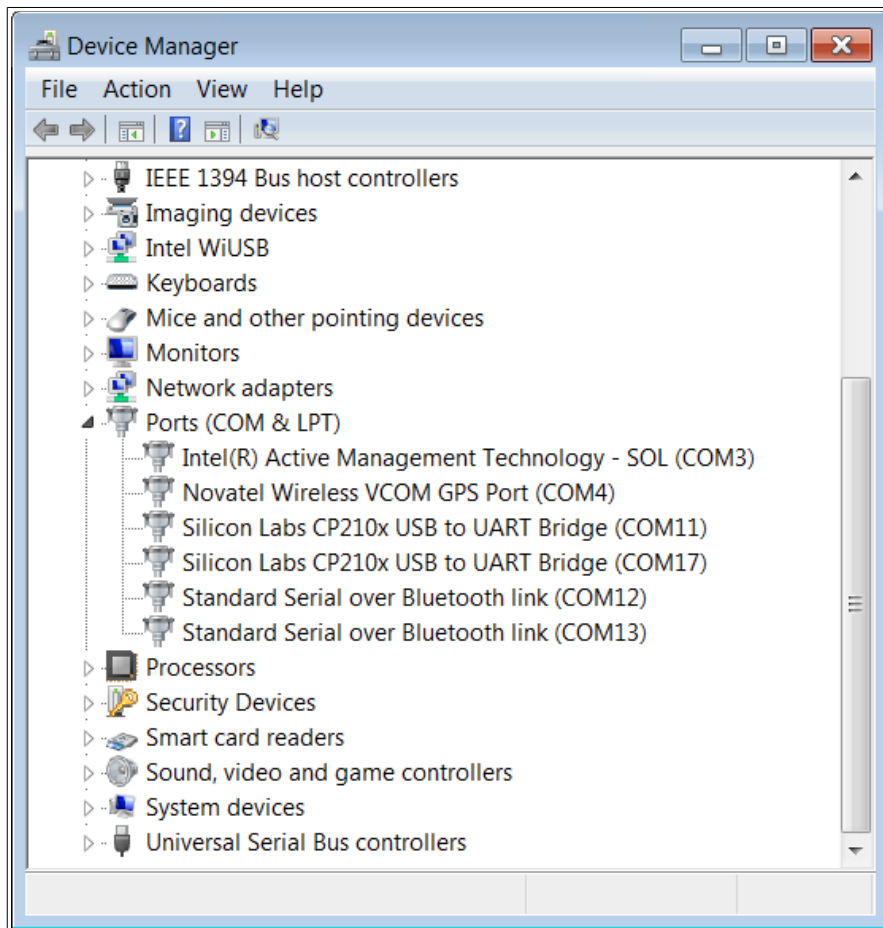

See also:

- [Connecting to the ESP32](#)
- [Working with UART/serial](#)

## Breadboards

I find I can never have too many breadboards. I suggest getting a few full size and half size boards along with some 24 AWG connector wire and a good pair of wire strippers. Keep a trash bin close by otherwise you will find yourself knee deep in stripped insulation and cut wire parts before you know it. I also recommend some Dupont male-male pre-made wires. Ribbon cable can also be useful.

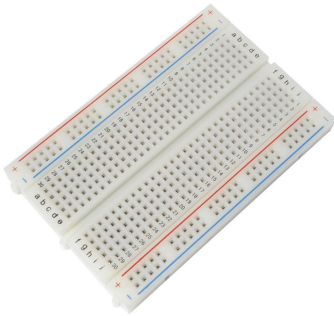

## Power

We need electricity to get these devices working. I choose the MB102 breadboard attachable power adapters. These can be powered from an ordinary wall-wart (mains adapter) or from USB. It appears that the plug for wall-wart power is 2.1mm and center positive however I strongly suggest that you read your specific supplier's data sheets very carefully. There is also a potential concern that the barrel socket is wired in parallel with the USB input which could mean that if you attach a high voltage input (eg. 12V) while also having a USB source connected, you may very well damage your USB device. The devices have a master on/off power switch plus a jumper to set 3.3V or 5V outputs. You can even have one breadboard rail be 3.3V and the other 5V ... but take care not to apply 5V to your ESP32. By having two power rails, one at 3.3V and the other at 5V, you can power both the ESP32 and devices/circuits that require 5V.



When the ESP32 starts to transmit over wireless, that can draw a lot of current which can cause ripples in your power supply. You may also have other sensors or devices connected to your supply as well. These fluctuations in the voltage can cause problems. It is strongly recommended that you place a 10 micro farad capacitor between +ve and -ve as close to your ESP32 as you can. This will provide a reservoir of power to even out any transient ripples. This is one of those tips that you ignore at your peril. Everything may work just fine without the capacitor ... until it doesn't or until you start getting intermittent problems and are at a loss to explain them. Let me put it this way, for the few cents it costs and the zero harm it does, why not?

## Multi-meter / Logic probe / Logic Analyzer

When your circuit doesn't work and you are staring at it wondering what is wrong, you will be thankful if you have a multi-meter and a logic probe. If your budget will stretch, I also recommend a USB based logic analyzer such as those made by Saleae. These allow you to monitor the signals coming into or being produced by your ESP32. Think of this as the best source of debugging available to you. Not only can these devices display signals over time, the software also allows us to specify the protocol being used and the content of the signal displayed at a higher level with interpretation.

An open source tool called Sigrok is available for decoding and displaying the output of the logic analyzer. On windows, this uses a driver tool called Zadig for interfacing with the capture device.

See also:

- [Saleae logic analyzers](#)
- [YouTube: ESP32 and logic analyzers](#)
- [Sigrok](#)
- [Zadig](#)

## Sundry components

You will want the usual set of suspects for sundry components including LEDs, resistors, capacitors and more.

## Physical construction

When you have bread-boarded your circuit and written your application, there may come a time where you wish to make your solution permanent. At that point, you will need a soldering iron, solder and some strip-board. I also recommend some female header sockets so that you don't have to solder your ESP32 directly into the circuits. Not only does this allow you to reuse the devices (should you desire) but in the unfortunate event that you fry one, it will be easier to replace.

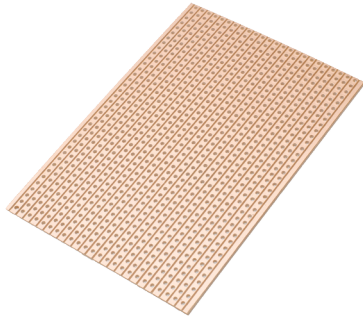

### **Configuration for flashing the device**

Later on in the book you will find that when it comes time to flash the device with your new applications, you will have to set some of the GPIO pins to be low and then reboot. This is the indication that it is now ready to be flashed. Obviously, you can build a circuit that you use for flashing your firmware and then place the device in its final circuit but you will find that during development, you will want to flash and test pretty frequently. This means that you will want to use jumper wires and to allow you to move the links of pins on your breadboards from their "flash" position to their "normal use" position.

## Programming for ESP32

The ESP32 allows you to write applications that can run natively on the device. You can compile applications written in the C programming language and deploy them to the device through a process known as flashing. In order for your applications to do something useful, they have to be able to interact with the environment. This could be making network connections or sending/receiving data from attached sensors, inputs and outputs. In order to make that happen, the ESP32 contains a core set of functions that we can loosely think of as the operating system of the device. The services of the operating system are exposed to be called from your application providing a contract of services that you can leverage. These services are fully documented. In order to successfully write applications for deployment, you need to be aware of the existence of these services. They become indispensable tools in your tool chest. For example, if you need to connect to a WiFi access point, there is an API for that. To get your current IP address, there is an API for that and to get the time since the device was started, there is an API for that. In fact, there are a LOT of APIs available for us to use. The good news is that no-one is expecting us to memorize all the details of their use. Rather it is sufficient to broadly know that they exist and have somewhere to go when you want to look up the details of how to use them.

To sensibly manage the number and variety of these exposed APIs, we can collect sets of them together in meaningful groups of related functions. This gives us yet another and better way to manage our knowledge and learning of them.

The primary source of knowledge on programming the ESP32 is the ESP32 SDK API Guide. Direct links to all the relevant documents can be found at Reference documents.

See also:

- [Espressif Systems](#) – Manufacturers of the ESP8266
- [Espressif Bulletin Board System](#) – Place for SDKs, docs and forums

## Espressif IoT Development framework

For the ESP32, a framework has been developed by Espressif called the IoT Development Framework which has become commonly known as "ESP-IDF". It can be found on Github here:

<https://github.com/espressif/esp-idf>

The documentation for this can be found in the esp-idf/docs folder. The documentation is very good and should always be read thoroughly. This book should not be considered the primary source for this information.



Here is a walk through of building an environment on Linux. The full details are found in the doc file called "linux-setup.rst". Our environment build will be broken down into a number of distinct parts. The first is the generation of the tool-chain which are the tools necessary to compile the programs:

```
$ cd ~
$ mkdir esp32
$ cd esp32
$ sudo apt-get install git wget make libncurses-dev flex bison gperf python python-serial
# // >> Here we download and install an x86-64 build chain (compilers)
$ wget https://dl.espressif.com/dl/xtensa-esp32-elf-linux64-1.22.0-80-g6c4433a-5.2.0.tar.gz
$ tar -xvf xtensa-esp32-elf-linux64-1.22.0-80-g6c4433a-5.2.0.tar.gz
$ sudo mv xtensa-esp32-elf /opt
$ export PATH=/opt/xtensa-esp32-elf/bin:$PATH
# // << End of build chain install
```

With the tools in place, what remains is the creation of the development environment using the ESP-IDF framework:

```
$ git clone https://github.com/espressif/esp-idf.git esp-idf
$ cd esp-idf/
$ git checkout v3.0
$ git submodule update --init --recursive
$ export IDF_PATH=~/.esp32/esp-idf
```

At this point, we should have all the ingredients necessary for building an application. The recommended way to build an application is to clone the Espressif template app and use that as the basis for your own work.

```
$ cd ~/.esp32
$ mkdir apps
$ cd apps
$ git clone https://github.com/espressif/esp-idf-template.git myapp
$ cd myapp
$ make menuconfig
```

At this point an attractive configuration menu is presented that allows us to customize our build environment.

We are now ready to compile our application:

```
$ make
```

The targets that we can make are:

- `make menuconfig` – Run the configuration menu.
- `make deconfig` –
- `make all` – Compile all the code.
- `make flash` – Flash the code to the device.
- `make clean` – Clean the build removing anything that was present previously.
- `make monitor` – Connect to the ESP32 serial port and display messages.
- `make erase_flash` – Erase the flash on the ESP32.
- `make app` –
- `make app-flash` –
- `make app-clean` –
- `make bootloader` –
- `make bootloader-flash` –
- `make bootloader-clean` –
- `make partition-table` –

It is important to note that the ESP-IDF is an evolving platform. It is being actively worked upon by Espressif and the community. What that means is that from time to time you should review how current your ESP-IDF build is and consider replacing it with a newer build. Realize that this *may* result in some rework to your applications, especially if build procedures or APIs change. If you are building production level versions, make a note of the dates of download from Github so that if needed, you can checkout those specific versions which may have worked successfully for you in the past.

I recommend using "`doxygen`" to build an HTML document tree of the content of the IDF. If you don't have `doxygen` installed run:

```
$ sudo apt-get install doxygen
```

Once installed, create a `doxygen` configuration file by running:

```
$ doxygen -g
```

The result will be a file called "Doxyfile".

Some of the doxygen configuration changes you will want to make will include:

- INPUT=<Root of IDF Install>/components
- OUTPUT\_DIRECTORY=output
- OPTIMIZE\_OUTPUT\_FOR\_C=YES
- RECURSIVE=YES
- GENERATE\_HTML=YES
- GENERATE\_LATEX=NO
- EXTRACT\_ALL=YES
- EXTRACT\_PRIVATE=YES
- EXTRACT\_PACKAGE=YES
- EXTRACT\_STATIC= YES
- EXTRACT\_LOCAL\_CLASSES =YES
- EXTRACT\_LOCAL\_METHODS =YES
- CLASS\_DIAGRAMS=NO
- HAVE\_DOT=NO

See also:

- [Github: espressif/esp-idf-template](#)
- [Github: espressif/esp-idf](#)
- [ESP-IDF Getting Started Guide](#)

## Application entry point

When your custom ESP32 application boots within an ESP32 device, it has to start somewhere and that somewhere is called the "application entry point". The entry point into your custom ESP32 application is a function called `app_main` with the following signature:

```
int app_main(void)
```

It is your responsibility to implement this function in your C code and provide the logic that is performed. If you are writing C++ applications, take care to declare the function as having C linkage. For example you might code:

```
extern "C" {  
    int app_main(void);  
}
```

```
int app_main(void) {
    // Your code here
}
```

## How ESP-IDF works

When we type "make" in an ESP-IDF template project, the Makefile is executed. It does us no harm in understanding how this works.

The Makefile in our project template sets a variable called "PROJECT\_NAME" to the name of our project. It then includes the Makefile found at <IDF\_PATH>/make/project.mk and make processing continues.

We can run a make with verbosity switched on to see exactly what is performed:

```
$ make VERBOSE=1
```

The build performs the following major steps:

- build the "conf" tool found in <IDF>/tools/kconfig
- The various components are built including:
  - bt/libbt.a - Bluetooth
  - driver/libdriver.a – Access for GPIO
  - esp32/libesp32.a
  - expat/libexpat.a – A C library for parsing XML
  - freertos/libfreertos.a
  - json/libjson.a – A C library for working with JSON
  - log/liblog.a – Logging capabilities
  - lwip/liblwip.a – Implementation of TCP/IP
  - main/libmain.a
  - mbed/libmbedtls.a – SSL/TLS support
  - nvs\_flash/libnvs\_flash.a – Non Volatile storage
  - spi\_flash/libspi\_flash.a – SPI flash driver
  - tcpip\_adapter/libtcpip\_adapter.a – TCP/IP adapter
- Build the application

A source file compilation includes:

- -std=gnu99

- -Og
- -ggdb
- -ffunction-sections
- -fdata-sections
- -fstrict-volatile-bitfields
- -mlongcalls
- -nostdlib
- -MMD
- -MP
- -Wall
- -Werror
- -Wno-error=unused-function
- -Wno-error=unused-but-set-variable
- -Wno-error=unused-variable
- others

The last step is the one that is likely most useful to us. At a high level it runs:

- `xtensa-esp32-elf-gcc` – The C compiler
- `-nostdlib` – Don't include the standard C library
- `-L<directory>` - Include a bunch of directories looking for libraries
- `-u call_user_start_cpu0` – Specify the entry point into code
- `-Wl,--gc-sections`
- `-Wl,-static`
- `-Wl,--start-group`
- **Link with the following libraries:**
  - `-lbt`
  - `-lbt dm_app`
  - `-ldriver`
  - `-lesp32`
  - `-lhal.a`
  - `-lcrypto`

- -lcore
- -lnet80211
- -lphy
- -lrtc
- -lpp
- -lwpa
- **Do whatever -T says**
  - -T esp32\_out.ld
  - -T esp32.common.ld
  - -T esp32.rom.ld
  - -T esp32.peripherals.ld
- **Link with:**
  - -lexpat
  - -lfreertos
  - -Wl,--undefined=uxTopUsedPriority
  - -ljson
  - -llog
  - -llwip
  - -lMBEDTLS
  - /home/kolban/projects/esp32/esp-idf/components/newlib/lib/libc.a
  - /home/kolban/projects/esp32/esp-idf/components/newlib/lib/libm.a
  - -lnvs\_flash
  - -lspi\_flash
  - -ltcpip\_adapter
  - -lmain
  - -lgcc
  - -Wl,--end-group
  - -Wl,-EL
  - -o /home/kolban/projects/esp32/apps/myapp/build/app-template.elf
  - -Wl,-Map=/home/kolban/projects/esp32/apps/myapp/build/app-template.map

## Error handling

Most of the ESP32 functions we call can return an error indication in the event that something goes wrong. The result is an `esp_err_t` which can be treated as an integer. If the function call succeeded, then the return value is `ESP_OK`. Any other value is an error indication. A macro is available called `ESP_ERROR_CHECK()` which takes a statement as a parameter. The statement is expected to return an `esp_err_t`. If the return is other than `ESP_OK`, then an assertion is raised, the ESP32 halts and the statement is written to the console. We must include "`esp_err.h`" to use this capability.

The other codes defined that are values that can be returned from ESP-IDF API calls include:

Symbol	Value
<code>ESP_OK</code>	0
<code>ESP_FAIL</code>	-1
<code>ESP_ERR_NO_MEM</code>	257 (0x101)
<code>ESP_ERR_INVALID_ARG</code>	258 (0x102)
<code>ESP_ERR_INVALID_STATE</code>	259 (0x103)
<code>ESP_ERR_INVALID_SIZE</code>	260 (0x104)
<code>ESP_ERR_NOT_FOUND</code>	261 (0x105)
<code>ESP_ERR_NOT_SUPPORTED</code>	262 (0x106)
<code>ESP_ERR_TIMEOUT</code>	263 (0x107)

If you need to convert an error code into a string representation a sample code fragment can be found here: <https://github.com/nkolban/esp32-snippets/blob/master/error%20handling/fragments/espToError.c>

See also:

- ESP-IDF logging

## The build environment menu configuration

Within a project, we can create a configuration file that controls how the build of a project progresses. This configuration file (`sdkconfig`) has a very attractive menu configuration tool that can be opened by running:

```
$ make menuconfig
```

Note: I am especially impressed with this component of the ESP-IDF. An attention to detail and quality that makes configuration a lot nicer to use and less error prone than hand editing files.

After running the command we see a text based menu editor:

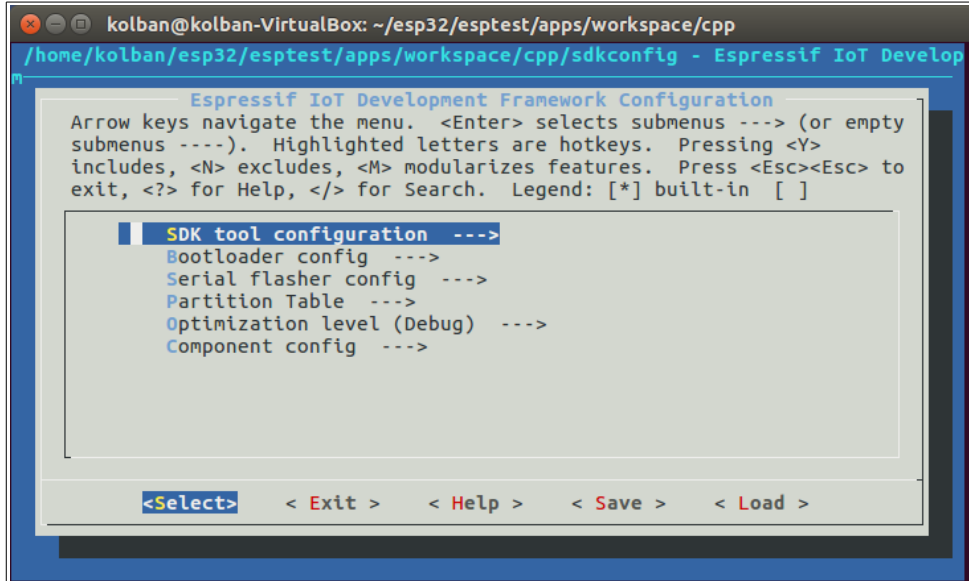

```
kolban@kolban-VirtualBox: ~/esp32/esptest/apps/workspace/cpp
/home/kolban/esp32/esptest/apps/workspace/cpp/sdkconfig - Espressif IoT Develop

Espressif IoT Development Framework Configuration
Arrow keys navigate the menu. <Enter> selects submenus ---> (or empty
submenus ----). Highlighted letters are hotkeys. Pressing <Y>
includes, <N> excludes, <M> modularizes features. Press <Esc><Esc> to
exit, <?> for Help, </> for Search. Legend: [*] built-in [ ]

  SDK tool configuration --->
    Bootloader config --->
    Serial flasher config --->
    Partition Table --->
    Optimization level (Debug) --->
    Component config --->

<Select>  < Exit >  < Help >  < Save >  < Load >
```

We can tab between major components and make changes. There is even selection context help assistance.

Under SDK tool configuration

- Compiler toolchain path/prefix – xtensa-esp32-elf-
- Python 2 interpreter – python

Under Bootloader config

- Bootloader log verbosity – Warning
- Build bootloader with Link Time Optimisation

Under Security features

- Enable secure boot in bootloader
- Enable flash encryption on boot

Under Serial flasher config

- Default serial port – /dev/ttyUSB0
- Default baud rate – 115200 baud
- Use compressed upload – false
- Flash SPI mode – DIO



- Flash SPI speed – 40MHz
- Flash size – 2MB
- Detect flash size when flashing bootloader
- Before flashing
- After flashing
- 'make monitor' baud rate

#### Under Partition Table

- Partition Table – Single factory app, no OTA

#### Under Compiler options

- Optimization Level – Debug (-Og)
- Assertion level – Enabled
- Enable C++ exceptions – No

#### Under Component config

- Application Level Tracing
  - Data Destination
  - FreeRTOS SystemView Tracing
- Amazon Web Services IoT Platform
- Bluetooth
- ESP32-specific
  - CPU frequency – 240MHz
  - Reserve memory for two cores – true
  - Use TRAX tracing feature – false
  - Core dump destination
  - Number of universally administered MAC address
  - System event queue size – 32
  - Event loop task stack size – 2048
  - Main task stack size – 4096
  - Inter-Processor Call (IPC) task stack size

- Standard-out outputs adds carriage return before newline – true
- Enable 'nano' formatting options for printf/scanf family
- UART for console output
- UART console baud rate
- Enable Ultra Low Power (ULP) Coprocessor
- Panic handler behavior – Print registers and reboot
- Make exception and panic handlers JTAG/OCD aware
- Interrupt watchdog
  - Interrupt watchdog timeout (ms)
- Task watchdog
  - Invoke panic handler when Task Watchdog is triggered
  - Task watchdog timeout (seconds)
  - Task watchdog watches CPU0 idle task
- Hardware brownout detect & reset
- Timers used for gettimeofday function
- RTC clock source
- Number of cycles for RTC\_SLOW\_CLK calibration
- Extra delay in deep sleep wake stub (in us)
- Main XTAL frequency
- Wi-Fi
  - Software controls WiFi/Bluetooth coexistence
  - Max number of WiFi RX buffers
  - Max number of WiFi dynamic RX buffers
  - Type of WiFi TX buffers
  - Max number of WiFi dynamic TX buffers
  - WiFi AMPDU
    - WiFi AMPDU TX BA window size
    - WiFi AMPDU RX BA window size
  - WiFi NVS flash

- PHY
  - Do phy calibration and store calibration data in NVS
  - Use a partition to store PHY init data
  - Max WiFi TX power
- Power Management
  - Support for power management
- Ethernet
  - Number of DMA TX buffers
  - Number of DMA RX buffers
  - Enable copy between Layer2 and Layer3
  - EMAC\_TASK\_PRIORITY
- FAT Filesystem support
  - OEM Code Page
  - Long filename support
  - Max long filename length
- FreeRTOS
  - Run FreeRTOS only on first core – true
  - Xtensa timer to use as the FreeRTOS tick source – Timer 0 (int (1000) tick rate (Hz))
  - Tick Rate (HZ)
  - Halt when an SMP-untested function is called
  - Check for stack overflow – Check by stack pointer value
  - Set a debug watchpoint as a stack overflow check
  - Enable backtrace from interrupt to task context
  - Number of thread local storage pointers – 3
  - FreeRTOS assertions – abort() on failed assertions
  - Stop program on scheduler start when JTAG/OCD is detected – true
  - Enable heap memory debug – false
  - Idle Task stack size

- ISR stack size
- Use FreeRTOS legacy hooks
- Maximum task name length
- Enable FreeRTOS static allocation API
- FreeRTOS timer task priority
- FreeRTOS timer task stack size
- FreeRTOS timer queue length
- Enable FreeRTOS trace facility
- Debug FreeRTOS internals – ?
- Heap memory debugging
- Log output
  - Default log verbosity – Warning
  - Use ANSI terminal colors in log output – true
- LWIP
  - Enable copy between Layer2 and Layer3 packets
  - Max number of open sockets – 4
  - Index for thread-local-storage pointer for lwip – 0
  - Enable SO\_REUSEADDR option – false
  - Enable SO\_RCVBUF option
  - Maximum number of NTP servers – 1
  - Enable fragment outgoing IP packets
  - Enable reassembly incoming fragmented IP packets
  - Enable an ARP check on the offered address
  - TCP/IP Task Stack Size
  - Enable PPP support
  - ICMP
    - Respond to multicast pings
    - Respond to broadcast pins
- mbedTLS

- TLS maximum message content length – 16384
- Enable mbedTLS debugging – false
- Enable hardware AES acceleration
- Enable hardware MPI (bignum) acceleration
  - Use interrupt for MPI operations
- Enable hardware SHA acceleration
- Enable mbedtls time
  - Enable mbedtls time data
- OpenSSL
  - Enable OpenSSL debugging
  - Select OpenSSL assert function
- PThreads
  - Default task priority
  - Default task stack size
- SPI Flash driver
  - Enable operation counters – false
  - Enable SPI flash ROM driver patched functions
- SPIFFS Configuration
  - Maximum Number of Partitions
  - SPIFFS Cache Configuration
  - Enable SPIFFS Page Check
  - Set Maximum GC Runs
  - Enable SPIFFS GC Statistics
  - Set SPIFFS Maximum Name Length
  - Enable SPIFFS Filesystem Magic
  - Enable Spiffs Filesystem Length Magic
  - Debug Configuration
    - Enable general SPIFFS debug

- Enable SPIFFS API debug
- Enable SPIFFS Garbage Cleaner debug
- Enable SPIFFS Cache debug
- Enable SPIFFS Filesystem Check debug
- Enable SPIFFS Filesystem Visualization
- tcpip adapter
  - IP Address lost timer interval (seconds)
- Wear Levelling
  - Wear levelling library sector size

After changing a configuration parameter, one should perform a complete clean rebuild of the ESP-IDF environment.

### Adding a custom ESP-IDF component

As you build projects, you may want to build your own custom components. To create a component, create a directory in the root of your application called "components" and within there, create a directory named after your new component. In that directory, we will construct our component. It should contain:

- component.mk
- <your source files>.c
- Kconfig (optional)

Should you wish to place source files in sub-directories beneath your component directory, you can do so and name the additional directories in "component.mk" using the `COMPONENT_SRCDIRS` variable. For example:

```
COMPONENT_SRCDIRS:=dir1 dir2
```

By default, this will compile all the C source files in the component directory and link them into a library for linking with your application. If you wish to name the source files to be compiled explicitly you can do so by naming the resulting object files using the `COMPONENT_OBJS` variable. For example:

```
COMPONENT_OBJS := file1.o file2.o dir1/file3.o
```

The `Kconfig` file contains details that are shown in the menu system shown by "`make menuconfig`". The format of this file is a configuration language which is called "Kconfig". The idea is that we wish to have a custom set of configuration options and we wish to be able to set/change the value of these options. The Kconfig file defines the existence of a set of options, their data types, their default values, the allowable values for an option and help text associated with an option. The "`make menuconfig`" then parses the set of distinct Kconfig files that it can find and creates a text/full-screen menu showing each of the options and navigation to set and change them.

Rather than show you all the possible options that can be set as one long huge list, we can create menus and sub-menus of options to allow the user of the configuration to drill down and locate the specific options that they might want to change.

It is described in a web file but at a high level, it has the following format:

```
menu "<Menu heading text>"
config <ITEM_NAME>
    <type>
    prompt "<text>"
    default <value>
    help
        help text
endmenu
```

A specific configuration item is given a name. For example we can define:

```
config OPTION1
```

This will create a new configuration option called `CONFIG_OPTION1`. Note that the "`CONFIG_`" prefix is added to each option automatically. Each option can have a type associated with it. The choices of types are:

- `bool` – A true/false value specified by "y" or "n".
- `tristate` – A boolean option that is either "y", "n" or not set.
- `string` – A text string.

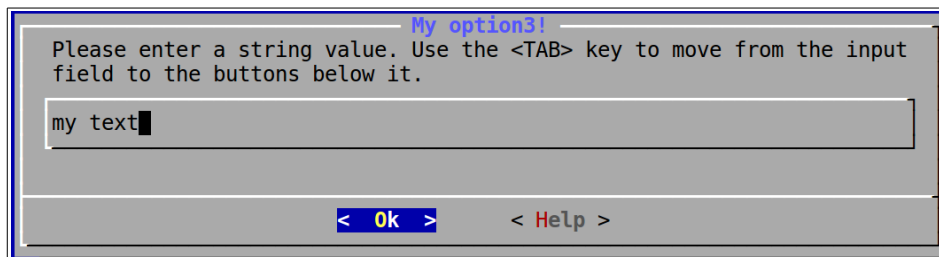

- `hex` – A hex number.

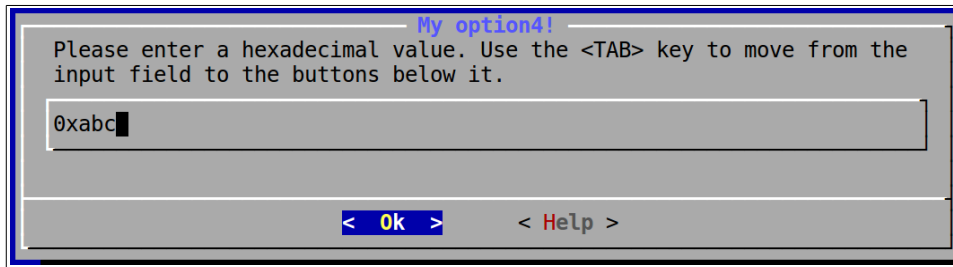

- `int` – An integer.

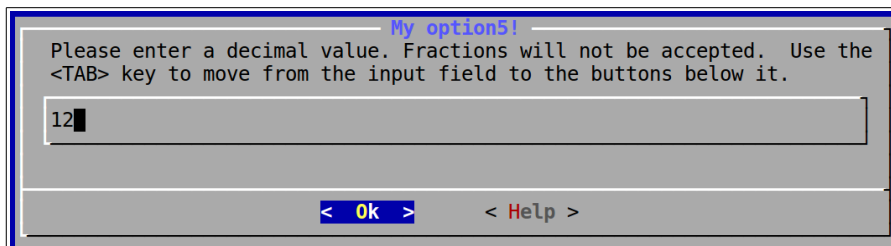

Following the definition of a configuration option, we can have prompt text. For example:

```
config OPTION1
    bool
    prompt "This is my prompt text!"
```

A default value can be supplied using the "default" option:

```
config OPTION1
    bool
    prompt "This is my prompt text!"
    default y
```

The prompt text is shown beside the current value of the option in the menu:

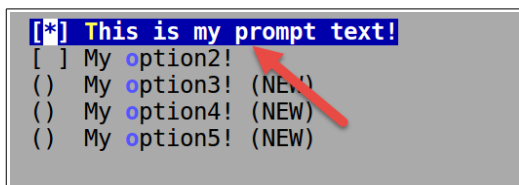

Help text can be provided which is shown as assistance to the user.

```
config OPTION1
    bool
    prompt "This is my prompt text!"
    default y
    help
```



This is my help text to select the correct value for OPTION1.

```
          This is my prompt text!
CONFIG_OPTION1:
This is my help text to select the
correct value for OPTION1.
Symbol: OPTION1 [=y]
Type : boolean
Prompt: This is my prompt text!
Location:
  -> Component config
  -> My Menu
Defined at /home/pi/projects/esp32/apps/v1/components/mycomp/Kconfig:

(100%)
< Exit >
```

Detailed documentation on the ESP-IDF build system and how to configure it can be found in the "[build\\_system.rst](#)" document in Github.

If you have defined your own constants, your code will need to include "sdkconfig.h" in order to be able to test the value of the menu defined entries. This file is generated by the ESP-IDF at compilation time from the "sdkconfig" file generated by running the menu system.

See also:

- [Kconfig language](#)
- The component.mk settings

## Working with memory

Heap based storage can allocated with `malloc()` and released with a corresponding call to `free()`. There are quite a number of ESP-IDF function that take pointers to storage as input. Unless these explicitly state that the data must be maintained then we can assume a deep copy for asynchronous function calls. With that in mind, the following is a legal pattern:

```
uint8_t* pMyData = malloc(size);
// populate data
esp_idf_function(pMyData);
free(pMyData);
```

Putting this into words, unless explicitly stated to the contrary, you can pass in a pointer to storage to an ESP-IDF function and assume that you are at liberty to release or otherwise re-use that storage on return from the ESP-IDF call. If the call needs the content that was in the storage at the time the function was called, it will have taken a copy of that data.

See also:

- [Heap management](#)

## Compiling

Application code for an ESP32 program is commonly written in C. Before we can deploy an application, we must compile the code into binary machine code instructions. Before that though, let us spend a few minutes thinking about the code.

We write code using an editor and ideally an editor that understands the programming language in which we are working. These editors provide syntax assistance, keyword coloring and even contextual suggestions. After we save our entered code, we compile it and then deploy it and then test it. This cycle is repeated so often that we often use a product that encompasses editing, compilation, execution and testing as an integrated whole. The generic name for such a product is an "Integrated Development Environment" or "IDE". There are instances of these both fee and free. In the free camp, my weapons of choice are Eclipse and Arduino IDE.

The Eclipse IDE is an extremely rich and powerful environment. Originally written by IBM, it was open sourced many years ago. It is implemented in Java which means that it runs and behaves identically across all the common platforms (Windows, Linux, OSx). The nature of Eclipse is that it is architected as a series of extensible plug-ins. Because of this, many contributors across many disciplines have extended the environment and it is now a cohesive framework for just about everything. Included in this mix is a set of plug-ins which, on aggregate, are called the "C Developers Tools" or "CDT". If one takes a bare bones Eclipse and adds the CDT, one now has a first rate C IDE. However, what the CDT does not supply (and for good reason) are the actual C compilers and associated tools themselves. Instead, one "defines" the tools that one wishes to use within the CDT and the CDT takes it from there.

For our ESP32 story, this means that if we can find (which we can) a set of C compiler tools that take C source and generate Xtensa binary, we can use CDT to build our programs.

To make things more interesting though, we need to realize that C is not the only language we can use for building ESP32 applications. We can also use C++ and assembly. You may be surprised that I mention assembly as that is as low level as we

can possibly get however there are odd times when we need just that (thankfully rarely) ... especially when we realize that we are pretty much programming directly to the metal. The Arduino libraries (for example) have at least one assembly language file.

For physical file types, the suffixes used for different file we will come across during development include:

- `.h` – C and C++ language header file
- `.c` – C language source file
- `.cpp` – C++ source file
- `.s` – Assembler source file
- `.o` – Object file (compiled source)
- `.a` – Archive library

To perform the compilations, we need a set of development tools.

My personal preference is the package for Eclipse which has everything pre-built and ready for use. However, these tools can also be downloaded from the Internet as open source projects on a piece by piece basis.

## Compilation

Let us imagine we have a `"main.c"` source file. How then can we properly compile that to get it ready for linking into an ESP32 binary? The Espressif documented mechanism is to use the ESP-IDF and that works great ... but there are times when we can't start with the Espressif make system but instead need to work in the opposite direction ... namely starting from an existing make system and integrating the correct steps into that already existent environment. What we have done is spent time studying how the ESP-IDF works and reverse engineered enough of it to build this recipe. First, if we run the ESP-IDF make system with the environment variable `VERBOSE` set to `1`, we get a lot of detail. Here is what I currently see from a current build:

```
xtensa-esp32-elf-gcc -DESP_PLATFORM -Og -g3 -Wpointer-arith -Werror -Wno-error=unused-  
function -Wno-error=unused-but-set-variable -Wno-error=unused-variable -Wall  
-ffunction-sections -fdata-sections -mlongcalls -nostdlib -MMD -MP -std=gnu99 -g3  
-fstrict-volatile-bitfields -DMBEDTLS_CONFIG_FILE='"mbedtls/esp_config.h"'  
-DHAVE_CONFIG_H  
-I /home/pi/projects/esp32/apps/parallell/main/include  
-I /home/pi/projects/esp32/esp-idf/components/bt/include
```

```

-I /home/pi/projects/esp32/esp-idf/components/driver/include
-I /home/pi/projects/esp32/esp-idf/components/esp32/include
-I /home/pi/projects/esp32/esp-idf/components/expat/port/include
-I /home/pi/projects/esp32/esp-idf/components/expat/include/expat
-I /home/pi/projects/esp32/esp-idf/components/freertos/include
-I /home/pi/projects/esp32/esp-idf/components/json/include
-I /home/pi/projects/esp32/esp-idf/components/json/port/include
-I /home/pi/projects/esp32/esp-idf/components/log/include
-I /home/pi/projects/esp32/esp-idf/components/lwip/include/lwip
-I /home/pi/projects/esp32/esp-idf/components/lwip/include/lwip/port
-I /home/pi/projects/esp32/esp-idf/components/lwip/include/lwip/posix
-I /home/pi/projects/esp32/esp-idf/components/mbdts/port/include
-I /home/pi/projects/esp32/esp-idf/components/mbdts/include
-I /home/pi/projects/esp32/esp-idf/components/newlib/include
-I /home/pi/projects/esp32/esp-idf/components/nghttp/port/include
-I /home/pi/projects/esp32/esp-idf/components/nghttp/include
-I /home/pi/projects/esp32/esp-idf/components/nvs_flash/include
-I /home/pi/projects/esp32/esp-idf/components/spi_flash/include
-I /home/pi/projects/esp32/esp-idf/components/tcpip_adapter/include
-I /home/pi/projects/esp32/apps/parallell/build/include/
-I. -c /home/pi/projects/esp32/apps/parallell/main/./main.c -o main.o

```

Let us now pull it apart piece by piece and see what it going on:

- `xtensa-esp-elf-gcc` – This is the C compiler that generates compiled code for the ESP32 CPUs.
- `-DESP_PLATFORM` – This sets the existence of a macro definition called "ESP\_PLATFORM". The belief is that this can be used by the C pre-processor to include, exclude or otherwise manipulate the source before compilation. For example, there may be source files that have common code within them where some code is valid for one environment/platform and some other code, also contained in the same source file, is valid for a different environment/platform. The existence of `ESP_PLATFORM` could be used as a distinguisher within the code.
- `-Og` – Optimize for debugging experience.
- `-g3` – Level 3 debugging information included.
- `-Wpointer-arith` – Produce warnings relating to pointer arithmetic. Specifically, anything that relies on the size of a function type or the size of void.
- `-Werror` – Make all warnings into errors. This stops/fails a compilation on any warnings produced during compile.
- `-Wno-error=unused-function` – Don't flag an un-used function as an error.
- `-Wno-error=unused-but-set-variable` – Don't flag an unused variable as an error that had a value set upon it.
- `-Wno-error=unused-variable` – Don't flag an unused variable as an error.

- `-Wall` – Enable a large set of warnings.
- `-ffunction-sections` – Place each function in its own section.
- `-fdata-sections` – Place each piece of data in its own section.
- `-mlongcalls` – An Xtensa specific option
- `-nostdlib` – Do not use the standard startup files or libraries when linking.
- **-MMD**
- `-MP` – Something about makefiles.
- `-std=gnu99` – Set the compiler standard.
- `-fstrict-volatile-bitfields` – How volatile bit fields should be accessed.
- `-DMBEDTLS_CONFIG_FILE=""mbedtls/esp_config.h""`
- `-DHAVE_CONFIG_H` – Define a macro flag.
- `-I <various>` – Specify directories which should be searched for includes. The majority of additional directories are included in the ESP-IDF directory structures.
- `-c` – Compile to object file with no linking.
- `-o <filename>` – write the output into the given file.

If we need to include additional code that is only present on an ESP32, we can use the existence of the macro definition `"ESP_PLATFORM"` as the indicator. For example:

```
#ifdef ESP_PLATFORM
// ESP32 specific code
#endif
```

## Flashing

Flashing is the mechanism used to move a binary from the file system into the ESP32. If we are using the ESP-IDF, then the process is very straightforward. We can use the command `"make flash"` and the tools needed to flash the ESP32 will be run for us with the correct inputs. The primary parameters for a flash are the port used to communicate with the ESP32 and the baud rate (transmission rate) to be used. These and other settings can be configured in the `"make menuconfig"` in the sub menu called `"Serial flasher config"`:

```
(/dev/ttyUSB0) Default serial port
Default baud rate (921600 baud) --->
[*] Use compressed upload
Flash SPI mode (DIO) --->
Flash SPI speed (40 MHz) ---->
Flash size (4 MB) --->
```

We can over-ride these at the command line by using:

```
$ make flash ESPPORT=<serial port> ESPBAUD=<baud rate>
```

The environment variable `ESPSPORT` specifies the serial port and `ESPBAUD` specifies the baud rate. If not supplied, the values defined in `make menuconfig` will be used.

By examination of the recipes supplied by Espressif, we find that the underlying command is as follows

```
python /home/pi/projects/esp32/esp-idf/components/esptool_py/esptool/esptool.py --chip
esp32 --port "/dev/ttyUSB0" --baud 230400 write_flash -z --flash_mode "dio"
--flash_freq "40m"
0x1000 /home/pi/projects/esp32/apps/parallell/build/bootloader/bootloader.bin
0x10000 /home/pi/projects/esp32/apps/parallell/build/app-template.bin
0x4000 /home/pi/projects/esp32/apps/parallell/build/partitions_singleapp.bin
```

Breaking this down we arrive at:

- `python` – run a python script.
- `esptool.py` – Run the program called "esptool.py".
- `--chip esp32` – Declare that we are flashing an ESP32.
- `--port "/dev/ttyUSB0"` – Define the serial port to which the ESP32 is connected.
- `--baud 115200` – Define the transmission baud rate across the serial port.
- `write_flash` – Perform the write flash command.
- `-z` – Unknown.
- `--flash_mode "dio"` – Use "dio" flash mode.
- `--flash_freq "40m"` – Use a flash frequency of "40m"
- `0x1000 bootloader.bin` – Load the bootloader at 0x1000.
- `0x10000 appname.bin` – Load the application at 0x10000.
- `0x4000 partitions_singleapp.bin` – Load the partition table at 0x4000.

Following the construction of the ELF file, we now run a tool which converts the ELF into an uploadable image. Again, looking at the ESP-IDF tools, we find the following command being run:

```
python /home/pi/projects/esp32/esp-idf/components/esptool_py/esptool/esptool.py --chip
esp32 elf2image --flash_mode "dio" --flash_freq "40m" -o
/home/pi/projects/esp32/apps/v1/build/app-template.bin
/home/pi/projects/esp32/apps/v1/build/app-template.elf
```

- python
- esptool.py
- --chip esp32
- elf2image
- --flash\_mode "dio"
- --flash\_freq "40m"
- -o <output file>
- <input elf file>

### Loading a program

Once the program has been compiled, it needs to be loaded into the ESP32. This task is called "flashing". In order to flash the ESP32, it needs to be placed in a mode where it will accept the new incoming program to replace the old existing program. The way this is done is to reboot the ESP32 either by removing and reapplying power or by bringing the REST pin low and then high again. However, just rebooting the device is not enough. During start-up, the device examines the signal value found on `GPIO0`. If the signal is low, then this is the indication that a flash programming session is about to happen. If the signal on `GPIO0` is high, it will enter its normal operation mode. Because of this, it is recommended not to let `GPIO0` float. We don't want it to accidentally enter flashing mode when not desired. A pull-up resistor of 10k is perfect.

We can build a circuit which includes a couple of buttons. One for performing a reset and one for bringing `GPIO0` low. Pressing the reset button by itself will reboot the device. This alone is already useful. However if we are holding the "GPIO0 low" button while we press reset, then we are placed in flash mode.

This however suffers from the disadvantage that it requires us to manually press some buttons to load a new application. This is not a horrible situation but maybe we have alternatives?

When we are flashing our ESP32s, we commonly connect them to USB->UART converters. These devices are able to supply UART used to program the ESP32. We are familiar with the pins labeled RX and TX but what about the pins labeled RTS and DTR ... what might those do for us?

RTS which is "Request to Send" is an output from the UART to inform the downstream device that it may now send data. This is commonly connected to the partner input CTS which is "Clear to Send" which indicates that it is now acceptable to send data. Both RTS and CTS are active low.

DTR which is "Data Terminal Ready" is used in flow control.

When flashing the device using the Eclipse tools and recipes the following are the flash commands that are run (as an example) and the messages logged:

```
22:34:17 **** Build of configuration Default for project k_blinky ****
mingw32-make.exe -f C:/Users/User1/Workspace/k_blinky/Makefile flash
c:/Espressif/utils/esptool.exe -p COM11 -b 115200 write_flash -ff 40m -fm qio -fs 4m
0x000000 firmware/eagle.flash.bin 0x400000 firmware/eagle.irom0text.bin
Connecting...
Erasing flash...
head: 8 ;total: 8
erase size : 16384

Writing at 0x00000000... (3 %)
Writing at 0x00000400... (6 %)
...
Writing at 0x00007000... (96 %)
Writing at 0x00007400... (100 %)
Written 30720 bytes in 3.01 seconds (81.62 kbit/s)...
Erasing flash...
head: 16 ;total: 41
erase size : 102400

Writing at 0x00040000... (0 %)
Writing at 0x00040400... (1 %)
...
Writing at 0x00067c00... (99 %)
Writing at 0x00068000... (100 %)
Written 164864 bytes in 16.18 seconds (81.53 kbit/s)...

Leaving...

22:34:40 Build Finished (took 23s.424ms)
```

As an example of what the messages look like if we **fail** to put the ESP32 into flash mode, we have the following:

```
13:47:09 **** Build of configuration Default for project k_blinky ****
mingw32-make.exe -f C:/Users/User1/Workspace/k_blinky/Makefile flash
c:/Espressif/utils/esptool.exe -p COM11 -b 115200 write_flash -ff 40m -fm qio -fs 4m
```



```
0x00000 firmware/eagle.flash.bin 0x40000 firmware/eagle.irom0text.bin
Connecting...
Traceback (most recent call last):
  File "esptool.py", line 558, in <module>
  File "esptool.py", line 160, in connect
Exception: Failed to connect
C:/Users/User1/WorkSpace/k_blinky/Makefile:313: recipe for target 'flash' failed
mingw32-make.exe: *** [flash] Error 255

13:47:14 Build Finished (took 5s.329ms)
```

The tool called `esptool.py` provides an excellent environment for flashing the device but it can also be used for "reading" what is currently stored upon it. This can be used for making backups of the applications contained within before re-flashing them with a new program. This way, you can always return to what you had before over-writing. For example, on Unix:

```
esptool.py --port /dev/ttyUSB0 read_flash 0x00000 0xFFFF backup-0x00000.bin
esptool.py --port /dev/ttyUSB0 read_flash 0x10000 0x3FFFF backup-0x10000.bin
```

See also:

- [USB to UART converters](#)
- [What is a UART?](#)
- `esptool`
- [Error: Reference source not foundThe Bootloader](#)

## Programming environments

We can program the ESP32 using the Espressif supplied SDK on Windows using Eclipse. A separate chapter on setting up that environment is supplied. We also have the ability to program the ESP32 using the Arduino IDE. This is potentially a game changing story and it too been given its own important chapter.

See also:

- [Programming using Eclipse](#)
- [Programming using the Arduino IDE](#)

## Compilation tools

There are a number of tools that are essential when building C based ESP32 applications. Many of these tools are supplied as part of the Xtensa tool chain. Let us

remind ourselves that an executable that runs on the ESP32 executes machine code in Xtensa instruction set. This means that we need a compiler that generates Xtensa code as opposed to a compiler that generates Intel x86 code.

When a compiler runs on one architecture and generates codes for a different architecture, that is called a cross compiler. For example, if we have a C source application and compile it with the Xtensa compiler on an Intel platform, we generate Xtensa executable code that is not executable on the Intel platform on which it was compiled. My convention is to install the Xtensa tool set at:

```
/opt/xtensa-esp32-elf
```

with the binaries themselves being in

```
/opt/xtensa-esp32-elf/bin
```

If we list the tools contained within we will find that they are all prefixed with "xtensa-esp32-elf-". The reason for the long name is that we want to be very clear that we are using a cross compiler tool as opposed to a tool with the exact same name (without the prefix) that may already be present on the platform where we are performing the compilation. For example, on a Linux platform, it is not uncommon to compile a C program using the compiler called "gcc". If one typed "gcc main.c", it is likely it will compile and produce an object file. However, the code produced would be the native code for the compilation platform ... likely to be Intel x86. The same program to compile for ESP32 would then be "xtensa-esp32-elf-gcc main.c".

### xtensa-esp32-elf-ar

The archive tool is used to packaged together compiled object files into libraries. These libraries end with ".a" (archive). A library can be named when using a linker and the objects contained within will be used to resolve externals.

Some of the most common flags used with this tool include:

- -c – Create a library
- -r – Replace existing members in the library
- -u – Update existing members in the library

The syntax of the command is:

```
ar -cru libraryName member.o member.o ...
```

See also:

- [GNU – ar](#)
- [xtensa-esp32-elf-nm](#)

## esptool

This tool is an open source implementation used to flash the ESP32 through a serial port. It is written in Python. Versions have been seen to be available as windows executables that appear to have been generated ".EXE" files from the Python code suitable for running on Windows without a supporting Python run-time installation. The location of the tool is:

```
$IDF_PATH/components/esptool_py/esptool/esptool.py
```

The flags are:

- `-p port | --port port` – The serial port to use
- `-b baud | --baud baud` – The baud rate to use for serial. Common baud rates include:
  - 115200 – basic speed
  - 921600 – high speed
- `-h` – Help
- `{command} -h` – Help for that command
- `load_ram {filename}` – Upload an image to RAM and execute
- `dump_mem {address} {size} {filename}` – Dump arbitrary memory to disk
- `read_mem {address}` – Read arbitrary memory location
- `write_mem {address} {value} {mask}` – Read-modify-write to arbitrary memory location
- `write_flash` – Write a binary blob to flash
  - `--flash_freq {40m,26m,20m,80m} | -ff {40m,26m,20m,80m}` – SPI Flash frequency
  - `--flash_mode {qio,qout,dio,dout} | -fm {qio,qout,dio,dout}` – SPI Flash mode
  - `--flash_size {4m,2m,8m,16m,32m,16m-c1,32m-c1,32m-c2} | -fs {4m,2m,8m,16m,32m,16m-c1,32m-c1,32m-c2}` – SPI Flash size in Mbit
  - `-z` or `--compress` – compress during transmission
  - `{address} {fileName}` – Address to write, file to write ... repeatable
- `read_flash` – Read a blob of flash
  - `{address} {size} {fileName}`

- `run` – Run application code in flash
- `image_info {image file}` – Dump headers from an application image. Here is an example output:

```
Entry point: 40100004
3 segments

Segment 1: 25356 bytes at 40100000
Segment 2: 1344 bytes at 3ffe8000
Segment 3: 924 bytes at 3ffe8540
```

```
Checksum: 40 (valid)
```

Here is an example of `image_info` against the `bootloader.bin`:

```
esptool.py v2.0-dev
Image version: 1
Entry point: 40098200
4 segments

Segment 1: len 0x00000 load 0x3ffc0000 file_offs 0x00000018
Segment 2: len 0x00a08 load 0x3ffc0000 file_offs 0x00000020
Segment 3: len 0x01068 load 0x40078000 file_offs 0x00000a30
Segment 4: len 0x00378 load 0x40098000 file_offs 0x00001aa0
Checksum: 92 (valid)
```

- `make_image` – Create an application image from binary files
  - `--segfile SEGFILE, -f SEGFILE` – Segment input file
  - `--segaddr SEGADDR, -a SEGADDR` – Segment base address
  - `--entrypoint ENTRYPOINT, -e ENTRYPOINT` – Address of entry point
  - `output`
- `elf2image` – Create an application image from ELF file. The system image is a data file format that is used/parsed by the bootloader in order to map the data. See also: The Bootloader
  - `--chip esp32`
  - `--output OUTPUT, -o OUTPUT` – Output filename prefix
  - `--flash_freq {40m,26m,20m,80m}, -ff {40m,26m,20m,80m}` – SPI Flash frequency
  - `--flash_mode {qio,qout,dio,dout}, -fm {qio,qout,dio,dout}` – SPI Flash mode
  - `--flash_size {4m,2m,8m,16m,32m,16m-c1,32m-c1,32m-c2}, -fs {4m,2m,8m,16m,32m,16m-c1,32m-c1,32m-c2}` – SPI Flash size in Mbit

- `--entry-symbol ENTRY_SYMBOL, -es ENTRY_SYMBOL` - Entry point symbol name (default 'call\_user\_start')

- `read_mac` – Read MAC address from OTP ROM. Here is an example output:

```
MAC AP: 1A-FE-34-F9-43-22
MAC STA: 18-FE-34-F9-43-22
```

- `chip_id` – Read chip ID.
- `flash_id` – Read SPI flash manufacturer and device ID. Here is an example output:

```
head: 0 ;total: 0
erase size : 0
Manufacturer: c8
Device: 4014
```

- `read_flash_status`
- `write_flash_status`
- `read_flash` – Read SPI flash content
  - `address` – Start address
  - `size` – Size of region to dump
  - `filename` – Name of binary dump
- `verify_flash`
- `erase_flash` – Perform Chip Erase on SPI flash. This is an especially useful command if one ends up someone bricking the device as it should reset the device to its defaults.
- `erase_region`
- `version`

See also:

- Loading a program
- [Github: espressif/esptool](#)

### xtensa-esp32-elf-gcc

The open source GNU Compiler Collection includes compilers for C and C++. If we look carefully at the flags that are supplied for compiling and linking code for the ESP32 we find the following:

### Compiling

- `-c` – Compile the code to a `.o` object file.
- `-Os` – Optimize code generation for size.
- `-O2` – Optimize for performance which code result in larger code size. For example, instead of making a function call, code could be in-lined.
- `-ggdb` – Generate debug code that can be used by the `gdb` debugger..
- `-std=gnu90` – Dialect of C supported.
- `-Werror` – Make all warnings errors.
- `-Wno-address` – Do not warn about suspicious use of memory addresses.
- `-Wpointer-arith` – Warn when pointer arithmetic is attempted that depends on `sizeof`.
- `-Wundef` – Warn when an identifier is found in a `#if` directive that is not a macro.
- `-fno-inline-functions` – Do not allow functions to be replaced with in-line code.
- `-mlongcalls` – Translate direct assembly language calls into indirect calls.
- `-mtext-section-literals` – Allow literals to be intermixed with the text section.
- `-mno-serialize-volatile` – Special instructions for volatile definitions.

#### Linking:

- `-nostdlib` – Don't use standard C or C++ system startup libraries

#### See also:

- [GCC – The GNU Compiler Collection](#)

#### gen\_appbin.py

The syntax of this tool is:

```
gen_appbin.py app.out boot_mode flash_mode flash_clk_div flash_size
```

- `flash_mode`
  - 0 – QIO
  - 1 – QOUT
  - 2 – DIO
  - 3 – DOUT
- `flash_clk_div`

- 0 – 80m / 2
- 1 – 80m / 3
- 2 – 80m / 4
- 0xf – 80m / 1
- flash\_size\_map
  - 0 – 512 KB (256 KB + 256 KB)
  - 1 – 256 KB
  - 2 – 1024 KB (512 KB + 512 KB)
  - 3 – 2048 KB (512 KB + 512 KB)
  - 4 – 4096 KB (512 KB + 512 KB)
  - 5 – 2048 KB (1024 KB + 1024 KB)
  - 6 – 4096 KB (1024 KB + 1024 KB)

The following files are expected to exist:

- eagle.app.v6.irom0text.bin
- eagle.app.v6.text.bin
- eagle.app.v6.data.bin
- eagle.app.v6.rodata.bin

The output of this command is a new file called `eagle.app.flash.bin`.

### make

Make is a compilation engine used to track what has to be compiled in order to build your target application. Make is driven by a Makefile. Although powerful and simple enough for simple C projects, it can get complex pretty quickly. If you find yourself studying Makefiles written by others, grab the excellent GNU make documentation and study it deeply.

### xtensa-esp32-elf-strip

See also:

- [man\(8\) - strip](#)

### xtensa-esp32-elf-nm

List symbols from object files.

Useful flags:

- `--defined-only` – Show only defined exports
- `--undefined-only` – Show only undefined exports
- `--line-numbers`

See also:

- `xtensa-esp32-elf-ar`
- GNU – [nm](#)

### xtensa-esp32-elf-objcopy

See also:

- GNU – [objcopy](#)

### xtensa-esp32-elf-objdump

Some of the more important flags are:

- `--syms` – Dump the symbols in the archive.
- `--headers` – Dump the section headers.

See also:

- Wikipedia – [objdump](#)
- GNU – [objdump](#)
- man page – [objdump\(1\)](#)

### xxd

This is a deceptively simple but useful tool. What it does is dump binary data contained within a file in a formatted form. One powerful use of it is to take a binary file and produce a C language data structure that represents the content of the file. This means that you can take binary data and include it in your applications.

The following will read the content of `inFile` as binary data and produce a header file in the `outFile`.

```
xxd -include <inFile> <outFile>
```



## Linking

We have seen how to compile a C source file into its object file (.o) representation. Now we turn our attention on how to link these object files together with the ESP32 libraries in order to produce a binary file that can be flashed into the ESP32 for execution.

If we examine the output of compiling a project using the ESP-IDF with the `VERBOSE=1` flag set, we see the underlying command used to perform the linking. Here is an example and then we'll start to pull it apart:

```
xtensa-esp32-elf-gcc -nostdlib -L/home/pi/projects/esp32/esp-idf/lib
-L/home/pi/projects/esp32/esp-idf/ld
-L/home/pi/projects/esp32/apps/parallel1/build/bootloader
-L/home/pi/projects/esp32/apps/parallel1/build/bt
-L/home/pi/projects/esp32/apps/parallel1/build/driver
-L/home/pi/projects/esp32/apps/parallel1/build/esp32
-L/home/pi/projects/esp32/apps/parallel1/build/esptool_py
-L/home/pi/projects/esp32/apps/parallel1/build/expat
-L/home/pi/projects/esp32/apps/parallel1/build/freertos
-L/home/pi/projects/esp32/apps/parallel1/build/json
-L/home/pi/projects/esp32/apps/parallel1/build/log
-L/home/pi/projects/esp32/apps/parallel1/build/lwip
-L/home/pi/projects/esp32/apps/parallel1/build/mbdtdls
-L/home/pi/projects/esp32/apps/parallel1/build/newlib
-L/home/pi/projects/esp32/apps/parallel1/build/nghttp
-L/home/pi/projects/esp32/apps/parallel1/build/nvs_flash
-L/home/pi/projects/esp32/apps/parallel1/build/partition_table
-L/home/pi/projects/esp32/apps/parallel1/build/spi_flash
-L/home/pi/projects/esp32/apps/parallel1/build/tcpip_adapter
-L/home/pi/projects/esp32/apps/parallel1/build/main -u call_user_start_cpu0 -Wl,--gc-
sections -Wl,-static -Wl,--start-group -lbt -L/home/pi/projects/esp32/esp-
idf/components/bt/lib -lbtadm_app -ldriver -lesp32 /home/pi/projects/esp32/esp-
idf/components/esp32/libhal.a -L/home/pi/projects/esp32/esp-idf/components/esp32/lib
-lcrypto -lcore -lnet80211 -lphy -lrtc -lpp -lwpa -L /home/pi/projects/esp32/esp-
idf/components/esp32/ld -T esp32_out.ld -T esp32.common.ld -T esp32.rom.ld -T
esp32.peripherals.ld -lexpat -lfreertos -Wl,--undefined=uxTopUsedPriority -ljson
-llog -llwip -lmbdtdls /home/pi/projects/esp32/esp-
idf/components/newlib/lib/libc.a /home/pi/projects/esp32/esp-
idf/components/newlib/lib/libm.a -lnghttp -lnvs_flash -lspi_flash
-ltcpip_adapter -lmain -lgcc -Wl,--end-group -Wl,-EL -o
/home/pi/projects/esp32/apps/parallel1/build/app-template.elf -Wl,-
Map=/home/pi/projects/esp32/apps/parallel1/build/app-template.map
```

- `xtensa-esp32-elf-gcc` – The compiler for the Xtensa architecture which also knows how to link.
- `-nostdlib` – Do not link with the standard startup files and libraries.
- `-L <various>` – Specify the directories which should be searched for library files.

- `-u call_user_start_cpu0` – Pretend that the symbol called "call\_user\_start\_cpu0" is undefined to force the linker to resolve it.
- `-Wl,--gc-sections` – Garbage collect unused input sections.
- `-Wl,-static` – Do not link against shared libraries.
- `-Wl,--start-group` – Start a group of archives. Used to resolve circular references.
- `-Wl,-EL` – Link in little-endian format.
- `<various libraries>` – Link with the named libraries.
- `-Wl,--end-group` – End a group of archives.
- `-T esp32_out.ld` – Use a Linker script. Found in `build/esp32.ld`.
- `-T esp32.common.ld` – Use a Linker script. Found in `ESP_IDF/components/esp32/ld/esp32.common.ld`.
- `-T esp32.rom.ld` – Use a Linker script. Found in `ESP_IDF/components/esp32/ld/esp32.rom.ld`.
- `-T esp32.peripherals.ld` – Use a Linker script. Found in `ESP_IDF/components/esp32/ld/esp32.peripherals.ld`.
- `-o <filename>` – Write the result to the named file.
- `-Wl,-Map=<filename>` – Write a link map to the named file.

#### Linked libraries:

- `-lbt` – `build/bt/libbt.a`
- `-lbt_dm_app` – `ESP_IDF/components/bt/lib/libbt_dm_app.a`
- `-ldriver` – `build/driver/libdriver.a`
- `-lesp32` – `build/esp32/libesp32.a`
- `libhal.a` – `ESP_IDF/components/esp32/libhal.a`
- `-lcrypto` – `ESP_IDF/components/esp32/lib/libcrypto.a`
- `-lcore` – `ESP_IDF/components/esp32/lib/libcore.a`
- `-lnet80211` – `ESP_IDF/components/esp32/lib/libnet80211.a`
- `-lphy` – `ESP_IDF/components/esp32/lib/libphy.a`
- `-lrtc` – `ESP_IDF/components/esp32/lib/librtc.a`

- `-lpp` – `ESP_IDF/components/esp32/lib/libpp.a`
- `-lwpa` – `ESP_IDF/components/esp32/lib/libwpa.a`
- `-lexpat` – `build/expat/libexpat.a`
- `-lfreertos` – `build/freertos/libfreertos.a`
- `-ljson` – `build/json/libjson.a`
- `-llog` – `build/log/liblog.a`
- `-llwip` – `build/lwip/liblwip.a`
- `-lmbdtdls` – `build/mbdtdls/libmbdtdls.a`
- `libc.a` – `ESP_IDF/components/newlib/lib/libc.a`
- `libm.a` – `ESP_IDF/components/newlib/lib/libm.a`
- `-lnghttp` – `build/nghttp/libnghttp.a`
- `-lnvs_flash` – `build/nvs_flash/libnvs_flash.a`
- `-lspi_flash` – `build/spi_flash/libspi_flash.a`
- `-ltcpip_adapter` – `build//tcpip_adapter/libtcpip_adapter.a`
- `-lmain` – Project files
- `-lgcc`

Within a linked executable there are a variety of "sections". We can dump those with

```
$ xtensa-esp32-elf-objdump --headers <file.elf>
```

Here is an example (note some of the more uninteresting entries were removed)

```
app-template.elf:      file format elf32-xtensa-le
```

Sections:

Idx	Name	Size	VMA	LMA	File off	Algn
0	.iram0.vectors	00000400	40080000	40080000	00006b40	2**2
			CONTENTS, ALLOC, LOAD, READONLY, CODE			
1	.iram0.text	000167d2	40080400	40080400	00006f40	2**2
			CONTENTS, ALLOC, LOAD, READONLY, CODE			
2	.dram0.bss	0000f310	3ffb0000	3ffb0000	00005878	2**3
			ALLOC			
3	.dram0.data	000012c0	3ffbf310	3ffbf310	00005880	2**4
			CONTENTS, ALLOC, LOAD, DATA			
4	.flash.rodata	00005794	3f400010	3f400010	000000e0	2**4
			CONTENTS, ALLOC, LOAD, DATA			
5	.flash.text	00028ded	400d0018	400d0018	0001d714	2**2
			CONTENTS, ALLOC, LOAD, READONLY, CODE			
16	.comment	00000062	00000000	00000000	0020f49b	2**0

```

CONTENTS, READONLY
17 .xtensa.info 00000038 00000000 00000000 0020f4fd 2**0
CONTENTS, READONLY

```

From the above, here are some of the interesting parts:

Section	Load address	size
.iram0.vectors	0x4008 0000	1024 (0x400)
.iram0.text	0x4008 0400	91114 (0x167d2)
.dram0.bss	0x3ffb 0000	62224 (0xf310)
.dram0.data	0x3ffb f310	4800 (0x12c0)
.flash.rodata	0x3f40 0010	22420 (0x5794)
.flash.text	0x400d 0018	167405 (0x28ded)

After we have linked our libraries together to form an application that is ready for flashing to the ESP32, we can ask the question: "What does the binary actually contain?". There are a set of make tools available that will produce diagnostic logs of the executable that will tell us this information. These commands are:

- `make size` – Show application wide information.
- `make size-components` – Show component information of components used by the application.
- `make size-files` – Show files (object files) information from each component used by the application.

### Sizes of images

When you have compiled and link-edited your files together and have produced an image for flashing to the ESP32 for execution, you may be wondering how the space is used. There are a series of make commands that can be used to show the content of the generated image files. These commands are:

- `make size`
- `make size-components`
- `make size-files`

These commands produce finer and finer grained results. Her for example is the output of a typical `make size`:

```

Total sizes:
  DRAM .data size:      8224 bytes
  DRAM .bss size:      37000 bytes
Used static DRAM:    45224 bytes ( 216920 available, 17.3% used)
Used static IRAM:    68504 bytes ( 62568 available, 52.3% used)
  Flash code:    587295 bytes

```

Flash rodata: 214580 bytes  
Total image size:~ 878603 bytes (.bin may be padded larger)

while here is an output of `make size-components`:

Archive File	DRAM	.data & .bss	IRAM	Flash code	& rodata	Total
libbt.a	517	23129	511	291933	145940	462030
libbtdm_app.a	247	4634	9214	21891	2358	38344
libc.a	0	0	0	92641	5295	97936
libcoexist.a	32	14	277	17	78	418
libcore.a	0	0	0	0	0	0
libcpp_utils.a	5	1968	0	42576	31554	76103
libcxx.a	8	16	0	545	546	1115
libdriver.a	24	8	0	442	2309	2783
libesp32.a	1989	217	4830	6708	5559	19303
libethernet.a	0	0	0	0	0	0
libfreertos.a	2092	728	11112	0	1062	14994
libgcc.a	0	20	104	9152	568	9844
libhal.a	0	0	515	0	32	547
libheap.a	1559	4	2862	1118	1048	6591
liblog.a	8	268	420	82	0	778
liblwip.a	0	0	0	0	0	0
libm.a	0	0	104	0	0	104
libmain.a	0	114	0	1588	958	2660
libnet80211.a	0	0	0	0	0	0
libnewlib.a	152	252	756	463	98	1721
libnvs_flash.a	0	32	0	9026	5776	14834
libphy.a	1330	856	26413	0	0	28599
libpp.a	0	0	0	0	0	0
libpthread.a	0	28	0	70	0	98
librtc.a	0	4	2021	0	0	2025
libsoc.a	0	0	3152	0	1852	5004
libspi_flash.a	32	317	5192	587	526	6654
libstdc++.a	132	4268	0	101596	8262	114258
libtcpip_adapter.a	0	0	0	0	0	0
libvfs.a	40	63	0	2109	465	2677
libwpa.a	0	0	0	0	0	0
libwpa2.a	0	0	0	0	0	0
libwpa_supplicant.a	0	0	0	0	0	0

## Debugging

When writing programs, we may find that they don't always run as expected. Performing debugging on an SOC can be difficult since we have no readily available source level debuggers.

## ESP-IDF logging

The ESP-IDF framework provides a simple framework for message and diagnostic logging. Use these as opposed to simple "`printf()`" statements. These logging

statements can then be inserted in your own application for diagnosing problems or capturing traces. The messages can be conditionally enabled or disabled at runtime.

To use the logging functions, we must include "esp\_log.h" and also include the generated "sdkconfig.h".

The high level logging function is called "esp\_log\_write()" which has the following signature:

```
void esp_log_write(esp_log_level_t level, const char *tag, const char * format, ...)
```

Think of it like a specialized `printf` logger. The format and following parameters follow the `printf` style convention.

By default, when logging is requested, the output is sent to the primary serial stream. However, we can over-ride that destination by using the function called `esp_log_set_vprintf()`. This takes as a parameter a reference to a C function that has the same syntax as `vprintf`. Specifically:

```
int myPrintFunction(const char *format, va_list arg)
```

When we wish to log a message, we choose a log level to write to. The log levels available are:

- `ESP_LOG_NONE`
- `ESP_LOG_ERROR`
- `ESP_LOG_WARN`
- `ESP_LOG_INFO`
- `ESP_LOG_DEBUG`
- `ESP_LOG_VERBOSE`

The logged output is of the format:

```
<log level> (<time stamp>) <tag>: <message>
```

Where log level is one of "E", "W", "I", "D" or "V". The time stamp is the number of milliseconds since boot.

We also have a global setting which is the maximum log level we should log. For example if we set `ESP_LOG_WARN` then messages at level `ESP_LOG_WARN`, `ESP_LOG_ERROR` will be logged but `ESP_LOG_INFO`, `ESP_LOG_DEBUG` and `ESP_LOG_VERBOSE` will be excluded.

The tag parameter to the logging function provides an indication of which logical component/module issues the message. This provides context to what otherwise might be ambiguous messages.

C language macros are provided to make using the logging simpler. The macros are:

- `ESP_LOGE(tag, format, ...)` - Log an error.
- `ESP_LOGW(tag, format, ...)` - Log a warning.
- `ESP_LOGI(tag, format, ...)` - Log information.
- `ESP_LOGD(tag, format, ...)` - Log debug.
- `ESP_LOGV(tag, format, ...)` - Log verbose information.

Since logging is included or excluded at compile time, we can specify the logging level to include in our builds. At compile time, this may exclude certain log statements from the source. The compilation flag `-DLOG_LOCAL_LEVEL` controls the logging levels included.

For the log statements that remain in the code after compilation that were not excluded at build time, we can control the log level at run-time by calling `esp_log_level_set()`. The signature of this function is:

```
void esp_log_level_set(const char *tag, esp_log_level_t level)
```

The tag names the logging groups that we will show. If the special tag of name "\*" is supplied, this matches all tags.

If we are writing interrupt handling routines, do not use these logging functions within those.

Should we wish to dump areas of storage, there are a couple of useful macros. First we have the macros called `ESP_LOG_BUFFER_HEXDUMP` and `ESP_LOG_BUFFER_CHAR_LEVEL`.

- `ESP_LOG_BUFFER_HEXDUMP(tag, buffer, bufferLen, level)`
- `ESP_LOG_BUFFER_CHAR_LEVEL(tag, buffer, bufferLen, level)`

There are a couple of global configuration settings relating to log output that can be set within the "menuconfig". These are:

- Default log verbosity – choice – `CONFIG_LOG_DEFAULT_LEVEL`
- Use ANSI terminal colors in log output – boolean – `CONFIG_LOG_COLORS`

When working with gcc compiler, remember that you have a couple of useful pre-defined variables at your disposal when logging. These are:

- `__func__` – The name of the current function

- `__PRETTY_FUNCTION__` – The name of the current function with signature.

At boot there is also some set of messages logged. These can be disabled by holding GPIO15 low for the boot period.

See also:

- Error handling
- `esp_log_level_set`
- `esp_log_set_vprintf`
- `esp_log_write`

## Exception handling

At run-time, things may not always work as expected and an exception can be thrown. For example, you might attempt to access storage at an invalid location or write to read only memory or perform a divide by zero.

When an exception is detected on an ESP32, a register dump is performed on the primary serial output. For example the text may look like:

```
Guru Meditation Error of type LoadProhibited occurred on core 0. Exception was un-
handled.
Register dump:
PC      : 400f835d  PS      : 00060a30  A0      : 800f83e9  A1      : 3ffc45a0
A2      : 3f4084bc  A3      : 3ffc4738  A4      : 00000001  A5      : 00000000
A6      : 3ffb013c  A7      : 00000001  A8      : df405982  A9      : 3ffc4550
A10     : ffffffff  A11     : 3ffc4738  A12     : 000000ba  A13     : 0000002b
A14     : 0000001b  A15     : 00000001  SAR     : 00000020  EXCCAUSE: 0000001c
EXCVADDR: df405986  LBEG    : 4000c28c  LEND    : 4000c296  LCOUNT : 00000000
Rebooting...
```

If we know the location of the exception, we can analyze the executable (`app.out`) to figure out what piece of code caused the problem.

```
xtensa-esp32-elf-objdump -x app-template.elf -d
```

Another option is to load the binary with GDB as in:

```
xtensa-esp32-elf-gdb ./build/app-template.elf
```

From there we can run:

```
info symbol 0x<address>
```

This will return an indication of where within the code an error was detected. Here is an example:

```
(gdb) info symbol 0x400f8806
initSockets + 114 in section .flash.text
```

This showed that an exception occurred within my "`initSockets`" function (which was indeed the case).

If we then run:



```
list *0x<address>
```

it will show us the source line number and lines. Here is another example:

```
(gdb) list *0x400f8806
0x400f8806 is in initSockets
(/home/pi/projects/esp32/apps/myapp/main/./app_main.c:54).
49
50     struct sockaddr_in clientAddress;
51     socklen_t clientAddressLength = sizeof(clientAddress);
52     int clientSock = accept(sock, (struct sockaddr *)&clientAddress,
&clientAddressLength);
53     checkSocketRC(clientSock, "accept");
54     printf("Accepted a client connection\n");
55 }
56
57 static void dumpState() {
58     esp_err_t err;
```

### Address to source line

Imagine you are working of a project and find that the code at `0x40086c46` is throwing an error. This is great but how do you relate that back to your source statements within your own source code? Thankfully there is an answer provided through the tool called "addr2line".

For example:

```
$ xtensa-esp32-elf-addr2line -e build/myapp.elf 40086c46
/home/kolban/esp32/esptest/esp-idf/components/freertos/./tasks.c:4510
```

This tells us the source file and line number.

Adding "-f" shows us the function name:

```
xTaskCreatePinnedToCore
/home/kolban/esp32/esptest/esp-idf/components/freertos/./tasks.c:4510
```

A full function option that is recommended is:

```
$ xtensa-esp32-elf-addr2line -pfiaC -e build/myapp.elf 40086c46
0x40086c46: xTaskCreatePinnedToCore at /home/kolban/esp32/esptest/esp-
idf/components/freertos/./tasks.c:4510
```

See also:

- [binutils – addr2line](#)
- [man\(1\) – addr2line](#)

## Core dump processing

When a computer program runs, there is always "state" associated with that program. At a minimum, there is the current location at which the program is executing (this is called the "program counter"). In addition, there are the values of variables currently in effect as well as the stack which contains information about the nested functions that may have been called to arrive at the current program location. Taken in aggregate, all this information can be extremely useful to you should your program fail or crash unexpectedly. This set of information is sometimes called a memory dump or a system dump and in Unix terms it is called a "core dump". ESP32 architecture has decided to use the term "core dump".

When an ESP32 application fails, we can configure that application to generate a core dump that can subsequently be used for analysis. By default, the generation of a core dump is disabled. We can change the setting within "make menuconfig" under the settings:

Component config → ESP32-specific → Core dump destination

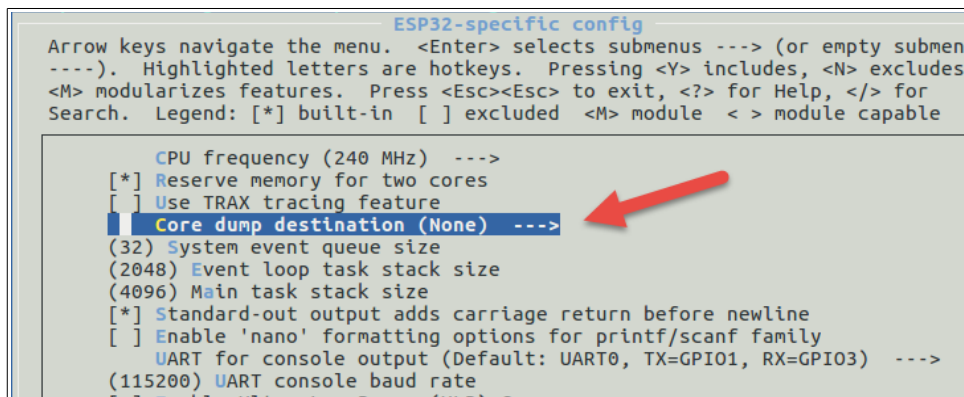

```
ESP32-specific config
Arrow keys navigate the menu. <Enter> selects submenus ---> (or empty submenu
--->). Highlighted letters are hotkeys. Pressing <Y> includes, <N> excludes
<M> modularizes features. Press <Esc><Esc> to exit, <?> for Help, </> for
Search. Legend: [*] built-in [ ] excluded <M> module < > module capable

CPU frequency (240 MHz) --->
[*] Reserve memory for two cores
[ ] Use TRAX tracing feature
[*] Core dump destination (None) --->
(32) System event queue size
(2048) Event loop task stack size
(4096) Main task stack size
[*] Standard-out output adds carriage return before newline
[ ] Enable 'nano' formatting options for printf/scanf family
UART for console output (Default: UART0, TX=GPI01, RX=GPI03) --->
(115200) UART console baud rate
```

If we select that option, we will find it has three possible settings:

- Flash – The core dump data will be written to flash memory.
- UART – The core dump data will be encoded and written to the serial (UART) output stream.
- None – No core dump information will be saved or written.

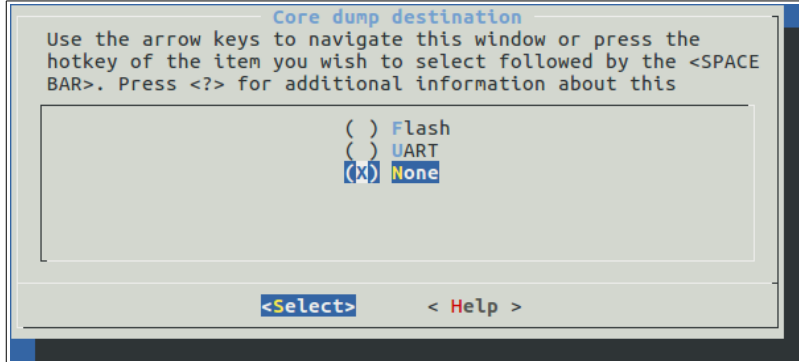

If we change the core dump destination to UART, an additional pair of options appear:

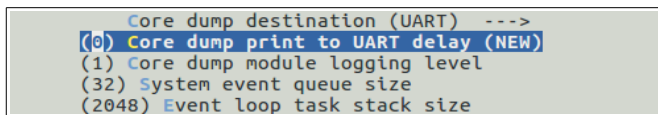

These are:

- Core dump print to UART delay – A time specified in milliseconds to pause before the core dump data is written to the console. This can be interrupted by a keystroke (assuming a terminal is attached). The default is 0 which means dump immediately.
- Core dump module logging level – This is a value between 0 (no output) and 5 (most verbose). It seems that this effects the debug output of the core dump generator as opposed to the content of the core dump itself.

There is a relationship between the core dump setting and what the ESP32 should do as a whole when there is a problem. The options for the ESP32 are found in

`Component config → ESP32-specific config → Panic handler behavior`

The options for that setting are:

- Print registers and halt
- Print registers and reboot
- Silent reboot
- Invoke GDBStub

For use with the core dump, I recommend "Print registers and halt".

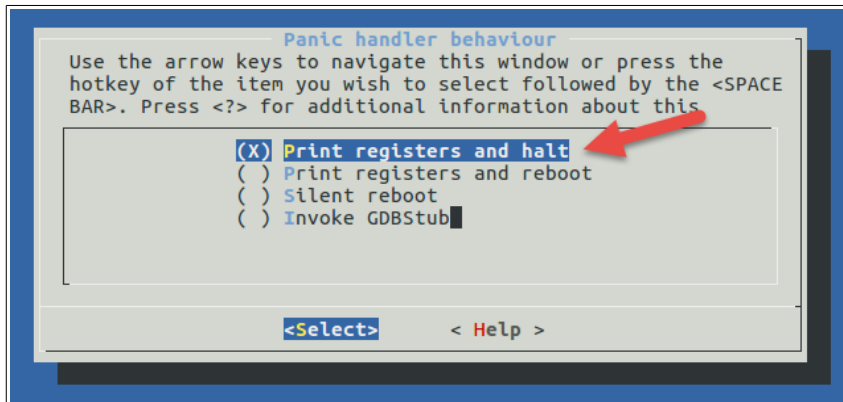

Once setup, when a fatal exception occurs, the following is an example of output:

```
Guru Meditation Error of type StoreProhibited occurred on core 0. Exception was
unhandled.
Register dump:
PC      : 0x400e6c23  PS      : 0x00060330  A0      : 0x800d0b41  A1      : 0x3ffb83b0
A2      : 0x00000000  A3      : 0x00000000  A4      : 0x00060023  A5      : 0x3ffb6c54
A6      : 0x00000000  A7      : 0x00000001  A8      : 0x0000007b  A9      : 0x3ffb8390
A10     : 0x000001f6  A11     : 0x3ffb1bf0  A12     : 0x3f4052a8  A13     : 0x0000001f
A14     : 0x00000001  A15     : 0x00000005  SAR     : 0x0000001b  EXCCAUSE: 0x0000001d

EXCVADDR: 0x00000000  LBEG    : 0x00000000  LEND    : 0x00000000  LCOUNT : 0x00000000

Backtrace: 0x400e6c23:0x3ffb83b0 0x400d0b41:0x3ffb83d0

===== CORE DUMP START =====
kA8AAAYAAABkAQAA
VGz7P/CC+z9QhPs/
cIP7P/CD+z/2AQASD37P0g9+z9UbPs/QD37PxcgAAAAAAAAAYogwEVRs+z8AAAAA
AQAAAFR0+z9tYWluAIgwIiJISgAAAAAAAAAAAFCE+z8AAAAAIAMGAAEAAAAAAAAA
AAAAAAAAAAAAAAAAAFT7P2hU+z/QVPs/AAAAAAAAABAAAAAAAAAIhCQD8AAAAA
...
AAAAAAAAAAAAAAAAAAAAAAAAAAAAAAAAAAAAAAAAAAAAAAAAAAAAAAAAAAAAAAAA
AAAAAAAAAAAAAAAAAAAAAAAAAAAAAAAAAAAAAAAAAAAAAAAAAAAAAAAAAAAAAAAA==
===== CORE DUMP END =====
CPU halted.
```

Once we have captured core dump data, the next step is to examine it to determine what it means. By and large it is a blob of binary data that by itself is not meaningful to us. Fortunately the ESP-IDF provides a tool to help us analyze it. That tool is called "espcoredump.py".

The primary input is a text file that contains the core dump output. This is the text **between** the "CORE DUMP START" and "CORE DUMP END" tags. This data is encoded in base 64. Once the file has been written (in the following examine into a file called core.dat), we can run the formatting command:

```
python $IDF_PATH/components/espcoredump/espcoredump.py info_corefile -t b64 -c
core.dat build/app-template.elf
```

Here is an example of the output of that tool:

```
=====
===== ESP32 CORE DUMP START =====

===== CURRENT THREAD REGISTERS =====
pc          0x400e6c17 0x400e6c17 <app_main+47>
lbeg        0x0 0
lend        0x0 0
lcount      0x0 0
sar         0x0 0
ps          0x60330 394032
threadptr   <unavailable>
br          <unavailable>
scompare1   <unavailable>
acclo       <unavailable>
acchi       <unavailable>
m0          <unavailable>
m1          <unavailable>
m2          <unavailable>
m3          <unavailable>
expstate    <unavailable>
f64r_lo     <unavailable>
f64r_hi     <unavailable>
f64s        <unavailable>
fcr         <unavailable>
fsr         <unavailable>
a0          0x3ffb83b0 1073447856
a1          0x0 0
a2          0x0 0
a3          0x60023 393251
a4          0x0 0
a5          0x0 0
a6          0x0 0
a7          0x0 0
a8          0x0 0
a9          0x0 0
a10         0x0 0
a11         0x0 0
a12         0x0 0
a13         0x0 0
a14         0x0 0
a15         0x0 0

===== CURRENT THREAD STACK =====
#0 0x400e6c17 in app_main () at
/home/kolban/esp32/esptest/apps/workspace/test_core_dump/main/./main.c:29

===== THREADS INFO =====
  Id  Target Id      Frame
   6   process 5      0x40082ae7 in xQueueGenericReceive (xQueue=0x0, pvBuffer=0x0,
xTicksToWait=<unavailable>, xJustPeeking=0) at /home/kolban/esp32/esptest/esp-
idf/components/freertos/./queue.c:1594
```

```

5 process 4          0x40082ae7 in xQueueGenericReceive (xQueue=0x1, pvBuffer=0x1,
xTicksToWait=<unavailable>, xJustPeeking=0) at /home/kolban/esp32/esptest/esp-
idf/components/freertos/./queue.c:1594
4 process 3          0x40084716 in prvProcessTimerOrBlockTask
(xNextExpireTime=<optimized out>, xListWasEmpty=<optimized out>) at
/home/kolban/esp32/esptest/esp-idf/components/freertos/./timers.c:487
3 process 2          0x400d13ac in esp_vApplicationIdleHook () at
/home/kolban/esp32/esptest/esp-idf/components/esp32/./freertos_hooks.c:52
2 process 1          0x400d13ac in esp_vApplicationIdleHook () at
/home/kolban/esp32/esptest/esp-idf/components/esp32/./freertos_hooks.c:52
* 1 <main task>     0x400e6c17 in app_main () at
/home/kolban/esp32/esptest/apps/workspace/test_core_dump/main/./main.c:29

```

```

===== ALL MEMORY REGIONS =====

```

```

Name Address Size Attrs
.rtc.text 0x400c0000 0x0 RW
.iram0.vectors 0x40080000 0x400 R XA
.iram0.text 0x40080400 0x13280 R XA
.dram0.data 0x3ffb0000 0x2434 RW A
.flash.rodata 0x3f400010 0x64b0 RW A
.flash.text 0x400d0018 0x18380 R XA
.coredump.tasks 0x3ffb6c54 0x164 RW
.coredump.tasks 0x3ffb82f0 0x160 RW
.coredump.tasks 0x3ffb8b10 0x164 RW
.coredump.tasks 0x3ffb89a0 0x164 RW
.coredump.tasks 0x3ffb845c 0x164 RW
.coredump.tasks 0x3ffb7190 0x16c RW
.coredump.tasks 0x3ffb92b8 0x164 RW
.coredump.tasks 0x3ffb91c0 0xec RW
.coredump.tasks 0x3ffb631c 0x164 RW
.coredump.tasks 0x3ffb6230 0xe0 RW
.coredump.tasks 0x3ffb5c14 0x164 RW
.coredump.tasks 0x3ffb5b20 0xe8 RW

```

```

===== ESP32 CORE DUMP END =====

```

At first glance, it looks like it contains a bewildering amount of data ... too much to make sense of, however, I hope you will take the time to learn how to interpret it as there is much to see. Lets start at the top section called:

```
CURRENT THREAD REGISTERS
```

These are the CPU registers in effect when the exception happened. Personally, there is little there that I can interpret with one important exception which is "pc". This is the "Program Counter" which is the address of the instruction that was being executed when the exception was encountered. An address by itself though isn't that useful.

Next comes the section called:

```
CURRENT THREAD STACK
```

This is where things get interesting. This contains the call stack of the current thread ... the one that contained the exception. Here we will see the path of nested calls that took

us to our failure. The final element in the list is exactly where the failure was encountered. For example:

```
#0 0x400e6c17 in app_main () at
/home/kolban/esp32/esptest/apps/workspace/test_core_dump/main/./main.c:29
```

But this time ... notice that the source file and exact line number within the source is displayed. We can't get much more precise than this. I believe that this is the most important information that we can glean from the examination of the core.

Next we find a section called:

```
THREADS INFO
```

This contains a record for each "thread" or FreeRTOS task running in the ESP32. This can provide a context on what else may have been running.

Finally we have a section called:

```
ALL MEMORY REGIONS
```

This lists all the memory sections within the environment. Good to see where things are mapped and useful to see if we might be treading on storage we don't own.

See also:

- [ESP-IDF documentation on core dump processing](#)
- [Wikipedia – core dump](#)

### Using a debugger (GDB)

GDB is the GNU Debugger and is an excellent tool for debugging compiled C source code. Although it is primarily designed to debug OS hosted applications such as those compiled for Windows or Linux it can be used to debug code on the ESP32.

First we must change a configuration setting in our compilation process for our ESP32 application using "make menuconfig". Visit the menu setting:

Component config → FreeRTOS → Panic handler behavior

From there, select "Invoke GDBStub":

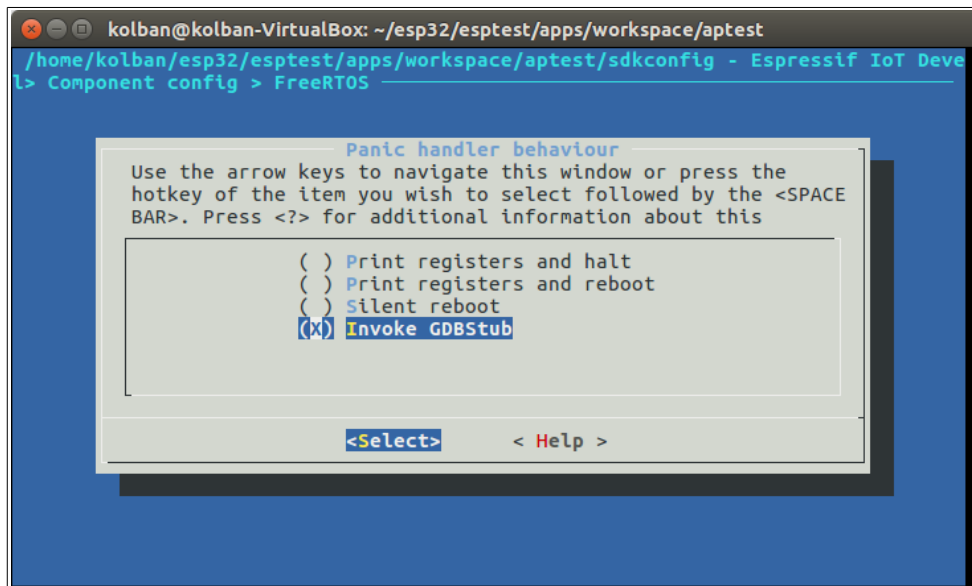

Now rebuild and re-deploy your solution. Now the next time a crash/exception happens in your ESP32 application, you will enter a GDB state where you can run `xtensa-esp32-elf-gdb` on your PC and use a serial connection to interact with the ESP32. For example:

```
xtensa-esp32-elf-gdb ./build/app-template.elf -b 115200 -ex 'target remote /dev/ttyUSB0'
```

You will now be in a gdb session where you can execute the normal gdb commands you would use for debugging.

See also:

- [Debugging with Visual Studio Code](#)

## OpenOCD and JTAG

We must install the Espressif distributed version of OpenOCD. We can build from source or download the binary.

To download the binary, see the following page:

- [Setup OpenOCD for Linux](#)

At the time of writing, these are the steps.

- Visit the Github release page ... <https://github.com/espressif/openocd-esp32/releases>
- Download the appropriate release / binary
  - For example



```
wget https://github.com/espressif/openocd-esp32/releases/download/v0.10.0-esp32-20180724/openocd-esp32-macos-0.10.0-esp32-20180724.tar.gz
```

- Extract the files

```
$ tar -xvf openocd-esp32-linux64-0.10.0-esp32-2018-07-24.tar.gz
$ rm openocd-esp32-linux64-0.10.0-esp32-2018-07-24.tar.gz
$ cd openocd-esp32
```

To build from source, perform the following:

1. `sudo apt-get install libusb-1.0`
2. `git clone --recursive https://github.com/espressif/openocd-esp32.git`
3. `cd openocd-esp32`
4. `git submodule init`
5. `git submodule update`
6. `./bootstrap`
7. `./configure`
8. `make`
9. `cp $IDF_PATH/docs/api-guides/esp32.cfg .`

For my testing I bought an FTDI based C232HM-DDHSL-0. These run about \$40 on eBay. The pin codings are:

Function	Id	Wire color
VCC	1	Red
TCK – Test Interface Clock	2	Orange
TDI – Test Data Input	3	Yellow
TDO – Test Data Output	4	Green
TMS – Test Mode Select	5	Brown
GPIOL0	6	Grey
GPIOL1	7	Purple
GPIOL2	8	White
GPIOL3	9	Blue
GND	10	Black

Given the four signals needed for JTAG (TCK, TDI, TDO and TMS), these can be found mapped to the following ESP32 pins:

JTAG function	GPIO	Wire color
TCK	GPIO 13	Orange
TDI	GPIO 12	Yellow
TDO	GPIO 15	Green
TMS	GPIO 14	Brown

## A clean start of openocd looks like:

```
$ sudo bin/openocd \
  -s share/openocd/scripts \
  -f interface/ftdi/esp32_devkitj_v1.cfg \
  -f board/esp32-wrover.cfg
Open On-Chip Debugger 0.10.0-dev-g07baed8 (2018-02-23-08:56)
Licensed under GNU GPL v2
For bug reports, read
    http://openocd.org/doc/doxygen/bugs.html
none separate
adapter speed: 20000 kHz
esp32 interrupt mask on
force hard breakpoints
Info : ftdi: if you experience problems at higher adapter clocks, try the command
"ftdi_tdo_sample_edge falling"
Info : clock speed 20000 kHz
Info : JTAG tap: esp32.cpu0 tap/device found: 0x120034e5 (mfg: 0x272 (Tensilica),
part: 0x2003, ver: 0x1)
Info : JTAG tap: esp32.cpu1 tap/device found: 0x120034e5 (mfg: 0x272 (Tensilica),
part: 0x2003, ver: 0x1)
Info : esp32: Debug controller was reset (pwrstat=0x5F, after clear 0x0F).
Info : esp32: Core was reset (pwrstat=0x5F, after clear 0x0F).
cpu0: Current bits set: BreakIn BreakOut RunStallIn
cpu1: Current bits set: none
```

By default, openocd binds to port 6666. Ensure that it is not already in use otherwise you may get an error such as:

```
Error: couldn't bind tcl to socket: Address already in use
```

We can restart the ESP32 with `mon reset`.

The launch command for gdb is

```
xtensa-esp32-elf-gdb -ex 'target remote localhost:3333' ./build/app-template.elf
```

This command says: "Run the xtensa ESP32 `gdb` program and execute the single command that is `target remote localhost:3333` against the executable called `./build/app-template.elf`".

See also:

- [Debugging with Visual Studio Code](#)
- [ESP-IDF Programming Guide: JTAG Debugging](#)

- [Open On-Chip Debugger – OpenOCD](#)
- [OpenOCD docs – PDF](#)
- [Github: espressif/openocd-esp32](#)
- [FTDI C232HM Data Sheet](#)
- FT2232H – Dual USB

### Using the ESP-WROVER-KIT for JTAG

To use the ESP-WROVER-KIT for JTAG you have to make some jumper bridges on JP8. Specifically, I find that I needed TMS, TDO, TDI and TCK bridged.

### Port numbers for openocd

Running openocd causes us to listen on some port numbers. The defaults appear to be 6666. This can cause problems as this port might be used by other applications. For example SourceTrail with Eclipse enabled uses that by default.

If there is a conflict, you might see an error message such as:

```
Error: couldn't bind tcl to socket: Address already in use
```

If you are running Linux, you might try running

```
$ lsof -i :6666
```

which lists which applications are using that port.

### **Dumping IP Addresses**

Being a WiFi and TCP/IP device, you would imagine that the ESP32 works a lot with IP addresses and you would be right. We can generate a string representation of an IP address using:

```
printf(IPSTR, IP2STR(pIpAddrVar))
```

the IPSTR macro is "%d.%d.%d.%d" so the above is equivalent to:

```
printf("%d.%d.%d.%d", IP2STR(pIpAddrVar))
```

which may be more useful in certain situations. The IP2STR macro takes a 32bit integer (an IP address) and produces 4 bytes worth of parameters corresponding to the 4 bytes of an IP address.

See also:

- IP2STR

## Debugging and testing TCP and UDP connections

When working with TCP/IP, you will likely want to have some applications that you can use to send and receive data so that you can be sure the ESP32 is working. There are a number of excellent tools and utilities available and these vary by platform and function.

### Android - Socket Protocol

The Socket Protocol is a free Android app available from the Google play app store.

See:

- <https://play.google.com/store/apps/details?id=aprisco.app.android>

### Android - UDP Sender/Receiver

The UDP Sender/Receiver is another free Android app available from the Google play app store. What makes this one interesting is its ability to be a UDP (as opposed to TCP) sender and receiver.

See also:

- <https://play.google.com/store/apps/details?id=com.jca.udpsendreceive>

### Android - tPacketCapture

Imagine you wish to examine traffic being sent and received by your Android device. The package called `tPacketCapture` can do just this. It saves the results as PCAP files that can be opened by Wireshark.

See also:

- <https://play.google.com/store/apps/details?id=jp.co.taosoftware.android.packetcapture&hl=en>

### Windows - Hercules

Hercules is an older app for Windows that still seems to work just fine on the latest releases. It looks a little old in the tooth now but still seems to get the job done just fine.

See also:

- [http://www.hw-group.com/products/hercules/index\\_en.html](http://www.hw-group.com/products/hercules/index_en.html)

### SocketTest

This is a Java app that also works well on Windows. Again, an old app but works exactly as advertised. Nothing fancy.

See also:

- <http://sockettest.sourceforge.net/>

### Linux - netcat (nc)

Netcat can send and receive arbitrary data over TCP/UDP.

For example, to listen on UDP and dump the incoming data:

```
$ nc -u -l -p 9999 | od -x
```

To listen on a TCP port and dump the incoming data:

```
$ nc -l -p 9999 -k | od -x
```

See also:

- [man\(1\)-nc](#)
- [man\(1\)-od](#)

### Curl

Curl is powerful and comprehensive command line tool for performing any and all URL related commands. It can transmit HTTP requests of all different formats and receive their responses. It has a bewildering set of parameters available to it which is both a blessing and curse. You can be pretty sure that if it can be done, Curl can do it ... however be prepared to wade through a lot of documentation.

Here are some simple recipes for some of the more common curl commands:

Issue a get against a target:

```
$ curl http://hostname
```

Send data in an HTTP post:

```
$ curl http://hostname --data "data to send"
```

Include an additional header:

```
$ curl http://hostname --header "name: value"
```

Redirect the output to a file

```
$ curl http://hostname --output <filename>
```

See also:

- Making a REST request using Curl
- [Curl](#)
- [Curl C API](#)

- [curl\\_easy\\_setopt](#)
- [libcurl examples](#)

### Eclipse - TCP/MON

One of the most powerful and useful tools available is called TCP/IP Monitor that is supplied as part of Eclipse and distributed with the "Eclipse Web Developer Tools". The TCP/IP monitor is opened through the Eclipse view called "TCP/IP Monitor".

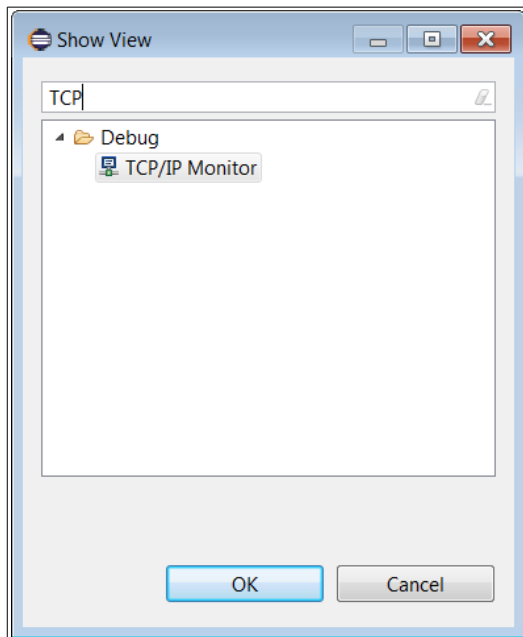

If you can't find it in the view finder, the chances are high that you haven't installed "Eclipse Web Developer Tools". Once launched, open its properties pane:

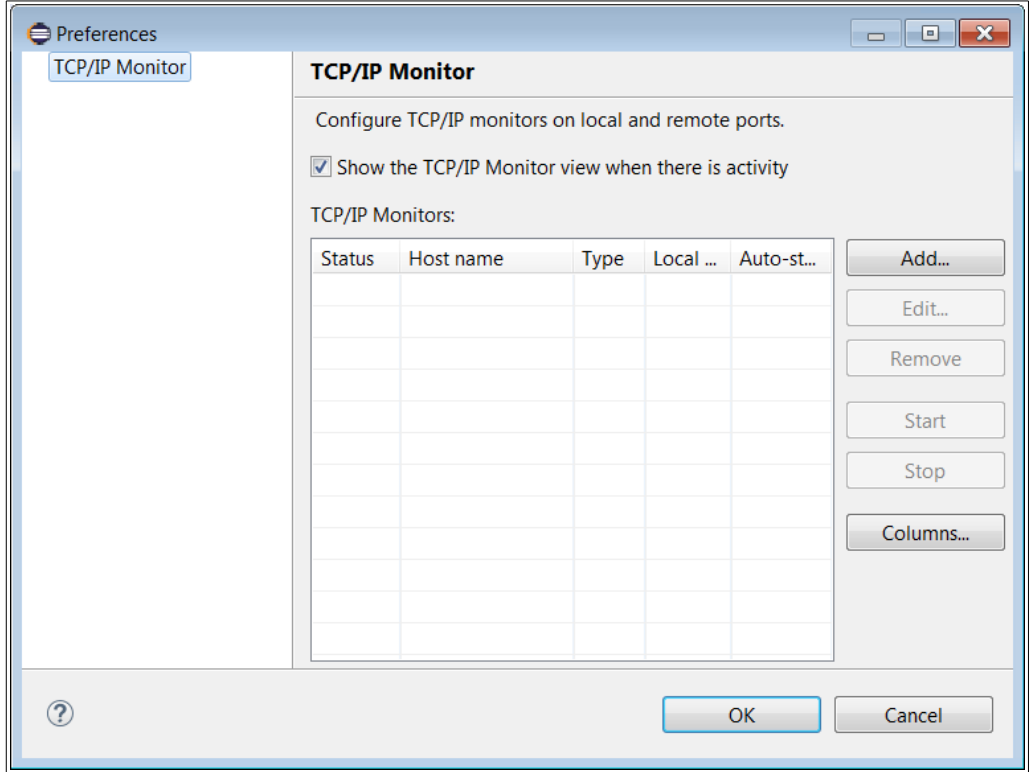

From there you can add local listeners. These will be TCP/IP listeners that listen on a local port where Eclipse is running. During configuration, you specify another IP address and port number. When TCP traffic now arrives at the listener on which TCP/IP Monitor is watching, it will forward that traffic to the partner while at the same time logging it to the TCP/IP Monitor screen.

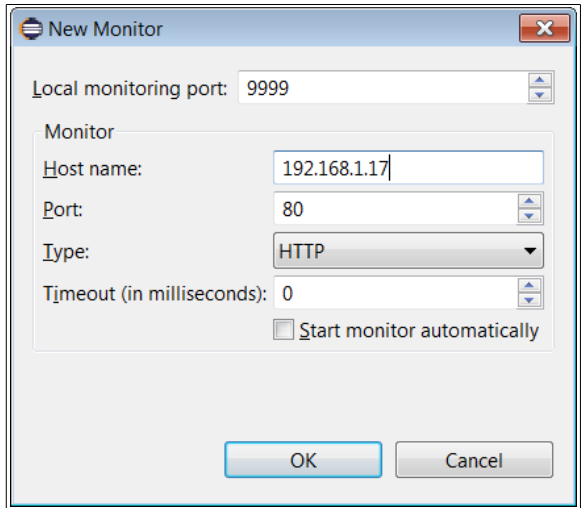

For example, here TCP/IP Monitor is listening on 192.168.1.2 (localhost) which is where Eclipse is running. It is listening on port 9999. When TCP/IP traffic arrives at that address, it will be sent onwards to 192.168.1.17 (which happens to be my ESP32 device) to port 80.

Here is an example of log I saw when sending a browser request:

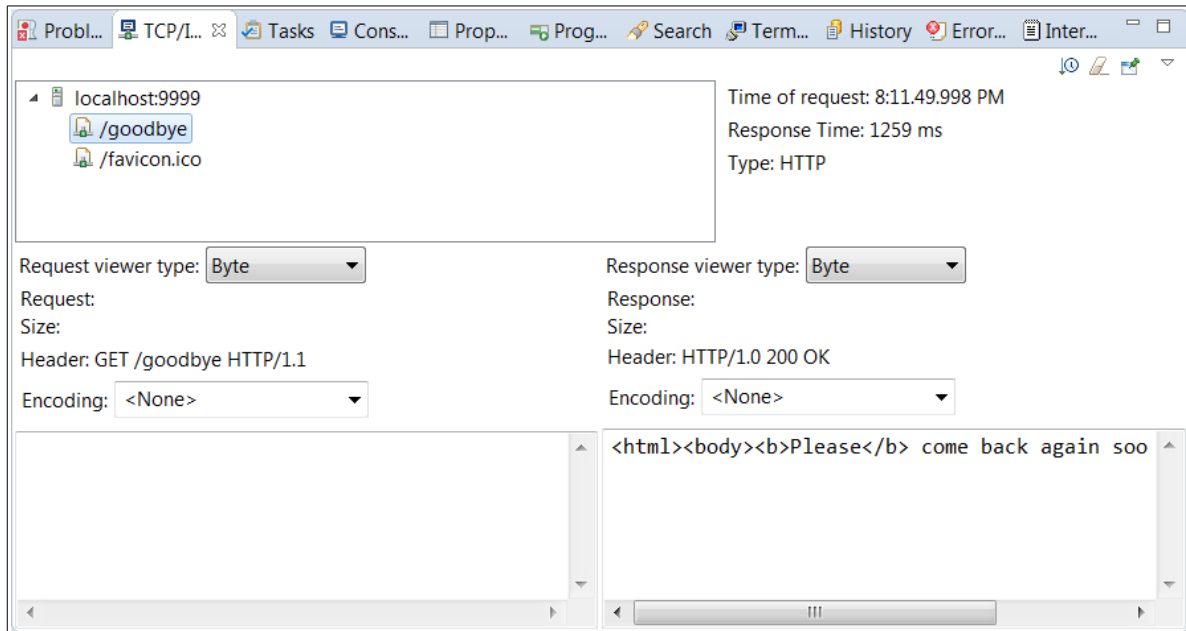

As you can see, the information captured here is powerful stuff. We can see each traffic request, its content and HTTP headers.

### [httpbin.org](http://httpbin.org)

When testing HTTP protocols, connecting to the web site at <http://httpbin.org> can be invaluable. It provides a host of services for testing HTTP requests.

### [RequestBin](http://requestbin.in/)

Another excellent HTTP testing resource. We can send a request to a URL and then see exactly what was received by the target. The URL for this service is <http://requestbin.in/>.



## tcpdump

This Linux based tool can capture and report on IP traffic into and out of your PC. Where this might be useful for our ESP32 work is that if we direct traffic from the ESP32 to a Linux app, we can look at the low level protocol.

## ESP-IDF component debugging

Some of the components of the ESP-IDF have their own debugging techniques and have special instructions for enablement.

## LWIP

In `lwipopts.h` change the `#define` for `LWIP_DEBUG` to `LWIP_DBG_ON`. This is the master debug flag. However there are sub components that then declare what to debug.

These include:

- `DNS_DEBUG`

To enable these, edit the `component.mk` for LWIP and add `CFLAGS` with these variables set to `LWIP_DBG_ON`.

## Run a Blinky

Physically looking at an ESP32 there isn't much to see that tells you all is working well within it. There is a power light and a network transmission active light ... but that's about it. A technique that I recommend is to always have your device execute a "blinking led" which is commonly known as a "Blinky". This can be achieved by connecting a GPIO pin to a current limiting resistor and then to an LED. When the GPIO signal goes high, the LED lights. When the GPIO signal goes low, the LED becomes dark. If we define a timer callback that is called (for example) once a second and toggles the GPIO pin signal value each invocation, we will have a simple blinking LED. You will be surprised how good a feeling it will give simply knowing that *something* is alive within the device each time you see it blink.

The cost of running the timer and changing the I/O value to achieve a blinking should not be a problem during development time so I wouldn't worry about side effects of doing this. Obviously for a published application, you may not desire this and can simply remove it.

However, although this is a trivial circuit, it has a lot of uses during development. First, you will always know that the device is operating. If the LED is blinking, you know the

device has power and logic processing control. If the light stops blinking, you will know that something has locked up or you have entered an infinite loop.

Another useful purpose for including the Blinky is to validate that you have entered flash mode when programming the device. If we understand that the device can boot up in normal or flash mode and we boot it up in flash mode, then the Blinky will stop executing. This can be useful if you are using buttons or jumpers to toggle the boot mode as it will provide evidence that you are *not* in normal mode. On occasion I have mis-pressed some control buttons and was quickly able to realize that something was wrong before even attempting to flash it as the Blinky was still going.

## WiFi subsystem

### WiFi Theory

When working with a WiFi oriented device, it is important that we have at least some understanding of the concepts related to WiFi. At a high level, WiFi is the ability to participate in TCP/IP connections over a wireless communication link. WiFi is specifically the set of protocols described in the IEEE 802.11 Wireless LAN architecture.

Within this story, a device called a Wireless Access Point (access point or AP) acts as the hub of all communications. Typically it is connected to (or acts as) as TCP/IP router to the rest of the TCP/IP network. For example, in your home, you are likely to have a WiFi access point connected to your modem (cable or DSL). WiFi connections are then formed to the access point (through devices called stations) and TCP/IP traffic flows through the access point to the Internet.



The devices that connect to the access points are called "stations":

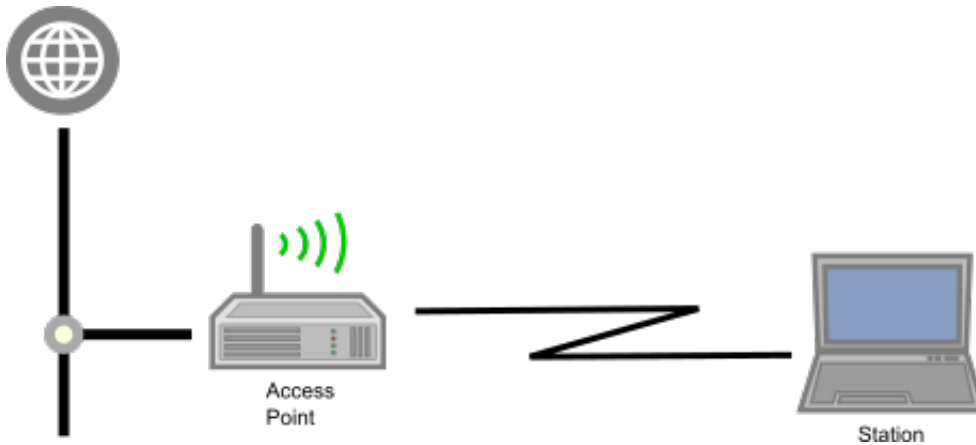

An ESP32 device can play the role of an Access Point, a Station or both at the same time.

Very commonly, the access point also has a network connection to the Internet and acts as a bridge between the wireless network and the broader TCP/IP network that is the Internet.

A collection of stations that wish to communicate with each other is termed a Basic Service Set (BSS). The common configuration is what is known as an Infrastructure BSS. In this mode, all communications inbound and outbound from an individual station are routed through the access point.

A station must associate itself with an access point in order to participate in the story. A station may only be associated with a single access point at any one time.

Each participant in the network has a unique identifier called the MAC address. This is a 48bit value.

When we have multiple access points within wireless range, the station needs to know with which one to connect. Each access point has a network identifier called the BSSID (or more commonly just SSID). SSID is **service set identifier**. It is a 32 character value that represents the target of packets of information sent over the network.

See also:

- Wikipedia – [Wireless access point](#)
- Wikipedia – [IEEE 802.11](#)
- Wikipedia – [WiFi Protected Access](#)
- Wikipedia – [IEEE 802.11i-2004](#)

## Initializing the WiFi environment

WiFi is only a part of the capabilities of an ESP32. As such, there may be some times when you actually don't want to use the WiFi subsystem. To accommodate those patterns, the initialization of the WiFi subsystem is expected to be performed by you when you write your applications. This is done by calling the `esp_wifi_init()` method. The recommended way of doing this is as follows:

```
wifi_init_config_t config = WIFI_INIT_CONFIG_DEFAULT();
esp_wifi_init(&config);
```

See also:

- `esp_wifi_init`

## Setting the operation mode

The ESP32 can either be a station in the network, an access point for other devices or both. Remember, when an ESP32 is being a station, it can connect to a remote access point (your WiFi hub) while when being an access point, other WiFi stations can connect to the ESP32 (think of the ESP32 as becoming a WiFi hub). This is a fundamental consideration and we will want to choose how the device behaves early on in our application design. Once we have chosen what we want, we set a global mode property which indicates which of the operational modes our device will perform (station, access point or station AND access point).

This choice is set with a call to `esp_wifi_set_mode()`. The parameter is an instance of `wifi_mode_t` which can have a value of `WIFI_MODE_NULL`, `WIFI_MODE_STA`, `WIFI_MODE_AP`

or `WIFI_MODE_APSTA`. We can call `esp_wifi_get_mode()` to retrieve our current mode state.

See also:

- `esp_wifi_set_mode`
- `esp_wifi_get_mode`

## Scanning for access points

If the ESP32 is going to be performing the role of a station we will need to connect to an access point. We can request a list of the available access points against which we can attempt to connect. We do this using the `esp_wifi_scan_start()` function.

The results of a WiFi scan are stored internally in ESP32 dynamically allocated storage. The data is returned to us when we call `esp_wifi_scan_get_ap_records()` which also releases the internally allocated storage. As such, this should be considered a destructive read.

A scan record is contained in an instance of a `wifi_ap_record_t` structure that contains:

```
uint8_t bssid[6]
uint8_t ssid[32]
uint8_t primary
wifi_second_chan_t second
int8_t rssi
wifi_auth_mode_t authmode
```

The `wifi_auth_mode_t` is one of:

- `WIFI_AUTH_OPEN` – No security.
- `WIFI_AUTH_WEP` – WEP security.
- `WIFI_AUTH_WPA_PSK` – WPA security.
- `WIFI_AUTH_WPA2_PSK` – WPA2 security.
- `WIFI_AUTH_WPA_WPA2_PSK` – WPA or WPA2 security.

After issuing the request to start performing a scan, we will be informed that the scan completed when a `SYSTEM_EVENT_SCAN_DONE` event is published. The event data contains the number of access points found but that can also be retrieved with a call to `esp_wifi_scan_get_ap_num()`.

Should we wish to cancel the scanning before it completes on its own, we can call `esp_wifi_scan_stop()`.

Here is a complete sample application illustrating performing a WiFi scan. Much of the work is performed in the event handler. When we detect a scan completion event, we retrieve the located access points and log their details.

```
#include "esp_wifi.h"
#include "esp_system.h"
#include "esp_event.h"
#include "esp_event_loop.h"
#include "nvs_flash.h"

esp_err_t event_handler(void *ctx, system_event_t *event)
{
    if (event->event_id == SYSTEM_EVENT_SCAN_DONE) {
        printf("Number of access points found: %d\n",
            event->event_info.scan_done.number);
        uint16_t apCount = event->event_info.scan_done.number;
        if (apCount == 0) {
            return ESP_OK;
        }
        wifi_ap_record_t *list =
            (wifi_ap_record_t *)malloc(sizeof(wifi_ap_record_t) * apCount);
        ESP_ERROR_CHECK(esp_wifi_scan_get_ap_records(&apCount, list));
        int i;
        for (i=0; i<apCount; i++) {
            char *authmode;
            switch(list[i].authmode) {
                case WIFI_AUTH_OPEN:
                    authmode = "WIFI_AUTH_OPEN";
                    break;
                case WIFI_AUTH_WEP:
                    authmode = "WIFI_AUTH_WEP";
                    break;
                case WIFI_AUTH_WPA_PSK:
                    authmode = "WIFI_AUTH_WPA_PSK";
                    break;
                case WIFI_AUTH_WPA2_PSK:
                    authmode = "WIFI_AUTH_WPA2_PSK";
                    break;
                case WIFI_AUTH_WPA_WPA2_PSK:
                    authmode = "WIFI_AUTH_WPA_WPA2_PSK";
                    break;
                default:
                    authmode = "Unknown";
                    break;
            }
            printf("ssid=%s, rssi=%d, authmode=%s\n",
                list[i].ssid, list[i].rssi, authmode);
        }
        free(list);
    }
    return ESP_OK;
}
```

```

}

int app_main(void)
{
    nvs_flash_init();
    tcpip_adapter_init();
    ESP_ERROR_CHECK(esp_event_loop_init(event_handler, NULL));
    wifi_init_config_t cfg = WIFI_INIT_CONFIG_DEFAULT();
    ESP_ERROR_CHECK(esp_wifi_init(&cfg));
    ESP_ERROR_CHECK(esp_wifi_set_storage(WIFI_STORAGE_RAM));
    ESP_ERROR_CHECK(esp_wifi_set_mode(WIFI_MODE_STA));
    ESP_ERROR_CHECK(esp_wifi_start());

    // Let us test a WiFi scan ...
    wifi_scan_config_t scanConf = {
        .ssid = NULL,
        .bssid = NULL,
        .channel = 0,
        .show_hidden = 1
    };
    ESP_ERROR_CHECK(esp_wifi_scan_start(&scanConf, 0));

    return 0;
}

```

Using the Arduino libraries we can also make network scans. Here is an example:

```

int8_t count = WiFi.scanNetworks();
printf("Found %d networks\n", count);
for (uint8_t i=0; i<count; i++) {
    String ssid;
    uint8_t encryptionType;
    int32_t RSSI;
    uint8_t *BSSID;
    int32_t channel;
    WiFi.getNetworkInfo(i, ssid, encryptionType, RSSI, BSSID, channel);
    printf("ssid=%s\n", ssid.c_str());
}

```

See also:

- [Handling WiFi events](#)
- [esp\\_wifi\\_scan\\_start](#)
- [esp\\_wifi\\_scan\\_stop](#)
- [esp\\_wifi\\_scan\\_get\\_ap\\_records](#)
- [esp\\_wifi\\_scan\\_get\\_ap\\_num](#)
- [nvs\\_flash\\_init](#)

## Handling WiFi events

During the course of operating as a WiFi device, certain events may occur that ESP32 needs to know about. These may be of importance or interest to the applications running within it. Since we don't know when, or even if, any events will happen, we can't have our application block waiting for them to occur. Instead what we should do is define a callback function that will be invoked should an event actually occur. The function called `esp_event_loop_init()` does just that. It registers a function that will be called when the ESP32 detects certain types of WiFi related events. The registered function is invoked and passed a rich data structure that includes the type of event and associated data corresponding to that event. The types of events that cause the callback to occur are:

- We connected to an access point
- We disconnected from an access point
- The authorization mode changed
- A station connected to us when we are in Access Point mode
- A station disconnected from us when we are in Access Point mode
- A SSID scan completes

When the ESP32 WiFi environment operates, it publishes "events" when something at the WiFi level occurs such as a new station connecting. We can register a callback function that is invoked when an event is published. The signature of the callback function is:

```
esp_err_t eventHandler(void* ctx, system_event_t* event) {  
    // Handle event here ...  
    return ESP_OK;  
}
```

Typically, we need to also include the following:

- `#include <esp_event.h>`
- `#include <esp_event_loop.h>`
- `#include <esp_wifi.h>`
- `#include <esp_err.h>`

To register the callback function, we invoke:

```
esp_event_loop_init(eventHandler, NULL);
```

If we wish to subsequently change the event handler associated with our WiFi handling we can call:



```
esp_event_loop_set_cb(eventHandler, NULL);
```

When the event handler is invoked, the event parameter is populated with details of the event. The data type of this parameter is a "system\_event\_t" which contains:

```
system_event_id_t event_id
system_event_info_t event_info
```

We should include "esp\_event.h" to gain access to these functions and definitions. Let us now look at the two properties passed to the event handler in the system\_event\_t data structure. These properties are "event\_id" and "event\_info". At a high level, the event\_id describes what kind of event was detected while event\_info contains the specific details of the event based on the type identified in event\_id.

- event\_id – An enumeration type with the following potential values:
  - SYSTEM\_EVENT\_WIFI\_READY – ESP32 WiFi is ready. Although this is currently listed as an event type, it is not actually used and may be removed from the ESP-IDF at some future date. Don't use it in your applications ... it will never arrive.
  - SYSTEM\_EVENT\_SCAN\_DONE – Finished scanning for access points. The scan\_done data field is valid to be accessed.
  - SYSTEM\_EVENT\_STA\_START – Started being a station. Received after a call to esp\_wifi\_start().
  - SYSTEM\_EVENT\_STA\_STOP – Stopped being a station.
  - SYSTEM\_EVENT\_STA\_CONNECTED – Connected to an access point as a station. The connected data field is valid to be accessed.
  - SYSTEM\_EVENT\_STA\_DISCONNECTED – Disconnected from access point while being a station. The disconnected data field is valid to be accessed. This event can occur as a result of a previous esp\_wifi\_disconnect() call.
  - SYSTEM\_EVENT\_STA\_AUTHMODE\_CHANGE – Authentication mode has changed. The auth\_change data field is valid to be accessed.
  - SYSTEM\_EVENT\_STA\_GOT\_IP – Got an assigned IP address from the access point that we connected to while being a station. The got\_ip data field is valid to be accessed.
  - SYSTEM\_EVENT\_STA\_LOST\_IP – Unknown

- `SYSTEM_EVENT_AP_START` – Started being an access point. Received after a call to `esp_wifi_start()`.
- `SYSTEM_EVENT_AP_STOP` – Stopped being an access point.
- `SYSTEM_EVENT_AP_STACONNECTED` – A station connected to us while we are being an access point. The `sta_connected` data field is valid to be accessed.
- `SYSTEM_EVENT_AP_STADISCONNECTED` – A station disconnected from us while we are being an access point. The `sta_disconnected` data field is valid to be accessed.
- `SYSTEM_EVENT_AP_STAIPASSIGNED` – A station has been assigned an IP address.
- `SYSTEM_EVENT_AP_PROBEREQRECVD` – Received a probe request while we are being an access point. The `ap_probereqrecvd` data field is valid to be accessed.
- `SYSTEM_EVENT_GOT_IP6` – Unknown
- `event_info` – This is a C language union of distinct data types that are keyed off the `event_id`. The different structures contained within are:

Structure	Field	Event
<code>system_event_sta_connected_t</code>	<code>connected</code>	<code>SYSTEM_EVENT_STA_CONNECTED</code>
<code>system_event_sta_disconnected_t</code>	<code>disconnected</code>	<code>SYSTEM_EVENT_STA_DISCONNECTED</code>
<code>system_event_sta_scan_done_t</code>	<code>scan_done</code>	<code>SYSTEM_EVENT_SCAN_DONE</code>
<code>system_event_sta_authmode_change_t</code>	<code>auth_change</code>	<code>SYSTEM_EVENT_STA_AUTHMODE_CHANGE</code>
<code>system_event_sta_got_ip_t</code>	<code>got_ip</code>	<code>SYSTEM_EVENT_STA_GOT_IP</code>
<code>system_event_ap_staconnected_t</code>	<code>sta_connected</code>	<code>SYSTEM_EVENT_AP_STACONNECTED</code>
<code>system_event_ap_stadisconnected_t</code>	<code>sta_disconnected</code>	<code>SYSTEM_EVENT_AP_STADISCONNECTED</code>
<code>system_event_ap_probe_req_rx_t</code>	<code>ap_probereqrecvd</code>	<code>SYSTEM_EVENT_AP_PROBEREQRECVD</code>

These data structures contain information pertinent to the event type received.

### **`system_event_sta_connected_t`**

This data type is associated with the `SYSTEM_EVENT_STA_CONNECT` event.

```
uint8_t ssid[32]
uint8_t ssid_len
uint8_t bssid[6]
uint8_t channel
wifi_auth_mode_t authmode
```

The `ssid` is the WiFi network name to which we connected. The `ssid_len` is the number of bytes in the `ssid` field that contain the name. The `bssid` is the MAC address of the access point. The `channel` is the wireless channel used for the connection. The `authmode` is the security authentication mode used during the connection.

### **system\_event\_sta\_disconnected\_t**

This data type is associated with the `SYSTEM_EVENT_STA_DISCONNECTED` event.

```
uint8_t ssid[32]
uint8_t ssid_len
uint8_t bssid[6]
uint8_t reason
```

The reason code is an indication of why we disconnected. Symbolics are defined for each of the numeric reason codes to allow us to write more elegant and comprehensible applications should we need to consider a reason code.:

- `WIFI_REASON_UNSPECIFIED` – 1
- `WIFI_REASON_AUTH_EXPIRE` – 2
- `WIFI_REASON_AUTH_LEAVE` – 3
- `WIFI_REASON_ASSOC_EXPIRE` – 4
- `WIFI_REASON_ASSOC_TOOMANY` – 5
- `WIFI_REASON_NOT_AUTHED` – 6
- `WIFI_REASON_NOT_ASSOCED` – 7
- `WIFI_REASON_ASSOC_LEAVE` – 8
- `WIFI_REASON_ASSOC_NOT_AUTHED` – 9
- `WIFI_REASON_DISASSOC_PWRCAP_BAD` – 10

- `WIFI_REASON_DISASSOC_SUPCHAN_BAD` – 11
- `WIFI_REASON_IE_INVALID` – 13
- `WIFI_REASON_MIC_FAILURE` – 14
- `WIFI_REASON_4WAY_HANDSHAKE_TIMEOUT` – 15
- `WIFI_REASON_GROUP_KEY_UPDATE_TIMEOUT` – 16
- `WIFI_REASON_IE_IN_4WAY_DIFFERS` – 17
- `WIFI_REASON_GROUP_CIPHER_INVALID` – 18
- `WIFI_REASON_PAIRWISE_CIPHER_INVALID` – 19
- `WIFI_REASON_AKMP_INVALID` – 20
- `WIFI_REASON_UNSUPP_RSN_IE_VERSION` – 21
- `WIFI_REASON_INVALID_RSN_IE_CAP` – 22
- `WIFI_REASON_802_1X_AUTH_FAILED` – 23
- `WIFI_REASON_CIPHER_SUITE_REJECTED` – 24
- `WIFI_REASON_BEACON_TIMEOUT` – 200
- `WIFI_REASON_NO_AP_FOUND` – 201
- `WIFI_REASON_AUTH_FAIL` – 202
- `WIFI_REASON_ASSOC_FAIL` – 203
- `WIFI_REASON_HANDSHAKE_TIMEOUT` – 204

## **system\_event\_sta\_scan\_done\_t**

This data type is associated with the `SYSTEM_EVENT_SCAN_DONE` event.

```
uint32_t status
uint8_t number
uint8_t scan_id
```

See also:

- Scanning for access points
- `esp_wifi_scan_get_ap_records`

## **system\_event\_authmode\_change\_t**

This data type is associated with the `SYSTEM_EVENT_STA_AUTHMODE_CHANGE` event.

```
wifi_auth_mode_t old_mode  
wifi_auth_mode_t new_mode
```

### **system\_event\_sta\_got\_ip\_t**

This data type is associated with the `SYSTEM_EVENT_STA_GOT_IP` event.

```
tcpip_adapter_ip_info_t ip_info
```

The `ip_info` element is an instance of a `tcpip_adapter_ip_info_t` which contains three fields:

- `ip` -The IP address.
- `netmask` – The network mask.
- `gw` – The gateway for communications.

All three of these fields are of `ip4_addr_t` which is a 32bit representation of an IP address. During development, you might want to consider logging the IP address of the device. You can do this using:

```
ESP_LOGD(tag, "Got an IP: " IPSTR, IP2STR(&event->event_info.got_ip.ip_info.ip));
```

### **system\_event\_ap\_staconnected\_t**

This data type is associated with the `SYSTEM_EVENT_AP_STACONNECTED` event.

```
uint8_t mac[6]  
uint8_t aid
```

### **system\_event\_ap\_stadisconnected\_t**

This data type is associated with the `SYSTEM_EVENT_AP_STADISCONNECTED` event.

```
uint8_t mac[6]  
uint8_t aid
```

### **system\_event\_ap\_probe\_req\_rx\_t**

This data type is associated with the `SYSTEM_EVENT_AP_PROBREQRCVD` event.

```
int rssi
```

```
uint8_t mac[6]
```

If we enable the correct logging levels, we can see the events arrive and their content. For example:

```
D (2168) event: SYSTEM_EVENT_STA_CONNECTED, ssid:RASPI3, ssid_len:6,
bssid:00:00:13:80:3d:bd, channel:6, authmode:3
V (2168) event: enter default callback
V (2174) event: exit default callback
```

and

```
D (9036) event: SYSTEM_EVENT_STA_GOTIP, ip:192.168.5.62, mask:255.255.255.0,
gw:192.168.5.1
V (9036) event: enter default callback
I (9037) event: ip: 192.168.5.62, mask: 255.255.255.0, gw: 192.168.5.1
V (9043) event: exit default callback
```

## Station configuration

When we think of an ESP32 as a WiFi Station, we will realize that at any one time, it can only be connected to one access point. Putting it another way, there is no meaning in saying that the device is connected to **two** or more access points at the same time.

The identity of the access point to which we wish to be associated is set within a data structure called `wifi_sta_config_t`.

The `wifi_sta_config_t` contains:

```
char ssid[32]
char password[64]
bool bssid_set
uint8_t bssid[6]
```

Contained within that structure are two very important fields called "ssid" and "password". The `ssid` field is the SSID of the access point to which we will connect. The `password` field is the clear text value of the password that will be used to authenticate our device to the target access point to allow connection.

An example initialization for this structure might be:

```
wifi_config_t staConfig = {
    .sta = {
        .ssid="<access point name>",
        .password="<password>",
        .bssid_set=false
    }
};
```

Once we have populated an instance of this structure, we can instruct ESP32 about its content using:

```
esp_wifi_set_config(WIFI_IF_STA, (wifi_config_t *)&staConfig);
```

We should previously have called `esp_wifi_set_mode()`. with either:

```
esp_wifi_set_mode(WIFI_MODE_STA)
```

or

```
esp_wifi_set_mode(WIFI_MODE_APSTA)
```

See also:

- `esp_wifi_set_mode`
- `esp_wifi_set_config`

## Starting up the WiFi environment

Since WiFi has states that it must go through, a question that may be asked is "When is WiFi ready to be used?". If we imagine that an ESP32 boots from cold, the chances are that we want to tell it to be either a station or an access point and then configure it with parameters such as which access point to connect to (if it is a station) or what its own access point identity should be (if it is going to be an access point). Given that these are a sequence of steps, we actually don't want the ESP32 to execute on these tasks until after we have performed all our setup. For example, if we boot an ESP32 and ask it to be an access point, if it started being an access point immediately then it may not yet know the details of the access point it should be or, worse, may transiently appear as the wrong access point. As such, there is final command that we must learn which is the instruction to the WiFi subsystem to start working. That command is

`esp_wifi_start()`. Prior to calling that, all we are doing is setting up the environment.

Only by calling `esp_wifi_start()` does the WiFi subsystem start doing any real work on our behalf. If our mode is that of an access point, calling this function will start us being an access point. If our mode is that of a station, now we are allowed to subsequently connect as a station. There is a corresponding command called `esp_wifi_stop()` which stops the WiFi subsystem.

We should not perform **any** additional networking or WiFi work until we receive the corresponding event (`SYSTEM_EVENT_STA_START` or `SYSTEM_EVENT_AP_START`) to indicate that WiFi has started.

See also:

- `esp_wifi_start`
- `esp_wifi_stop`

## Connecting to an access point

Once the ESP32 has been set up with the station configuration details, which includes the SSID and password, we are ready to perform a connection to the target access point. The function `esp_wifi_connect()` will form the connection. Realize that this is not instantaneous and you should not assume that immediately following this command you are connected. Nothing in the ESP32 blocks and as such neither does the call to this function. Some time later, we will actually be connected. We will see two callback events fired. The first is `SYSTEM_EVENT_STA_CONNECTED` indicating that we have connected to the access point. The second event is `SYSTEM_EVENT_STA_GOT_IP` which indicates that we have been assigned an IP address by the DHCP server. Only at that point can we truly participate in communications. If we are using static IP addresses for our device, then we will only see the connected event.

Should we disconnect from an access point, we will see a `SYSTEM_EVENT_STA_DISCONNECTED` event. To disconnect from a previously connected access point we issue the `esp_wifi_disconnect()` call.

There is one further consideration associated with connecting to access points and that is the idea of automatic connection. There is a boolean flag that is stored in flash that indicates whether or not the ESP32 should attempt to automatically connect to the last used access point. If set to true, then after the device is started and without you having to code any API calls, it will attempt to connect to the last used access point. This is a convenience that I prefer to switch off. Usually, I want control in my device to determine when I connect. We can enable or disable the auto connect feature by making a call to `esp_wifi_set_auto_connect()`.

Here is a complete sample illustrating all the steps needed to connect to an access point and be informed when we are ready to being work:

```
#include <freertos/FreeRTOS.h>
#include <esp_wifi.h>
#include <esp_system.h>
#include <esp_event.h>
#include <esp_event_loop.h>
#include <nvs_flash.h>
#include <tcpip_adapter.h>

esp_err_t event_handler(void *ctx, system_event_t *event)
{
    if (event->event_id == SYSTEM_EVENT_STA_GOT_IP) {
        printf("Our IP address is " IPSTR "\n",
            IP2STR(&event->event_info.got_ip.ip_info.ip));
        printf("We have now connected to a station and can do things...\n");
    }
    if (event->event_id == SYSTEM_EVENT_STA_START) {
        ESP_ERROR_CHECK(esp_wifi_connect());
    }
}
```



```

    return ESP_OK;
}

int app_main(void)
{
    nvs_flash_init();
    tcpip_adapter_init();
    ESP_ERROR_CHECK( esp_event_loop_init(event_handler, NULL) );
    wifi_init_config_t cfg = WIFI_INIT_CONFIG_DEFAULT();
    ESP_ERROR_CHECK( esp_wifi_init(&cfg) );
    ESP_ERROR_CHECK( esp_wifi_set_storage(WIFI_STORAGE_RAM) );
    ESP_ERROR_CHECK( esp_wifi_set_mode(WIFI_MODE_STA) );
    wifi_config_t sta_config = {
        .sta = {
            .ssid = "RASPI3",
            .password = "password",
            .bssid_set = 0
        }
    };
    ESP_ERROR_CHECK( esp_wifi_set_config(WIFI_IF_STA, &sta_config) );
    ESP_ERROR_CHECK( esp_wifi_start() );

    return 0;
}

```

When we connect to an access point, our device is being a station. The connection to the access point doesn't automatically mean that we now have an IP address. We still have to request an allocated IP address from the DHCP server. This can take a few seconds. In some cases, we can get away with the device requesting a specific IP address. This results in a much faster connection time. If we do specify data, we also need to supply DNS information should we need to connect to DNS servers for name resolution.

Here is a fragment of logic that allocates us a specific IP address:

```

#include <lwip/sockets.h>

// The IP address that we want our device to have.
#define DEVICE_IP          "192.168.1.99"

// The Gateway address where we wish to send packets.
// This will commonly be our access point.
#define DEVICE_GW          "192.168.1.1"

// The netmask specification.
#define DEVICE_NETMASK     "255.255.255.0"

// The identity of the access point to which we wish to connect.
#define AP_TARGET_SSID     "RASPI3"

```

```

// The password we need to supply to the access point for authorization.
#define AP_TARGET_PASSWORD "password"

esp_err_t wifiEventHandler(void *ctx, system_event_t *event)
{
    if (event->event_id == SYSTEM_EVENT_STA_START) {
        ESP_ERROR_CHECK(esp_wifi_connect());
    }
    return ESP_OK;
}

// Code fragment here ...
nvs_flash_init();
tcpip_adapter_init();

tcpip_adapter_dhcpc_stop(TCPIP_ADAPTER_IF_STA); // Don't run a DHCP client
tcpip_adapter_ip_info_t ipInfo;

inet_pton(AF_INET, DEVICE_IP, &ipInfo.ip);
inet_pton(AF_INET, DEVICE_GW, &ipInfo.gw);
inet_pton(AF_INET, DEVICE_NETMASK, &ipInfo.netmask);
tcpip_adapter_set_ip_info(TCPIP_ADAPTER_IF_STA, &ipInfo);

ESP_ERROR_CHECK(esp_event_loop_init(wifiEventHandler, NULL));
wifi_init_config_t cfg = WIFI_INIT_CONFIG_DEFAULT();
ESP_ERROR_CHECK(esp_wifi_init(&cfg) );
ESP_ERROR_CHECK(esp_wifi_set_storage(WIFI_STORAGE_RAM));
ESP_ERROR_CHECK(esp_wifi_set_mode(WIFI_MODE_STA));
wifi_config_t sta_config = {
    .sta = {
        .ssid      = AP_TARGET_SSID,
        .password  = AP_TARGET_PASSWORD,
        .bssid_set = 0
    }
};
ESP_ERROR_CHECK(esp_wifi_set_config(WIFI_IF_STA, &sta_config));
ESP_ERROR_CHECK(esp_wifi_start());

```

## See also:

- [Handling WiFi events](#)
- [esp\\_wifi\\_connect](#)
- [esp\\_wifi\\_disconnect](#)

## Being an access point

So far we have only considered the ESP32 as a WiFi station to an existing access point but it also has the ability to **be** an access point to other WiFi devices (stations) including other ESP32s.

In order to be an access point, we need to define the SSID that allows other devices to distinguish our network. This SSID can be flagged as hidden if we don't wish it to be found in a scan. In addition, we will also have to supply the authentication mode that will be used when a station wishes to connect with us. This is used to allow authorized stations only and prevent un-authorized ones. Only stations that know our password will be allowed to connect. If we are using authentication, then we will also have to choose a password which the connecting stations will have to know and supply to successfully connect.

The first task in being an access point is to flag the ESP32 as being such using the `esp_wifi_set_mode()` function and pass in the flag that requests we be either a dedicated access point or an access point **and** a station. This will be either:

```
esp_wifi_set_mode(WIFI_MODE_AP);
```

or

```
esp_wifi_set_mode(WIFI_MODE_APSTA);
```

Next we need to supply the configuration information. We do this by populating an instance of `wifi_ap_config_t`. The `wifi_ap_config_t` contains:

- `ssid` – The WiFi ssid name upon which we will listen for connecting stations.
- `ssid_len` – The length in bytes of the ssid if not NULL terminated.
- `password` – The password used for station authentication.
- `channel` – The channel we will use for networking.
- `authmode` – How we wish stations to authenticate (if at all). The choices are
  - `open` – No password required
  - `wep`
  - `wpa`
  - `wpa2`
  - `wpa_wpa2`
- `ssid_hidden` – Should we broadcast our ssid.
- `max_connection` – The number of concurrent stations. The default and maximum is 4.
- `beacon_interval` – Unknown. 100.

An example of initialization of this structure might be:

```
wifi_config_t apConfig = {
    .ap = {
        .ssid="<access point name>",
        .ssid_len=0,
        .password="<password>",
        .channel=0,
        .authmode=WIFI_AUTH_OPEN,
        .ssid_hidden=0,
        .max_connection=4,
        .beacon_interval=100
    }
};
```

With the structure populated, we call `esp_wifi_set_config()` ... for example:

```
esp_wifi_set_config(WIFI_IF_AP, &apConfig);
```

Finally, we call `esp_wifi_start()`.

Here is a snippet of code that can be used to setup and ESP32 as an access point:

When we become an access point, an ESP32 WiFi event is produced of type `SYSTEM_EVENT_AP_START`. Note that there is no payload data associated with this event.

Once the ESP32 starts listening for station connects by being an access point, we are going to want to validate that this works. You can use any device or system to scan and connect. Personally, I use a Raspberry PI 3 for testing as it provides a nice Linux environment and has a WiFi adapter build in. You can also choose to plug in a separate WiFi dongle into one of the extra USB ports. One of the first tools we want to run is called "iwlist" which will perform a scan for us:

```
$ sudo iwlist wlan1 scan
```

In the results, we can look for our ESP32 ... for example:

```
Cell 02 - Address: 18:FE:34:6A:94:EF
    ESSID:"ESP32"
    Protocol:IEEE 802.11bgn
    Mode:Master
    Frequency:2.412 GHz (Channel 1)
    Encryption key:off
    Bit Rates:150 Mb/s
    Quality=100/100 Signal level=100/100
```

One of the other tools available on that environment is called "wpa\_cli" which provides a wealth of options for testing WiFi. The recipe I use is to connect to an access point from the command line is:

```
$ sudo wpa_cli
add_network
set_network <num> ssid "<SSID>"
set_network <num> key_mgmt NONE
```

```
enable_network <num>
status
```

## You may have to run

```
select_network <num>
reconnect
```

or

```
reassociate
```

to connect to the target and you can run

```
disconnect
```

to disconnect from the access point.

```
ifname – show current interface
```

```
interface <name> - select current interface
```

To perform a scan run the command "scan". When complete, run "scan\_results" to see the list.

When a station connects, the ESP32 will raise the `SYSTEM_EVENT_AP_STACONNECTED` event. When a station disconnects, we will see the `SYSTEM_EVENT_AP_DISCONNECTED` event.

See also:

- [man\(8\) – wpa\\_cli](#)

When a remote station connects to the ESP32 as an access point, we will see a debug message written to UART1 that may look similar to:

```
station: f0:25:b7:ff:12:c5 join, AID = 1
```

This contains the MAC address of the new station joining the network. When the station disconnects, we will see a corresponding debug log message that may be:

```
station: f0:25:b7:ff:12:c5 leave, AID = 1
```

From within the ESP32, we can determine how many stations are currently connected with a call to `wifi_softap_get_station_num()`. If we wish to find the details of those stations, we can call `wifi_softap_get_station_info()` which will return a linked list of `wifi_sta_list_t`. We have to explicitly release the storage allocated by this call with an invocation of `wifi_softap_free_station_info()`.

Here is an example of a snippet of code that lists the details of the connected stations:

```
uint8 stationCount = wifi_softap_get_station_num();
os_printf("stationCount = %d\n", stationCount);
```

```
wifi_sta_list_t *stationInfo = wifi_softap_get_station_info();
if (stationInfo != NULL) {
    while (stationInfo != NULL) {
        os_printf("Station IP: %d.%d.%d.%d\n", IP2STR(&(stationInfo->ip)));
        stationInfo = STAILQ_NEXT(stationInfo, next);
    }
    wifi_softap_free_station_info();
}
```

When an ESP32 acts as an access point, this allows other devices to connect to it and form a WiFi connection. However, it appears that two devices connected to the same ESP32 acting as an access point can not directly communicate between each other. For example, imagine two devices connecting to an ESP32 as an access point. They may be allocated the IP addresses 192.168.4.2 and 192.168.4.3. We might imagine that 192.168.4.2 could ping 192.168.4.3 and visa versa but that is not allowed. It appears that the only direct network connection permitted is between the newly connected stations and the access point (the ESP32) itself.

This seems to limit the applicability of the ESP32 as an access point. The primary intent of the ESP32 as an access point is to allow mobile devices (eg. your phone) to connect to the ESP32 and have a conversation with an application that runs upon it.

See also:

- `esp_wifi_set_config`
- `esp_wifi_set_mode`

## Working with connected stations

When our ESP32 is being an access point, we are saying that we wish to allow stations to connect to it. This brings in the story of managing those stations. Common things we might want to do are:

- Determine when a new station connects
- Determine when a previously connected station leaves
- List the currently connected stations
- Disconnect one or more currently connected stations

We can register an event handler for detecting new station connects and existing station disconnects. The event handler will receive `SYSTEM_EVENT_AP_STACONNECTED` when a station connects and `SYSTEM_EVENT_AP_STADISCONNECTED` when a station leaves.

We can get the list of currently connected stations using the `esp_wifi_get_station_list()` function. This returns a linked list of stations. The

storage for this list is allocated for us and we should indicate that we are no longer in need of it by calling `esp_wifi_free_station_list()` when done.

See also:

- Handling WiFi events
- `esp_wifi_free_station_list`
- `esp_wifi_get_station_list`

## WiFi at boot time

The ESP32 can store WiFi start-up information in flash memory. This allows it to perform its functions at start-up without having to ask the user for any special or additional information. This capability is controlled by a function called `esp_wifi_set_auto_connect()` and its partner called `esp_wifi_get_auto_connect()`. The values of the settings used for an auto connect are those that are saved in flash memory. These are the values set when we call `esp_wifi_set_config()` but **only** if we have instructed the ESP32 to record those settings to flash. This is itself controlled by a call to `esp_wifi_set_storage()`.

See also:

- `esp_wifi_set_auto_connect`
- `esp_wifi_get_auto_connect`
- `esp_wifi_set_storage`

## The DHCP client

When the ESP32 connects to an access point as a station, it also runs a DHCP client to connect to the DHCP server that it assumes is also available at the access point. From there, the station is supplied its IP address, gateway address and netmask. There are times however when we want to supply our own values for this data. We can do this by calling `tcpip_adapter_set_ip_info()` during setup. The recipe is as follows:

```
tcpip_adapter_init();
tcpip_adapter_dhcpc_stop();
tcpip_adapter_set_ip_info();
esp_wifi_init();
esp_wifi_set_mode();
esp_wifi_set_config();
esp_wifi_start();
esp_wifi_config();
```

(Note that the parameters are omitted in the above).

The setup for calling `tcpip_adapter_set_ip_info()` can be as follows:

```
tcpip_adapter_ip_info_t ipInfo;
IP4_ADDR(&ipInfo.ip, 192,168,1,99);
IP4_ADDR(&ipInfo.gw, 192,168,1,1);
IP4_ADDR(&ipInfo.netmask, 255,255,255,0);
tcpip_adapter_set_ip_info(TCPIP_ADAPTER_IF_STA, &ipInfo);
```

Alternative, using strings we have:

```
tcpip_adapter_ip_info_t ipInfo;
inet_pton(AF_INET, "192.168.1.99", &ipInfo.ip);
inet_pton(AF_INET, "192.168.1.1", &ipInfo.gw);
inet_pton(AF_INET, "255.255.255.0", &ipInfo.netmask);
tcpip_adapter_set_ip_info(TCPIP_ADAPTER_IF_STA, &ipInfo);
```

See also:

- `tcpip_adapter_set_ip_info`
- `tcpip_adapter_dhcpc_start`
- `tcpip_adapter_dhcpc_stop`
- `tcpip_adapter_dhcpc_get_status`
- `tcpip_adapter_dhcpc_option`
- `inet_pton`

## The DHCP server

When the ESP32 is performing the role of an access point, it is likely that you will want it to also behave as a DHCP server so that connecting stations will be able to be automatically assigned IP addresses and learn their subnet masks and gateways.

The DHCP server can be started and stopped within the device using the APIs called `wifi_softap_dhcps_start()` and `wifi_softap_dhcps_stop()`. The current status (started or stopped) of the DHCP server can be found with a call to `wifi_softap_dhcps_status()`.

The default range of IP addresses offered by the DHCP server is 192.168.4.1 upwards. The first address becomes assigned to the ESP32 itself. It is important to realize that this address range is **not** the same address range as your LAN where you may be working. The ESP32 has formed its own network address space and even though they may appear with the same sorts of numbers (192.168.x.x) they are isolated and independent networks. If you start an access point on the ESP32 and connect to it from your phone, don't be surprised when you try and ping it from your Internet connected PC and don't get a response.

See also:

- `tcpip_adapter_dhcps_start`
- `tcpip_adapter_dhcps_stop`
- `tcpip_adapter_dhcps_option`
- `tcpip_adapter_dhcps_get_status`



## Current IP Address, netmask and gateway

Should we need it, we can query the environment for the current IP address, netmask and gateway. The values of these are commonly set for us by a DHCP server when we connect to an access point. The function called `tcpip_adapter_get_ip_info()` returns our current values. Since the ESP32 can have two IP interfaces (one for an access point and one for a station), we supply which interface we wish to retrieve.

When we connect to an access point and have chosen to use DHCP, when we are allocated an IP address, an event is generated that can be used as an indication that we now have a valid IP address.

See also:

- Handling WiFi events
- `tcpip_adapter_get_ip_info`

## WiFi Protected Setup - WPS

The ESP8266 supports WiFi Protected Setup in station mode. This means that if the access point supports it, the ESP8266 can connect to the access point without presenting a password. Currently only the "push button mode" of connection is implemented. Using this mechanism, a physical button is pressed on the access point and, for a period of two minutes, any station in range can join the network using the WPS protocols. An example of use would be the access point WPS button being pressed and then the ESP8266 device calling `wifi_wps_enable()` and then `wifi_wps_start()`. The ESP8266 would then connect to the network.

See also:

- `wifi_wps_enable`
- `wifi_wps_start`
- `wifi_set_wps_cb`
- [Simple Questions: What is WPS \(WiFi Protected Setup\)](#)
- Wikipedia: [WiFi Protected Setup](#)

## Designs for bootstrapping WiFi

Imagine that we have built a project using an ESP32 that wishes to be network connected. In order for that to happen, we want the ESP32 to connect to an existing access point. That's works, because the ESP32 can be a WiFi station. In order for the ESP32 to connect to an access point, it needs to know two important items. It needs to know which network to join (the SSID) and it will need to know the password to use to connect to that network as most networks require authentication. And there is the puzzle. If the ESP32 is brought to a physically new environment, how will it "know"

which network to connect with and what password to use? We should assume that the ESP32 doesn't have a screen attached to it. If it did, we could prompt the user for the information.

One solution is to have the ESP32 initially "be" an access point. If it were an access point then we could use our phone to connect with it, ask it what WiFi networks it can see, provide a password for the network and allow it to connect.

```
while (not done) {
  if (we know our ssid and password) {
    attempt to connect to the access point;
    if (we succeeded in the connection) {
      return;
    }
  }
  become an access point ourselves;
  listen for incoming browser requests;
  wait for an SSID/password pair to be entered;
}
```

We also need to handle the case where we think we have an SSID and password used to connect to an access point but either those have changed or else we are in a foreign location. In that case we must also fall back to being an access point and await new instructions.

We can use non-volatile storage to save our SSID and password. We may wish to save not just one SSID/password pair but perhaps save an ordered list. That way when we teach our device how to connect to an access point and then later teach it how to connect to another one, we might end up back at the first. For example, imagine using an ESP32 at home with one network and the same ESP32 at work with a different network.

We may also want to save static interface information if we either don't have or don't want to use the services of a DHCP server when we start as a station.

See also:

- [Non Volatile Storage](#)

## Tools for WiFi on Linux

Assuming you have a WiFi adapter installed, we need to find its name using `ifconfig`.

`ifconfig`

`iwconfig`

`iwlist`

This command has a lot of subcommands including

```
$ iwlist <if> scanning
```

```
iw
```

```
Show the link informaton
```

```
$ iw dev <dev> link
```

```
To disconnect
```

```
# iw dev <dev> disconnect
```

```
To connect
```

```
# iw dev <dev> connect <SSID>
```

```
wifi_camera_84a0050673dc
```

```
wlx0013ef803dbd
```

## Working with TCP/IP

TCP/IP is the network protocol that is used on the Internet. It is the protocol that the ESP32 natively understands and uses with WiFi as the transport. Books upon books have already been written about TCP/IP and our goal is not to attempt to reproduce a detailed discussion of how it works, however, there are some concepts that we will try and capture.

First, there is the IP address. This is a 32bit value and should be unique to every device connected to the Internet. A 32bit value can be thought of as four distinct 8bit values ( $4 \times 8=32$ ). Since we can represent an 8bit number as a decimal value between 0 and 255, we commonly represent IP addresses with the notation `<number>.<number>.<number>.<number>` for example 173.194.64.102. These IP addresses are not commonly entered in applications. Instead a textual name is typed such as "google.com" ... but don't be misled, these names are an illusion at the TCP/IP level. All work is performed with 32bit IP addresses. There is a mapping system that takes a name (such as "google.com") and retrieves its corresponding IP address. The technology that does this is called the "Domain Name System" or DNS.

When we think of TCP/IP, there are actually three distinct protocols at play here. The first is IP (Internet Protocol). This is the underlying transport layer datagram passing protocol. Above the IP layer is TCP (Transmission Control Protocol) which provides the illusion of a connection over the connectionless IP protocol. Finally there is UDP (User Datagram Protocol). This too lives above the IP protocol and provides datagram (connectionless) transmission between applications. When we say TCP/IP, we are **not**

just talking about TCP running over IP but are in fact using this as a shorthand for the core protocols which are IP, TCP and UDP and additional related application level protocols such as DNS, HTTP, FTP, Telnet and more.

## **The Lightweight IP Stack - lwip**

If we think of TCP/IP as a protocol then we can break up our understanding of networking into two distinct layers. One is the hardware layer that is responsible for getting a stream of 1's and 0's from one place to another. Common implementations for that include Ethernet, Token Ring and (yes ... I'm dating myself now ... dial-up modems). These are characterized by physical wires from your devices. WiFi is itself a transport layer. It deals with using radio waves as the communication medium of 1's and 0's between two points. The specification for WiFi is IEEE 802.11.

Once we can transmit and receive data, the next level is organizing the data over that physical network and this is where TCP/IP comes into play. It provides the rules and governance of data transmission, addressing, routing, protocol negotiations and more. Typically, TCP/IP is implemented in software over the underlying physical transport mechanism. Think about this a moment. Imagine I said to you that I have a "magic box" and if you put something in that box, it will magically be transported to a different box. That is the analogy of physical transport. The software that is TCP/IP adds mechanisms above that. For example, imagine the box is only 6 inches wide. If you want to send me something through our boxes, you have to chop it up and send it in pieces. Your end of the box story handles that. My box will receive the parts and re-assemble them for me. Parts may arrive in order and some parts may even get lost on route and have to be re-sent from the originals. The hardware (the boxes) have no idea how to achieve that. All they know is a piece of data in one end will hopefully arrive at the other ... but not guaranteed.

TCP/IP is a big protocol. It contains lots of parts. Fortunately it is well specified and has been implemented by many vendors over the last 45 years. Some of the implementations of the whole stack of TCP/IP parts have been written as open source and are distributed and maintained by the community. What this means is that if one has a new hardware layer, one can (in principle) lift an already written implementation of TCP/IP, map it to your hardware, compile it for your environment and you are good to go. This is actually much easier said than done ... and fortunately for us, our friends at Espressif have done the work for us.

One such open source implementation of a TCP/IP stack is called "The LightweightIPStack" which is commonly referred to as "lwIP". This can be read about in detail at its home page (see the references). As part of the distribution of the ESP-IDF,

we have libraries that provide an implementation lwIP. It is lwIP that provides the ESP32 the following services:

- IP
- ICMP
- IGMP
- MLD
- ND
- UDP
- TCP
- sockets API
- DNS

Again, the good news is that the vast majority of lwIP is of no importance to us, ESP32 application designers and developers. It is vitally important ... but important to the internal operation of ESP32 and not exposed to us as consumers.

See also:

- [lwIP 2.0.x](#)

## TCP

A TCP connection is a bi-directional pipe through which data can flow in both directions. Before the connection is established, one side is acting as a server. It is passively listening for incoming connection requests. It will simply sit there for as long as needed until a connection request arrives. The other side of the connection is responsible for initiating the connection and it actively asks for a connection to be formed. Once the connection has been constructed, both sides can send and receive data. In order for the "client" to request a connection, it must know the address information on which the server is listening. This address is composed of two distinct parts. The first part is the IP address of the server and the second part is the "port number" for the specific listener. If we think about a PC, you may have many applications running on it, each of which can receive an incoming connection. Just knowing the IP address of your PC is not sufficient to address a connection to the correct application. The combination of IP address plus port number provides all the addressing necessary.

As an analogy to this, think of your cell phone. It is passively sitting there until someone calls it. In our story your phone is the listener. The address that someone uses to form

a connection is your phone number which is comprised of an area code plus the remainder. For example, a phone number of (817) 555-1234 will reach a particular phone. However the area code of 817 is for Fort Worth in Texas ... calling that by itself is not sufficient to reach an individual ... the full phone number is required.

Now we will look at how an ESP32 can set itself up as a listener for an incoming TCP/IP connection and this requires that we begin to understand the important "sockets" API.

## TCP/IP Sockets

The sockets API is a programming interface for working with TCP/IP networking. It is probably the most familiar API for network programming. Sockets programming is familiar to programmers on Linux, Windows, Java and more.

TCP/IP network flows come in two flavors ... connection oriented over TCP and datagram oriented over UDP. The sockets API provides distinct patterns of calls for both styles.

For TCP, a server is built by:

1. Creating a TCP socket
2. Associating a local port with the socket
3. Setting the socket to listen mode
4. Accepting a new connection from a client
5. Receive and send data
6. Close the client/server connection
7. Going back to step 4

For a TCP client, we build by:

1. Creating a TCP socket
2. Connecting to the TCP server
3. Sending data/receiving data
4. Close the connection

Now let us break these up into code fragments that we can analyze in more depth. The header definitions for the sockets API can be found in `<lwip/sockets.h>`.

For both the client and the server applications, the task of creating a socket is the same. It is an API call to the `socket()` function.

```
int sock = socket(AF_INET, SOCK_STREAM, IPPROTO_TCP)
```

The return from `socket()` is an integer handle that is used to refer to the socket. Sockets have lots of state associated with them, however that state is internal to the TCP/IP and sockets implementation and need not be exposed to the network programmer. As such, there is no need to expose that data to the programmer. We can think of calling `socket()` as asking the run-time to create and initialize all the data necessary for a network communication. That data is owned by the run-time and we are passed a "reference number" or handle that acts as a proxy to the data. When ever we wish to subsequently perform work on that network connection, we pass back in that handle that was previously issued to us and we can correlate back to the connection. This isolates and insulates the programmer from the guts of the implementation of TCP/IP and leaves us with a useful abstraction.

When we are creating a server side socket, we want it to listen for incoming connection requests. To do this, we need to tell the socket which TCP/IP port number it should be listening upon. Note that we don't supply the port number directly from an int/short value. Instead we supply the value as returned by the `htons()` function. What this function does is convert the number into what is called "network byte order". This is the byte order that has been chosen by convention to be that used for transmitting unsigned multi byte binary data over the internet. It's actual format is "big endian" which means that if we take a number such as 9876 (decimal) then it is represented in binary as 00100110 10010100 or 0x26D4 in hex. For network byte order, we first transmit 00100110 (0x26) followed by 10010100 (0xD4). It is important to realize that the ESP32 is a **little endian** native architecture which means that we absolutely **must** transform 2 byte and 4 byte numbers into network byte order (big endian).

On a given device, only one application at a time can be using any given local port number. If we want to associate a port number with an application, such as our server application in this case, we perform a task called "binding" which binds (or assigns) the port number to the socket which in turn is owned by the application.

```
struct sockaddr_in serverAddress;
serverAddress.sin_family = AF_INET;
serverAddress.sin_addr.s_addr = htonl(INADDR_ANY);
serverAddress.sin_port = htons(portNumber);
bind(sock, (struct sockaddr *)&serverAddress, sizeof(serverAddress));
```

Notice that we also specify an IP address (in the above example `INADDR_ANY`). This may seem strange as we are defining a socket endpoint and not connecting to any external server. The IP address is the interface at the *local* server that we will accept incoming

connections upon. The special address (`INADDR_ANY` or `0.0.0.0`) means that we will accept connections on all IP interfaces. This becomes especially useful in our ESP32 environment. If we imagine an ESP32 that is being both a station and an access point, we may only wish to accept connections on a given port to *one* of these interfaces. In this case we would supply the IP address of the desired interface.

With the socket now associated with a local port number, we can request that the run-time start listening for incoming connections. We do this by calling the `listen()` API. Before calling `listen()`, connections from clients would have been rejected with an indication to the client that there was nothing at the corresponding target address. Once we call `listen()`, the server will start accepting incoming client connections. The API looks like:

```
listen(sock, backlog)
```

The backlog is the number of connection requests that the run-time will listen for and accept before they are handed off to the application for processing. The way to think about this is imagine that you are the application and you can only do one thing at a time. For example, you can only be talking to one person at a time on the phone. Now imagine you have a secretary who is handling your incoming calls. When a call arrives and you are not busy, the secretary hands off the call to you. Now imagine that you are busy. At that time, the secretary answers the phone and asks the caller to wait. When you free up, she hands you the waiting call. Now let us assume that you are still busy when yet another client calls. She also tells this caller to wait. We are starting to build a queue of callers. And this is where the backlog concept comes into play. The backlog instructs the run-time how many calls can be received and asked to wait. If more calls arrive than our backlog will allow, the run-time rejects the call immediately. Not only does this prevent run-away resource consumption at the server, it also can be used as an indication to the caller that it may be better served trying elsewhere.

Now from a server perspective, we are about ready to do some work. A server application can now block waiting for incoming client connections. The thinking is that a server application's purpose in life is to handle client requests and when it doesn't have an active client request, there isn't anything for it to do but wait for a request to arrive. While that is certainly one model, it isn't necessarily the only model or even the best model (in all cases). Normally we like our processors to be "utilized". Utilized means that while it has productive work it can do, then it should do it. If the only thing our program can do is service client calls, then the original model makes sense. However, there are certain programs that if they don't have a client request to immediately service, might spend time doing something else that is useful. We will come back to that notion later on. For now, we will look at the `accept()` function call. When `accept()` is called, one of two things will happen. If there is no client connection immediately



waiting for us, then we will block until such time in the future when a client connection does arrive. At that time we will wake up and be handed the connection to the newly arrived client. If on the other hand we called `accept()` and there was already a client connection waiting for us, we will immediately be handed that connection and we carry on. In both cases, we call `accept()` and are returned a connection to a client. The distinction between the cases is whether or not we have to wait for a connection to arrive.

The API call looks like:

```
struct sockaddr_in clientAddress;
socklen_t clientAddressLength = sizeof(clientAddress);
int clientSock = accept(sock, (struct sockaddr *)&clientAddress,
&clientAddressLength);
```

The return from `accept()` is a new socket (an integer handle) that represents the connection between the requesting client and the server. It is vital to realize that this is distinct from the server socket we created earlier which we bound to our server listening port. That socket is still alive and well and exists to continue to service further client connections. The newly returned socket is the connection for the conversation that was initiated by this single client. Like all TCP connections, the conversation is symmetric and bi-directional. This means that there is now no longer the notion of a client and server ... both parties can send and receive as they would like at any time.

If we wish to create a socket client, the story is similar. Again we create a `socket()` but this time there is no need for a `bind()/listen()/accept()` story. Instead we use the `connect()` API to connect to the target TCP/IP endpoint.

For example:

```
struct sockaddr_in serverAddress;
serverAddress.sin_family = AF_INET;
inet_pton(AF_INET, "192.168.1.200", &serverAddress.sin_addr.s_addr);
serverAddress.sin_port = htons(9999);

int rc = connect(sock, (struct sockaddr *)&serverAddress, sizeof(struct sockaddr_in));
```

See also:

- Native byte order, endian and network byte order
- `socket`
- `bind`
- `listen`
- `accept`
- `send`
- `recv`
- `connect`

- [Wikipedia – Berkeley Sockets](#)
- [Beej's Guide to Network Programming](#)

## Handling errors

Most of the sockets APIs return an int return code. If this code is < 0 then an error has occurred.

The nature of the error can be found using the global int called "errno". However, in a multitasking environment, working with global variables is not recommended. In the sockets area, we can ask a socket for the last error it encountered using the following code fragment:

```
int esp_x_last_socket_errno(int socket) {
    int ret = 0;
    u32_t optlen = sizeof(ret);
    getsockopt(socket, SOL_SOCKET, SO_ERROR, &ret, &optlen);
    return ret;
}
```

The meanings of the errors can be compared against constants. Here is a table of constants used in the current FreeRTOS implementation:

Symbol	Value	Description
EPERM	1	Operation not permitted
ENOENT	2	No such file or directory
ESRCH	3	No such process
EINTR	4	Interrupted system call
EIO	5	I/O error
ENXIO	6	No such device or address
E2BIG	7	Arg list too long
ENOEXEC	8	Exec format error
EBADF	9	Bad file number
ECHILD	10	No child processes
EAGAIN	11	Try again
ENOMEM	12	Out of memory
EACCES	13	Permission denied
EFAULT	14	Bad address
ENOTBLK	15	Block device required
EBUSY	16	Device or resource busy
EEXIST	17	File exists
EXDEV	18	Cross-device link
ENODEV	19	No such device

ENOTDIR	20	Not a directory
EISDIR	21	Is a directory
EINVAL	22	Invalid argument
ENFILE	23	File table overflow
EMFILE	24	Too many open files
ENOTTY	25	Not a typewriter
ETXTBSY	26	Text file busy
EFBIG	27	File too large
ENOSPC	28	No space left on device
ESPIPE	29	Illegal seek
EROFS	30	Read-only file system
EMLINK	31	Too many links
EPIPE	32	Broken pipe
EDOM	33	Math argument out of domain of func
ERANGE	34	Math result not representable
EDEADLK	35	Resource deadlock would occur
ENAMETOOLONG	36	File name too long
ENOLCK	37	No record locks available
ENOSYS	38	Function not implemented
ENOTEMPTY	39	Directory not empty
ELOOP	40	Too many symbolic links encountered
EWouldBlock EAGAIN	41	Operation would block
ENOMSG	42	No message of desired type
EIDRM	43	Identifier removed
ECHRNG	44	Channel number out of range
EL2NSYNC	45	Level 2 not synchronized
EL3HLT	46	Level 3 halted
EL3RST	47	Level 3 reset
ELNRNG	48	Link number out of range
EUNATCH	49	Protocol driver not attached
ENOCCSI	50	No CSI structure available
EL2HLT	51	Level 2 halted
EBADE	52	Invalid exchange
EBADR	53	Invalid request descriptor
EXFULL	54	Exchange full
ENOANO	55	No anode

EBADRQC	56	Invalid request code
EBADSLT	57	Invalid slot
EBFONT	59	Bad font file format
ENOSTR	60	Device not a stream
ENODATA	61	No data available
ETIME	62	Timer expired
ENOSR	63	Out of streams resources
ENONET	64	Machine is not on the network
ENOPKG	65	Package not installed
EREMOTE	66	Object is remote
ENOLINK	67	Link has been severed
EADV	68	Advertise error
ESRMNT	69	Srmount error
ECOMM	70	Communication error on send
EPROTO	71	Protocol error
EMULTIHOP	72	Multihop attempted
EDOTDOT	73	RFS specific error
EBADMSG	74	Not a data message
E_OVERFLOW	75	Value too large for defined data type
ENOTUNIQU	76	Name not unique on network
EBADFD	77	File descriptor in bad state
EREMCHG	78	Remote address changed
ELIBACC	79	Can not access a needed shared library
ELIBBAD	80	Accessing a corrupted shared library
ELIBSCN	81	.lib section in a.out corrupted
ELIBMAX	82	Attempting to link in too many shared libraries
ELIBEXEC	83	Cannot exec a shared library directly
EILSEQ	84	Illegal byte sequence
ERESTART	85	Interrupted system call should be restarted
ESTRPIPE	86	Streams pipe error
EUSERS	87	Too many users
ENOTSOCK	88	Socket operation on non-socket
EDESTADDRREQ	89	Destination address required
EMSGSIZE	90	Message too long
EPROTOTYPE	91	Protocol wrong type for socket
ENOPROTOOPT	92	Protocol not available
EPROTONOSUPPORT	93	Protocol not supported

ESOCKTNOSUPPORT	94	Socket type not supported
EOPNOTSUPP	95	Operation not supported on transport endpoint
EPFNOSUPPORT	96	Protocol family not supported
EAFNOSUPPORT	97	Address family not supported by protocol
EADDRINUSE	98	Address already in use
EADDRNOTAVAIL	99	Cannot assign requested address
ENETDOWN	100	Network is down
ENETUNREACH	101	Network is unreachable
ENETRESET	102	Network dropped connection because of reset
ECONNABORTED	103	Software caused connection abort
ECONNRESET	104	Connection reset by peer
ENOBUFS	105	No buffer space available
EISCONN	106	Transport endpoint is already connected
ENOTCONN	107	Transport endpoint is not connected
ESHUTDOWN	108	Cannot send after transport endpoint shutdown
ETOOMANYREFS	109	Too many references: cannot splice
ETIMEDOUT	110	Connection timed out
ECONNREFUSED	111	Connection refused
EHOSTDOWN	112	Host is down
EHOSTUNREACH	113	No route to host
EALREADY	114	Operation already in progress
EINPROGRESS	115	Operation now in progress
ESTALE	116	Stale NFS file handle
EUCLEAN	117	Structure needs cleaning
ENOTNAM	118	Not a XENIX named type file
ENAVAIL	119	No XENIX semaphores available
EISNAM	120	Is a named type file
EREMOTEIO	121	Remote I/O error
EDQUOT	122	Quota exceeded
ENOMEDIUM	123	No medium found
EMEDIUMTYPE	124	Wrong medium type

### Configuration settings

Within the "menuconfig" there are some settings that relate to TCP/IP and can be found within the lwIP settings. The settings are:

- **Max number of open sockets – integer** – `CONFIG_LWIP_MAX_SOCKETS` – This is the number of concurrently open sockets. The default is 4 and the maximum appears to be 16.
- **Enable `SO_REUSEADDR` – boolean** – `LWIP_SO_REUSE` – Allow sockets to be re-used without waiting for `TIME_WAIT`.

### Using `select()`

Imagine that we have multiple sockets each of which may be the source of incoming data. If we try and `read()` data from a socket, we normally block until data is ready. If we did this, then if data becomes available on another socket, we wouldn't know. An alternative is to try and read data in a non-blocking fashion. This too would be useful but would require that we test each socket in turn in a busy or polling fashion. This too is not optimal. Ideally what we would like to do is block while watching multiple sockets simultaneously and wake up when the *first* one has something useful for us to do. The `select()` system call provides that capability.

The `select()` function takes 5 parameters:

- The highest file descriptor + 1 to examine
- The set of file descriptors to test for reading
- The set of file descriptors to test for writing
- The set of file descriptors to test for an error
- A timeout after which if nothing has happened to give up

Each of the file descriptor parameters is a bit-mask with the corresponding bit on if we wish to examine that file descriptor. This could be awkward to setup and examine but thankfully a set of macros have been made available that makes it easy.

The parameter of the file descriptor bit mask is of type `fd_set` and we have corresponding macros:

- `FD_ZERO(&fd_set)` – Zero the `fd_set` bitmask.
- `FD_SET(fd, &fd_set)` – Set on the bit corresponding to the file descriptor.
- `FD_ISSET(fd, &fd_set)` – Test if the corresponding file descriptor is on.

The timeout is an instance of a struct `timeval` which has properties of `tv_sec` (seconds) and `tv_usec` (microseconds – Note that this is indeed microseconds and not milliseconds ... a common mistake).

See also:

- `select`
- [The world of `select\(\)`](#)

### Differences from "standard" sockets

Two header files that are commonly found in other sockets implementations are not part of the ESP-IDF definition. They are:

- `netinet/in.h`
- `arpa/inet.h`

Despite not being present, no obvious issues have been found and it is assumed that the content normally contained within has been distributed across other headers.

### UDP/IP Sockets

If we think of TCP as forming a connection between two parties similar to a telephone call, then UDP is like sending a letter through the postal system. If I were to send you a letter, I would need to know your name and address. Your address is needed so that the letter can be delivered to the correct house while your name ensure that it ends up in your hands as opposed to someone else who may live with you. In TCP/IP terms, the address is the IP address and the name is the port number.

With a telephone conversation, we can exchange as much or as little information as we like. Sometimes I talk, sometimes you talk ... but there is no maximum limit on how much information we can exchange in one conversation. With a letter however, there are only so many pages of paper that will fit in the envelopes I have at my disposal.

The notion of the mail analogy is how we might choose to think about UDP. The acronym stands for User Datagram Protocol and it is the notion of the datagram that is akin to the letter. A datagram is an array of bytes that are transmitted from the sender to the receiver as a unit. The maximum size of a datagram using UDP is 64KBytes. No connection need be setup between the two parties before data starts to flow. However, there is a down side. The sender of the data will not be made aware of a receiver's failure to retrieve the data. With TCP, we have handshaking between the two parties that lets the sender know that the data was received and, if not, can automatically re-transmit until it has been received or we decide to give up. With UDP, and just like a letter, when we send a datagram, we lose sight of whether or not it actually arrives safely at the destination.

Now is a good time to come back to IP addresses and port numbers. We should start to be aware that on a PC, only one application can be listening upon any given port. For

example, if my application is listening on port 12345, then no other application can also be listening on that same port ... not your application nor another copy/instance of mine. When an incoming connection or datagram arrives at a machine, it has arrived because the IP address of the sent data matches the IP address of the device at which it arrived. We then route within the device based on port numbers. And here is where I want to clarify a detail. We route within the machine based on the **pair** of both protocol and port number.

So for example, if a request arrives at a machine for port 12345 over a TCP connection, it is routed to the TCP application watching port 12345. If a request arrives at the same machine for port 12345 over UDP, it is routed to the UDP application watching port 12345. What this means is that we **can** have two applications listening on the same port but on different protocols. Putting this more formally, the allocation space for port numbers is a function of the protocol and it is not allowed for two applications to simultaneously reserve the same port within the same protocol allocation space. Although I used the story of a PC running multiple applications, in our ESP32 the story is similar even though we just run one application on the device. If your single application should need to listen on multiple ports, don't try and use the same port with the same protocol as the second function call will find the first one has already allocated the port. This is a detail that I am happy for you to forget as you will rarely come across it but I wanted to catch it here for completeness.

To program with UDP, once again we use sockets. To set up a socket server using UDP again we call `socket()` to create a socket and again we call `bind()` to specify the port number we wish to listen upon. There is no need for a call to `listen()`. When the server is ready to receive an incoming request, we call `recvfrom()` which blocks until a datagram is received. Once one arrives, we wake up and can process the request. The request contains a return address and we can send a response using `sendto()` should we wish.

On the client side, we create a `socket()` and then can invoke `sendto()`. The call to `sendto()` takes the IP address and port of the target as parameters as well as the payload data.

For example:

```
int socket_fd = socket(AF_INET, SOCK_DGRAM, 0);
sendto(socket_fd, data, size, 0, destAddr, destAddrLen);
```

- `socket`
- `sendto`
- `recvfrom`



## TLS, SSL and security

So far we have been thinking about making sockets calls that form a network connection and then sending and receiving data over that connection. However we have a security problem. The data that flows over the wire is not encrypted. This means that if one were to "sniff" or otherwise examine the network data, we would see the content of the data being transmitted. For example, if I send a password used for authentication, if we were to examine the content of the data, we would be able to determine the password I am using.

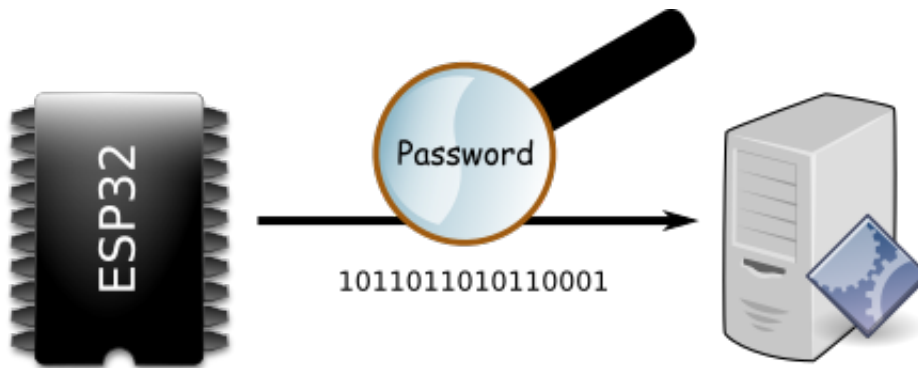

It actually isn't that difficult to sense the data being sent and received. Excellent tools such as Wireshark are used for debugging and can easily be used to examine the content of the network packets or stream. Obviously we are already exchanging credit card data, email and other sensitive information over the Internet so how is that done today?

The answer is a concept called the "Secure Socket Layer" or SSL. SSL provides the capability to encrypt the data before transmission such that only the intended recipient can decrypt it. Conversely, any responses sent by the recipient are also encrypted such that only we can decrypt the data. If someone were to capture or otherwise examine the data being sent over the wire, there is no way for them to get back to the original data content.



The way this works is through the concept of private keys. Imagine I think of a very large random number (and by large I mean VERY large). We call this number my private key. Now imagine that associated with the private key is a corresponding number (the public key) that can be used to decrypt a message that was encoded using the private key. Now imagine I want to correspond with a partner securely. I send a request (unencrypted) to the partner and ask for his public key. He sends that back and I send to him a copy of MY public key encrypted with his public key. Since only a matching pair of public/private keys can be used to decrypt data, only the desired recipient can decrypt the message at which point he will have a copy of my public key. Now in the future I can send him messages encrypted with my private key and further encrypted with his public key and he will be able to decode them with his copy of his private key and my public key while he can send me encrypted messages encoded with his private key which I can decode with my copy of his public key. By having exchanged public keys, we are now good to continue exchanging data without fear that it will be seen by anyone else.

All of this encryption of data happens outside and above the knowledge of TCP/IP networking. TCP/IP provides the delivery of data but cares nothing about its content. As such, and at a high level, if we wish to exchange secure data, we must perform the encryption and decryption using algorithms and libraries that live outside of the sockets API and use sockets as the transport for transmitting and receiving the encrypted data that is fed into and received from the encryption algorithms.

When using mbed TLS, we need a large stack size. I don't yet know how small we can get away with but I have been using 8000 bytes.

When using SSL, the client will initially send the server a request that includes how the handshake is to proceed. Three pieces of information are transmitted:

- key – How the keys are to be exchanged. Choices are:
  - RSA

- Diffie-Hellman
- DSA
- cipher – How encryption is to be performed
  - RC4
  - Triple DES
  - AES
- hash – algorithm
  - HMAC-MD5
  - HMAC-SHA

The client sends all the variations of key, cipher and hash that it supports. The server will then choose from this list which of the key, cipher and hash it has chosen to use. It will also send a server certificate to the client which will include the server's public key.

See also:

- [mbed TLS](#)
- [mbed TLS home page](#)
- [mbed TLS tutorial](#)
- [mbed TLS API reference](#)

## Keys files

Keys files are used to contain public and/or private keys.

### PEM files

A PEM (Privacy Enhanced Mail) file is a base64 encoded DER certificate.

See also:

- [PEM Files](#)

## mbedTLS client app structure

Let us start to break down the structure of a TLS application that uses the mbedTLS APIs.

First there is the notion of a network context that is initialized by a call to

```
MBEDTLS_NET_INIT().
```

```
MBEDTLS_NET_CONTEXT server_fd;  
MBEDTLS_NET_INIT(&server_fd);
```

There is nothing more to explain here. The data that is initialized is "opaque" to us and the invocation of this function is part of the rules.

Next comes the initialization of the SSL context with a call to `MBEDTLS_SSL_INIT()`.

```
MBEDTLS_SSL_CONTEXT ssl;  
MBEDTLS_SSL_INIT(&ssl);
```

Again, there is nothing more to explain here. The data is again opaque and this function merely initializes it for us. Calling this function is also part of the rules.

Now we call `MBEDTLS_SSL_CONFIG_INIT()`.

```
MBEDTLS_SSL_CONFIG config;  
MBEDTLS_SSL_CONFIG_INIT(&config);
```

These initializations repeat for other data types including:

```
MBEDTLS_CTR_DRBG_CONTEXT ctr_drbg;  
MBEDTLS_CTR_DRBG_INIT(&ctr_drbg);  
  
MBEDTLS_ENTROPY_CONTEXT entropy;  
MBEDTLS_ENTROPY_INIT(&entropy);  
  
MBEDTLS_X509_CRT cacert;  
MBEDTLS_X509_CRT_INIT(&cacert);
```

SSL utilizes good random number generators. What is a "good" random number? Since computers are deterministic devices, the generation of a random number is performed through the execution of an algorithm and since algorithms are deterministic, then a sequence of numbers generated by these functions might, in principle, be predictable. A good random number generator is one where the sequence of numbers produced is not at all easily predictable and generates values with no biases towards their values with an equal probability of any number within a range being chosen.

We initialize the random number generator with a call to `MBEDTLS_CTR_DRBG_SEED()`.

Note: We see the phrase "ctr\_drbg" ... that is an acronym for "Counter mode Deterministic Random Byte Generator". It is an industry standard specification/algorithm for generating random numbers.

<http://nvlpubs.nist.gov/nistpubs/SpecialPublications/NIST.SP.800-90Ar1.pdf>

With the setup under our belts, it is now time to start considering SSL based communication. Since we are considering SSL over sockets, if we were not using TLS sockets, we would perform a call to `socket()` to create a socket and then `connect()` to connect to our partner. In the world of `mbedtls`, we call `mbedtls_net_connect()`. This has the form:

```
mbedtls_net_connect(&server_fd, <hostname>, <port>, MBEDTLS_NET_PROTO_TCP);
```

The `hostname` and `port` define where we are connecting to. Notice the first parameter. This is the `mbedtls_net_context` structure that we initialized with a call to `mbedtls_net_init()` previously. We should always check the return code to ensure that the connection was successful.

Now we get to configure our SSL defaults with a call to `mbedtls_ssl_config_defaults()`. For example:

```
mbedtls_ssl_config_defaults(  
    &conf,  
    MBEDTLS_SSL_IS_CLIENT,  
    MBEDTLS_SSL_TRANSPORT_STREAM,  
    MBED_SSL_PRESET_DEFAULT)
```

When we are communicating via SSL, we commonly wish to validate that the credentials provided by our partner indicate that they are who they claim to be. This process is called authentication. We can define what kind of authentication we wish to perform by calling `mbedtls_ssl_conf_authmode()`.

```
mbedtls_ssl_conf_authmode(&ssl, MBEDTLS_SSL_VERIFY_NONE)
```

Earlier we said that SSL is heavily dependent on a good random number generator. Now we tell the environment which random number generator we wish to use:

```
mbedtls_ssl_conf_rng(&ssl, mbedtls_ctr_drbg_random, &ctr_drbg)
```

Next we do some more SSL context setup by calling `mbedtls_ssl_set_hostname()`.

```
mbedtls_ssl_set_hostname(&ssl, "name")
```

Now we instruct the SSL environment which functions to use to send and receive data by calling `mbedtls_ssl_set_bio()`.

```
mbedtls_ssl_set_bio(&ssl, &server_fd, mbedtls_net_send, mbedtls_net_recv, NULL)
```

At this point, we have formed a connection to our partner and configured the SSL environment. What remains is to actually read and write data. To write data we call

```
MBEDTLS_SSL_WRITE(ssl, buf, len)
```

```
MBEDTLS_SSL_WRITE(ssl, buf, len)
```

and to read data we call `MBEDTLS_SSL_READ(ssl, buf, len)`.

```
MBEDTLS_SSL_READ(ssl, buf, len)
```

See also:

- `MBEDTLS_NET_INIT`
- `MBEDTLS_SSL_INIT`
- `MBEDTLS_SSL_CONFIG_INIT`
- `MBEDTLS_NET_CONNECT`
- `MBEDTLS_SSL_CONFIG_DEFAULTS`
- `MBEDTLS_SSL_CONF_AUTHMODE`
- `MBEDTLS_SSL_CONF_RNG`
- `MBEDTLS_SSL_SET_HOSTNAME`
- `MBEDTLS_SSL_SET_BIO`
- `MBEDTLS_SSL_WRITE`
- `MBEDTLS_SSL_READ`

## MBEDTLS client example

Here is a sample function that has been tested on an ESP32 to make an HTTPS call to a remote HTTPS server to retrieve some results.

```
#include <mbdts/platform.h>

#include <mbdts/ctr_drbg.h>
#include <mbdts/debug.h>
#include <mbdts/entropy.h>
#include <mbdts/error.h>
#include <mbdts/net.h>
#include <mbdts/ssl.h>

#include <esp_log.h>
#include <string.h>
#include <stdio.h>

#define SERVER_NAME "httpbin.org"
#define SERVER_PORT "443"
static char tag[] = "callhttps";

static char errortext[256];

static void my_debug(void *ctx, int level, const char *file, int line, const char *str) {
    ((void) level);
    ((void) ctx);
}
```

```

    printf("%s:%04d: %s", file, line, str);
}

void callhttps() {
    ESP_LOGD(tag, "--> callhttps\n");
    mbedtls_net_context server_fd;
    mbedtls_entropy_context entropy;
    mbedtls_ctr_drbg_context ctr_drbg;
    mbedtls_ssl_context ssl;
    mbedtls_ssl_config conf;
    mbedtls_x509_crt cacert;

    int ret;
    int len;
    char *pers = "ssl_client1";
    unsigned char buf[1024];

    mbedtls_net_init(&server_fd);
    mbedtls_ssl_init(&ssl);
    mbedtls_ssl_config_init(&conf);
    mbedtls_x509_crt_init(&cacert);
    mbedtls_ctr_drbg_init(&ctr_drbg);
    mbedtls_entropy_init(&entropy);
    mbedtls_ssl_conf_dbg(&conf, my_debug, stdout);

    mbedtls_debug_set_threshold(2); // Log at error only
    ret = mbedtls_ctr_drbg_seed(
        &ctr_drbg,
        mbedtls_entropy_func, &entropy, (const unsigned char *) pers, strlen(pers));
    if (ret != 0) {
        ESP_LOGE(tag, " failed\n ! mbedtls_ctr_drbg_seed returned %d\n", ret);
        return;
    }

    ret = mbedtls_net_connect(&server_fd, SERVER_NAME, SERVER_PORT, MBEDTLS_NET_PROTO_TCP);
    if (ret != 0) {
        ESP_LOGE(tag, " failed\n ! mbedtls_net_connect returned %d\n\n", ret);
        return;
    }

    ret = mbedtls_ssl_config_defaults(
        &conf,
        MBEDTLS_SSL_IS_CLIENT,
        MBEDTLS_SSL_TRANSPORT_STREAM,
        MBEDTLS_SSL_PRESET_DEFAULT);
    if (ret != 0) {
        ESP_LOGE(tag, " failed\n ! mbedtls_ssl_config_defaults returned %d\n\n", ret);
        return;
    }

    mbedtls_ssl_conf_authmode(&conf, MBEDTLS_SSL_VERIFY_NONE);

    mbedtls_ssl_conf_rng(&conf, mbedtls_ctr_drbg_random, &ctr_drbg);

    ret = mbedtls_ssl_setup(&ssl, &conf);
    if (ret != 0) {
        mbedtls_strerror(ret, errortext, sizeof(errortext));
        ESP_LOGE(tag, "error from mbedtls_ssl_setup: %d - %x - %s\n", ret, ret, errortext);
        return;
    }

    ret = mbedtls_ssl_set_hostname(&ssl, "httpbin.org");
    if (ret != 0) {
        mbedtls_strerror(ret, errortext, sizeof(errortext));
        ESP_LOGE(tag, "error from mbedtls_ssl_set_hostname: %d - %x - %s\n", ret, ret, errortext);
        return;
    }
}

```

```

mbedtls_ssl_set_bio(&ssl, &server_fd, mbedtls_net_send, mbedtls_net_recv, NULL);

char *requestMessage = \
    "GET /ip HTTP/1.1\r\n" \
    "User-Agent: kolban\r\n" \
    "Host: httpbin.org\r\n" \
    "Accept-Language: en-us\r\n" \
    "Accept-Encoding: gzip, deflate\r\n" \
    "\r\n";
sprintf((char *)buf, requestMessage);
len = strlen((char *)buf);

ret = mbedtls_ssl_write(&ssl, buf, len);
if (ret < 0) {
    mbedtls_strerror(ret, errortext, sizeof(errortext));
    ESP_LOGE(tag, "error from write: %d -%x - %s\n", ret, ret, errortext);
    return;
}

len = sizeof(buf);
ret = mbedtls_ssl_read(&ssl, buf, len);
if (ret < 0) {
    ESP_LOGE(tag, "error from read: %d\n", len);
    return;
}

printf("Result:\n%.s\n", len, buf);

mbedtls_net_free(&server_fd);
mbedtls_ssl_free(&ssl);
mbedtls_ssl_config_free(&conf);
mbedtls_ctr_drbg_free(&ctr_drbg);
mbedtls_entropy_free(&entropy);
ESP_LOGV(tag, "All done");
}

```

## Notes:

When debugging MBED in Curl set MBEDTLS\_DEBUG to 1 in `curl_config.h`.

## mbedtls server app structure

We can create a self signed SSL certificate:

`mbedtls_net_init`

`mbedtls_ssl_init`

`mbedtls_ssl_config_init`

`mbedtls_x509_cert_init`

`mbedtls_pk_init`

`mbedtls_entropy_init`

`mbedtls_ctr_drbg_init`

`mbedtls_debug_set_threshold`

`mbedtls_x509_cert_parse`



mbedtls\_pk\_parse\_key  
mbedtls\_net\_bind  
mbedtls\_ctr\_drbg\_seed  
mbedtls\_ssl\_config\_defaults  
mbedtls\_ssl\_conf\_rng  
mbedtls\_ssl\_conf\_dbg  
mbedtls\_ssl\_conf\_session\_cache  
mbedtls\_ssl\_conf\_ca\_chain  
mbedtls\_ssl\_conf\_own\_cert  
mbedtls\_ssl\_setup  
mbedtls\_net\_free  
mbedtls\_ssl\_session\_reset  
mbedtls\_net\_accept  
mbedtls\_ssl\_set\_bio  
mbedtls\_ssl\_handshake  
mbedtls\_ssl\_read  
mbedtls\_ssl\_write  
mbedtls\_ssl\_close\_notify

See also:

- [mbedtls](#)
- [Sample server app](#)

## mbedtls Debugging

The mbedtls library has some rich debugging built in but needs enabled. First we are responsible for writing a function that will log the messages issued. Here is an example function:

```
static void my_debug(  
    void *ctx,  
    int level,  
    const char *file,  
    int line,  
    const char *str) {
```

```

    ((void) level);
    ((void) ctx);
    printf("%s:%04d: %s", file, line, str);
}

```

We use a `printf()` here as the string contains a newline at the end. Once this function is written, it must be registered with the SSL Configuration using:

```

mbedtls_ssl_conf_dbg(&m_conf, my_debug, nullptr);

```

and finally, we must declare at what level we want debugging to proceed. We use the following call to specify this:

```

mbedtls_debug_set_threshold(4);

```

And to conclude, we must enable mbedtls debugging in the `make menuconfig` setting:

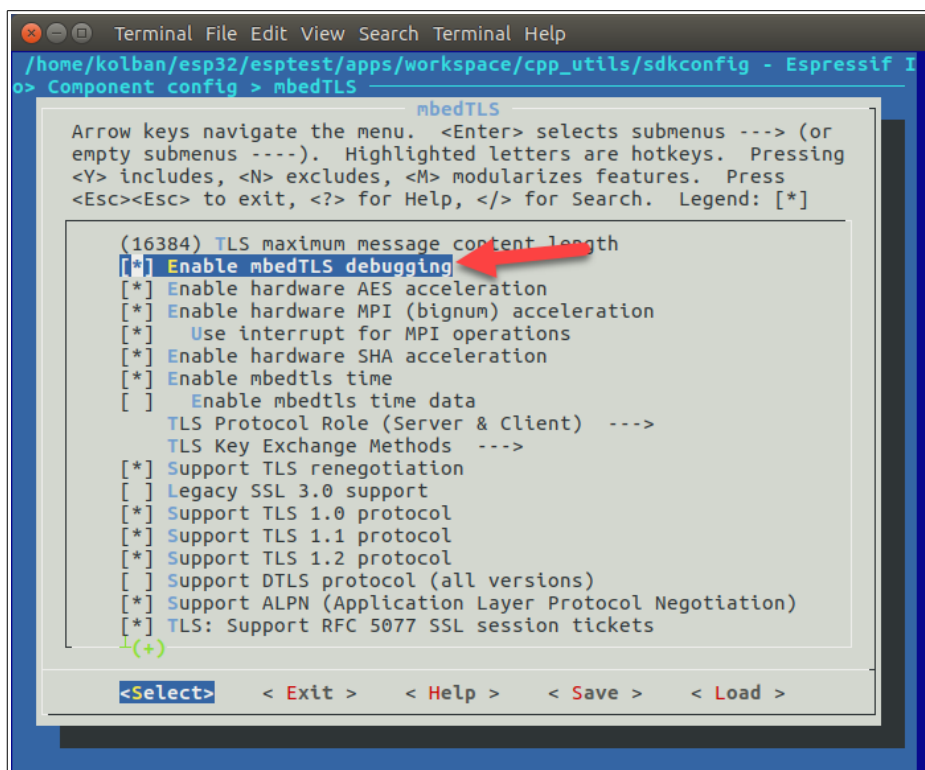

## OpenSSL

OpenSSL is a popular implementation of an SSL stack. In the ESP32 environment, the selected stack for SSL/TLS is mbedTLS which is not the same as OpenSSL. As part of the ESP-IDF, a mapping layer has been provided that exposes the OpenSSL API on top of an mbedTLS implementation.

We can create a private RSA key using:

```

openssl genrsa -out file.txt 1024

```

PEM – a data format that is a base64 string ... commonly:

```
-----BEGIN RSA PRIVATE KEY-----  
MIICXQIBAAKBgQDUpzB+UVRVf7i2bsABojZAKIJKYz0xyDxFgLAzB6P9cuqOmm38  
-----END RSA PRIVATE KEY-----
```

Given a private key, we can generate the public key:

```
openssl rsa -in file.txt -pubout
```

We can convert from PEM to DER or DER to PEM format files.

We can encrypt and decrypt data using rsautl subcommands.

See also:

- [OpenSSL](#)

## RSA encryption/decryption

Using the mbedTLS we can encrypt/decrypt data using public/private keys.

A private key can be encoded in a number of ways. One way is the binary DER format which is an ASN.1 encoding.

We can decode this online using:

<https://lapo.it/asn1js/>

Imagine we have an RSA private key and a piece of data that was encrypted using the corresponding public key. Here is a recipe to de-encrypt the data.

```
mbedtls_pk_context pk_context;  
mbedtls_pk_init(&pk_context);  
int rc = mbedtls_pk_parse_key(&pk_context, private_der, sizeof(private_der), NULL, 0);  
uint8_t oBuf[1024];  
size_t retSize;  
rc = mbedtls_pk_decrypt(  
    &pk_context,  
    encoded_data,  
    encoded_data_length,  
    oBuf,  
    &retSize,  
    sizeof(oBuf),  
    NULL,  
    NULL  
);  
mbedtls_pk_free(&pk_context);
```

See also:

- `mbedtls_pk_parse_key`

- `mbedtls_pk_decrypt`
- `mbedtls_pk_encrypt`
- [mbedtls – RSA functions](#)
- [mbedtls – PK functions](#)
- [mbedtls – Sample applications](#)
- [Github: mbedtls – samples](#)

## Generate DER data containing a private key

```

mbedtls_rsa_context rsa;
mbedtls_entropy_context entropy;
mbedtls_ctr_drbg_context ctr_drbg;
mbedtls_ctr_drbg_init(&ctr_drbg);
mbedtls_entropy_init(&entropy);

mbedtls_ctr_drbg_seed(
    &ctr_drbg,
    mbedtls_entropy_func,
    &entropy,
    (const unsigned char*)pers,
    strlen(pers));
mbedtls_rsa_init(&rsa, MBEDTLS_RSA_PKCS_V15, 0);
mbedtls_rsa_gen_key(&rsa, mbedtls_ctr_drbg_random, &ctr_drbg, 2048, 65537);

```

we can use `mbedtls_pk_write_key_der()` to write the DER file.

See also:

- Error: Reference source not found
- [Github: ARMMbed.mbedtls – gen\\_key.c](#)

## Name Service

On the Internet, server machines can be found by their Domain Name Service (DNS) names. This is the service that resolves a human readable representation of a machine such as "google.com" into the necessary IP address value (eg. 216.58.217.206). In order for this transformation to happen, the ESP32 needs to know the IP address of one or more DNS servers that it will then use to perform the name to IP address mapping. If we are using DHCP then nothing else need be done as the DHCP server automatically provides the DNS server addresses. However, if we should not be using DHCP (for example we are using static IP addresses), then we need to instruct the ESP32 of the locations of the DNS servers manually. We can do this using `dns_setserver()` function. This takes an IP address as input along with which of the two possible DNS servers to use. The ESP32 is configured to know the identity of up to two external name servers. The reason for two is that if an attempt to reach the first one fails, we will utilize the second one. We can retrieve our current DNS server identities using `dns_getserver()`.

Google publicly makes available two name servers with the addresses of 8.8.8.8 and 8.8.4.4.

Once we have defined the name servers, we can look up the address of a host name using the `gethostbyname()` function.

During development, we may wish to test a specific DNS server to validate that it can resolve a host name. An excellent Linux tool to perform this task is "`nslookup`". It has many options but for our purposes, we can supply it the host name to lookup and the DNS server to use:

```
$ nslookup example.com 8.8.8.8
Server:      8.8.8.8
Address:    8.8.8.8#53
```

```
Non-authoritative answer:
Name:   example.com
Address: 93.184.216.34
```

See also:

- `gethostbyname`
- `dns_getserver`
- `dns_setserver`
- Wikipedia: [Domain Name System](#)
- Google: [Public DNS](#)

## Multicast Domain Name Systems

On a local area network with dynamic devices coming and going, we may want one device to find the IP address of another device so that they may interact with each other. The problem though is that IP addresses can be dynamically allocated by a DHCP server running on a WiFi access point. This means that the IP address of a device is likely not going to be static. In addition, it is not a great usability story to refer to devices by their IP addresses. What we need is some form of dynamic name service for finding devices by name where their IP addresses aren't administrator configured. This is where the Multicast Domain Name System (mDNS) comes into play.

At a high level, when a device wishes to find another device with a given name, it broadcasts a request to all members of the network asking for a response from the device that has that name. If a machine believes it has that identity, it responds with its own broadcast which includes its name and IP address. Not only does this satisfy the original request, but other machines on the network can see this interaction and cache the response for themselves. This means that should they need to resolve the same host in the future, they already have the answer.

Using the Multicast Domain Name System (mDNS) an ESP32 can attempt to resolve a host name of a machine on the local network to its IP address. It does this by broadcasting a packet asking for the machine with that identity to respond.

The name service demons are implemented by Bonjour and nss-mdns (Linux).

Normally, hosts located using this technique belong to a domain ending in ".local".

To determine if your PC is participating in mDNS you can examine whether or not it is listening on UDP port 5353. This is the port used for mDNS communications.

See also:

- [Wikipedia – Multicast DNS](#)
- IETF RFC 6762: [Multicast DNS](#)
- [Multicast DNS](#)
- [New DNS Technologies in the Lan](#)
- [Avahi](#) – Implementation of mDNS ... source project for Unix machines
- [Adafruit – Bonjour \(Zeroconf\) Networking for Windows and Linux](#)
- [chrome.mdns](#) – API description for Chrome API for mDNS
- [Android – ZeroConf Browser](#)

### mDNS API programming

The ESP-IDF provides a set of rich APIs for programming mDNS on the ESP32. Specifically, we can either advertise ourselves in mDNS or else query existing mDNS information.

The attributes of an mDNS server entry appear to be:

- hostname – `mdns_set_hostname()`
- default instance – `mdns_set_instance()`
- service – `mdns_service_add()`
  - type – `_http`, `_ftp` etc etc
  - protocol – `_tcp`, `_udp` etc etc
  - port – port number
- instance name for service – `mdns_service_instance_set()`
- TXT data for service – `mdns_service_txt_set()`

See also:

- `mdns_set_hostname`
- `mdns_set_instance`
- `mdns_service_add`
- `mdns_service_instance_set`
- `mdns_service_port_set`

## Installing Bonjour

Launch the Bonjour installer:

Bonjour64

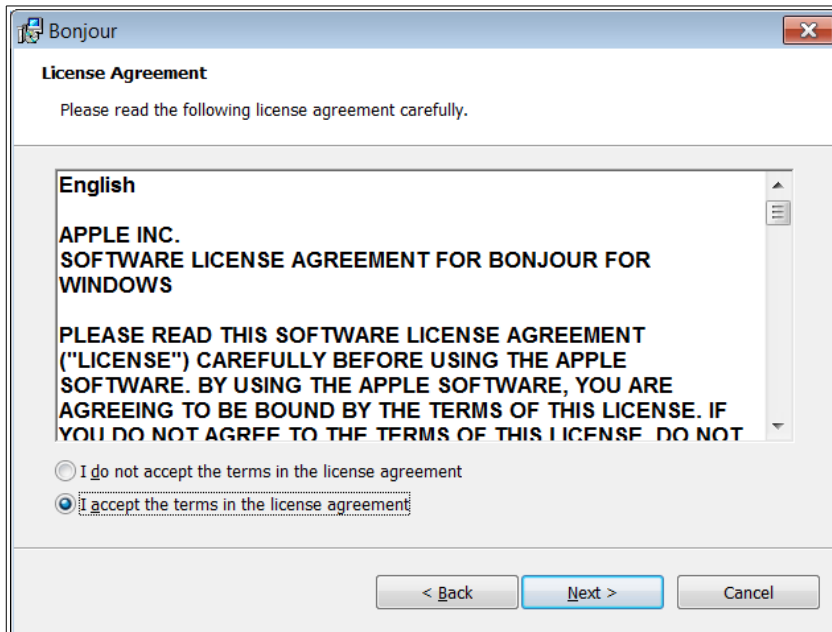
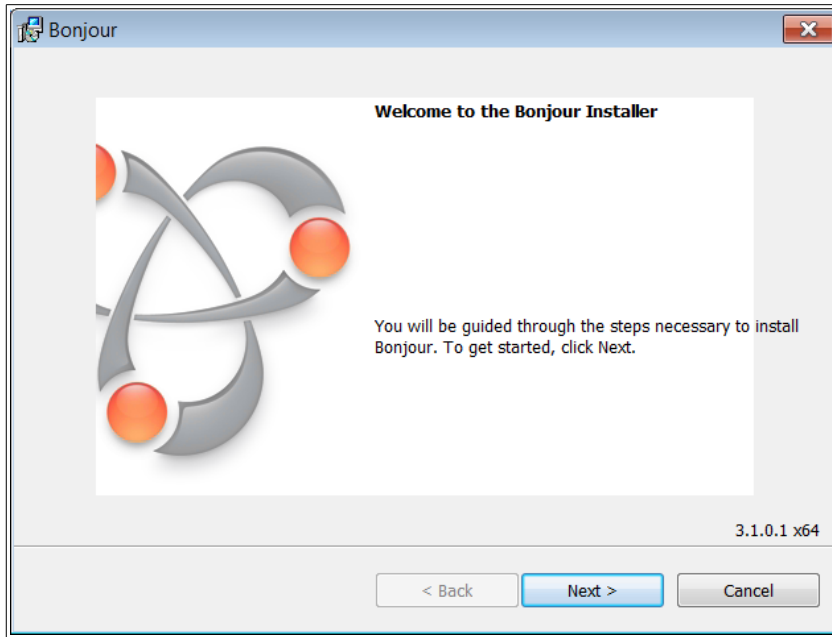

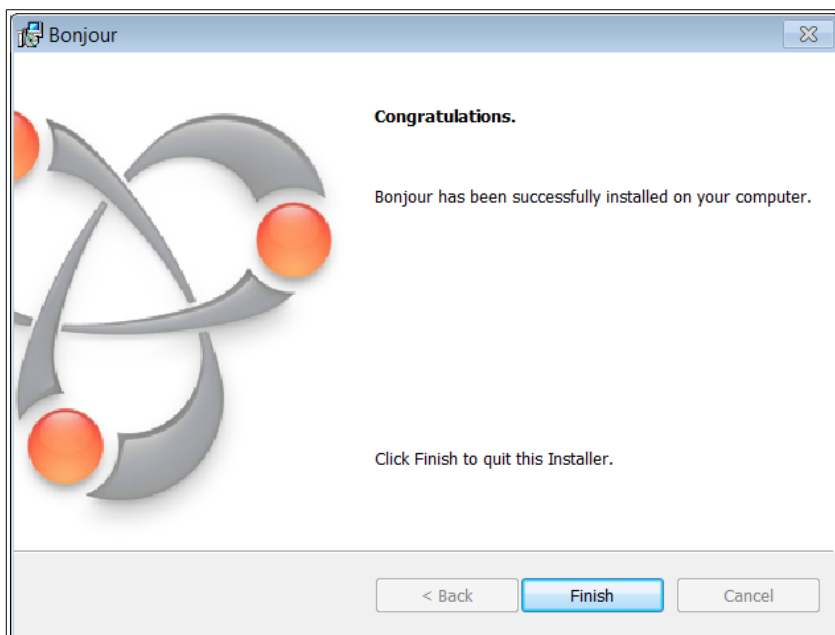
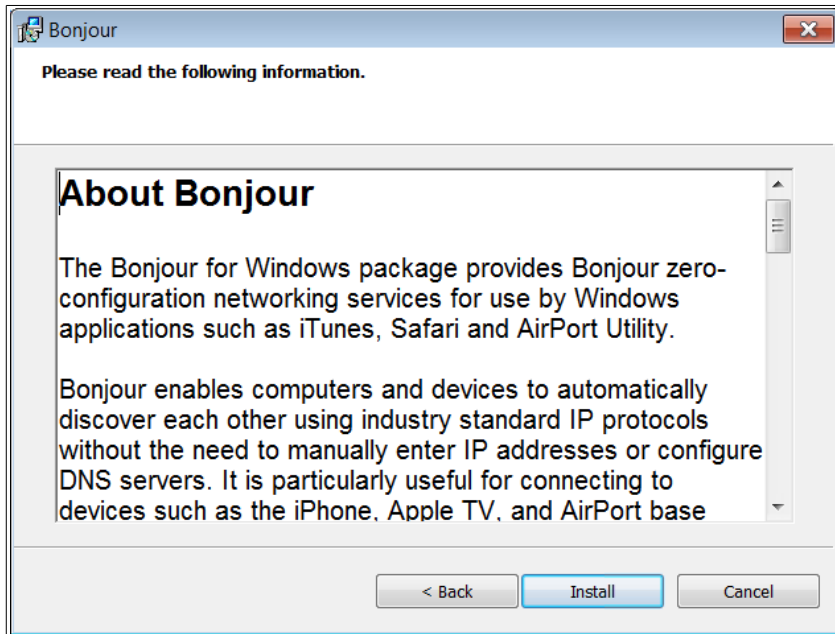

If all has gone well, we will find a new Windows service running called "Bonjour Service":



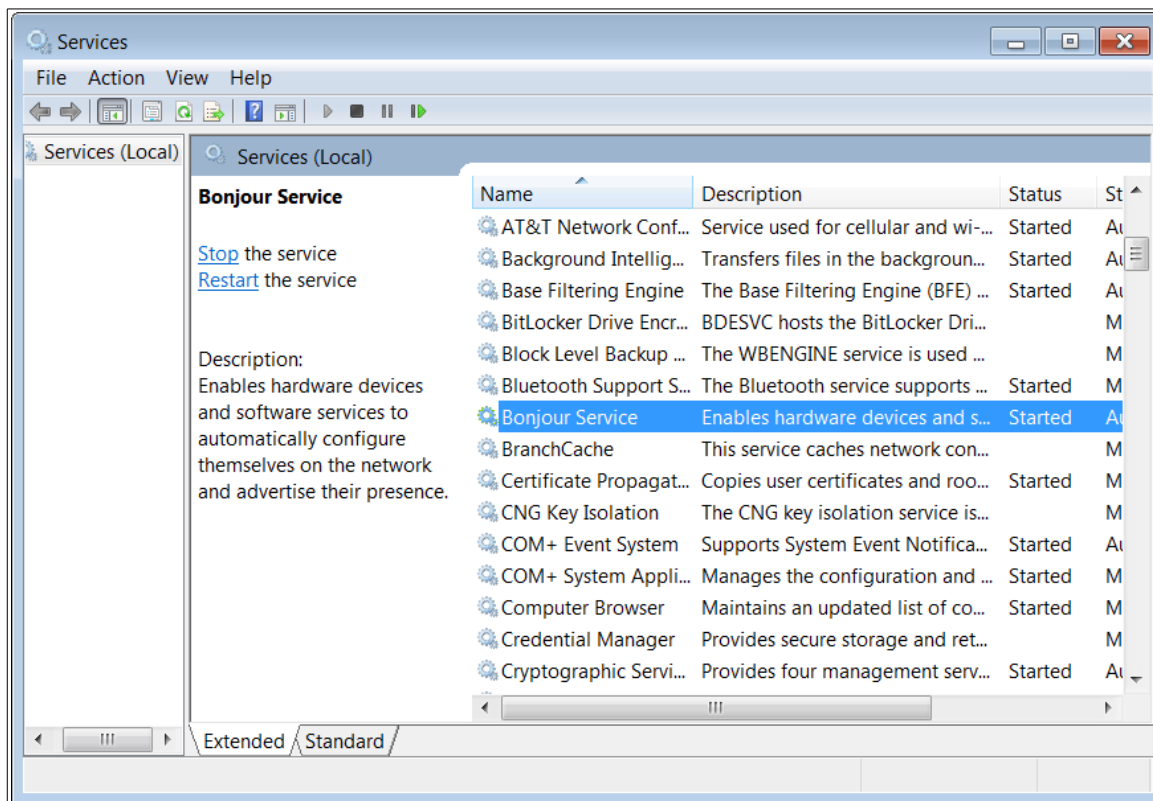

There is also a Bonjour browser available here ...

<http://hobbyistsoftware.com/bonjourbrowser>

## Avahi

An implementation of Multicast DNS on Linux is called Avahi. Avahi runs as the `systemd` daemon called "`avahi-daemon`". We can determine whether or not it is running with:

```
$ systemctl status avahi-daemon
● avahi-daemon.service - Avahi mDNS/DNS-SD Stack
   Loaded: loaded (/lib/systemd/system/avahi-daemon.service; enabled)
   Active: active (running) since Wed 2016-01-20 22:13:35 CST; 1 day 13h ago
 Main PID: 384 (avahi-daemon)
   Status: "avahi-daemon 0.6.31 starting up."
   CGroup: /system.slice/avahi-daemon.service
          └─384 avahi-daemon: running [raspberrypi.local]
             └─426 avahi-daemon: chroot helper
```

The `avahi-daemon` utilizes a configuration file found at `/etc/avahi/avahi-daemon.conf`. The default name that avahi advertizes itself as is the local hostname.

When host-name resolution is performed, the system file called `/etc/nsswitch.conf` is used to determine the order of resolution. Specifically the `hosts` entry contains the name resolution. An example would be:

```
hosts:          files mdns4_minimal [NOTFOUND=return] dns
```

Which says "first look in `/etc/hosts`, then consult mDNS and then use full DNS". What this means is that a device which advertizes itself with mDNS can be found via a lookup of "`<hostname>.local`". For example, if I boot up a Linux machine which gets a dynamic IP address through DHCP and the hostname of that machine is "chip1", then I can reach it with a domain name address of "chip1.local". If the IP address of the device changes, subsequent resolutions of the domain name will continue to correctly resolve.

Avahi tools are not installed by default but can be installed using the "avahi-utils" package:

```
$ sudo apt-get install avahi-utils
```

To see the list of mDNS devices in your network, we can use the `avahi-browse` command. For example:

```
$ avahi-browse -at
+ wlan1 IPv6 chip1 [ce:79:cf:21:db:95]      Workstation      local
+ wlan1 IPv4 chip1 [ce:79:cf:21:db:95]      Workstation      local
+ wlan0 IPv6 pizero [00:36:76:21:97:a3]     Workstation      local
+ wlan0 IPv6 raspi3 [b8:27:eb:9d:fc:60]     Workstation      local
+ wlan0 IPv6 chip1 [cc:79:cf:21:db:95]     Workstation      local
+ wlan0 IPv4 pizero [00:36:76:21:97:a3]     Workstation      local
+ wlan0 IPv4 raspi3 [b8:27:eb:9d:fc:60]     Workstation      local
+ wlan0 IPv4 chip1 [cc:79:cf:21:db:95]     Workstation      local
+ wlan0 IPv6 pizero                        Remote Disk Management
local
+ wlan0 IPv6 raspi3                        Remote Disk Management
local
+ wlan0 IPv4 raspi3                        Remote Disk Management
local
+ wlan0 IPv4 pizero                        Remote Disk Management
local
+ wlan0 IPv4 WDMMyCloud                    Apple File Sharing local
+ wlan0 IPv4 WDMMyCloud                    _wd-2go._tcp     local
+ wlan0 IPv4 WDMMyCloud                    Web Site         local
+ wlan0 IPv4 Living Room                   _googlecast._tcp local
+ wlan0 IPv4 123456789                     _teamviewer._tcp local
```

To access an mDNS advertized server from Microsoft Windows, you will need a service similar to Apple's Bonjour installed. Bonjour is distributed as part of Apple's iTunes product. Once installed, we should be able to access the published servers at their `<name>.local` address. A partner windows tool called "Bonjour Browser" is available which displays an mDNS listing of servers on windows.

See also:

- [avahi home page](#)
- [man\(1\) – avahi-browse](#)
- [man\(5\) – avahi-daemon.conf](#)

## Working with SNTP

SNTP is the Simple Network Time Protocol which allows a device connected to the Internet to learn the current time. In order to use this, you must know of at least one time server located on the Internet. The US National Institute for Science and Technology (NIST) maintains a number of these which can be found here:

- <http://tf.nist.gov/tf-cgi/servers.cgi>

Other time servers can be found all over the globe and I encourage you to Google search for your nearest or country specific server.

Once you know the identity of a server by its host name or IP address, you can call either of the functions called `sntp_setservername()` or `sntp_setserver()` to declare that we wish to use that time server instance. The ESP32 can be configured with up to three different time servers so that if one or two are not available, we might still get a result.

The ESP32 must also be told the local timezone in which it is running. This is set with a call to `sntp_set_timezone()` which takes the number of hours offset from UTC. For example, I am in Texas and my timezone offset becomes "-5". Although this function is present, I would suggest using the POSIX `tzset()` function instead.

With these configured, we can start the SNTP service on the ESP32 by calling `sntp_init()`. This will cause the device to determine its current time by sending packets over the network to the time servers and examining their responses. It is important to note that immediately after calling `sntp_init()`, you will not yet know what the current time may be. This is because it may take a few seconds for the ESP32 to send the time requests and get their responses and this will all happen asynchronously to your current commands and won't complete till sometime later.

One solution to using this is the following:

```
time_t now;
time(&now);
while (time < 5000) {
    vTaskDelay(1000*portTICK_RATE_MS);
```

```
    time(&now)
}
```

Here is an example of using SNTP to set the time:

```
ip_addr_t addr;
sntp_setoperatingmode(SNTP_OPMODE_POLL);
inet_pton(AF_INET, "129.6.15.28", &addr);
sntp_setserver(0, &addr);
sntp_init();
```

The time can be accessed from a variety of POSIX compliant functions including:

- `asctime` – Build a string representation of time.
- `clock` – Return processor time.
- `ctime` – Build a string representation of time.
- `difftime` – Calculate a time difference.
- `gettimeofday` – Retrieve the current time of day.
- `gmtime` – Produce a struct `tm` from a `time_t`.
- `localtime` – Produce a struct `tm` from a `time_t`.
- `settimeofday` – Set the current time.
- `strftime` – Format a `time_t` to a string.
- `time` – Get the current time as a `time_t` (seconds since epoch).

See also:

- SNTP API
- Timers and time
- `asctime`
- `ctime`
- `gmtime`
- `localtime`
- `strftime`
- `time`
- [IETF RFC5905: Network Time Protocol Version 4: Protocol and Algorithms Specification](#)
- [EpochConverter](#)

## Java Sockets

The sockets API is the defacto standard API for programming against TCP/IP. My programming language of choice is Java and it has full support for sockets. What this means is that I can write a Java based application that leverages sockets to communicate with the ESP32. I can send and receive data through quite easily.

In Java, there are two primary classes that represents sockets, those are `java.net.Socket` which represents a client application which will form a connection and the second class is `java.net.ServerSocket` which represents a server that is listening on a socket awaiting a client connection. Since the ESP32 can be either a client or a server, both of these Java classes will come into play.

To connect to an ESP32 running as a server, we need to know the IP address of the device and the port number on which it is listening. Once we know those, we can create an instance of the Java client with:

```
Socket clientSocket = new Socket(ipAddress, port);
```

This will form a connection to the ESP32. Now we can ask for both an `InputStream` from which to receive partner data and an `OutputStream` to which we can write data.

```
InputStream is = clientSocket.getInputStream();
OutputStream os = clientSocket.getOutputStream();
```

When we are finished with the connection, we should call `close()` to close the Java side of the connection:

```
clientSocket.close();
```

It really is as simple as that. Here is an example application:

```
package kolban;

import java.io.OutputStream;
import java.net.Socket;

import org.apache.commons.cli.CommandLine;
import org.apache.commons.cli.CommandLineParser;
import org.apache.commons.cli.DefaultParser;
import org.apache.commons.cli.Options;

public class SocketClient {
    private String hostname;
    private int port;

    public static void main(String[] args) {
        Options options = new Options();
        options.addOption("h", true, "hostname");
        options.addOption("p", true, "port");
        CommandLineParser parser = new DefaultParser();
        try {
            CommandLine cmd = parser.parse(options, args);

            SocketClient client = new SocketClient();
            client.hostname = cmd.getOptionValue("h");
            client.port = Integer.parseInt(cmd.getOptionValue("p"));
            client.run();
        } catch (Exception e) {
```

```

        e.printStackTrace();
    }
}

public void run() {
    try {
        int SIZE = 65000;
        byte data[] = new byte[SIZE];
        for (int i = 0; i < SIZE; i++) {
            data[i] = 'X';
        }
        Socket s1 = new Socket(hostname, port);
        OutputStream os = s1.getOutputStream();
        os.write(data);
        s1.close();
        System.out.println("Data sent!");
    } catch (Exception e) {
        e.printStackTrace();
    }
}
} // End of class
// End of file

```

To configure a Java application as a socket server is just as easy. This time we create an instance of the `SocketServer` class using:

```
SocketServer serverSocket = new SocketServer(port)
```

The port supplied is the port number on the machine on which the JVM is running that will be the endpoint of remote client connection requests. Once we have a `ServerSocket` instance, we need to wait for an incoming client connection. We do this using the blocking API method called `accept()`.

```
Socket partnerSocket = serverSocket.accept();
```

This call blocks until a client connect arrives. The returned `partnerSocket` is the connected socket to the partner which can be used in the same fashion as we previously discussed for client connections. This means that we can request the `InputStream` and `OutputStream` objects to read and write to and from the partner. Since Java is a multi-threaded language, once we wake up from `accept()` we can pass off the received partner socket to a new thread and repeat the `accept()` call for other parallel connections. Remember to `close()` any partner socket connections you receive when you are done with them.

So far, we have been talking about TCP oriented connections where once a connection is opened it stays open until closed during which time either end can send or receive independently from the other. Now we look at datagrams that use the UDP protocol.

The core class behind this is called `DatagramSocket`. Unlike TCP, the `DatagramSocket` class is used both for clients and servers.

First, let us look at a client. If we wish to write a Java UDP client, we will create an instance of a `DatagramSocket` using:

```
DatagramSocket clientSocket = new DatagramSocket();
```

Next we will "connect" to the remote UDP partner. We will need to know the IP address and port that the partner is listening upon. Although the API is called "connect", we need to realize that no connection is formed. Datagrams are connectionless so what we are actually doing is associating our client socket with the partner socket on the other end so that **when** we actually wish to send data, we will know where to send it to.

```
clientSocket.connect(ipAddress, port);
```

Now we are ready to send a datagram using the `send()` method:

```
DatagramPacket data = new DatagramPacket(new byte[100], 100);  
clientSocket.send(data);
```

To write a UDP listener that listens for incoming datagrams, we can use the following:

```
DatagramSocket serverSocket = new DatagramSocket(port);
```

The port here is the port number on the same machine as the JVM that will be used to listen for incoming UDP connections.

To wait for an incoming datagram, call `receive()`.

```
DatagramPacket data = new DatagramPacket(new byte[100], 100);  
clientSocket.receive(data);
```

If you are going to use the Java Socket APIs, read the JavaDoc thoroughly for these classes as there are many features and options that were not listed here.

See also:

- [Java tutorial: All About Sockets](#)
- [JDK 8 JavaDoc](#)

## Network performance tests

A well considered testing tool called iPerf is available for TCP and UDP network testing. A sample application that can be installed on the ESP32 is available that can be used with an iPerf server:

<https://github.com/espressif/esp-idf/tree/master/examples/wifi/iperf>

## Bluetooth

The ESP32 has native Bluetooth support (version 4.2). This means that it can interact with Bluetooth devices such as keyboards, mice and cell phones. Let us review what Bluetooth means for us. Bluetooth is a wireless communication protocol/technology that provides data transfer over a radio signal. Let us assume that ESP32 is one end of the connection and any other Bluetooth device can be at the other. For security purposes, arbitrary Bluetooth devices can't simply be "used" without some explicit authorization. For example, it would be very wrong if I could bring my Bluetooth headset near your phone and start listening to your calls. To achieve security, a process called "pairing" needs to be performed. This achieves a level of trust between the two Bluetooth devices such that they subsequently allow connection without having to be re-paired.

### Bluetooth specification

Bluetooth is a specification for wireless communication between multiple electronic devices. At present, there are two primary standards ... these are Bluetooth (Classic) and Bluetooth LE. The "LE" stands for Low Energy and is the specification for devices that wish to be powered by batteries and yet have sufficient life span.

In the Bluetooth story, we have devices which are "masters" and devices which are "slaves". A slave can only form a connection and communicate with a master while a master can form concurrent connections with multiple slaves. One slave can not directly communicate with another slave. Instead it must communicate with the master and the master relay the request.

The simplest communication is one master and one slave but if we have multiple slaves connected to the same master, the resulting "network" is termed a "piconet".

Each device that participates in the conversation has a unique address that is a 48 bit value commonly written as 12 hex values (6 bytes). This address is known as the "Bluetooth Device Address" and may be seen in other documentation abbreviated to "BD\_ADDR".

The encoding of a Bluetooth address is that the first 24 bits encode the organization responsible for allocating the remaining address and the remaining 24 bits are the address itself. However the full 48 bits are the complete identity of the device.

As well as having a unique address, each device can have a symbolic name to help us meaningfully identify it. This is termed the *display name*. The display name is only a mapping to a Bluetooth address and it is really the BD\_ADDR address that is used to distinguish one device from another. It is also important to note that there are no uniqueness constraints on device names. Multiple devices may select the same device name.



Let us assume that initially, we have two devices and neither of them know about the other. What must now happen is a discovery process. One of them will broadcast an "inquiry" request. Devices receiving the inquiry can respond with their own existence by transmitting their own address and possibly additional information. It is common that the response to an inquiry does not contain the display name of the responding device. If the display name is needed, the inquirer can transmit a directed request now that it knows the address of the responding device which will solicit the name as a further response.

A device does not have to respond to an inquiry request. It has a property setting called an "inquiry scan" that controls whether or not it responds to such. If the attribute is on, then it will respond to an inquiry request and if off, then it will not respond. Think of the phrase "inquiry scan" as the device's choice as to whether it performs the action of "scanning for inquires".

Once the two devices know each others addresses, a connection can be formed between them through a process known as "paging". Again, a device does not have to service a received connection request. It has a property setting called a "paging scan" which controls this. If on, then a paging request causes a new connection to be formed. If off, it will not accept a new connection request.

Once a connection is formed between the devices, that connection can be maintained in a variety of states, the most common being active. However other states are available and are used to save power when there is no active communication of data anticipated.

In order to permit devices to communicate with each other, there has to be an element of security involved. We usually don't want arbitrary devices to be able to connect with each other and share arbitrary information. To achieve this, a process called "bonding" is enacted. Bonding is achieved through the notion of "pairing". In pairing, the devices exchange their addresses, names and other data and generate keys that they share with each other. Pairing typically requires an explicit interaction from the user to permit the pairing to succeed. The user interaction can be as simple as "I approve this device" with a button click or it can be richer with the entry of a pass-code to authenticate and prove that one is who one claims to be.

The Bluetooth protocol provides support for different classes of power. This translates directly into the signal strength of the radio. Remember that the more power used by the radio, the heavier the drain on the power source. If the power source is batteries, the more power used to transmit data, the shorter the life of the batteries.

At the lower levels, Bluetooth takes care of exchanging data between partners. However, there is much more to Bluetooth than just simple data exchange. In order to provide interoperability between devices built by multiple manufacturers, higher level

protocols called "profiles" have been defined. These profiles define "what" is transmitted over Bluetooth for a given device function.

Some of the profiles we will come across include:

- `HSP` – Head Set Profile (eg. a Bluetooth ear piece).
- `HFP` – Hands Free Profile (eg. Bluetooth communication in a car).
- `HID` – Human Interface Device (eg. a keyboard or mouse).
- `SPP` – Serial Port Profile.
- `A2DP` – Advanced Audio Distribution profile (eg. connection to Bluetooth speakers).
- `AVRCP` – Audio Visual Remote Control Profile.

Knowing that these protocols exist, it is not sufficient that two Bluetooth devices are in range of each other, they must also both support the same profile that is desired to be used.

At a higher level than the connection are the transport protocols available to us. These include:

- `RFCOMM` – Radio Frequency Communications Protocol. This protocol provides a reliable stream oriented transmission. Loosely, you can compare it to TCP.
- `L2CAP` – Logical Link Control and Adaption Protocol. This is a packet oriented protocol. `RFCOMM` builds on `L2CAP`.
- `ACL` – Asynchronous Connection oriented Logical protocol. `L2CAP` builds on `ACL`.
- `SCO` – Voice quality audio protocol.

To allow multiple conversations to be processed in parallel, the concept of the "port" is introduced. This is similar to a TCP/IP port number. `L2CAP` ports can be odd numbered values between 1 and 32767. For `RFCOMM`, the port numbers are called channels and are between 1 and 30. In the Bluetooth documentation, ports are referred to as "Protocol Service Multiplexers" or "PSMs".

Certain port numbers used by `L2CAP` are designated as reserved for well defined purposes.

See also:

- [Introduction to Bluetooth Low Energy](#)

## Bluetooth UUIDs

A UUID is a 16 byte value (128 bits). They are commonly written in hexadecimal with 1 byte corresponding to 2 hex digits. The most common written format is 4-2-2-2-6 (bytes).

XXXXXXXX-XXXX-XXXX-XXXX-XXXXXXXXXXXX

When one receives a UUID, it is the value of the UUID that is used to describe the nature of the service or data. Each different type of service will have its own unique UUID.

Because 16 bytes is a lot of data to describe the identity of a service, we have the opportunity to describe a UUID in a shortened form of either 16bits or 32bits ... however these are reserved for services that are architected by the Bluetooth specification owners. If one implements one of those services, then we don't need to transmit the whole 128 bit UUID but can get away with less. A special UUID of the form:

XXXXXXXX-0000-1000-8000-00805F9B34FB

is available where only the first 4 bytes (32 bits) are needed to identify the type of service and

0000XXXX-0000-1000-8000-00805F9B34FB

is available where only the first 2 bytes (16 bits) are needed to identify the type of service.

Should we need, we can generate a UUID using the `uuidgen` command or from the web site [www.uuidgenerator.net](http://www.uuidgenerator.net).

## Bluetooth GAP

The Generic Access Protocol (GAP). It is GAP that determine which devices can interact with each other. In the GAP story there are primarily two classes of "things". There is the central device and the peripheral device.

We can send advertising using the Advertising Data payload or the Scan Response payload.

A peripheral device will constantly transmit its advertising payload which can contain up to 31 bytes of data. The peripheral transmits its advertising data every advertising interval period. The Advertising Data payload is present in all BT devices. If the central receiver of the advertising data payload wishes, it can request a scan response and the peripheral will send back a scan response payload.

When a peripheral is transmitting advertising data, we can think of it as being in the mode of broadcasting. It is transmitting its data which may or may not be seen by a corresponding central.

The concept of BLE advertising is powerful beyond just finding devices to form subsequent connections. The advertising packets can contain data in their payload. If the data being transmitted does not need to be secure (for example, the outside temperature), then we have the core of an interesting solution in its own right. The peripheral can simply broadcast its packets of data and the central can receive them without the need to form a connection. The receiver can then examine the payload and receive the data, as long as the data is small enough. In this story, the peripheral is performing the role of a "broadcaster" while the central would be performing the role of an "observer". When working in this mode, do realize that the data is flowing in only one direction ... from the publisher to the observer. If you need to send response back, you will need to form a connection.

The rate of advertising can be set to be a period between 20ms and 10.24seconds in steps of 0.625ms. Thus we can transmit our advertising packets frequently or slowly.

See also:

- [A BLE Advertising Primer](#)

#### Low level packet

At the lowest level, an advertising packet contains the following raw data. For the most part, we should never see this information.

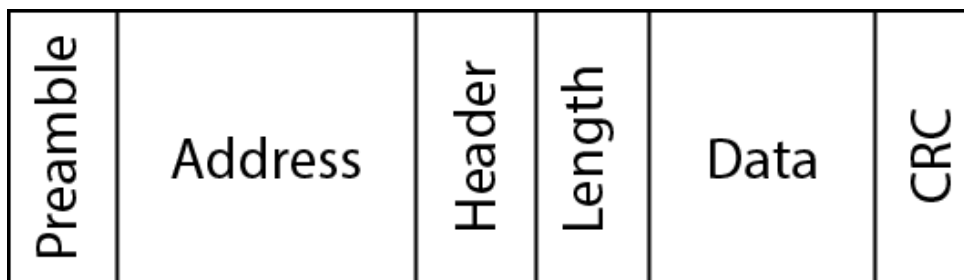

The header contains an advertising packet type which can be one of:

- ADV\_IND
- ADV\_DIRECT\_IND
- ADV\_NONCONN\_IND
- ADV\_SCAN\_IND
- SCAN\_REQ – A request to receive additional scan data.
- SCAN\_RSP – The response to a previous SCAN\_REQ.

- CONNECT\_REQ – A request to connect.

#### GAP Advertising data

There is theory and there is practice and studying BLE gives us the opportunity for both. Let us focus on the notion of a BLE peripheral broadcasting advertising messages. At a high level it will look like:

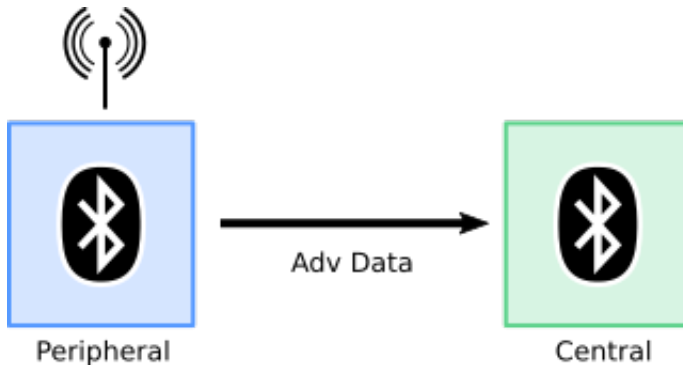

The advertiser repeats sending its advertisement at a rate as short as every 20ms or as long as every 10.28 seconds. This rate is called the advertising interval. A random fudge factor is added to the interval to ensure that we don't end up in lock-step with two or more advertisers always transmitting over each other.

The advertised data payload has a maximum size of 31 bytes. Each payload is composed of one or more data structures where the format of each structure is:

Length	Advertising Data Type	Data ...
--------	-----------------------	----------

The Length is 1 byte in size and indicates how many bytes, following the length byte, this record will be. The number of records in a payload is variable but, of course, the total amount of data has to be 31 bytes or less. Either a length of 0 or an ignorable structure type can be used.

Here is an example of a real payload that I received:

```
020105020A000319C1030302E0FF11094D4C452D313520202020202020
```

Now we can parse this as follows:

- 02 01 05 – advertising type 0x01; length 2 bytes
- 02 0a 00 – advertising type 0x0A; length 2 bytes
- 03 19 c1 03 – advertising type 0x19; length 3 bytes
- 03 02 e0 ff – advertising type 0x02; length 3 bytes

11 09 4d 4c 45 2d 31 35 20 20 20 20 20 20 20 20 – advertising type 09; length 17 bytes.

Here is a simple routine that will step through the structures ...

```
while(!finished) {
    length = *payload;
    payload++;
    if (length != 0) {
        ad_type = *payload;
        payload += length;
        ESP_LOGD(tag, "Type: 0x%.2x, length: %d", ad_type, length);
    }
    sizeConsumed += 1 + length;
    if (sizeConsumed >= 31 || length == 0) {
        finished = 1;
    }
} // !finished
```

Now that we know how to see the structures and access them, the obvious question is what do each of the structures "mean". For most, they are architected in the BLE specification. Each structure (after the length) has a single byte that is the "advertising data type". These single byte number codes are described here:

<https://www.bluetooth.com/specifications/assigned-numbers/generic-access-profile>

In our ESP32 environment, we have constant definitions for each:

- `ESP_BLE_AD_TYPE_FLAG (0x01)` – The advert contains a byte of flags that are defined as following:
  - Bit 0 – LE Limited Discoverable Mode
  - Bit 1 – LE General Discoverable Mode
  - Bit 2 – BR/EDR is NOT supported.
  - Bit 3 – Indicates whether LE and BR/EDR Controller operates simultaneously
  - Bit 4 – Indicates whether LE and BR/EDR Host operates simultaneously
  - Bits 5-7 – Reserved.
- `ESP_BLE_AD_TYPE_16SRV_PART (0x02)` – Incomplete list of 16bit service UUIDs.
- `ESP_BLE_AD_TYPE_16SRV_CMPL (0x03)` – Complete list of 16 bit service UUIDs.
- `ESP_BLE_AD_TYPE_32SRV_PART (0x04)` – Incomplete list of 32bit service UUIDs.
- `ESP_BLE_AD_TYPE_32SRV_CMPL (0x05)` – Complete list of 32bit service UUIDs.
- `ESP_BLE_AD_TYPE_128SRV_PART (0x06)` – Incomplete list of 128bit service UUIDs.
- `ESP_BLE_AD_TYPE_128SRV_CMPL (x07)` – Complete list of 128bit service UUIDs.

- ESP\_BLE\_AD\_TYPE\_NAME\_SHORT (0x08) – Shortened local name.
- ESP\_BLE\_AD\_TYPE\_NAME\_CMPL (0x09) – Complete local name.
- ESP\_BLE\_AD\_TYPE\_TX\_PWR (0x0A) – Transmit power level.
- ESP\_BLE\_AD\_TYPE\_DEV\_CLASS (0x0D)
- ESP\_BLE\_AD\_TYPE\_SM\_TK (0x10)
- ESP\_BLE\_AD\_TYPE\_SM\_OOB\_FLAG (0x11)
- ESP\_BLE\_AD\_TYPE\_INT\_RANGE (0x12)
- ESP\_BLE\_AD\_TYPE\_SOL\_SRV\_UUID (0x14)
- ESP\_BLE\_AD\_TYPE\_128SOL\_SRV\_UUID (0x15)
- ESP\_BLE\_AD\_TYPE\_SERVICE\_DATA (0x16)
- ESP\_BLE\_AD\_TYPE\_PUBLIC\_TARGET (0x17)
- ESP\_BLE\_AD\_TYPE\_RANDOM\_TARGET (0x18)
- ESP\_BLE\_AD\_TYPE\_APPEARANCE (0x19) – It is likely this conforms to the assigned numbers found here <https://www.bluetooth.com/specifications/gatt/viewer?attributeXmlFile=org.bluetooth.characteristic.gap.appearance.xml>.
- ESP\_BLE\_AD\_TYPE\_ADV\_INT (0x1A)
- ESP\_BLE\_AD\_TYPE\_32SOL\_SRV\_UUID (0x1B)
- ESP\_BLE\_AD\_TYPE\_32SERVICE\_DATA (0x1C)
- ESP\_BLE\_AD\_TYPE\_128SERVICE\_DATA (0x1D)
- ESP\_BLE\_AD\_MANUFACTURER\_SPECIFIC\_TYPE (0xFF) – Custom payload.

With this in mind, if we look at our sample data ... we can see that it means:

```
02 01 05 – advertising type 0x01 – ESP_BLE_AD_TYPE_FLAG
02 0a 00 – advertising type 0x0A – ESP_BLE_AD_TYPE_TX_PWR
03 19 c1 03 – advertising type 0x19 – ESP_BLE_AD_TYPE_APPEARANCE
03 02 e0 ff – advertising type 0x02 – ESP_BLE_AD_TYPE_16SRV_PART
11 09 4d 4c 45 2d 31 35 20 20 20 20 20 20 20 20 20 20 – advertising type 0x09 –
ESP_BLE_AD_TYPE_NAME_CMPL
```

Now we can consult the specification and determine what the data part of each advertising type means and we have our information.

Because examining the advertising data of a GAP message is so important and so common, the ESP-IDF contains a very useful utility function that takes as an input the advertisement data and looks for an advertising type structure within it of a defined type. The function is called `esp_ble_resolve_adv_data()`.

See also:

- `esp_ble_resolve_adv_data`
- `esp_ble_gap_start_advertising`
- `esp_ble_gap_config_adv_data_raw`
- `esp_ble_gap_config_scan_rsp_data_raw`

### Advertisability - limited and general

Is "advertisability" even a real word? I think not ... but it describes what we want to cover. When we have a bluetooth peripheral, we somehow need to make it available to be discovered by a bluetooth central in order for the central to make requests of the peripheral. The way we achieve this is by making the peripheral visible by it broadcasting its advertising packets. When a peripheral starts advertising, it can tag the advertisement as either limited-discoverable or general-discoverable. The notion here is that limited-discoverable devices have "recently" been enabled to start broadcasting while "general-discoverable" devices usually broadcast continuously. "So what" you may ask? Well, think of a user looking for a device. It is not uncommon for a new device to be added by pressing some button on it to start it broadcasting so that it can be found and paired. We want this new device to show up higher in the list of found devices than others ... and this can be achieved by recognizing that a device which only broadcasts for a limited period of time will enable its "limited-discoverable" flag and provide a hint to the software running on the central that the device is likely going to be the one the user is looking for.

A general advertising packet is flagged as `ADV_IND`.

### Directed advertising

Another form of advertising is called directed. In this mode, the advertiser flags the advert as being "direct" and the packet contains the address of the peripheral doing the advertising and the address of the central with which it wishes to connect. On receipt of such a packet, the central can choose to immediately form a connection.

A directed advertising packet is flagged as `ADV_DIRECT_IND`.

### Non-connectable advertising

An advert packet can be flagged as non-connectable. This indicates to the central that it should not attempt to form a connection. This mode is typically used by Publishers who merely publish information to be found by observers.



A non-connectable advertising packet is flagged as `ADV_NONCONN_IND`.

### Filtering devices

When we are looking for a device, we may find more devices than we want. Rather than present all devices to the user, we can choose to filter the set of available devices and hide the ones that we believe are not of interest. For example, if I am running a heart-rate monitor application on my phone, I'm really only interested in devices that can provide such information. My latest bluetooth headset or the outside temperature is not what I'm looking for. What we want to do is filter the set of ALL found devices down to only the ones that match some criteria of interest to us. In order for that to happen, each device must not only advertise its existence, but also supply information that can be used to include or eliminate it from selection.

### Performing a scan

There isn't much value in generating advertising data if no-one is listening. In BLE the act of listening for advertising data is called "scanning". To perform a scan in the ESP32 we perform the following tasks:

1. We register a callback function to handle the received data.
2. We define the parameters for how we would like the scan to be performed.
3. We ask the ESP32 to start scanning.

Translating these into ESP32 APIs we have `esp_ble_gap_register_callback()` to register our GAP event callback function to be invoked when events arrive.

We have the `esp_ble_gap_set_scan_params()` to setup how we wish the scanning to be performed.

We have `esp_ble_gap_start_scanning()` to initiate a scan request.

If we need to interrupt our scanning before the requested duration of scanning has completed, we can call `esp_ble_gap_stop_scanning()`.

The function registered when we call `esp_ble_gap_register_callback()` is where the majority of our logic will happen. The parameter to this registration function is itself a C function which the following signature:

```
void gap_event_handler(  
    esp_gap_ble_cb_event_t event,  
    esp_ble_gap_cb_param_t *param)
```

The `param` is a union of structures.

Event Type	Data Property
ESP_GAP_BLE_ADV_DATA_SET_COMPLETE_EVT	adv_data_cmpl
ESP_GAP_BLE_ADV_DATA_RAW_SET_COMPLETE_EVT	adv_data_raw_cmpl
ESP_GAP_BLE_ADV_START_COMPLETE_EVT	adv_start_cmpl
ESP_GAP_BLE_SCAN_PARAM_SET_COMPLETE_EVT	scan_param_cmpl
ESP_GAP_BLE_SCAN_RESULT_EVT	scan_rst
ESP_GAP_BLE_SCAN_RSP_DATA_RAW_SET_COMPLETE_EVT	scan_rsp_data_raw_cmpl
ESP_GAP_BLE_SCAN_RSP_DATA_SET_COMPLETE_EVT	scan_rsp_data_cmpl
ESP_GAP_BLE_SCAN_START_COMPLETE_EVT	scan_start_cmpl

The `event` parameter defines the type of event we have received. Event types include:

- ESP\_GAP\_BLE\_ADV\_DATA\_RAW\_SET\_COMPLETE\_EVT – Raw advertising data operation complete.
- ESP\_GAP\_BLE\_ADV\_DATA\_SET\_COMPLETE\_EVT – Called when advertising data set is complete. Structure parameter is called `scan_rsp_data_cmpl`.
  - `esp_bt_status_t status` – The status of the event.
- ESP\_GAP\_BLE\_ADV\_START\_COMPLETE\_EVT – Called when advertising scan startup is complete. The parameter is a property called `scan_start_cmpl` which contains:
  - `esp_bt_status_t status` – The status of the event.
- ESP\_GAP\_BLE\_SCAN\_PARAM\_SET\_COMPLETE\_EVT – Called when scan parameters set complete. Structure parameter is called `scan_param_cmpl`.
  - `esp_bt_status_t status`
- ESP\_GAP\_BLE\_SCAN\_RESULT\_EVT – The `param` is an instance of `esp_ble_gap_cb_param_t`. Called when one scan result is ready. The structure parameter is called `scan_rst`.
  - `esp_gap_search_evt_t search_evt` – Choices are:
    - ESP\_GAP\_SEARCH\_INQ\_RES\_EVT – We have received a search result.
    - ESP\_GAP\_SEARCH\_INQ\_CMPL\_EVT – The search is complete.
    - ESP\_GAP\_SEARCH\_DISC\_RES\_EVT
    - ESP\_GAP\_SEARCH\_DISC\_BLE\_RES\_EVT
    - ESP\_GAP\_SEARCH\_DISC\_CMPL\_EVT
    - ESP\_GAP\_SEARCH\_DI\_DISC\_CMPL\_EVT

- ESP\_GAP\_SEARCH\_SEARCH\_CANCEL\_CMPL\_EVT
- esp\_bd\_addr\_t bda – The address of the device. 6 bytes of data.
- esp\_bt\_dev\_type\_t dev\_type – One of:
  - ESP\_BT\_DEVICE\_TYPE\_BREDR
  - ESP\_BT\_DEVICE\_TYPE\_BLE
  - ESP\_BT\_DEVICE\_TYPE\_DUMO
- esp\_ble\_addr\_type\_t ble\_addr\_type – One of
  - BLE\_ADDR\_TYPE\_PUBLIC
  - BLE\_ADDR\_TYPE\_RANDOM
  - BLE\_ADDR\_TYPE\_RPA\_PUBLIC
  - BLE\_ADDR\_TYPE\_RPA\_RANDOM
- esp\_ble\_evt\_type\_t ble\_evt\_type – One of
  - ESP\_BLE\_EVT\_CONN\_ADV
  - ESP\_BLE\_EVT\_CONN\_DIR\_ADV
  - ESP\_BLE\_EVT\_DISC\_ADV
  - ESP\_BLE\_EVT\_NON\_CONN\_ADV
  - ESP\_BLE\_EVT\_SCAN\_RSP
- int rssi – The signal strength.
- uint8\_t ble\_adv[ESP\_BLE\_ADV\_DATA\_LEN\_MAX] – The advertised data.
- int flag – Flags
  - bit 0 – Limited Discoverable
  - bit 1 – General Discoverable
  - bit 2 – BR/EDR not supported
  - bit 3 – Simultaneous LE and BR/EDR (Controller)
  - bit 4 – Simultaneous LE and BR/EDR (Host)
- int num\_resps – The number of responses received. This is valid when the search\_evt type is ESP\_GAP\_SEARCH\_INQ\_CMPL\_EVT.
- uint8\_t adv\_data\_len

- `uint8_t scan_rsp_len`
- `ESP_GAP_BLE_SCAN_RSP_DATA_RAW_SET_COMPLETE_EVT` – ???.
- `ESP_GAP_BLE_SCAN_RSP_DATA_SET_COMPLETE_EVT` – Called when the scan response data set is complete. Structure parameter is called: `scan_rsp_data_cmpl`.
  - `esp_bt_status_t status`
- `ESP_GAP_BLE_SCAN_START_COMPLETE_EVT` – ???.

A typical series of events received might be:

- `ESP_GAP_BLE_SCAN_PARAM_SET_COMPLETE_EVT`
- `ESP_GAP_BLE_SCAN_START_COMPLETE_EVT`
- `ESP_GAP_BLE_SCAN_RESULT_EVT` – `ESP_GAP_SEARCH_INQ_RES_EVT`
- ...
- `ESP_GAP_BLE_SCAN_RESULT_EVT` – `ESP_GAP_SEARCH_INQ_CMPL_EVT`

See also:

- `esp_ble_gap_register_callback`
- Error: Reference source not found
- `esp_ble_gap_start_scanning`
- `esp_ble_gap_stop_scanning`

### Performing advertising

If our ESP32 is going to be a peripheral, then it will be advertising its existence. The ESP-IDF provides some APIs to achieve that task. At a high level:

1. Call `esp_ble_gap_config_adv_data()` to specify the content of our periodic advertisement.
2. Call `esp_ble_gap_start_advertising()` to initiate the periodic advertisement.

While superficially simple, we need to consider all the distinct parameters that are available to us ... and there are many.

We will start with the `esp_ble_gap_config_adv_data()`. This is where we specify the content of the advertisement payload. An example structure would be:

```

static esp_ble_adv_data_t test_adv_data;
test_adv_data.set_scan_rsp      = false,
test_adv_data.include_name     = true,
test_adv_data.include_txpower  = true,
test_adv_data.min_interval     = 0x20,
test_adv_data.max_interval     = 0x40,
test_adv_data.appearance      = 0x00,
test_adv_data.manufacturer_len = 0,
test_adv_data.p_manufacturer_data = NULL,
test_adv_data.service_data_len = 0,
test_adv_data.p_service_data   = NULL,
test_adv_data.service_uuid_len = 32,
test_adv_data.p_service_uuid   = test_service_uuid128,
test_adv_data.flag              = 0x2,
};

```

Once we have started advertising, we can check the published information using:

```
$ sudo hcitool lescan
```

See also:

- esp\_ble\_gap\_config\_adv\_data
- esp\_ble\_gap\_start\_advertising
- esp\_ble\_gap\_stop\_advertising

## Bluetooth GATT

The Generic Attribute Protocol (strangely called GATT) provides a mechanism for passing data in a standard form. GATT is always present in BLE. Think of GATT as a way to send and receive data that is "remembered" at the GATT server (while it is running). A client can explicitly request the values of data items as well as receive pushed asynchronous notifications as events when something interesting happens at the GATT server.

In this model of an attribute, each attribute consists of a row in the table. The "handle" property of the attribute forms its key. It is important to note that a handle is not the same as a row number. Handles need not be consecutive. However, no two attributes can have the same handle value. How the server internally manages the attributes is not part of the specification and is left to the BLE run-time designers.

At the high level of the protocol there is the concept of a service. The service is the grouping of functionally related attributes. Each service has its own UUID. Within a service are characteristics where a characteristic is a property of that service. Each characteristic type is identified by its own UUID value. In addition a characteristic contains a value, properties, security and may also include descriptors.

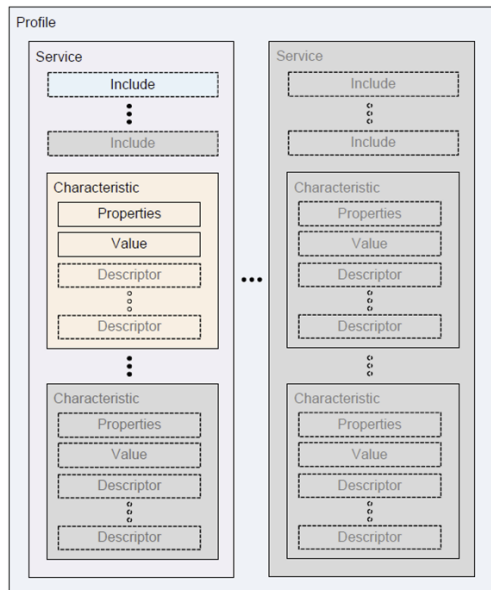

Within the specification of GATT we have the notion of two roles ... namely that of a client and that of a server. A GATT server is commonly a passive entity that waits for requests from GATT clients and services them as they arrive.

When a GATT client starts, it assumes little about the GATT server and first performs an inquiry upon the server to determine its services and characteristics.

Every BLE device **must** include the capability to be a GATT server.

Before we talk more about GATT, let us first talk about ATT. ATT is the Attribute Protocol and serves as the underpinnings for GATT. Think of a logical server that maintains a set of attributes. We define an attribute as consisting of:

- `handle` – A 16 bit number representing the key/identity of the attribute.
- `type` – 128 bit UUID describing the type of the attribute.
- `permissions` – Permissions on the attribute. The permissions can be:
  - None
  - Read
  - Write
  - Read/Write
- `value` – The value of the attribute. Can be up to 512 bytes.

Loosely, we can think of the attributes as being in a table form:

handle1	type1	permissions1	value1
handle2	type2	permissions2	value2
handle3	type3	permissions3	value3
handle...	type...	permissions...	value...

The GATT server manages attributes that can be read by or written from a GATT client. How these attributes are stored by the GATT server internally is not defined in the specification and left to the implementers to choose.

This story of raw attributes is further specified in the GATT protocol by the notion of services and characteristics.

Think of a service a logical description that a GATT server is prepared to do something that is well defined. If it claims to provide a service, then it must adhere to the contract described by that service. This contract of a service is defined by a set of characteristics and the set of those make up the service.

When we define a new service, an entry is added to the table that looks like:

handle	UUID <sub>primaryService</sub> (0x2800)	permissions	UUID of service
handle	UUID <sub>characteristic</sub> (0x2803)	permissions	... data ...

See also:

- [Generic Attribute Profile \(GATT\)](#)
- [generic attributes \(gatt\) and the generic attribute profile](#)
- [GATT-Based specifications](#)
- [GATT services](#) – Assigned numbers
- [GATT delarations](#) – Assigned number
- [GATT characteristics](#) – Assigned numbers
- gatttool

### GATT Characteristic

Working on the notion that in the underlying story everything is an attribute, let us explain the concept of characteristics in terms of attributes.

Each characteristic is declared as:

<handle>	UUID (0x2803)	Read only	<ul style="list-style-type: none"> <li>• properties – 1 byte</li> <li>• value handle – 2 bytes</li> <li>• characteristic UUID – 2, 4 or 16 bytes</li> </ul>
----------	---------------	-----------	---

The properties are a bit field including:

- `broadcast` – Characteristic value can be in advertising packets.
- `read` – Client may read the characteristic value.
- `write` – Client may write the characteristic value and send a response.
- `write without response` – Client may write the characteristic value with no response.
- `notify` – Value notification available.
- `indicate` – Value indication available.
- `signed write command` – ???

### Being a GATT client

From the ESP32 perspective, to be a GATT client we perform:

1. Register a callback to receive GATT events using `esp_ble_gattc_register_callback()`.
2. Call `esp_ble_gattc_app_register()` to register this application.
3. Open a connection to the GATT server using `esp_ble_gattc_open()`.
4. When an open event arrives, execute a search using `esp_ble_gattc_search_service()`.

When we call `esp_ble_gattc_open()` we are requesting to open a GATT connection to a specific device. This request is non-blocking and will execute in the background. Eventually we will receive a GATT event indicating the outcome. The event type will be `ESP_GATTC_OPEN_EVT`.



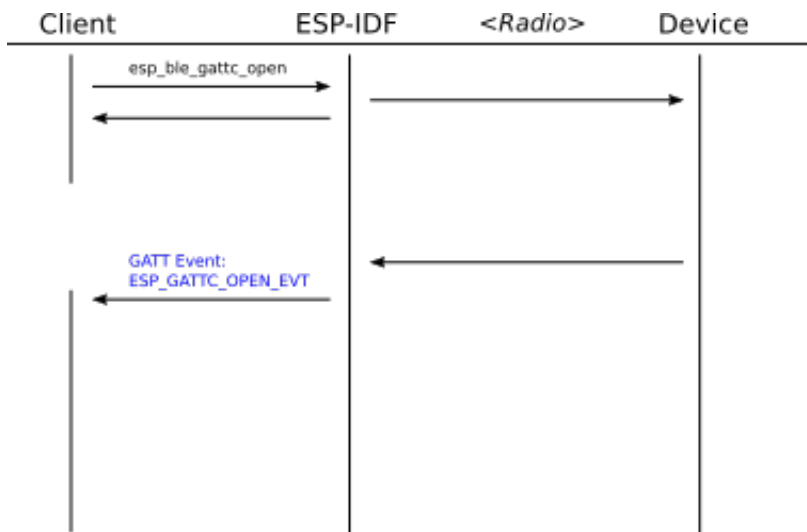

As part of the response data from the `ESP_GATTC_OPEN_EVT` we will receive a connection identifier (`conn_id`). This `conn_id` can be loosely thought of as a socket to the partner device.

Once we have formed a connection to the partner device, we can ask it about the services that it offers. We do this by calling `esp_ble_gattc_search_service()` function. Like other BLE mechanisms, this is an asynchronous operation that results in a series of GATT events being generated. For each service possessed by the device, an `ESP_GATTC_SEARCH_RES_EVT` is fired and finally, when we have seen all the services, we get an `ESP_GATTC_SEARCH_CMPL_EVT`. This is illustrated in the following diagram:

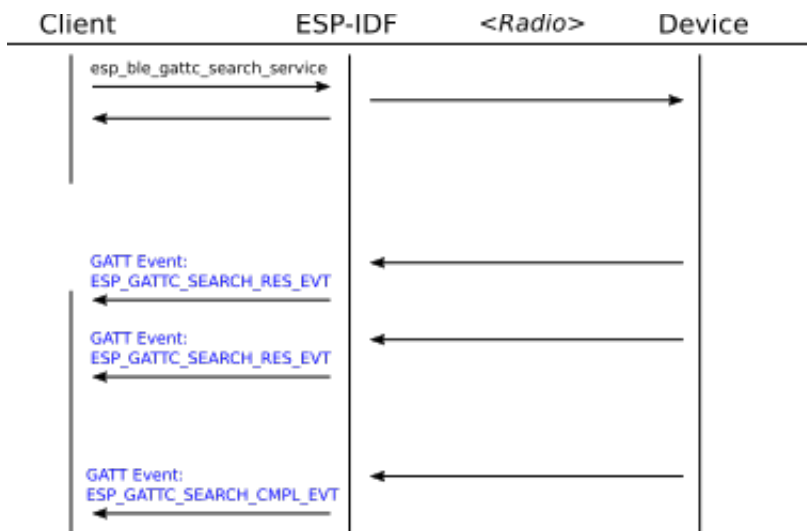

For each of the services we get back we can start to invoke those services on the device.

See also:

- `esp_ble_gattc_register_callback`
- `esp_ble_gattc_app_register`
- `esp_ble_gattc_open`
- `esp_ble_gattc_search_service`
- [GATT Services](#)

## Being a GATT Server

The high level of being a GATT server is:

```
esp_bt_controller_init()
esp_bt_controller_enable()
esp_bluedroid_init()
esp_bluedroid_enable()
esp_ble_gatts_register_callback()
esp_ble_gap_register_callback()
esp_ble_gatts_app_register()
```

The call to `esp_ble_gatts_app_register()` registers our application. This passes control back to the BLE subsystem and, when ready, will call back the GATT server event handler with an event type of `ESP_GATTS_REG_EVT`. When we receive that, we then do the next part of the setup:

```
esp_ble_gap_set_device_name()
esp_ble_gap_config_adv_data()
esp_ble_gatts_create_service()
```

To test that all is working, we can run the `hcitool` from a Linux system:

```
$ sudo hcitool lescan
24:0A:C4:00:00:96 MYDEVICE
```

See also:

- `esp_ble_gatts_register_callback`
- `esp_ble_gap_register_callback`
- `esp_ble_gap_set_device_name`
- `esp_ble_gap_config_adv_data`
- `esp_ble_gatts_app_register`
- `esp_ble_gatts_create_service`

## Notifications and indications

We might not want a BLE client to continuously poll a BLE server to read a characteristic value to determine if and when it changes. There are two primary downsides to this. The first is that if we assume that in the majority of cases there will have been no change, we are wasting energy asking for a value, waking up the server and being told it hasn't changed. Instead what we want is an interrupt mechanism. This is where notifications and indications come into play. When a client connects to the

server, the server can *push* notifications that a value has changed to the client. This way the client doesn't have to do any work except when it is informed that the value changed. No radio transmissions are occurring until the value changes.

This takes us to the second down-side of polling. If we are polling, we are presumably waiting between polls. In that case we have a latency between when a value does change and when the peer is notified. This latency is reduced in the notification story.

A notification is a "fire and forget" story. The server that is informed that its value changes notifies its peer without ever knowing that the peer received (or did not receive) the notification. Similar to notifications is the concept of an indication. Like a notification, nothing is transmitted to the peer until the value is flagged as having changed ... however, unlike notification, an indication will result in an acknowledgment that the partner received the update.

Associated with polling and notification is the Client Characteristic Descriptor with UUID 0x2902. This contains a couple of flags. One for notification and one for indication. A server which is able to generate notifications or indications for a given characteristic should have this descriptor associated with it. Before actually performing a notification or indication, the server should check the bits in the flags before performing the operation. The client will update the bits if it desires to have notifications or indications performed. It is presumed that this protocol is in place to prevent a server expending radio transmission energy when a notification would be produced but a client isn't interested in receiving at this time.

#### [GATT XML descriptions](#)

The GATT service, characteristic, descriptors and declaration descriptions are available as XML documents.

See also:

- [GATT XML](#)

### **Service Discovery Protocol**

When a client application wishes to request that a connection be established, the client needs to know the port number on which the server is listening. In TCP/IP land, this is achieved by having the client and the server share the implicit knowledge of the port number to use. In Bluetooth, extra functions have been made available. Specifically, there is a service available called the Service Discovery Protocol or "SDP". At the server, when a service is offered, the port number of that service is registered to the local SDP. When a client now wishes to use the target service, it first requests endpoint information from the SDP running on the server. The SDP returns the endpoint information and the client now has all the information it needs to create a direct

connection to the desired target service. The unit of information managed by the SDP server is called a "service record" or "SDP record".

A command line interface tool called `sdptool` is available to examine a Bluetooth device's SDP data. A simple command is:

```
$ sdptool browse <Bluetooth Address>
```

This returns a series of records of the form:

- Service Name
- Service Description
- Service Provider
- Service RecHandler
- Service Class ID List
- Protocol Descriptor List
- Profile Descriptor List
- Language Base Attr List

See also:

- [man\(1\) – sdptool](#)

## ESP32 and Bluetooth

Logic appears to be:

```
esp_bt_controller_init()
esp_bt_controller_enable(ESP_BT_MODE_BTDM)
esp_bluedroid_init()
esp_bluedroid_enable()
esp_ble_gap_register_callback()
esp_ble_gattc_register_callback()
esp_ble_gattc_app_register()
esp_ble_gap_set_scan_params()
esp_ble_gap_start_scanning(20)
```

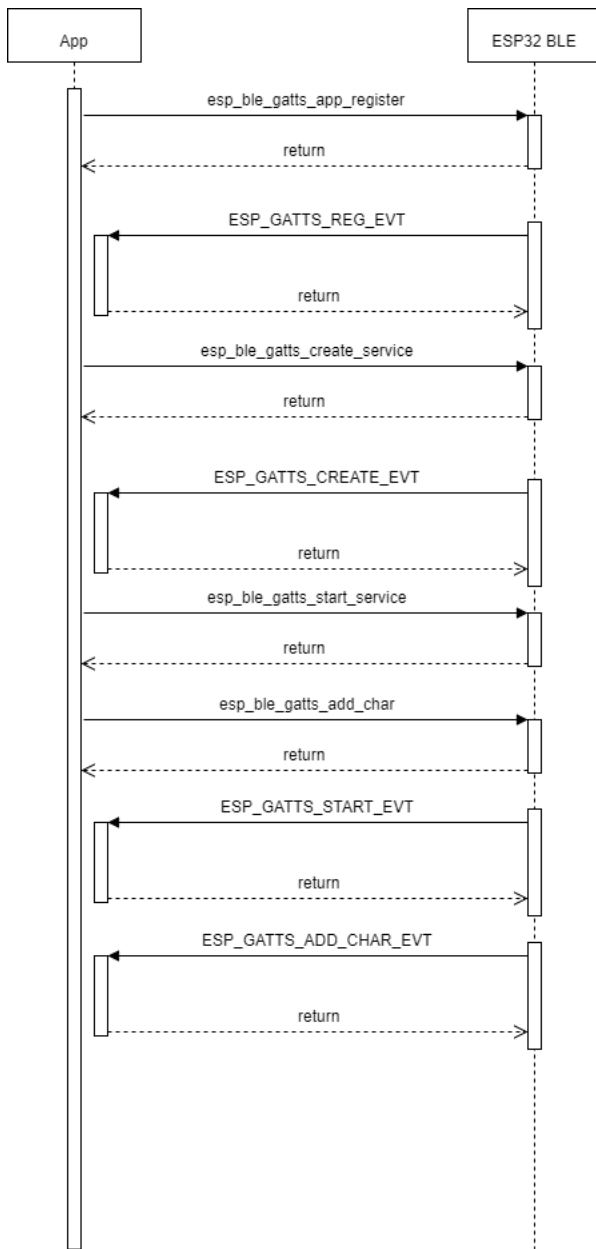

## GATT Server - Read request

When a partner requests that a characteristic be read, an `ESP_GATTS_READ_EVT` is received. This should send a response using the `esp_ble_gatts_send_response()` function.

We can test this with gatttool

```

$ sudo gatttool --device=<deviceAddr> --interactive
??> connect
??> char-read-uuid <charUUID>
  
```

handle: 0x???? value: ??

### See also:

- ESP\_GATTS\_READ\_EVT
- esp\_ble\_gatts\_send\_response

## Debugging ESP32 Bluetooth

The ESP32 bluetooth implementation is built upon an environment called Bluedroid. The reason this becomes important is that for **full** understanding of the ESP32 Bluetooth environment, we need to understand the Bluedroid environment as well. For example, the art of getting lower level diagnostics drops us down to the Bluedroid APIs. For example:

```
#include <gatt_api.h> // bluedroid include
...
GATT_SetTraceLevel(6);
```

will switch on GATT level tracing.

## Bluetooth C Programming in Linux

Within the C / Linux environment we have an implementation of the API stack called "BlueZ". The BlueZ implementation supports RFCOMM, L2CAP, SCO and HCI.

In order to perform Bluetooth programming we must install the package called "libbluetooth-dev" using:

```
$ sudo apt-get install libbluetooth-dev
```

When compiling, we need to link with libbluetooth.

### See also:

- [An Introduction to Bluetooth Programming](#)

## hci\_get\_route

Retrieve a handle to the specified Bluetooth device or the first available if NULL is supplied.

```
int hci_get_route(bdaddr_t *bdaddr)
```

## hci\_open\_dev

Open the specified device and get a handle to that device. The returned value is a socket.

```
int hci_open_dev(int dev_id)
```

If the return is -1 then an error was encountered and the details of the error can be found in `errno`.

## hci\_inquiry

```
int hci_inquiry(  
    int dev_id,  
    int len,  
    int max_rsp,  
    const uint8_t *lap,  
    inquiry_info **ii,  
    long flags)
```

where:

- `dev_id` – the device id of the adapter as returned by `hci_get_route`.
- `len` – The duration of the scan \* 1.28 seconds.
- `max_rsp` – The maximum number of responses we are willing to accept.
- `lap` – may be NULL
- `ii` – Pointer to an array of `inquiry_info` structures to be populated. The storage must exist and be at least of size `max_rsp * sizeof(inquiry_info)`.
- `flags`
  - 0 – Cached results allowed
  - `IREQ_CACHE_FLUSH` – Any cached values are discarded and only new responses will be used.

The `inquiry_info` is a struct containing:

- `bdaddr_t bdaddr`
- `uint8_t pscan_rep_mode`
- `uint8_t pscan_period_mode`
- `uint8_t pscan_mode`
- `uint8_t dev_class[3]` – The device class is encoded in the assigned numbers – baseband.
- `uint16_t clock_offset`

See also:

- [Assigned numbers – baseband](#)

## hci\_read\_remote\_name

Retrieve the display name of a specified device.

```
int hci_read_remote_name(  
    int hci_sock,  
    const baddr_t *addr,  
    int len,  
    char *name,  
    int timeout  
)
```

- `len` – the size of the name buffer to hold the display name.
- `name` – a buffer to hold the display name.
- `timeout` – Maximum number of milliseconds to wait before giving up.

On return, a value of 0 indicates success.

## str2ba

Convert a string representation of a Bluetooth address into an address.

```
str2ba(const char *str, bdaddr_t *ba)
```

Where `str` is the string representation of the Bluetooth address and `ba` is a pointer to a `bdaddr_t` structure to hold the resulting address.

## ba2str

Convert a Bluetooth address to a string. The string buffer must be at least 18 bytes long.

```
ba2str(const bdaddr_t *ba, char *str)
```

The `ba` is a pointer to a `bdaddr_t` structure while `str` is the buffer to be populated with the string representation.

`sdp_connect()`

`sdp_service_search_attr_req()`

`sdp_record_register()`



## Bluetooth programming in Node.js

Node.js provides the environment to write JavaScript applications that run on servers. These servers include Windows, Linux and Mac. By default, Node provides the core functions for running JavaScript with extensions for networking and file system and a few more. Natively, it knows nothing about working with Bluetooth. However, Node is extensible through an excellent package management system called `npm`. One of the packages available is called "Noble" which provides a BLE client (Central) on top of Node. In addition there is "Bleno" which provides a BLE Server.

See also:

- [npm: noble](#)
- [npm: bleno](#)
- [Github: sandeepmistry/noble](#)
- [Github: sandeepmistry/bleno](#)

## Using Noble

To use noble, we would issue a require of the package "noble" package after installing it using npm. For example:

```
var noble = require("noble");
```

To determine what BLE servers (peripherals) are out there, we would next perform a scan to locate them. We can do this with:

```
noble.startScanning()
```

Scanning continues until we explicitly ask to stop with a call to:

```
noble.stopScanning()
```

Events are generated through scanning and we can register handlers for them using:

- `noble.on("scanStart", callback)` – Be informed when scanning starts.
- `noble.on("scanStop", callback)` – Be informed when scanning ends.
- `noble.on("discover", callback(peripheral))` – Be informed when a new BLE peripheral is found.

When a `peripheral` is discovered, we are passed an object that represents it which contains:

```
{
  id: BD address
  uuid: BD address
  address: BD address
```

```

addressType: "public" or ...
connectable: true or false
advertisement: {
  localName: Name of device.
  txPowerLevel:
  manufacturerData:
  serviceData:
  serviceUuids:
  solicitationServiceUuids:
  serviceSolicitationUuids:
}
rssi:
services:
state: "connected" or "disconnected" or ...
}

```

The peripheral object contains methods including:

- `connect()` - Connect to the BLE server.
- `disconnect()` - Disconnect from the BLE server.
- `discoverServices()` - Discover the services offered by the server.

Once we have discovered a peripheral, we can select it and perform work against it. The `connect()` method allows us to connect to it. This method takes a callback function that is invoked when the connection has been completed.

For example:

```

function onConnect(error) {
  // Perform work here after being connected.
}
...
peripheral.connect(onConnect);

```

Once we are connected, we can now interrogate the BLE peripheral and ask it about the services it offers. We do this through the `discoverServices()` function. This takes a callback function that is passed an array of found services. For any given service, it is uniquely identified by a `serviceUuid`. We can examine the uuids and work with the ones we want. The `discoverServices()` function can filter our services so that only the ones of interest to us are returned. Remember that a BLE service is a container of characteristics so next we will ask the service for the set of characteristics for which it has management. We do this by invoking the `discoverCharacteristics()` method on our service object. This results in the characteristics we can read and write. From a characteristic object, we can invoke `read()` to read a value and `write()` to write a value.

Tech reference:

noble object

- `startScanning(serviceUids, allowDuplicates, callback)` – Start scanning for advertised devices.
- `stopScanning(callback)` – Stop scanning following a previous start scanning.
- `read(PeripheralUuid, serviceUuid, characteristicUuid)` – Read the value of a characteristic. This is a convenience function.
- `write(PeripheralUuid, serviceUuid, characteristicUuid, data, withoutResponse)` – Write the value of a characteristic. This is a convenience function.
- **events:**
  - `stateChange` – The state of Bluetooth has changed. The signature for the event handling function is `callback(state)`.
  - `discover` – A new peripheral has been discovered. The signature for the event handling function is `callback(peripheral)`.

### peripheral object

- `connect(callback)` – Connect to the peripheral. The signature of the callback function is `callback(error)`.
- `disconnect(callback)` – Disconnect a previously connected peripheral. The signature of the callback function is `callback(error)`.
- `discoverServices(uuids, callback)` – Ask the connected peripheral about its exposed services. The signature of the callback is `callback(error, services)`. The passed in array of `uuids` can be `null` to indicate that we wish all services to be returned.
- `discoverSomeServicesAndCharacteristics(serviceUids, characteristicUuids, callback)` – Discover some services and associated characteristics. The signature of the callback function is `callback(error, services, characteristics)`.
- `toString()` – Return a string representation of the peripheral.

### service object

- `discoverCharacteristics(characteristicUuids, callback)` – Ask the connected peripheral about the characteristics it exposes for a given service.

The signature of the callback is `callback(error, characteristics)`. The `characteristicUuids` passed in array can be null to return all the characteristics.

- `toString()` - Return a string representation of the service.
- **fields**
  - `uuid` – The uuid of the service. This is hex string of length 2, 4 or 16 hex bytes.
  - `name` – The name of the service (if known). For example "Generic Attribute".
  - `type` – The type of the service (if known). For example "org.bluetooth.service.generic\_attribute".

#### characteristic object

- `read(callback)` – Read the value of the characteristic and invoke a callback with the received data. The signature of the callback is `callback(error, data)`.
- `write(data, withoutResponse, callback)` – Write the value to the characteristic. We can define whether or not we want a response and, whether or not we want to be called back when the write completes. The data must be a Node.js `Buffer` instance.
- `subscribe(callback)` – Subscribe to notifications. The callback is invoked when subscription is now active.
- `unsubscribe(callback)` – Unsubscribe to notifications. The callback is invoked when we are unsubscribed.
- `discoverDescriptors(callback)` – Discover the descriptors associated with the characteristics. The signature of the callback is `callback(error, descriptors)`.
- **fields**
  - `uuid` – The uuid of the characteristic. This is hex string of length 2, 4 or 16 hex bytes.
  - `name` – The name of the characteristic (if known). For example "Device Name".
  - `type` – The type of the characteristic (if known). For example "org.bluetooth.characteristic.gap.device\_name".
  - `properties` – An array of string describing the properties exposed by this characteristic. These include:

- broadcast
- read
- write
- notify
- indicate

Here is a full sample application:

```

var noble = require("noble");
const name = "MYDEVICE";
const ESP32_SERVICE      = "4fafc2001fb5459e8fccc5c9c331914b";
const ESP32_CHARACTERISTIC = "4fafc2011fb5459e8fccc5c9c331914b";

noble.on("discover", function(Peripheral) {
  if (Peripheral.advertisement.localName == name ) {
    noble.stopScanning();
    Peripheral.connect((error) => {
      Peripheral.discoverServices([ESP32_SERVICE], (error, services) => {
        if (services.length > 0) {
          services[0].discoverCharacteristics([ESP32_CHARACTERISTIC], (error,
characteristics) => {
            if (characteristics.length > 0) {
              var characteristic = characteristics[0];
              characteristic.read((error, data) => {
                console.log("Here is the current value: " + data);
                var newValue = "Hello world: " + new Date().getTime();
                console.log("Changing to: " + newValue);
                characteristic.write(Buffer.from(newValue));
                Peripheral.disconnect();
              });
            }
          });
        }
      });
    });
  }
});

noble.on("stateChange", function(state) {
  if (state == "poweredOn") {
    noble.startScanning();
  }
});

```

See also:

- [npm: noble](#)
- [Github: sandeepmistry/noble](#)

## Using Bleno

The Bleno package provides the ability for us to create a Node.js based BLE server.

We start by installing the bleno package with:

```
$ npm install bleno
```

We can then start building our node.js applications. We will want to require bleno with:

```
var bleno = require("bleno");
```

We must not perform BLE work until we receive a `stateChange` event with value `poweredOn`. This is our indication that we are safe to continue. At this point we can start advertising.

To define the services on our device, we call `bleno.setServices()`.

We define a service definition using:

```
var myService = new bleno.PrimaryService({
  ... service definition
});
```

The service definition contains the following fields:

- `uuid` – The UUID of the service.
- `characteristics` – An array of characteristics for the service.

A characteristic is create with:

```
var myCharacteristic = new bleni.Characteristic({
  ... characteristic definition
});
```

The characteristic contains:

- `uuid` – The UUID of the characteristic.
- `properties` – The properties of the characteristic which is an array of strings which can be:
  - `read`
  - `write`
  - `writeWithoutResponse`
  - `notify`
  - `indicate`
- `secure`

- value
- descriptors
- onReadRequest – Function called when there is a read request.
- onWriteRequest – Function called when there is a write request.
- onSubscribe
- onUnsubscribe
- onNotify
- onIndicate

#### events

- stateChange
- advertisingStart
- advertisingStop
- advertisingStartError
- servicesSet
- servicesSetError
- accept
- disconnect
- rssiUpdate

See also:

- [npm: bleno](#)
- [Github: sandeepmistry/bleno](#)

## Bluetooth Audio

Bluetooth speakers and headphones are common so a natural question would be how to get sound out of them from the Pi. The answer is to install an application called PulseAudio.

```
$ sudo apt-get install pulseaudio pulseaudio-module-bluetooth
```

The Bluetooth profile we want to work with is called A2DP (Advanced Audio Distribution Profile).

## Bluetooth RFCOMM

A serial protocol is available via Bluetooth and is called "RFCOMM" for "Radio Frequency Communication".

When programming with C, we want to create a socket using:

```
int s = socket(AF_BLUETOOTH, SOCK_STREAM, BTPROTO_RFCOMM);
```

A socket address structure for Bluetooth RFCOMM is a struct called `sockaddr_rc` which contains:

- `sa_family rc_family` – This will always be `AF_BLUETOOTH`.
- `bdaddr_t rc_bdaddr` – The address of the device to which we wish to connect or listen upon. If any local Bluetooth adapter will suffice when we are a server, we can supply `BDADDR_ANY`.
- `uint8_t rc_channel` – The channel to which we wish to connect.

To be a client of an RFCOMM server, we would use:

```
#include <stdio.h>
#include <unistd.h>
#include <sys/socket.h>
#include <bluetooth/bluetooth.h>
#include <bluetooth/rfcomm.h>

int main(int argc, char *argv[])
{
    if (argc != 2) {
        printf("Usage: %s bdaddr\n", argv[0]);
        return 0;
    }

    struct sockaddr_rc addr = {0};
    int s, status;
    char *dest = argv[1];

    s = socket(AF_BLUETOOTH, SOCK_STREAM, BTPROTO_RFCOMM);

    addr.rc_family = AF_BLUETOOTH;
    addr.rc_channel = 1;
    str2ba(dest, &addr.rc_bdaddr);

    status = connect(s, (struct sockaddr *)&addr, sizeof(addr));
    if(status == 0) {
        status = send(s, "hello!", 6, 0);
    }

    if(status < 0) {
        perror("connect");
    }
}
```



```

close(s);
return 0;
}

```

**while to be a server we would use:**

```

#include <stdio.h>
#include <unistd.h>
#include <sys/socket.h>
#include <bluetooth/bluetooth.h>
#include <bluetooth/rfcomm.h>

int main(int argc, char **argv)
{
    struct sockaddr_rc loc_addr = { 0 }, rem_addr = { 0 };
    char buf[1024] = { 0 };
    int s, client, bytes_read;
    socklen_t opt = sizeof(rem_addr);

    // allocate socket
    s = socket(AF_BLUETOOTH, SOCK_STREAM, BTPROTO_RFCOMM);

    // bind socket to port 1 of the first available
    // local bluetooth adapter
    loc_addr.rc_family = AF_BLUETOOTH;
    loc_addr.rc_bdaddr = *BDADDR_ANY;
    loc_addr.rc_channel = (uint8_t) 1;
    bind(s, (struct sockaddr *)&loc_addr, sizeof(loc_addr));

    // put socket into listening mode
    listen(s, 1);

    // accept one connection
    client = accept(s, (struct sockaddr *)&rem_addr, &opt);

    ba2str(&rem_addr.rc_bdaddr, buf);
    fprintf(stderr, "accepted connection from %s\n", buf);
    memset(buf, 0, sizeof(buf));

    // read data from the client
    bytes_read = read(client, buf, sizeof(buf));
    if (bytes_read > 0) {
        printf("received [%s]\n", buf);
    }

    // close connection
    close(client);
    close(s);
    return 0;
}

```

**See also:**

- [RFCOMM with TS 07.10](#)
- [man\(1\) – rfcomm](#)
- [An Introduction to Bluetooth Programming](#)

## Bluetooth tools

### l2ping

In TCP/IP networking, we have a tool called ping which sends an ICMP packet over the network to which the partner responds. We can use this command to determine the "liveness" of the partner as well as get the round trip response times. For Bluetooth, we have a similar tool called "l2ping". This command sends a L2CAP echo request to the partner and waits for the response.

At the highest level, we use:

```
$ sudo l2ping <bd_addr>
```

where `bd_addr` is the address of the target device. Here is an example output:

```
$ sudo l2ping 00:1A:7D:DA:71:13
Ping: 00:1A:7D:DA:71:13 from B8:27:EB:62:03:9F (data size 44) ...
44 bytes from 00:1A:7D:DA:71:13 id 0 time 11.32ms
44 bytes from 00:1A:7D:DA:71:13 id 1 time 66.06ms
44 bytes from 00:1A:7D:DA:71:13 id 2 time 19.84ms
44 bytes from 00:1A:7D:DA:71:13 id 3 time 52.38ms
```

As of 05/2016, running the `l2ping` command on current Raspbian ends after about 5 seconds of pinging with a message:

```
Send failed: Connection reset by peer
```

Current thinking is that this is caused by a deliberate kernel timeout of L2CAP requests that don't result in a connection. The theory believed to be that to save battery life in real Bluetooth devices, if a connection isn't established in the timeout period, don't bother to keep trying and, presumably, waste power resources.

The `l2ping` command is delivered as part of the "`bluez`" package.

See also:

- [man\(1\) – l2ping](#)

### rfcomm

See also:

- [man\(1\) – rfcomm](#)

## bluetoothctl

One of the primary tools for working with Bluetooth is called `bluetoothctl`. Oddly, this command seems to have only the bare bones of a man page (shame).

One should run `bluetoothctl` as root using:

```
$ sudo bluetoothctl
```

If you fail to run it as root, it will just silently sit there until you interrupt it. This command line tool has the following commands:

- `list` – List available controllers
- `show [ctrl]` – Controller information
- `select <ctrl>` – Select default controller
- `devices` – List available devices
- `paired-devices` – List paired devices
- `power <on/off>` – Set controller power
- `pairable <on/off>` – Set controller pairable mode
- `discoverable <on/off>` – Set controller discoverable mode
- `agent <on/off/capability>` – Enable/disable agent with given capability
- `default-agent` – Set agent as the default one
- `advertize <on/off/capability>`
- `scan <on/off>` – Scan for devices
- `info <dev>` – Device information
- `pair <dev>` – Pair with device
- `trust <dev>` – Trust device
- `untrust <dev>` – Untrust device
- `block <dev>` – Block device
- `unblock <dev>` – Unblock device
- `remove <dev>` – Remove device
- `connect <dev>` – Connect device
- `disconnect <dev>` – Disconnect device
- `list-attributes <dev>` – List the attributes on the device.

- `set-alias <alias>`
- `select-attribute <attribute>`
- `attribute-info [attribute]`
- `read` – Read the value of the currently selected attribute.
- `write`
- `notify <on/off>` - Enable or disable notification for the currently selected attribute.
- `register-profile`
- `unregister-profile`
- `version` – Display version
- `quit` – Quit program

See also:

## hciconfig

As mentioned, HCI is the "Host-Controller Interface" which is the layer of communication between the higher level protocols of bluetooth and the bluetooth lower level controller. The "hciconfig" command allows us to execute commands through this logical interface.

Running `hciconfig` by itself will list all the bluetooth devices found on the computer:

```
$ hciconfig
hci0: Type: BR/EDR Bus: UART
      BD Address: B8:27:EB:62:03:9F ACL MTU: 1021:8 SCO MTU: 64:1
      UP RUNNING PSCAN
      RX bytes:19100 acl:150 sco:0 events:457 errors:0
      TX bytes:7952 acl:150 sco:0 commands:184 errors:0
```

Each bluetooth device has a logical identifier of the form "hciX" where the devices are numbered 0, 1, 2 ... etc.

To refer to a specific device, most of the commands that we issue through `hciconfig` will take the `hciX` device identifier to target the correct instance.

Some of the more interesting commands we can perform with `hciconfig` include:

- Getting and setting the devices display name property
- Enabling/disabling page support
- Enabling/disabling scan inquiry support

The `hciconfig` command is supplied as part of the "bluez" package.

Some useful commands include:

Start LE broadcasting connectable undirected advertising

```
$ sudo hciconfig hci0 leadv 0
```

Start LE broadcasting non-connectable undirected advertising

```
$ sudo hciconfig hci0 leadv 3
```

Stop LE broadcasting

```
$ sudo hciconfig hci0 noleadv
```

See also:

- `hcitool`
- [man\(8\) - hciconfig](#)

## hcidump

This tool is installed through:

```
$ sudo apt-get install bluez-hcidump
```

The tool appears to dump the commands sent through the host/controller interface.

Try running with:

```
$ sudo hcidump -x -R
```

to see low-level data.

## hcitool

The `hcitool` is delivered as part of the "bluez" package on Linux.

We can issue raw commands through the HCI using:

```
hcitool cmd <OGF> <OCF>
```

Where the combination of the two bytes <OGF> and <OCF> define the command to run. For LE controller commands, the <OGF> is 0x08.

To scan for bluetooth LE devices, use:

```
$ sudo hcitool lescan
```

We can start advertising packets. See BT Spec 4.2 Vol 2, Part E 7.8.7

Using:

```
$ sudo hcitool cmd 0x08 0x0008 <Length> <Content>
$ hciconfig hci0 leadv 0
```

### See also:

- [man\(1\) – hcitool](#)
- `hciconfig`

## gatttool

Interact with a BLE device at the GATT level. In order to interact with a BLE device at the gatt level, we need its device address. Using "`hcitool lescan`" is a good way to get the address. Typically the program is run with:

```
$ sudo gatttool --device=<Address> --interactive
```

This will return a command prompt that starts with the partner device address:

```
[FF:FF:45:19:14:80][LE]>
```

The sub-commands available to us include:

<code>connect</code>	<code>[address [address type]]</code>	Connect to a remote device
<code>disconnect</code>		Disconnect from a remote device
<code>primary</code>	<code>[UUID]</code>	Primary Service Discovery
<code>included</code>	<code>[start hnd [end hnd]]</code>	Find Included Services
<code>characteristics</code>	<code>[start hnd [end hnd [UUID]]]</code>	Characteristics Discovery
<code>char-desc</code>	<code>[start hnd] [end hnd]</code>	Characteristics Descriptor Discovery
<code>char-read-hnd</code>	<code>&lt;handle&gt;</code>	Characteristics Value/Descriptor Read
<code>by</code>		<code>handle</code>
<code>char-read-uuid</code>	<code>&lt;UUID&gt; [start hnd] [end hnd]</code>	Characteristics Value/Descriptor Read
<code>by UUID</code>		
<code>char-write-req</code>	<code>&lt;handle&gt; &lt;new value&gt;</code>	Characteristic Value Write (Write Request)
<code>char-write-cmd</code>	<code>&lt;handle&gt; &lt;new value&gt;</code>	Characteristic Value Write (No response)
<code>sec-level</code>	<code>[low   medium   high]</code>	Set security level. Default: low
<code>mtu</code>	<code>&lt;value&gt;</code>	Exchange MTU for GATT/ATT

Once connected, we can interrogate the device about its primary function by running the "primary" command:

```
[FF:FF:45:19:14:80][LE]> primary
attr handle: 0x0001, end grp handle: 0x0005 uuid: 00001800-0000-1000-8000-00805f9b34fb
attr handle: 0x0006, end grp handle: 0x0008 uuid: 0000180f-0000-1000-8000-00805f9b34fb
attr handle: 0x0009, end grp handle: 0x000b uuid: 00001802-0000-1000-8000-00805f9b34fb
attr handle: 0x000c, end grp handle: 0x000e uuid: 0000ffe0-0000-1000-8000-00805f9b34fb
```

Notice specifically the UUIDs. These correspond to the assigned numbers of the GATT specifications. Contrast this with the output of "`bluetoothctl info`" which shows the following:

```
[bluetooth]# info FF:FF:45:19:14:80
Device FF:FF:45:19:14:80
```

```
Alias: FF-FF-45-19-14-80
Appearance: 0x03c1
Icon: input-keyboard
Paired: no
Trusted: no
Blocked: no
Connected: yes
LegacyPairing: no
UUID: Generic Access Profile      (00001800-0000-1000-8000-00805f9b34fb)
UUID: Immediate Alert             (00001802-0000-1000-8000-00805f9b34fb)
UUID: Battery Service             (0000180f-0000-1000-8000-00805f9b34fb)
UUID: Unknown                     (0000ffe0-0000-1000-8000-00805f9b34fb)
```

For example, 0x...1802... is the Immediate [Alert service](#).

Looking back at the `gatttool` output, for each of the services, we see a "handle range". This describes the handles to the characteristics offered by that service. From the handles, we can ask the device what characteristics these represent:

```
[FF:FF:45:19:14:80][LE]> char-desc 0x0009 0x000b
handle: 0x0009, uuid: 00002800-0000-1000-8000-00805f9b34fb
handle: 0x000a, uuid: 00002803-0000-1000-8000-00805f9b34fb
handle: 0x000b, uuid: 00002a06-0000-1000-8000-00805f9b34fb
```

The UUIDs of the declarations and characteristics can then be examine in the assigned-numbers lists.

For example

- 0x...2800... – [GATT Primary Service Declaration](#)
- 0x...2803 ... – [GATT Characteristic Declaration](#)
- 0x...2A06... – [Alert Level](#)

See also:

- Bluetooth GATT
- [man\(1\) – gatttool](#)

## Bluetooth examples

### The iTag peripheral

The iTag is a cheap little thingy (\$2-\$4 on eBay) that is a bluetooth device. Its purpose is to form a connection with a bluetooth master. If the connection is subsequently lost, the device starts beeping. In addition, the device can receive a "ping" from the master to instruct it to immediately start beeping. In all these cases, it acts as a useful device to help you locate it should it get lost. Now imagine connecting it to your keys, pet, kid

or other loose-able thing and now we have a potential of either being notified that it is out of range or else it will beep to say "help me".



This makes a great device for testing the ESP32's ability to work as a BLE master.

If we run a BLE scan and listen for advertising packets, we will find that it shows up. From there we can get its bluetooth address. For example, when I ran an ESP32 to look for devices, the ESP32 found my tag with the address "FF:FF:45:14:80". Once the ESP32 found the address, I was the able to issue an open request to it which succeeded. Once I had an open connection, I issued a search request upon it and four services were returned. These were:

- UUID: 0x1800
- UUID: 0x1802
- UUID: 0x180f
- UUID: 0xffe0

Since these were 16bit UUIDs, that is the indication that they are specified by the bluetooth special interest group (SIG). A search at the GATT services web page found the first three:

- UUID: 0x1800 – [Generic Access](#)
- UUID: 0x1802 – [Immediate Alert](#)
- UUID: 0x180f – [Battery Service](#)

Great ... this is starting to make sense. Now we can drill down into the characteristics for each service. From the bluetooth specs, the characteristics possible are:

- UUID: 0x1800 – [Generic Access](#)
  - UUID: 0x2a00 – [Device Name](#)
  - UUID: 0x2a01 – [Appearance](#)
  - UUID: 0x2a02 – [Peripheral Privacy Flag](#)
  - UUID: 0x2a03 – [Reconnection Address](#)



- UUID: 0x2a04 – [Peripheral Preferred Connection Parameters](#)
- UUID: 0x1802 – [Immediate Alert](#)
  - UUID: 0x2a06 – [Alert Level](#)
- UUID: 0x180f – [Battery Service](#)
  - UUID: 0x2a19 – [Battery Level](#)

When we actually performed a characteristics query, what was returned were:

- UUID: 0x1800 – [Generic Access](#)
  - UUID: 0x2a00 – [Device Name](#)
  - UUID: 0x2a01 – [Appearance](#)
- UUID: 0x1802 – [Immediate Alert](#)
  - UUID: 0x2a06 – [Alert Level](#)
- UUID: 0x180f – [Battery Service](#)
  - UUID: 0x2a19 – [Battery Level](#)

Close enough to what we expected.

### Smart Watch / The TW64 Band

The TW64 watch/band can be found on eBay for about \$9. Performing an eBay search using "TW64" will turn up many.



We start by running a BLE scan:

```
$ sudo hcitool lescan
```

Which came back with:

```
LE Scan ...
A4:C1:38:77:1A:19 KeepBand
A4:C1:38:77:1A:19 (unknown)
```

And now we know the device address. Of course, each instance will vary.

next we can connect to the device and ask it about itself:

```
$ sudo gatttool --device=A4:C1:38:77:1A:19 --interactive
> connect
> primary
attr handle: 0x0001, end grp handle: 0x0007 uuid: 00001800-0000-1000-8000-00805f9b34fb
attr handle: 0x0008, end grp handle: 0x000b uuid: 00010203-0405-0607-0809-0a0b0c0d1911
attr handle: 0x000c, end grp handle: 0x0011 uuid: 66880000-0000-1000-8000-008012563489
```

and similarly, we can also run:

```
$ sudo bluetoothctl
# info A4:C1:38:77:1A:19
Device A4:C1:38:77:1A:19
  Name: KeepBand
  Alias: KeepBand
  Appearance: 0x0180
  Paired: no
  Trusted: no
  Blocked: no
  Connected: no
  LegacyPairing: no
  UUID: Human Interface Device (00001812-0000-1000-8000-00805f9b34fb)
  UUID: Battery Service (0000180f-0000-1000-8000-00805f9b34fb)
```

Interestingly, notice the distinction in services offered.

A search at the GATT services web page found:

- UUID: 0x1800 – [Generic Access](#)
- UUID: 0x180f – [Battery Service](#)
- UUID: 0x1812 – [Human Interface Device](#)

Again using gatttool, we can ask for the description of characteristics:

```
char-desc
handle: 0x0001, uuid: 00002800-0000-1000-8000-00805f9b34fb
handle: 0x0002, uuid: 00002803-0000-1000-8000-00805f9b34fb
handle: 0x0003, uuid: 00002a00-0000-1000-8000-00805f9b34fb
handle: 0x0004, uuid: 00002803-0000-1000-8000-00805f9b34fb
handle: 0x0005, uuid: 00002a01-0000-1000-8000-00805f9b34fb
handle: 0x0006, uuid: 00002803-0000-1000-8000-00805f9b34fb
handle: 0x0007, uuid: 00002a04-0000-1000-8000-00805f9b34fb
handle: 0x0008, uuid: 00002800-0000-1000-8000-00805f9b34fb
handle: 0x0009, uuid: 00002803-0000-1000-8000-00805f9b34fb
handle: 0x000a, uuid: 00010203-0405-0607-0809-0a0b0c0d2b12
handle: 0x000b, uuid: 00002901-0000-1000-8000-00805f9b34fb
```

```
handle: 0x000c, uuid: 00002800-0000-1000-8000-00805f9b34fb
handle: 0x000d, uuid: 00002803-0000-1000-8000-00805f9b34fb
handle: 0x000e, uuid: 66880001-0000-1000-8000-008012563489
handle: 0x000f, uuid: 00002803-0000-1000-8000-00805f9b34fb
handle: 0x0010, uuid: 66880002-0000-1000-8000-008012563489
handle: 0x0011, uuid: 00002902-0000-1000-8000-00805f9b34fb
```

## Web Bluetooth

Consider a browser. This is a software application that runs on your desktop or phone that retrieves web page descriptions from remote web servers and displays them. In addition, you can usually interact with those pages. This much we all know.

Now also consider that a browser can also download JavaScript which runs within the context of the browser. Typically, this JavaScript is client side code that works with the visualization of the browser to provide enhanced user interaction. Again, this we know.

But here is what may be new to you. There is a specification in the works that would allow a browser to interact with external Bluetooth devices that are in peripheral mode (i.e. being BLE servers). The browser would perform the role of the Bluetooth central. The JavaScript code running within the browser would then be able to connect to, read from and write to remote Bluetooth devices ... and since this code is dynamically downloaded as JavaScript from the Internet, we have effectively connected our BLE devices through to the Internet.

While interesting in principle, what practical use might we have for this capability?

First of all it allows the browser to perform a richer role as the UI presentation of your applications. We are continually finding that browsers are becoming the common denominator for many user interfaces. Many of these are internet enabled but just as many are what are known as "single page applications" and may be loaded from HTML and JavaScript that is local to where it is being executed. If the browser permits connection to a BLE device then now we can visualize data upon it or send new data to it.

Now let us look at how to use Web Bluetooth. At the highest level, calling `navigator.requestDevice()` returns a promise that resolves to an instance of a `BluetoothDevice`. A parameter to the `requestDevice()` call is an object of the form:

```
{
  filters:
  optionalServices:
  acceptAllDevices: <Boolean>
}
```

The structure seems to allow the following formats:

```
{
  filters: [
    {
      service: ["<UUID>"]
    }
  ]
}
```

or:

```
{
  filters: [
    {
      name: ["<DEVICE NAME>"]
    }
  ],
  optionalServices: ["<UUID>"]
}
```

or:

```
{
  acceptAllDevice: true,
  optionalServices: ["<UUID>"]
}
```

The Web Bluetooth specification allows for a browser to become a BLE Central component and hence form connections to BLE Peripherals. When accessing `navigator.bluetooth.requestDevice()`, this **must** be part of a user interaction (for example an explicit button press). This means that a user must explicitly and interactively choose to connect to a BLE device. An arbitrary piece of JavaScript downloaded in a web page does **not** have the capability to scan your BLE environment. This restriction is deliberate for security reasons.

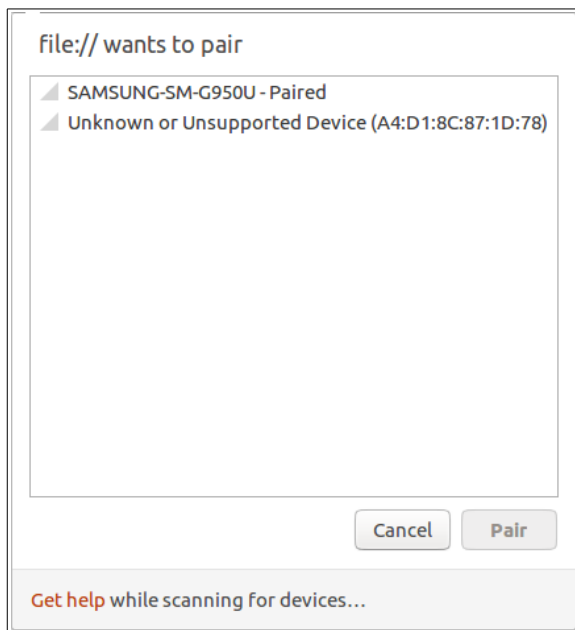

A dialog is then shown asking the user for permission to connect to a device assuming one or more are available.. The return from the `requestDevice()` call is an instance of `BluetoothDevice` which contains:

```
{
  id: <String> // An id for the device. Can be used for equality comparison.
  name: <String> // Human readable name for the device.
  gatt: <BluetoothRemoteGATTServer>
  ongattserverdisconnect: <function>
  <others>
}
```

Notice in particular the field called `gatt` that is an instance of `BluetoothRemoteGATTServer`.

The `BluetoothRemoteGATTServer` contains:

```
{
  device: <BluetoothDevice>,
  connected: <boolean>,
  connect: <function>, // Return a promise returning a BluetoothRemoteGATTServer
  disconnect: <function>,
  getPrimaryService: <function>, // Return a BluetoothRemoteGATTService
  getPrimaryServices: <function> // Return a promise for the remote GATT services
  (BluetoothRemoteGATTService) on this device. Must be connected first.
}
```

- `device` (`BluetoothDevice`) – Reference to the Bluetooth device.
- `connected` (`boolean`) – Are we connected to the GATT server?

- `connect (function)` – Connect to the GATT server.
- `disconnect (function)` – Disconnect from the GATT Server.
- `getPrimaryService (function)` – Get the primary service. The input to the function is a service UUID and the return is a `BluetoothRemoteGATTService`. Typically, the UUID has to be explicitly permitted in the `optionalServices` field of the `requestDevice ()` call.
- `getPrimaryServices (function)` – Get the array of primary services.

Notice the `connect ()` function. This allows us to connect from our browser to the BLE peripheral. When invoked, we will be returned a promise that returns a `BluetoothRemoteGATTServer`. Once done, we can start to work with the services.

A service is described by the `BluetoothRemoteGATTService` object.

```
{
  isPrimary: <Boolean>
  uuid: <String>
  getCharacteristic: <function>
  getCharacteristics: <function>
}
```

- `isPrimary (Boolean)` – True if this is a primary service.
- `uuid (String)` – UUID of the service.
- `getCharacteristic (function)` – A promise to return a `BluetoothGATTCharacteristic`. A UUID for a characteristic is required.
- `getCharacteristics (function)` – A promise to return an array of `BluetoothGATTCharacteristic`.

A characteristic is described by the `BluetoothRemoteGATTCharacteristic` object.

```
{
  oncharacteristicvaluechanged: <function>
  properties: <BluetoothCharacteristicProperties>
  service: <BluetoothRemoteGATTService>
  uuid: <String>
  value: <DataView>,
  getDescriptor: <function>
  getDescriptors: <function>
  readValue: <function>
  startNotifications: <function>
  stopNotifiications: <function>
  writeValue: <function>
}
```

- `oncharacteristicvaluechanged` (function) – A function that you can specify that will be invoked when the value of the characteristic is changed.
- `properties` (`BluetoothCharacteristicProperties`) – An object that defines the properties of this characteristic.
- `service` (`BluetoothRemoteGATTService`) – A reference to the service that owns this characteristic.
- `uuid` (UUID) – The UUID of this characteristic.
- `value` – The value ... may be null.
- `getDescriptor`
- `getDescriptors`
- `readValue` (function) – A function which, if available and called, will return a promise for a `DataView`. This `DataView` will contain the value of the characteristic.
- `startNotifications` (function) – Call to start notification events. Returns a promise.
- `stopNotifications` (function) – Call to stop notification events. Returns a promise.
- `writeValue`

The `BluetoothCharacteristicProperties` is an object that defines the core properties of the characteristic. It contains:

```
{
  authenticatedSignedWrite: <boolean>,
  broadcast:                <boolean>,
  indicate:                 <boolean>,
  notify:                   <boolean>,
  read:                     <boolean>,
  reliableWrites:           <boolean>,
  writeableAuxiliaries:     <boolean>,
  write:                     <boolean>,
  writeWithoutResponse:     <boolean>
}
```

- `authenticatedSignedWrites` (boolean)
- `broadcast` (boolean)
- `indicate` (boolean) – Can we be indicated of a value change?
- `notify` (boolean) – Can we be notified of a value change?

- `read (boolean)` – Can we read the value?
- `reliableWrites (boolean)`
- `writableAuxiliaries (boolean)`
- `write (boolean)` – Can we write the value?
- `writeWithoutResponse (boolean)`

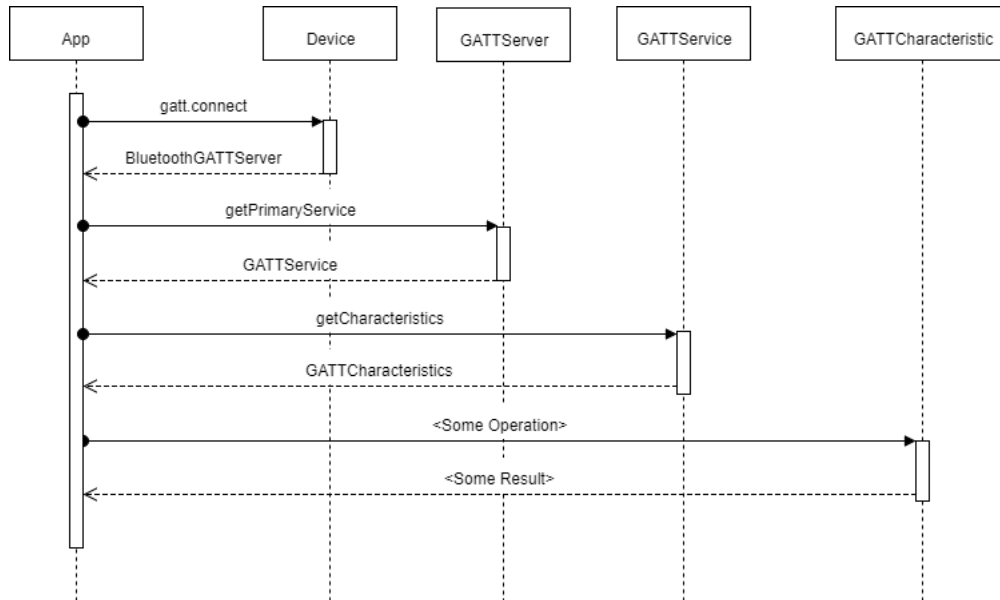

Once we have the `BluetoothRemoteGATTCharacteristic`, the fun can start.

First, we need to be cognizant of the values contained in the properties of this object. The properties declare what we are and are not permitted to do. For example, if the `read` property is true, then we are allowed to invoke `readValue()`. If the value of the property is false, then we may not invoke `readValue()`. Putting it simpler, just because there is a function that appears to be available, doesn't mean that we can sensibly invoke it.

We can register to be notified when a value changes:

```

var handlerFunc = function(event) {
    ...
}
characteristic.addEventListener("characteristicvaluechanged", handlerFunc);
  
```

The event object passed into the callback handler function has a `target` property which will be the instance of the `BluetoothRemoteGATTCharacteristic`. We can read the `value` property from this to get the current value. The `value` is an instance of a `DataView`. A



`DataView`  is a buffer of bytes from which we can read either bytes or numeric values. Should we want a string representation, the following is a useful little algorithm:

```
function DataViewToString(dataview) {
    var result = "";
    for (var i=dataview.byteOffset; i<dataview.byteLength; i++) {
        result += String.fromCharCode(dataview.getInt8(i));
    }
    return result;
}
```

To run a Web browser with Web Bluetooth on a Linux environment, some OS prerequisites are required including:

- Kernel 3.19+
- Bluez 5.41+

Both of these are satisfied with Ubuntu 17.04 or better.

In chrome, we can examine the Bluetooth information that is found using:

```
chrome://bluetooth-internals
```

We can start trace using:

```
google-chrome --enable-logging=stderr --vmodule=*bluetooth*=9 --enable-experimental-
web-platform-features
```

**Note:** When working with Web Bluetooth, the use of "arrow functions" and "promises" can come in very handy.

Imagine a place where a function reference might be supplied. For example:

```
function myFunction(functionRef) {
    functionRef(value);
}
```

In the above, the parameter to `myFunction` must itself be a function. A typical call might be:

```
myFunction(function(myValue) {
    // do something with myValue
});
```

The concept of the Arrow Function is an alternate declaration style. The equivalent to the above would be:

```
myFunction((myValue)=>{  
  // do something with myValue  
});
```

If there is only one parameter, we can shorten further by eliminating the parenthesis:

```
myFunction(myValue =>{  
  // do something with myValue  
});
```

See also:

- [Web Bluetooth Community](#)
- [Github: WebBluetoothCG/web-bluetooth](#)
- [Web Bluetooth Specification](#)
- [Interact with Bluetooth devices on the Web](#)
- [Google – Web-Bluetooth](#)
- [Logging Web Bluetooth – Chrome](#)
  
- [MDN – BluetoothDevice](#)
- [MDN – BluetoothRemoteGATTCharacteristic](#)
- [MDN – BluetoothRemoteGATTServer](#)
- [MDN – BluetoothRemoteGATTService](#)
- [MDN – DataView](#)
  
- [Arrow functions](#)

## The Physical Web

Have a mobile device browser "see" BLE devices that become available to launch web pages.

## BLE beacons

See also:

- [WikiPedia: iBeacon](#)
- [Getting started with iBeacon](#)
- [Understanding the different types of BLE Beacons](#)

## Hardware interfacing

When working with an ESP32 we will quickly recognize that it has a lot of capabilities for interacting with a variety of hardware devices. These may be through GPIO, SPI, I2C, Serial or other techniques. In this section we start to examine these distinct techniques and look at each one in turn.

To interface your ESP32 to hardware, you will be delving down into the hardware levels and attaching devices to the pins of your ESP32. Since there are many modules available, you will want to become familiar with the specifics of the modules you are working with as physical pin locations may differ from one manufacturer to another.

See also:

- Modules

## GPIOs

GPIO or General Purpose Input / Output is the ability to drive external pins of the ESP32 to a signal level of "1" or "0" under software application control. We can also choose to read the signal level that may be present on the pin as provided by an external component.

When we think of a GPIO we must realize that at any one time, each pin instance has two operational modes. It can either be in input mode or in output mode. When it is an input, we can read a value from it and determine the logic level of the signal present at the physical pin. When it is an output, we can write a logic level to it and that will appear as a physical output.

Another vital consideration when working with GPIOs is the voltage level. The ESP32 is a 3.3V device. You need to be extremely cautious if you are working with 5V (or above) external MCUs or sensors. Unfortunately devices like the Arduino are typically 5V as are USB → UART converters and many sensors. This means you are as likely as not to be working in a mixed voltage environment. Under **no** circumstances should you think you can power or connect to the ESP32 with a direct voltage of more than 3.3V. Obviously, you can convert higher voltages down to 3.3V but never try and directly connect a greater voltage. Another subtler consideration is when using GPIOs for signal input and supply greater than 3.3V as a high signal value. I strongly suggest not doing that. Some folks may claim you can "get away with it" and if you experiment it may (seem) to work but you are taking an unnecessary risk for no obviously good reason. If it works ... then it will work till it doesn't at which point it will be too late and you may cook your device.

It is also important to realize that the maximum amount of current you should anticipate drawing from an output GPIO is only 12mA.

Because accidents happen when building GPIO based circuits, I recommend buying more ESP32 instances than you need. That way if you do happen to find yourself needing a second (or third or fourth) you will have them at your disposal.

To use the GPIO functions supplied by the ESP-IDF, we must include the header file called "`driver/gpio.h`".

Next we must call `gpio_pad_select_gpio()` to specify that the function of a given pin should be that of GPIO as opposed to some other function.

There are 34 distinct GPIOs available on the ESP32. They are identified as:

- GPIO\_NUM\_0 – GPIO\_NUM\_19
- GPIO\_NUM\_21 – GPIO\_NUM\_23
- GPIO\_NUM\_25 – GPIO\_NUM\_27
- GPIO\_NUM\_32 – GPIO\_NUM\_39

The ones that are omitted are 20, 24, 28, 29, 30 and 31.

Note that GPIO\_NUM\_34 – GPIO\_NUM\_39 are input mode only. You can **not** use these pins for signal output. Also, pins 6 (SD\_CLK), 7 (SD\_DATA0), 8 (SD\_DATA1), 9 (SD\_DATA2), 10 (SD\_DATA3), 11 (SD\_CMD) 16 (CS) and 17(Q) are used to interact with the SPI flash chip ... you can **not** use those for other purposes.

When using pSRAM,

Strapping pins are GPIO0, GPIO2 and GPIO12.

TX and RX (as used for flash) are GPIO1 and GPIO3.

The data type called `gpio_num_t` is a C language enumeration with values corresponding to these names. It is recommended to use these values rather than attempt to use numeric values.

When we want to use a GPIO we need to be aware of whether we are using it as a signal input or a signal output. Think of this as the direction setting. We can set the direction with a call to `gpio_set_direction()`. For example, to set a pin as output we might call:

```
gpio_set_direction(GPIO_NUM_17, GPIO_MODE_OUTPUT);
```

while to set it as input we might call:

```
gpio_set_direction(GPIO_NUM_17, GPIO_MODE_INPUT);
```

If we have set our GPIO as output, we can now set its signal value to be either 1 or 0. We do that by calling `gpio_set_level()`.

Here is an example that toggles a GPIO on and off once a second:

```
gpio_pad_select_gpio(GPIO_NUM_17);
gpio_set_direction(GPIO_NUM_17, GPIO_MODE_OUTPUT);
while(1) {
    printf("Off\n");
    gpio_set_level(GPIO_NUM_17, 0);
    vTaskDelay(1000 / portTICK_RATE_MS);

    printf("On\n");
    gpio_set_level(GPIO_NUM_17, 1);
    vTaskDelay(1000 / portTICK_RATE_MS);
}
```

When we run this and examine the output on a logic analyzer, all is as desired:

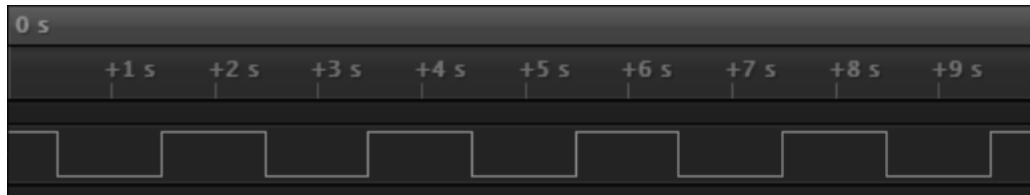

As an alternative to setting all the attributes of individual pins, we can set the attributes of one or more pins via a single call using the `gpio_config()` function. This takes a structure called `gpio_config_t` as input and sets the direction, pull up, pull down and interrupt settings of all the pins supplied in a bit mask. For example:

```
gpio_config_t gpioConfig;
gpioConfig.pin_bit_mask = (1 << 16) | (1 << 17);
gpioConfig.mode         = GPIO_MODE_OUTPUT;
gpioConfig.pull_up_en   = GPIO_PULLUP_DISABLE;
gpioConfig.pull_down_en = GPIO_PULLDOWN_ENABLE;
gpioConfig.intr_type    = GPIO_INTR_DISABLE;
gpio_config(&gpioConfig);
```

See also:

- `gpio_pad_select_gpio`
- `gpio_set_direction`
- `gpio_set_level`
- `gpio_config`

### Pull up and pull down settings

We commonly think of an input GPIO pin as having either a high or low signal supplied to it. This means that it is connected to +ve or ground. But what if it is connected to neither? In this case, the pin is considered to be in a floating state. There are times where we wish to define an unconnected pin as logically being high or low. An unconnected pin that is to be considered high is termed "pulled up" while an unconnected pin that is to be considered low is termed "pulled down". This comes from the physical hardware practice of attaching resistors to pull up or pull down the signal when it otherwise would be floating.

In the ESP32 SDK, we can define a GPIO as being pulled-up or pulled-down by using the `gpio_set_pull_mode()` function. This function takes as input the pin number we wish to set and the pull mode associated with that pin.

For example:

```
gpio_set_pull_mode(21, GPIO_PULLUP_ONLY);
```

See also:

- `gpio_set_pull_mode`

## GPIO Interrupt handling

If we consider that the signal on a pin can move from high to low or from low to high, such a change might be something our application would be interested in knowing. To determine when such a change happens, we can continually poll the pin value to detect a transition change. However this is not the best solution for a number of reasons. First, we have to busily perform checking to see whether a value has changed. This is a waste of cycles assuming the signal level does not change. Secondly, there will be a latency from the time the event happens to the time when we check. If we need to react immediately, we will be delayed by this latency. Thirdly, it is possible to completely miss a signal change if the duration of the change is short. For example, if we check the value of a pin and find it high and then immediately after checking it goes low and then high again, the next time we poll we will still see the pin high and never have known that it was ever low for a short period.

The solution to all these problems is the notion of an interrupt. An interrupt is similar to your doorbell at your house. Without a door bell (or listening for someone knocking) you would have to periodically check to see if there is anyone at the door. This wastes your time for the majority of instances where there is no-one there and also makes sure that, when there is someone there, you attend to them in a timely fashion.

In the land of ESP32s, we can define an interrupt callback function that will be called when a pin changes its signal value. We can also define what constitutes a reason for invoking the callback. We can configure the callback handler (technically called an interrupt handler) on a pin by pin basis.

First, let us consider the interrupt callback function. This is registered with a call to `gpio_isr_register()` which takes a callback handler that is invoked when an interrupt occurs on any GPIO pin (ISR = Interrupt Service Routine). Within the callback handler, we can then ask for the interrupt flag status with:

```
uint32_t gpio_intr_status = READ_PERI_REG(GPIO_STATUS_REG); // 0-31
uint32_t gpio_intr_status_h = READ_PERI_REG(GPIO_STATUS1_REG); // 31-39
```

Alternative, we can use the GPIO global variable which is a pre-mapped structure and access:

- `GPIO.status_w1tc` – Flags for GPIO0 to GPIO31
- `GPIO.status1_w1tc.val` – Flags for GPIO32 to GPIO39

We can enable or disable interrupt handling on a GPIO by GPIO basis by calling `gpio_intr_enable()`.

To enable an interrupt for a specific pin, we use the function called `gpio_set_intr_type()`. This allows us to set the reason that an interrupt might occur.

The reasons include:

- `Disable` – don't call an interrupt on a signal change.
- `PosEdge` – Call the interrupt handler on a change from low to high.

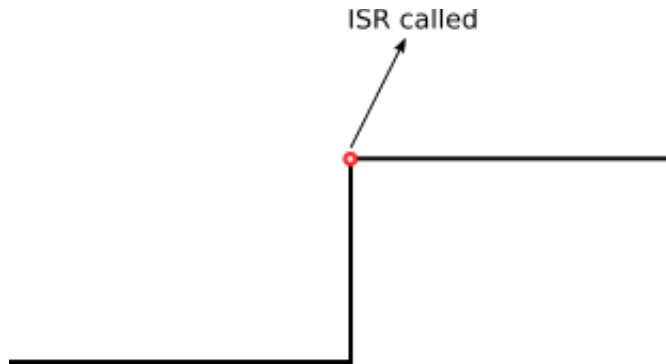

- `NegEdge` – Call the interrupt handler on a change from high to low.

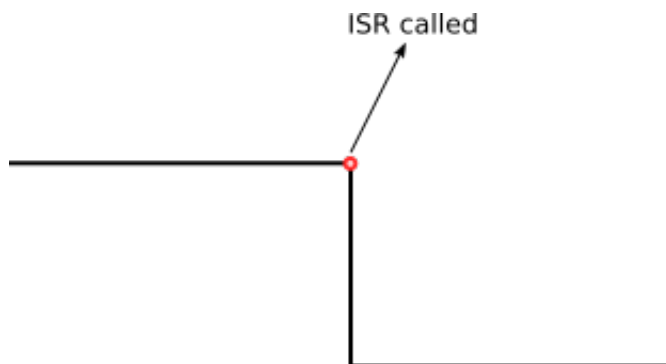

- `AnyEdge` – Call the interrupt handler on either a change from low to high or a change from high to low.

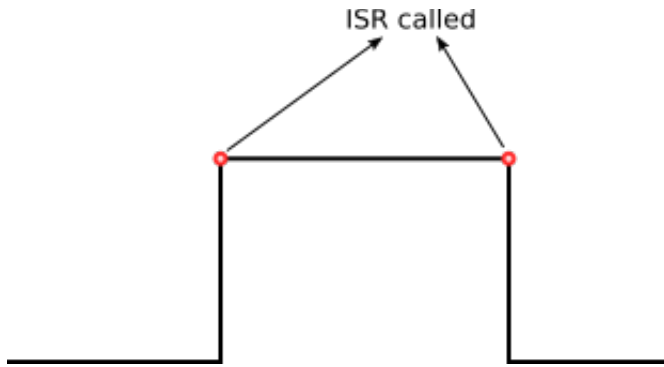

- Hi – Call the interrupt handler while the signal is high.
- Lo – Call the interrupt handler while the signal is low.

The interrupt handler can be flagged to be loaded into instruction RAM at compilation time. The default is that the generated code can live in flash. By flagging it up front as living in instruction RAM, it will always be there and ready to be immediately executed.

For example:

```
void IRAM_ATTR my_gpio_isr_handle(void *arg) {
    ...
}
```

A second implementation of interrupt handling is also provided that allows us to register a callback function associated with any given pin. This alleviates us from having to write switch code in a common interrupt handler to determine which pin causes us to be triggered. Think of it as a high level set of convenience functions.

Here is an example interrupt processor:

```
static char tag[] = "test_intr";
static QueueHandle_t q1;

#define TEST_GPIO (25)
static void handler(void *args) {
    gpio_num_t gpio;
    gpio = TEST_GPIO;
    xQueueSendToBackFromISR(q1, &gpio, NULL);
}

void test1_task(void *ignore) {
    ESP_LOGD(tag, ">> test1_task");
    gpio_num_t gpio;
    q1 = xQueueCreate(10, sizeof(gpio_num_t));

    gpio_config_t gpioConfig;
    gpioConfig.pin_bit_mask = GPIO_SEL_25;
    gpioConfig.mode          = GPIO_MODE_INPUT;
    gpioConfig.pull_up_en    = GPIO_PULLUP_DISABLE;
```



```

gpioConfig.pull_down_en = GPIO_PULLDOWN_ENABLE;
gpioConfig.intr_type    = GPIO_INTR_POSEDGE;
gpio_config(&gpioConfig);

gpio_install_isr_service(0);
gpio_isr_handler_add(TEST_GPIO, handler, NULL);
while(1) {
    ESP_LOGD(tag, "Waiting on queue");
    BaseType_t rc = xQueueReceive(q1, &gpio, portMAX_DELAY);
    ESP_LOGD(tag, "Woke from queue wait: %d", rc);
}
vTaskDelete(NULL);
}

```

### See also:

- [Interrupt Service Routines – ISRs](#)
- [gpio\\_install\\_isr\\_service](#)
- [gpio\\_isr\\_handler\\_add](#)
- [gpio\\_isr\\_handler\\_remove](#)
- [gpio\\_isr\\_register](#)
- [gpio\\_intr\\_enable](#)
- [gpio\\_intr\\_disable](#)
- [gpio\\_set\\_intr\\_type](#)
- [gpio\\_intr\\_enable](#)
- [gpio\\_intr\\_disable](#)

## Expanding the number of available GPIOs

Although the ESP devices only have a limited number of GPIO pins, that needn't be a restriction for us. We have the capability to expand the number of GPIOs available to us through some relatively inexpensive integrated circuits.

### PCF8574

One of the available GPIO expanders is called the PCF8574. (The PFC8574A is the same but has a different set of addresses).

This is an I<sup>2</sup>C device and hence works over only two wires. Using this IC we supply a 3 bit address (000-111) that is used to select the slave address of the device. Since each address has 8 IOs and we can have up to 8 devices, this means a total of 64 additional pins.

It appears that the device will use a pull-up resistor for a high and bring the pin to ground for low. This means that we can't use the pins for a high current source but can for low.

Here is the pin diagram for the device:

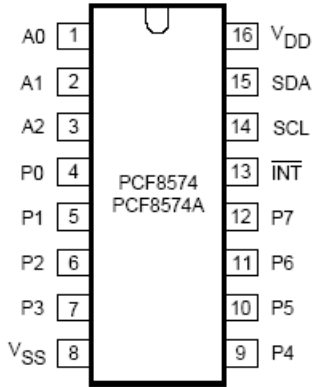

Here is a description of the pins:

Symbol	Pin	Description
A0-A2	1, 2, 3	Addressing
P0-P7	4, 5, 6, 7, 9, 10, 11, 12	Bi directional I/O
INT	13	Interrupt output
SCL	14	Serial Clock Line
SDA	15	Serial Data Line
V <sub>DD</sub>	16	Supply Voltage (2.5V – 6V)
V <sub>SS</sub> (Ground)	8	Ground

The address that the slave device can be found upon is configurable via the A<sub>0</sub>-A<sub>2</sub> pins. It appears at the following address:

PCF8574

0	1	0	0	A2	A1	A0
---	---	---	---	----	----	----

PCF8574A

0	1	1	1	A2	A1	A0
---	---	---	---	----	----	----

The pins A<sub>0</sub>-A<sub>2</sub> must not float.

This results in the following table:

A2	A1	A0	Address PCF8574	Address PCF8574A
0	0	0	0x20	0x38
0	0	1	0x21	0x39
0	1	0	0x22	0x3a
0	1	1	0x23	0x3b
1	0	0	0x24	0x3c
1	0	1	0x25	0x3d
1	1	0	0x26	0x3e
1	1	1	0x27	0x3f

Here is an Arduino example program that drives LEDs to create a Cylon effect.

```
#include <Wire.h>
#include <Ticker.h>
// SDA - Yellow - 4
// CLK - White - 5

#define SDA_PIN 4
#define CLK_PIN 5

Ticker ticker;
int counter = 0;
int dir = 1;

void timerCB() {
  Wire.beginTransmission(0x20);
  Wire.write(~((uint8_t)1<<counter));
  Wire.endTransmission();
  counter += dir;
  if (counter == 8) {
    counter = 6;
    dir = -1;
  } else if (counter == -1) {
    counter = 1;
    dir = 1;
  }
}

void setup()
{
  Wire.begin(SDA_PIN,CLK_PIN);
  ticker.attach(0.1, timerCB);
}

void loop()
```

{  
}

The corresponding circuit is:

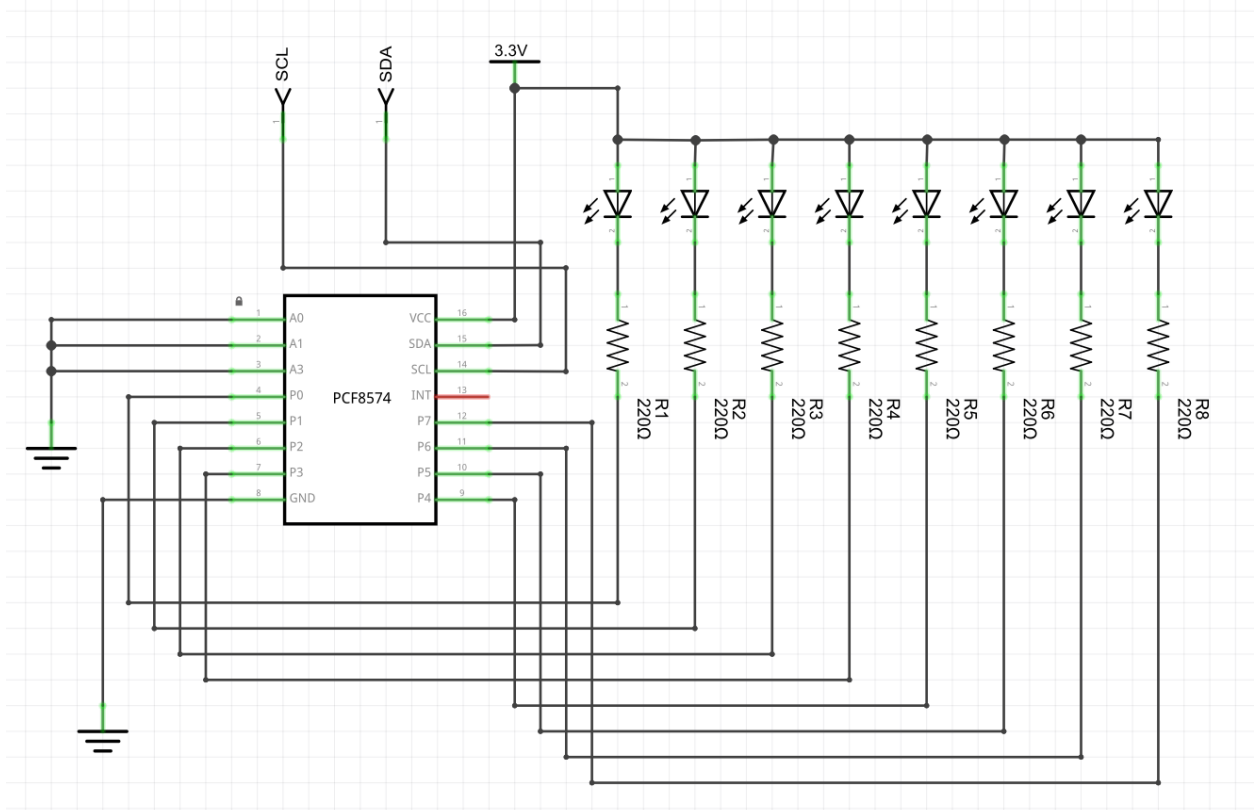

And on a breadboard:

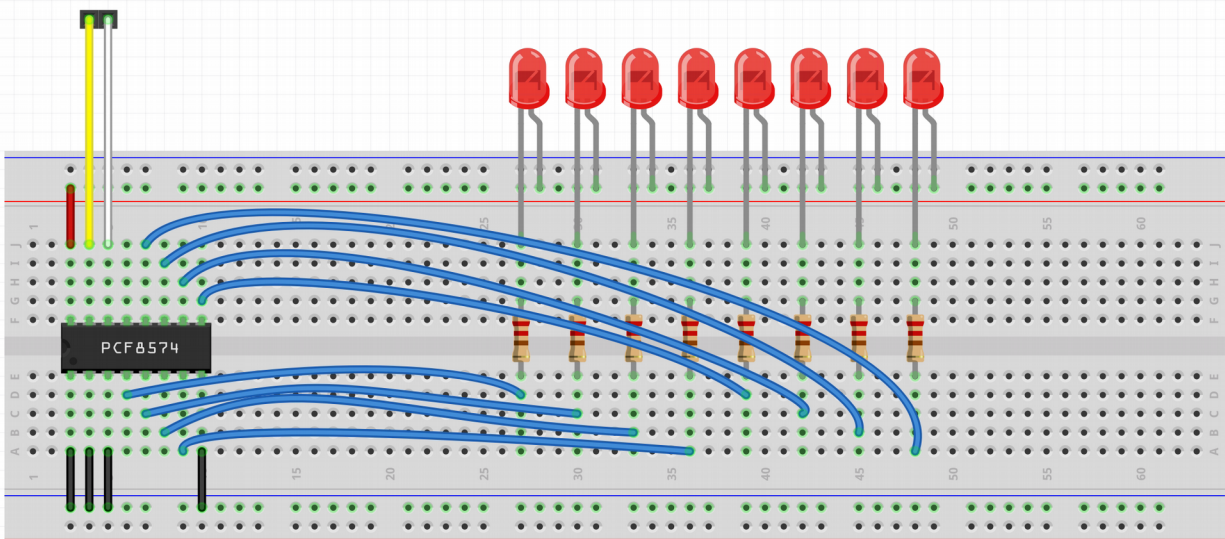

See also:

- [8BIT IO EXPANDER \(PCF8574\)](#)
- [Datasheet](#) – NXP
- [YouTube – ESP32 Technical Tutorial: PCF8574 GPIO Extender](#)
- [Product page](#) – TI
- Working with I2C

### PCF8575

The PCF8575 is a 16bit bi-directional port expander leveraging I2C.

The pin-outs are labeled:

INT	Interrupt
A0, A1, A2	Address selection
P00-P07	
P10-P17	
SCL	I2C clock
SDA	I2C data

The address that the slave device can be found upon is configurable via the  $A_0-A_2$  pins. It appears at the following address:

### PCF8575

0	1	0	0	A2	A1	A0
---	---	---	---	----	----	----

The pins  $A_0-A_2$  must not float.

This results in the following table:

A2	A1	A0	I2C Address PCF8575
0	0	0	0x20
0	0	1	0x21
0	1	0	0x22
0	1	1	0x23
1	0	0	0x24
1	0	1	0x25
1	1	0	0x26
1	1	1	0x27

See also:

- [Datasheet – NXP](#)

#### MCP23017

The MCP23017 from Microchip is a 16 bit input/output port expander that uses the I2C interface. The device can operate from 1.8V to 5.5V. The going price for an instance of one of these on eBay is about \$1. The device has 16 GPIO pins that can be set as input or output controlled in two banks (ports). We can read or write the values of one bank at a time meaning that if we want to write all 16 bits, this would be two I2C operations and the same for reading. The device is also capable of generating interrupts for input signal detection. If we imagine a 100KHz clock rate, then to switch a bit on or off (and we can do these in groups of 8) then that would be 3 bytes of data plus acknowledgments ... ~30 bits ... which would imply a maximum switching rate of about 0.3ms. The MCP23017 can operate at a variety of speeds including 100KHz and 400KHz.

The pin interface is:

Pin	Label	Description
1	GPB0	Bi-directional I/O
2	GBP1	Bi-directional I/O
3	GBP2	Bi-directional I/O
4	GBP3	Bi-directional I/O
5	GBP4	Bi-directional I/O
6	GBP5	Bi-directional I/O
7	GBP6	Bi-directional I/O
8	GBP7	Bi-directional I/O
9	VDD	Power (3.3V – 5V)
10	VSS	Ground
11	NC	Not connected
12	SCL	Serial clock input
13	SDA	Serial data input/output
14	NC	Not connected
15	A0	Address pin
16	A1	Address pin
17	A2	Address pin
18	RESET	Hardware reset
19	INTB	Interrupt output for port B
20	INTA	Interrupt output for port A
21	GPA0	Bi-directional I/O
22	GPA1	Bi-directional I/O
23	GPA2	Bi-directional I/O
24	GPA3	Bi-directional I/O
25	GPA4	Bi-directional I/O
26	GPA5	Bi-directional I/O
27	GPA6	Bi-directional I/O
28	GPA7	Bi-directional I/O

The I2C address of the device is 7 bits given by

<b>6</b>	<b>5</b>	<b>4</b>	<b>3</b>	<b>2</b>	<b>1</b>	<b>0</b>
0	1	0	0	A2	A1	A0

And hence has addresses in the range  $0x20 - 0x27$ .

The register addresses are:



Register address	Name	Description
0x00	IODIRA	Direction control for port A: <ul style="list-style-type: none"> <li>• 1 – input</li> <li>• 0 – output</li> </ul>
0x01	IODIRB	Direction control for port B: <ul style="list-style-type: none"> <li>• 1 – input</li> <li>• 0 – output</li> </ul>
0x02	IPOLA	Polarity inversion for input for port A: <ul style="list-style-type: none"> <li>• 1 – inverted</li> <li>• 0 – as-is</li> </ul>
0x03	IPOLB	Polarity inversion for input for port B: <ul style="list-style-type: none"> <li>• 1 – inverted</li> <li>• 0 – as-is</li> </ul>
0x04	GPINTENA	Interrupt enable for a change for port A: <ul style="list-style-type: none"> <li>• 1 – Enable input pin for interrupt on change event</li> <li>• 0 – Disable input pin for interrupt on change event</li> </ul>
0x05	GPINTENB	Interrupt enable for a change for port B: <ul style="list-style-type: none"> <li>• 1 – Enable input pin for interrupt on change event</li> <li>• 0 – Disable input pin for interrupt on change event</li> </ul>
0x06	DEFVALA	Default values for interrupt change comparison for port A.
0x07	DEFVALB	Default values for interrupt change comparison for port B.
0x08	INTCONA	Interrupt control for port A: <ul style="list-style-type: none"> <li>• 1 – Compare the value on the pin to the value in DEFVALA</li> <li>• 0 – Compare the value on the pin to its previous value</li> </ul>
0x09	INTCONB	Interrupt control for port B: <ul style="list-style-type: none"> <li>• 1 – Compare the value on the pin to the value in DEFVALB</li> <li>• 0 – Compare the value on the pin to its previous value</li> </ul>
0x0a	IOCON	Same register as 0x0b

		<b>Bit</b>	<b>Label</b>	<b>Description</b>
		7	BANK	Register mapping: <ul style="list-style-type: none"> <li>• Registers in banks</li> <li>• Registers sequential</li> </ul>
		6	MIRROR	Interrupt pin mapping: <ul style="list-style-type: none"> <li>• 1 – INT pins connected</li> <li>• 0 – INT pins separate. INTA is associated with port A and INTB is associated with port B</li> </ul>
		5	SEQOP	Sequential operation mode: <ul style="list-style-type: none"> <li>• 1 – Sequential operation disabled</li> <li>• 0 – Sequential operation enabled</li> </ul>
		4	DISSLW	Slew rate control
		3	HAEN	Hardware address enable
		2	ODR	Open drain output for INT
		1	INTPOL	Polarity of INT output: <ul style="list-style-type: none"> <li>• 1 – Active high</li> <li>• 0 – Active low</li> </ul>
		0	N/A	Not used. Set as 0.
0x0b	IOCON	Same register as 0x0a		
0x0c	GPPUA	Pull up control for Port A: <ul style="list-style-type: none"> <li>• 1 – Pull-up via a 100K resistor</li> <li>• 0 – Pull-up disabled</li> </ul>		
0x0d	GPPUB	Pull up control for Port B: <ul style="list-style-type: none"> <li>• 1 – Pull-up via a 100K resistor</li> <li>• 0 – Pull-up disabled</li> </ul>		
0x0e	INTFA	Interrupt flags for Port A: <ul style="list-style-type: none"> <li>• 1 – Pin caused an interrupt</li> <li>• 0 – No interrupt detected</li> </ul>		
0x0f	INTFB	Interrupt flags for Port B: <ul style="list-style-type: none"> <li>• 1 – Pin caused an interrupt</li> <li>• 0 – No interrupt detected</li> </ul>		
0x10	INTCAPA	Values of GPIO when interrupt occurred on port A: <ul style="list-style-type: none"> <li>• 1 – Pin was high</li> <li>• 0 – Pin was low</li> </ul>		
0x11	INTCAPB	Values of GPIO when interrupt occurred on port B: <ul style="list-style-type: none"> <li>• 1 – Pin was high</li> <li>• 0 – Pin was low</li> </ul>		
0x12	GPIOA	Read – Reads the values on port A		
0x13	GPIOB	Read – Reads the values on port B		
0x14	OLATA			
0x15	OLATB			

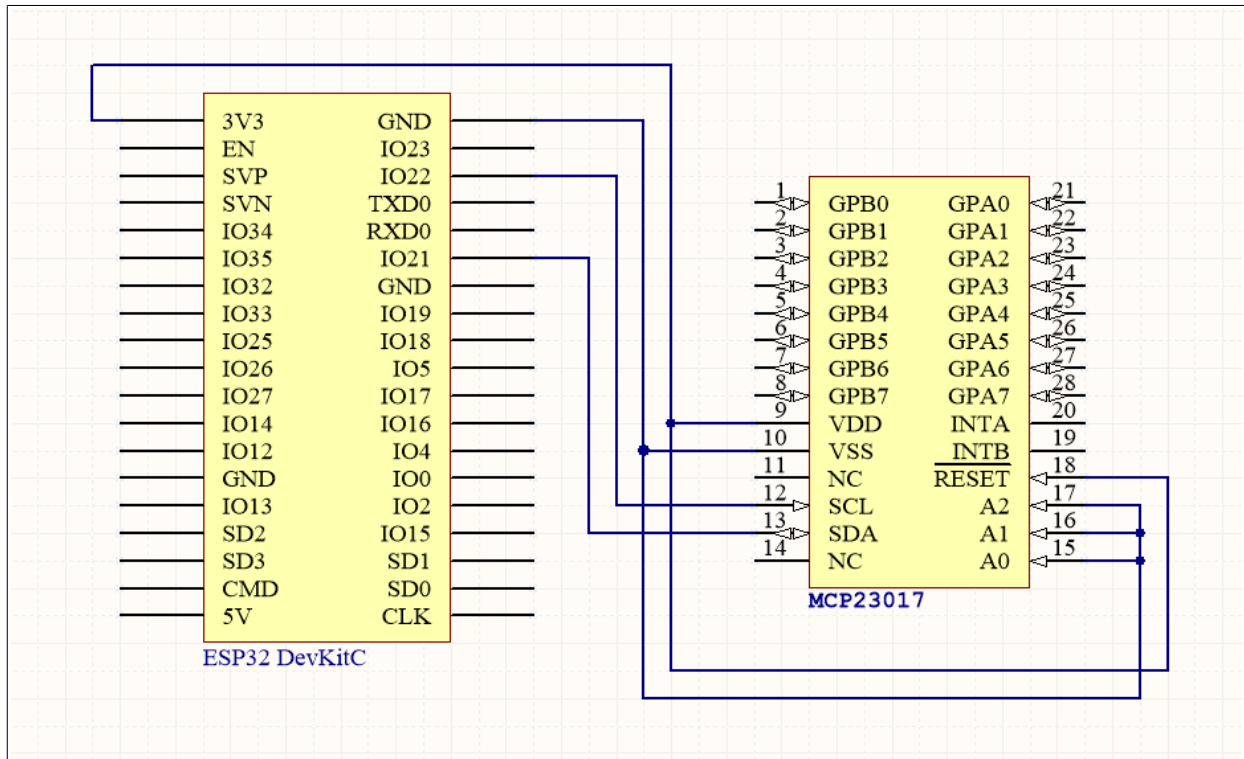

See also:

- [Data sheet](#)
- [Github: code fragment](#)
- [Github: telanoc/esp32\\_generic\\_i2c\\_rw](#)

## Interrupt Service Routines - ISRs

Imagine that you have written an ESP32 application in C. As you write that application, you make assumptions about what will happen. Imagine you write:

```
statement A;
statement B;
statement C;
```

Your assumption is that the program will perform statement A and then move on to statement B and then move on to statement C. In addition, if you have variables that are defined, unless the statements change those variables, you expect them to have the same values at the start as at the end. These are assumption that you should be able accept as true.

With an ESP32, we are programming a lot closer to the hardware than in some other environments. When working with hardware, events may happen externally to the ESP32 that require our attention. A GPIO might transition its signal level or a new network packet arrive or serial data appear. In each of these cases (and more) it might be necessary to interrupt what ever we may be currently doing at the time and handle that event. To achieve this, we have access to what are called "Interrupt Service Routines" or ISRs. These are commonly C functions that we provide as callbacks that may be invoked at almost anytime. They may be invoked between C statements or even during C statements. The state of the currently running program is saved and a "context switch" occurs causing the ISR to run. In order to maintain sanity, when you write an ISR there are rules that you absolutely must follow.

First an ISR must be as short as possible. Remember, when you jump into an ISR the ISR has no knowledge of what you were doing when the interrupt occurred. You may have been doing something that was time critical and you have to get back to as quickly as you can. You most certainly must never perform any activity which might be blocking.

Next, you must assume little about the state of the environment. You can't assume values of variables that you don't own and you absolutely must not change variable values that you don't own. Never mind being risky, trying to debug problems that show up only once in ever 1000 runs because the timing was "just right" is a nightmare to be avoided.

You should never invoke something that might result in another interrupt being generated. This can result in a never ending loop where an ISR causes an immediate interrupt which is processed when you return from the ISR which then goes on and on.

With these limitations in mind, what then can you do? The answer is to design a solution that correctly anticipates and handles interrupt requests. There is no single formula that fits all, but generally, if you can respond to the interrupt immediately with little or no side effects, then it is safe to do so. For example if an interrupt signals that a GPIO pin has changed value, you might update a memory location that is defined to reflect the "current" state of the pin and then immediately return. If you have to perform extended processing, then consider writing a message to a queue or unlocking a semaphore and then immediately returning. Since the ESP32 employs FreeRTOS which provides a preemptive task scheduler, you can have tasks that run in the background that "wake up" when events occur. These wake-ups need to be decoupled from the ISR and a queue or semaphore is a great way to achieve that. The following APIs are safe in ISR routines:

- `xTaskResumeFromISR()`
- `xTaskNotifyGiveFromISR()`

- xTaskNotifyAndQueryFromISR()
- xTaskNotifyFromISR()
- xQueueSendFromISR()
- xQueueSendToBackFromISR()
- xQueueSendToFrontFromISR()
- xQueueReceiveFromISR()
- uxQueueMessagesWaitingFromISR()
- xQueueOverwriteFromISR()
- xQueuePeekFromISR()
- xQueueIsQueueFullFromISR()
- xQueueIsQueueEmptyFromISR()
- xQueueSelectFromSetFromISR()
- xSemaphoreTakeFromISR()
- xSemaphoreGiveFromISR()
- xTimerStartFromISR()
- xTimerStopFromISR()
- xTimerChangePeriodFromISR()
- xTimerResetFromISR()
- xTimerPendFunctionCallFromISR()
- xEventGroupSetBitsFromISR()
- xEventGroupClearBitsFromISR()
- xEventGroupGetBitsFromISR()

## Working with I2C

The I2C interface is a technology for communications between electronics devices using a serial bus. It has two signal lines called SDA (Serial Data) and SCL (Serial Clock). The ESP32 can act as a master and the devices connected downstream act as slaves. Up to 127 distinct slaves are theoretically attachable. Each slave device has a unique address and the master decides which slave is to receive data or be allowed to

transmit next. In addition, the ESP32 can also be a slave device communicating with an external master.

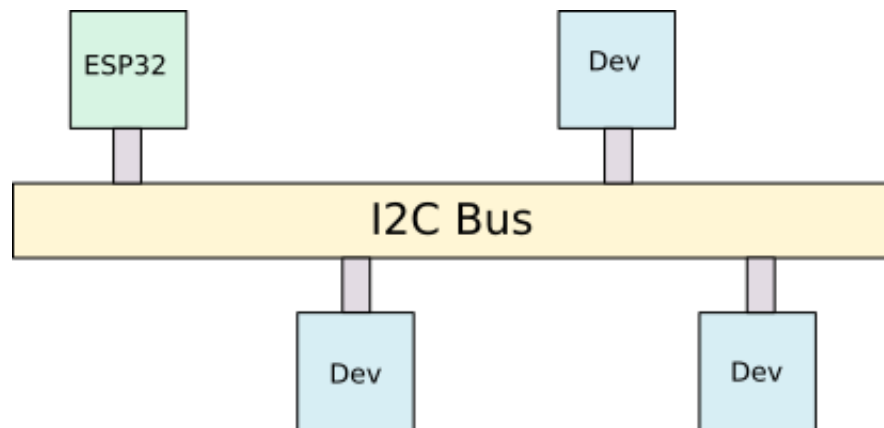

All the slaves connected use an "open drain" connection to the bus on their data lines. This means that when they connect, their attachment is either open circuit or ground as an output. Because of this it is impossible for there to be an electrical conflict as it would be impossible for one device to assert a high signal while another tried to assert a low signal. The presence of a logical high signal occurs when the currently selected slave device goes open circuit. This means that we need pull-up resistors on the lines such that when no-one is actively asserting a low signal, they are pulled-up to a logical high signal. A resistor value of 4.7K $\Omega$  is recommended.

The start of a transmission is indicated when the SCL is brought high and SDA is pulled low. This informs all the slave devices that an address is about to be transmitted by the master. When transmitted, the address is seen by all the slaves, but only one of them should match that address and the other devices must ignore the following request.

The address of a slave follows the initial start indication and is comprised of 7 bits with most significant bit first. Following the 7 bit address is a final 8<sup>th</sup> bit that indicates whether the master is requesting a read or a write request. A value of 1 indicates a read from the slave while a value of 0 indicates a write from the master.

On the SDA line, immediately after the 8 bits of address, comes the acknowledgment bit. This bit is **not** transmitted from the master to the slave but is instead transmitted from the slave to the master. Be sure you understand that notion as when looking at diagrams showing data on the SDA wire, those diagrams typically do not show the origination of the data, only their sequence. The turn around time from the last bit of the 8 bit address/direction data sent from the master to the acknowledgment bit sent from the slave happens without missing any clock cycles so has to be fast. A value of 0 in the acknowledgment states that the slave has received the data. A value of 1 in the acknowledgment states that no-one is responding or the slave is not present.

Following this addressing frame comes the data frame or frames. For a master write request, the master will send 8 bits of data and expect a single bit of acknowledgment. For a read from the slave, the slave will send 9 bits of data (8 data bits and an acknowledgment).

The master will finally send an end of communication (or stop) indication which is a transition to high on the clock with NO corresponding transition to low and **then** a transition from low to high on the SDA line.

See also:

- [I2C Bus](#)
- Sparkfun – [Tutorial: I2C](#)

### Using the ESP-IDF I2C driver

The ESP-IDF provides an I2C driver that allows us to control I2C functions from a C program at a high level without having to resort to low level register manipulation. Within the ESP32, the I2C functions are baked into the hardware of the ESP32 and the drivers make working with I2C significantly simpler. The ESP32 can provide the services of both an I2C master controller as well as the ability to be an I2C slave. There are two independent I2C ports so we can participate in two I2C buses simultaneously ... either as two masters, two slaves or one master and one slave. Or, obviously, if we only need one bus, we can just ignore the other. The two ports are named `I2C_NUM_0` and `I2C_NUM_1`. Before we can use an I2C port, we need to configure it.

In many ICs, the pin numbers used for I2C are fixed. This is not the case in the ESP32. Arbitrary exposed pins can be used for I2C. Since I2C is a "two wire" bus with one wire for clock and the other for data, for each I2C port we want to use we have to select two pins for these purposes. One pin will be the "`scl`" (clock) pin and the other will be the "`sda`" (data) pin.

To use I2C, we must configure the I2C environment. This involves a call to `i2c_param_config()`. This function takes two parameters. The first is the I2C port we are going to configure and the second is a structure containing the details of the configuration. Within this structure we have the following fields:

- `mode` – The mode that we are configuring this I2C port. This is where we define the I2C participation of the ESP32 as either a master or a slave. The choices we can supply here are either `I2C_MODE_MASTER` or `I2C_MODE_SLAVE`.
- `sda_io_num, scl_io_num` – These two fields define the pin number we will use for data and clock. Again, there are no fixed/pre-defined pin numbers.

- `sda_pullup_en`, `scl_pullup_en` – These two fields define whether the pins selected for data and clock will be pulled-up to a default of high.
- `clk_speed` – This field defines the clock speed of the bus when it is a master. A value of 100000 is normal for an I2C standard mode 100KHz bus but the ESP32 also supports the I2C fast mode 400KHz bus.

Here is an example:

```
i2c_config_t conf;
conf.mode          = I2C_MODE_MASTER;
conf.sda_io_num    = 25;
conf.scl_io_num    = 26;
conf.sda_pullup_en = GPIO_PULLUP_ENABLE;
conf.scl_pullup_en = GPIO_PULLUP_ENABLE;
conf.master.clk_speed = 100000;
i2c_param_config(I2C_NUM_0, &conf);
```

After we have configured how we want our I2C bus to behave, we can enable it by actually installing the driver. We do this with a call to `i2c_driver_install()`. When calling this function we name the port, whether we are a master or a slave and, if we are a slave what buffer sizes to use.

For example, when being a master:

```
i2c_driver_install(I2C_NUM_0, I2C_MODE_MASTER, 0, 0, 0);
```

Once we have initialized the I2C environment, we can now start thinking of the permutations of actions that we wish to perform. If we are an I2C master, then we can perform a write operation to an identified slave or perform a read operation to an identified slave.

First let us refresh ourselves on the notion of slave addresses. A slave address is typically 7 bits of address plus 1 bit flag of whether this is a read or write operation.

Address (7 bits)							Read or Write
Add 6	Add 5	Add 4	Add 3	Add 2	Add 1	Add 0	R/ $\overline{W}$

A read operation is a "1" and a write is a "0". These are defined as the constants `I2C_MASTER_READ` and `I2C_MASTER_WRITE` so we don't have to remember these values. If we want to read from a device at address `0x12` ... then our transmitted I2C address would be `(0x12 << 1) | I2C_MASTER_READ` while if we wished to write to a device at address `0x12`, our transmitted I2C address would be `(0x12 << 1) | I2C_MASTER_WRITE`.



To send a command, we build the structure of that command then ask for it to be transmitted. We start by creating a command handle using `i2c_cmd_link_create()`. Next we declare that the command starts with an I2C start request by calling `i2c_master_start(cmd)`. Now we can associate the data we wish to send with that command by calling `i2c_master_write_byte()` and/or `i2c_master_write()`. Next, we indicate that the command population has been completed. Now we can actually ask the ESP32 to perform the command with a call to `i2c_master_cmd_begin()`. This API causes all the commands buffered to be transmitted. After calling `i2c_master_cmd_begin()`, we should release the command handle and create a new one for the next transmission.

Here are some examples. Imagine we want to send the byte `0x34` to the slave at address `0x12`:

```
i2c_cmd_handle_t cmd = i2c_cmd_link_create();
i2c_master_start(cmd);
i2c_master_write_byte(cmd, (0x12 << 1) | I2C_MASTER_WRITE, 1 /* expect ack */);
i2c_master_write_byte(cmd, 0x34, 1);
i2c_master_stop(cmd);
i2c_master_cmd_begin(I2C_NUM_0, cmd, 1000/portTICK_PERIOD_MS);
i2c_cmd_link_delete(cmd);
```

When working with I2C, I recommend that once you have attached the devices to your I2C bus run an I2C scanner to ensure that they are responding properly. If we think about an I2C slave devices, when the master starts a transaction and transmits the address of the slave, the slave will respond with a positive acknowledgment ... assuming it is present to respond. If there is no such slave with that address, there obviously won't be such a response. As such, if we walk through each of the possible I2C addresses and start a transaction merely to see if we get a response, we can build a map of which slaves are present and which are not. An example ESP-IDF program that just does that can be found here:

<https://github.com/nkolban/esp32-snippets/blob/master/i2c/scanner/i2cscanner.c>

An example output might be:

```
      0  1  2  3  4  5  6  7  8  9  a  b  c  d  e  f
00:      -- -- -- -- -- -- -- -- -- -- -- -- -- --
10: -- -- -- -- -- -- -- -- -- -- -- -- -- -- --
20: 20 -- -- -- -- -- -- -- -- -- -- -- -- -- --
30: -- -- -- -- -- -- -- -- -- -- -- -- -- -- --
40: -- -- -- -- -- -- -- -- -- -- -- -- -- -- --
50: -- -- -- -- -- -- -- -- -- -- -- -- -- -- --
60: -- -- -- -- -- -- -- -- -- -- -- -- -- -- --
70: -- -- -- -- -- -- -- -- -- --
```

See also:

- `i2c_cmd_link_create`
- `i2c_cmd_link_delete`
- `i2c_master_start`
- `i2c_master_stop`
- `i2c_master_cmd_begin`
- `i2c_master_write`
- `i2c_master_write_byte`
- `i2c_driver_install`
- `i2c_param_config`
- [ESP32 Documentation: I2C](#)

## Common I2C devices

The following is a partial list of some of the more popular I2C based devices.

Device	Description	Address
ADS1015	Analog to Digital	
DS1307	Real Time Clock	0x68
BH1750FVI	Light level sensor	0x23
HMC5883L	Compass	0x1E
MCP4725	Digital to Analog	
MCP23017	GPIO extender	0x20-0x27
MPU6050	Accelerometer / Gyroscope	0x68
MPU6500	Accelerometer / Gyroscope	
MPU9255	Accelerometer / Gyroscope / Compass	
PCA9685	PWM controller	
PCF8574	GPIO extender	0x20-0x27
TEA5767	FM Radio	

See also:

- Compass – HMC5883L (aka GY-271) (aka CJ-M49)
- Ambient light level sensor – BH1750FVI
- MCP23017
- Accelerometer and Gyroscope – MPU-6050 (aka GY-521)
- Real time clocks

## Working with SPI - Serial Peripheral Interface

SPI is a bus protocol that will allow an ESP32 to communicate with peripheral devices or integrated circuits that comply with the SPI protocol. Logically, it looks as follows:

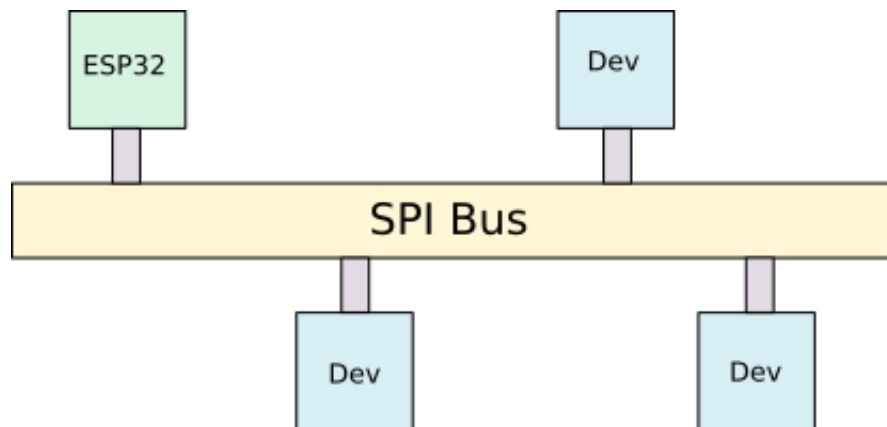

Within the protocol, one device (typically the ESP32) acts as the bus "master" and all the other devices act as bus "slaves". What this means is that the communication is between the master and one individual slave at a time. The slave devices don't communicate with each other. The purpose of a bus is that we can attach multiple devices to the ESP32 (the master) using only a few wires as opposed to having to have multiple wires out to each individual device.

Within the SPI protocol there are primarily three connections (wires) to each device.

The first is called the "clock" line. This is an outbound signal from the master which is used to synchronize activities between all the participants. It is usually a regular high/low equally spaced train of signals. The frequency of the clock defines the speed of transmission across the bus. When the clock transitions from high to low or low to high, this is an indication in the SPI protocol that the slave device should send and receive data.

The next line we will look at is a data line that is exclusively written by the master and read by the slaves. The line is called the "Master Out / Slave In" which is an excellent description of its purpose. Commonly this is abbreviated to MOSI. The master serially streams data outbound down this line and the slave receives the data. The data bits on the line are synchronized with the clock line so that the slave knows when the next bit is ready to be read.

The third line is also a data line that is exclusively written by a slave and read by the master. The line is intelligently called "Master In / Slave Out" and abbreviated to "MISO". Again, the clock line is used to indicate when the slave should transition its output bits.

If there were only one device to which the master were communicating, these three lines would be sufficient ... however that isn't much of a bus. If we have multiple

devices, the obvious problem is how does one slave know that it is being talked to as opposed to some potentially distinct slave? The answer is that each slave has a unique input line called the "Slave Select" (SS). Normally the slave select has one value (eg. high) and only when the master drives the slave select to the other value (eg. low) does that slave know that it is being addressed. The rules state that a slave should only respond (receive or transmit) on the bus when its slave select line indicates that it is to do so.

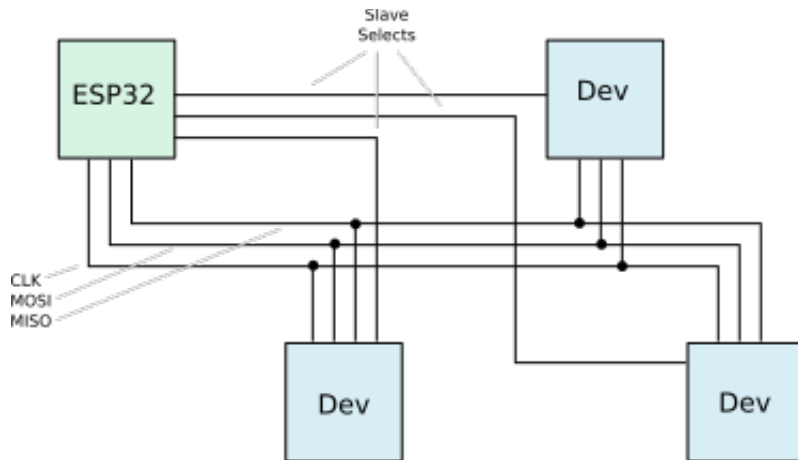

While a device is active because it is selected by the master, it can simultaneously read data from the MOSI line while concurrently writing data to the master through the MISO line. Focusing on a single master/slave interaction, the story looks like:

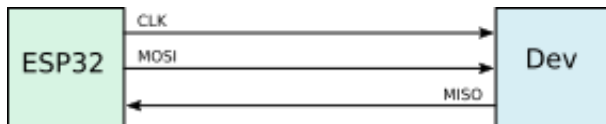

Since this is a serial protocol and we will receive data in bytes, we need to be cognizant of whether or not data will arrive LSB first or MSB first. There will be an option to control this.

For the clock, we will be latching data and we will need to know what edges and settings are important. There will be a clock mode option to control this. In SPI there are two attributes called phase and polarity. Phase ( $CPHA$ ) is whether we are latching data on high or low and Polarity ( $CPOL$ ) is whether high or low means that the clock is idle.

$CPOL=0$  means clock is default low,  $CPOL=1$  means clock is default high.

When  $CPOL=0$ , then the following are the values for  $CPHA$ :

$CPHA=0$  means data is captured on clock rising edge,  $CPHA=1$  means data is captured on clock falling edge.

When  $CPOL=1$ , then the following are the values for  $CPHA$ :

$CPHA=0$  means data is captured on clock falling edge,  $CPHA=1$  means data is captured on clock rising edge.

SPI wraps these two flags into four defined and named modes:

Mode	Clock Polarity – CPOL	Clock Phase – CPHA
SPI_MODE0	0 (Clock default low)	0
SPI_MODE1	0 (Clock default low)	1
SPI_MODE2	1 (Clock default high)	0
SPI_MODE3	1 (Clock default high)	1

The default for most purposes will be `MODE0`.

Also for the clock, what speed are we will need to know what speed the data is to be moved. There will be a clock control speed option to control this.

See also:

- [Sparkfun: Serial Peripheral Interface \(SPI\)](#)
- [Wikipedia: Serial Peripheral Interface Bus](#)

### Using the ESP-IDF SPI driver

Unlike other devices and processors on the market, the ESP32 doesn't dictate that a fixed set of pins **must** be used for the CLK, MOSI and MISO functions. Instead the pins that you select within your application will perform these functions. Should you be designing PCBs this opens up many more levels of flexibility as it simplifies connectivity and link routing.

Because the ESP32 doesn't limit you to just one SPI bus, the utilization of SPI on ESP32 is architected into a set of discrete steps.

1. We initialize a bus defining its nature.
2. We describe a device to the ESP32 that is attached to a configured bus. From this we get a handle that refers to that device.
3. We communicate with a device using its handle reference.

We use the notion of a transaction to describe the ESP32 interacting as a master with a slave peripheral.

We can imagine there being the following actions performed:

- A command is sent
- An address is sent
- Data is read from the slave and simultaneously data is written to the slave

The command and address actions are optional and can be omitted resulting in only the parallel send and receive of data.

The following illustrates the relationships between some of the logical components we will be working with from an SPI driver perspective. The Bus definition identifies the pins used for a bus for MOSI, MISO and CLK. Next we define a logical device and the characteristics of that device on the bus. Notice that the clock speed of the bus is an attribute of the device definition. When I first tried to understand this it confused me. Surely a bus has a clock speed that is the same for all devices? In the ESP32 we have more flexibility than ever before. The ESP32 can communicate with distinct devices using different bus speeds as a function of the currently selected device. For example, if we are talking with device "A", we may use a clock speed of 100KHz however if we are talking with device "B", we can use a different clock speed. Since only one device at a time is active because of its slave selection, the other devices can ignore the clock rate (and other data lines) and hence speed of clock is not a consideration for a device that is not selected.

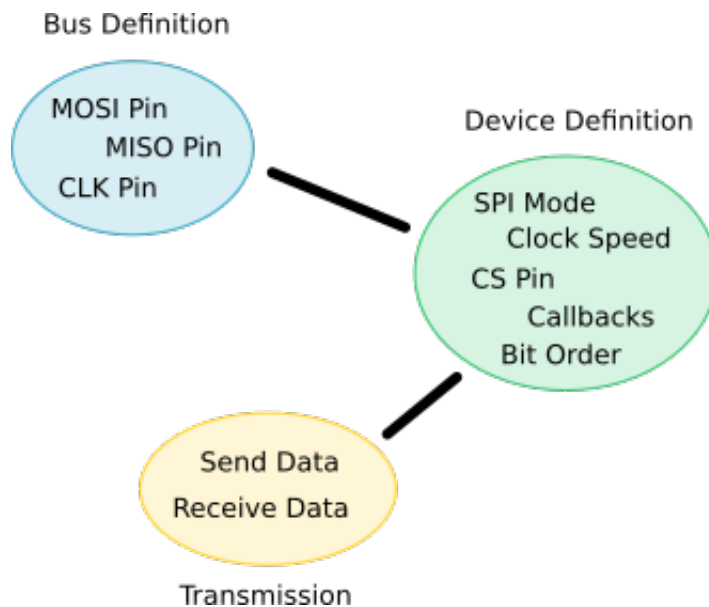

To use the SPI driver, we start by calling `spi_bus_initialize()`. Here we identify the pins on the ESP32 that are to be used for SPI functions such as CLK, MISO and MOSI.

Next we call `spi_bus_add_device()` to tell the ESP32 about an external SPI device. This includes optionally nominating a pin for the slave selection (CS) as well as a clock speed for communications with that device. Calling `spi_bus_add_device()` populates a handle for us that we can subsequently use to refer to that device.

Once done, the ESP32 and external SPI device have a relationship and it is now possible for them to interact. We can either queue transactions using the call to `spi_device_queue_trans()` and subsequently query their results with a call to `spi_device_get_trans_result()` or we can synchronously interact with the SPI device using a call to `spi_device_transmit()`.

Putting this all together, here is a sample that transmits a few bytes over a bus:

```
#include <driver/spi_master.h>
void test_spi_task(void *ignore) {
    ESP_LOGD(tag, ">> test_spi_task");

    spi_bus_config_t bus_config;
    bus_config.sclk_io_num    = clkPin; // CLK
    bus_config.mosi_io_num    = mosiPin; // MOSI
    bus_config.miso_io_num    = misoPin; // MISO
    bus_config.quadwp_io_num = -1; // Not used
    bus_config.quadhd_io_num = -1; // Not used
    ESP_LOGI(tag, "... Initializing bus.");
    ESP_ERROR_CHECK(spi_bus_initialize(HSPI_HOST, &bus_config, 1));

    spi_device_handle_t handle;
    spi_device_interface_config_t dev_config;
    dev_config.address_bits    = 0;
    dev_config.command_bits    = 0;
    dev_config.dummy_bits      = 0;
    dev_config.mode             = 0;
    dev_config.duty_cycle_pos   = 0;
    dev_config.cs_ena_posttrans = 0;
    dev_config.cs_ena_pretrans = 0;
    dev_config.clock_speed_hz  = 10000;
    dev_config.spics_io_num     = csPin;
    dev_config.flags            = 0;
    dev_config.queue_size       = 1;
    dev_config.pre_cb           = NULL;
    dev_config.post_cb          = NULL;
    ESP_LOGI(tag, "... Adding device bus.");
    ESP_ERROR_CHECK(spi_bus_add_device(HSPI_HOST, &dev_config, &handle));

    char data[3];
```

```

spi_transaction_t trans_desc;
trans_desc.address = 0;
trans_desc.command = 0;
trans_desc.flags = 0;
trans_desc.length = 3 * 8;
trans_desc.rxlenght = 0;
trans_desc.tx_buffer = data;
trans_desc.rx_buffer = data;

data[0] = 0x12;
data[1] = 0x34;
data[2] = 0x56;

ESP_LOGI(tag, "... Transmitting.");
ESP_ERROR_CHECK(spi_device_transmit(handle, &trans_desc));

ESP_LOGI(tag, "... Removing device.");
ESP_ERROR_CHECK(spi_bus_remove_device(handle));

ESP_LOGI(tag, "... Freeing bus.");
ESP_ERROR_CHECK(spi_bus_free(HSPI_HOST));

ESP_LOGD(tag, "<< test_spi_task");
vTaskDelete(NULL);
}

```

If we then examine the result in the output of a logic analyzer we find:

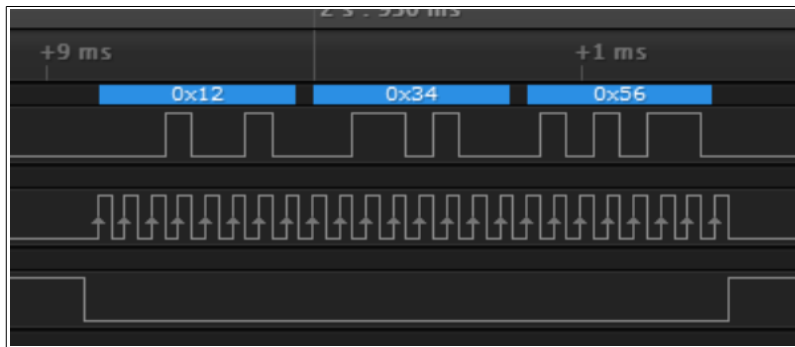

See also:

- [spi\\_bus\\_initialize](#)
- [spi\\_bus\\_add\\_device](#)
- [spi\\_device\\_transmit](#)
- [spi\\_device\\_queue\\_trans](#)
- [spi\\_device\\_get\\_trans\\_result](#)



## The Arduino Hardware Abstraction Layer SPI

The Arduino hardware abstraction layer for SPI provides a high level API for working with SPI. On an ESP32 there are multiple SPI peripherals so we need to always identify which one we are working with. The identity of an SPI instance is contained within an "spi\_t" instance. We get a pointer to one of these by calling "spiStartBus".

The pins on an ESP32 that can be used for SPI can be dynamically mapped.

Remember that a single SPI instance can have up to 4 pins ... these are `SCK`, `MOSI`, `MISO` and `SS`. For the three SPI interfaces supplied by ESP32, the following are suggestions with native support:

SPI	MOSI	MISO	CLK	SS
HSPI	13	12	14	15
VSPI	23	19	18	5
FSPI	8	7	6	11

Of these three, the `FSPI` bus should **not** be used for applications as it is used internally by ESP32.

The following diagram illustrates the default pin numbers for SPI for `VSPI` and `HSPI` ... but please realize that these are only defaults and can be re-mapped as needed.

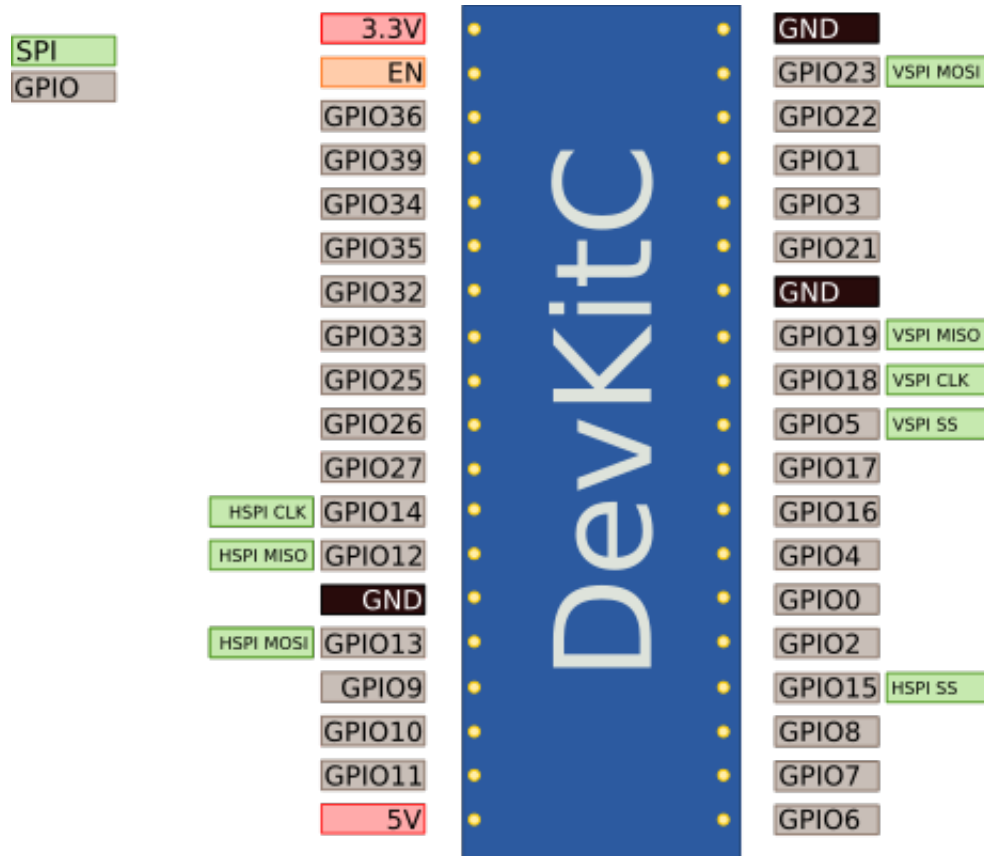

Once we have the SPI instance, we call `spiAttachMOSI()`, `spiAttachMISO()`, `spiAttachCLK()` and `spiAttachSS()` to set the corresponding pin mappings. Passing a pin value of -1 uses the default otherwise the explicit pin number supplied is used.

Once we have an SPI instance and attached the pins, we can start sending and receiving data.

```
spi_t *spi = spiStartBus(VSPI, 1000000, SPI_MODE0, SPI_MSBFIRST);
spiAttachSCK(spi, sckPin);
spiAttachMISO(spi, misoPin);
spiAttachMOSI(spi, mosiPin);
spiAttachSS(spi, 0, ssPin); //if you want hardware SS
spiEnableSSPins(spi, 1 << 0); //activate SS for CS0
spiSSEnable(spi);

//transfer some data
const char * data = "hello spi";
uint8_t out[strlen(data)];
spiTransferBytes(spi, (uint8_t *)data, out, strlen(data));
//out now contains the response from the slave
```

See also:

- `spiStartBus`

- spiAttachMISO
- spiAttachMOSI
- spiAttachSCK
- spiAttachSS

## Common SPI devices

Now that we know about the existence of SPI, we might ask ourselves what kinds of peripheral devices are available for use? Here is a short list of some of the more interesting ones I have come across:

Device	Description
MAX7219/MAX7221	7 segment or 8x8 matrix LED controller.
MCP3208	12 bit Analog to Digital
Nokia 5110 / PCD8544	84x48 pixel LCD
SSD1306	128x64 OLED display
ST7735	128x128 display
TJCTM24024-SPI	320x240 TFT display
MFRC522	RFID
nRF24L01	Communications device

## Working with UART/serial

The goal of a data bus is to move information from one place to another. In our digital electronics world, the unit of information is a bit ... a value of 1 or 0. Typically we group these bits into a larger unit called a byte which a sequence 8 bits. These 8 bits can be used to represent a numeric value from 0 to 255.

Now let us suppose we have a CPU (eg. an ESP32) and a remote device which wants a piece of data that the ESP32 has. For example, we'll keep it simple, assume it is some kind of smart light bulb where a value of 0 means dark and a value of 255 means full luminescence. How do we transmit our data from the ESP32 to the device? One way would be to have 8 parallel wires between the ESP32 and the device and we would simultaneously set each of the digital values on the wires to the 8 bits of our value. That works great ... but it has two draw backs. The first is that it means that we have to use thick cables carrying 8 separate discrete strands. It also limits us to only 8 bits of data. What if we want to send 24 bits of data such as the luminescence for red, green and blue?

The data bus we are considering here is known as a parallel bus because we are sending data in parallel. However in our story, we are going to talk about a serial bus.

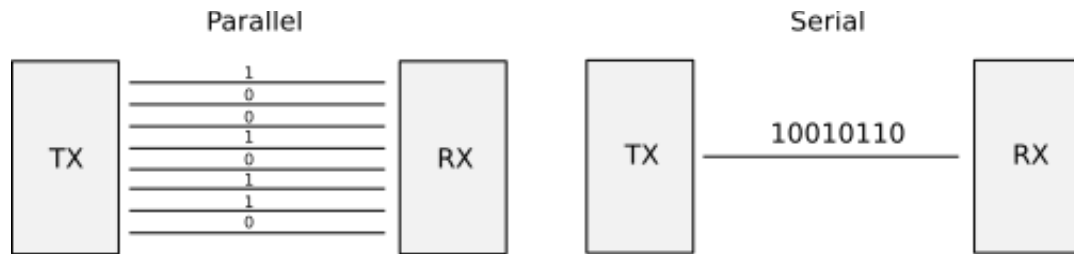

Imagine that you can sense a remote value of either "1" or "0". Imagine you are miles away from your friend and you have a pair of binoculars. You can look through them and see that he has a flag pole where the flag can either be all the way up or all the way down (he is so far away that you can't properly distinguish a flag in the middle of the pole and you aren't sure if it is all the way up or all the way down ... so you can only see the presence or absence of the flag). Can you use that to communicate?

The answer is yes ... but it takes a little work.

Let's imagine you and your friend agree on a timing rate ... lets say "10 seconds". What that means is that you will look through your binoculars every 10 seconds and write down whether the flag is high or low. You will ignore any other measurements. Your friend will also know that rate and won't change the flag any quicker or any slower than once every 10 seconds (we'll assume he can magically change the flag from low to high or high to low instantly).

You both start and you read the following flag values:

- 0 – up
- 10 – up
- 20 – down
- 30 – up
- 40 – down
- 50 – up
- 60 – up
- 70 – down

This would correspond to the value 01101011. Ta da!! You have now transmitted 8 bits of data from one place to another ... simply by agreeing the rate of change. This rate of change is called the "baud rate" and is how many bits per second can be transmitted. In our story we transmitted 1 bit every 10 seconds ... and hence had a baud rate of 0.1. In the electronics world where we can sense at extremely high speeds, typical baud rates are 9600, 4800, 19200, 38400, 57600 and 115200. As we see, we can send data

very quickly. The primary requirement is that the baud rate used between a sender and a receiver be agreed upon. Our story won't work if they they are transmitting and receiving at different rates.

The next part of our story is knowing when we are done. We could keep looking through our binoculars and writing down the flag position every 10 seconds ... but how much data is our friend sending? This is where the bit count comes into the story. Again, we agree how many bits constitute a unit of transmission. Typically this is 8 bits corresponding to a byte but the protocol allows us to agree on a transmission of 5, 6, 7, 8 or 9 bits per transmission.

If you are following the story, there is another puzzle we have to consider ... and that is when do we start recording data? If I am going to sample the data once every period, when does that period start? The answer is that every transmission of a unit of data starts with the signal high and when it goes low, that indicates that we have agreed that will be the start of the transmission period. Since we have the start indicated from a transition from high to low, then at the end of the last transmission, the signal must be left high ... and that's where a stop bit comes into play. An additional bit of data is added at the end which drives the line high.

There are three hardware supported serial interfaces on the ESP32 known as UART0, UART1 and UART2. Like all peripherals, the pins for the UARTs can be logically mapped to any of the available pins on the ESP32. However, the UARTs can also have direct access which marginally improves performance. The pin mapping table for this hardware assistance is as follows

UART	RX IO	TX IO	CTS	RTS
UART0	GPIO3	GPIO1	N/A	N/A
UART1	GPIO9	GPIO10	GPIO6	GPIO11
UART2	GPIO16	GPIO17	GPIO8	GPIO7

Having said that, the UART drivers that I recommend to use don't have this level of optimization built into them and as a result, you are pretty much free to use any pins you choose.

There is low level hardware serial support and higher level driver support. I recommend the driver level be used wherever possible.

The driver APIs are included through the inclusion of "`driver/uart.h`".

We start by populating a `uart_config_t` structure instance. This provides the core settings for a UART we want to use. An example might be:

```
uart_config_t myUartConfig;
myUartConfig.baud_rate = 115200;
myUartConfig.data_bits = UART_DATA_8_BITS;
myUartConfig.parity    = UART_PARITY_DISABLE;
myUartConfig.stop_bits = UART_STOP_BITS_1;
myUartConfig.flow_ctrl = UART_HW_FLOWCTRL_DISABLE;
myUartConfig.rx_flow_ctrl_thresh = 120;
```

Once populated, we can set the parameter of the UART with a call to

```
uart_param_config(uart_num, &uart_config)
```

While this will define all the parameters in one operation, we also have the choice to make individual calls.

Next we define the pins we wish to associate with our UART using `uart_set_pin()`. For example:

```
uart_set_pin(uartNum,
            21, // TX
            22, // RX
            UART_PIN_NO_CHANGE, UART_PIN_NO_CHANGE);
```

We can now initialize a driver using:

```
uart_driver_install(uartNum, 2048, 0, 10, NULL, 0);
```

One of the options we can specify when initializing a driver is to supply a FreeRTOS queue handle. If we supply this, then events that are detected by the UART are then posted onto the queue. We can have tasks that are blocked watching the queue ready to process incoming events when they arrive. This allows us to perform UART data processing asynchronously. If we don't want to use a queue, we specify NULL for the queue parameter.

To write data to the UART we use the `uart_write_bytes()` function.

See also:

- UART driver API
- UART low level APIs
- `uart_driver_install`
- `uart_param_config`
- `uart_set_pin`
- `uart_write_bytes`
- [Wikipedia – UART](#)
- [Serial Communication](#)

## Using the VFS component with serial

The ESP32 virtual file system (VFS) component provides an interface to UART. To use this, we initialize with a call to `esp_vfs_dev_uart_register()`. Following this we can perform file I/O operations against the VFS file system at the following paths:

- `/dev/uart/0` – UART0
- `/dev/uart/1` – UART1
- `/dev/uart/2` – UART2

Currently we can open, close, read and write to the device.

When reading a serial input, if there is no data present then we get a return from `open()` of `EWOULDBLOCK`.

See also:

- `esp_vfs_dev_uart_register`

## I2S Bus

The Inter-IC Sound (I2S) bus is a serial link protocol specifically for sound data. The protocol utilizes three lines. These are:

- `SCK` – Serial Clock line.
- `WS` – Word Select line. Indicates the channel being transmitted. 0 – channel 1 (left), 1 – channel 2 (right).
- `SD` – Serial Data line.

See also:

- I2S APIs
- I2S Peripheral
- [I2S bus specification](#)
- [Wikipedia: I2S](#)

## I2S - Camera

The I2S component is also capable of performing additional functions beyond the basic I2S. I'm not sure if this type of function is related to an I2S standards ... it may be that the Espressif designers needed a place to "host" this function and the I2S component seemed the closest.

When we think of a video camera, we should consider that it has a number of concepts that are common to most camera. First there are the concepts of horizontal and vertical sync signals. These are signals that indicate when a complete scan line has been received (or a new one is about to be received) and also an indication when a complete "image" of information has been received (or is about to be received). Then there is the data itself. If we think of an image as being composed of pixels and each pixel being represented by 16 bits of information, then we quickly see that there is a lot of information to be received. For example, if a row in an image is 320 pixels and each pixel is 16 bits then one row is 5120 bits. If an image is 240 rows then a complete image would be 1228800 bits (153,600 bytes). That's a lot of data. If we used a serial bus that could read at 400Kbps, that would be about 3 images (frames) per second. That's not great. One solution would be to use a faster serial bus ... but that may not be possible. The solution in the ESP32 is to use a wider data bus. A camera such as the OV7670 exposes an 8 bit data bus allowing us to transfer 8 bits at a time. This would give us a factor of 8 speed improvement or about 24 images per second which is usually fast enough.

The I2S support for cameras allows us to grab these 8 bits of bus data and using direct memory access, stuff them directly in RAM with minimal expense.

#### I2S - LCD

#### I2S - DMA

Direct Memory Access is the ability to receive parallel incoming data over a parallel data bus and place it directly in RAM without intervention of application CPU instructions.

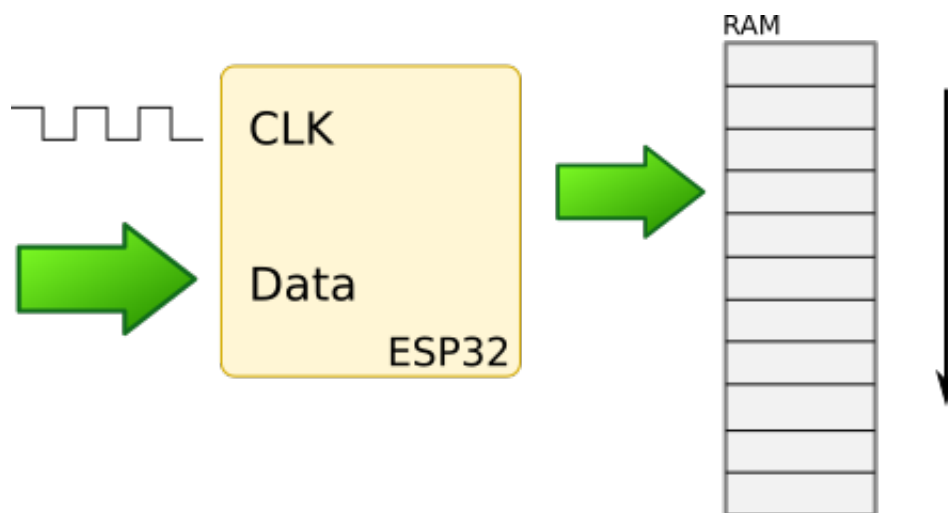

A clock signal is presented to the ESP32 along with up to 16 bits of incoming data from a bus. The pins for both the clock and the data are configurable. When the clock transitions, this is an indication that a new piece of data is available and it is automatically read by the ESP32. Upon reading the parallel data bits, the ESP32



places the read data in RAM memory at the next location it is configured to write to and then increments that pointer ready to begin again with the next byte cycle.

The I2S peripheral is the component that provides user data DMA support. There is quite a lot of setup involved in this so buckle up.

The I2S DMA support is technically provided for inbound (to ESP32) camera data but can be used for non video purposes. Video data requires a high bandwidth and a serial protocol where the data comes bit at a time would not be sufficient. Camera modules typically have an 8 bit (or more) data bus over which the data is received. The data is considered "valid" on the bus under the following conditions:

- The VSYNC signal from the camera is high.
- The HSYNC signal from the camera is high.
- The HREF signal from the camera is high.
- The PCLK signal from the camera is high.

Since we just mentioned that the I2S DMA is primarily there for camera support we have to take this into account when considering DMA by itself outside the context of cameras. Specifically, we want to set the VSYNC, HSYNC and HREF signals to be permanently high and use the PCLK signal as the clocking in of new data on the bus.

In the ESP32, pins are multiplexed meaning that almost any pin can serve almost any purpose. This means we can map physical pins to their logical mappings. For our discussion on DMA, we have the following logical pins:

I2S0I_DATA_IN0_IDX to I2S0I_DATA_IN15_IDX	16 bits of input data (SD)
I2S0I_V_SYNC_IDX	VSYNC logical pin
I2S0I_H_SYNC_IDX	HSYNC logical pin
I2S0I_H_ENABLE_IDX	HREF logical pin
I2S0I_WS_IN_IDX	PCLK logical pin

We can use the ESP-IDF function called `gpio_matrix_in()` to map from physical pins to their logical counterparts. There are two "special" but "logical" pins known as `0x30` and `0x38`. Specifying a pin of `0x30` means a constant low value while a pin of `0x38` means a constant high value.

By experimentation:

When we ask to read samples and we have enough buffer space to hold all the samples in one buffer, we get an interrupt with:

IN\_DONE=1, IN\_DSCR\_EMPTY=0, IN\_DSCR\_ERR=0, IN\_ERR\_EOF=0,  
IN\_SUC\_EOF=1

and the descriptor holds

size=4092, length=2000, offset=0, sosf=1, eof=1

When we ask to read more samples than will fit in one buffer, we get an interrupt with

IN\_DONE=1, IN\_DSCR\_EMPTY=0, IN\_DSCR\_ERR=0, IN\_ERR\_EOF=0,  
IN\_SUC\_EOF=0

and the descriptor holds

size=4092, length=4092, offset=0, sosf=1, eof=0

Now we get to introduce the concept of a DMA buffer. The notion here is that DMA wants to fill a memory buffer with data asynchronously retrieved from a parallel data bus. However, if all we are doing is stuffing the received data into RAM without processing it, that is going to be of limited use. Ideally we want to not only receive data but process it as it arrives. If we think about the alternative which would be to receive all the data we need and then process it, we might find that we run out of RAM space. For example, if we are processing an incoming video stream and are wanting to stream it out over the network, we will usually want to stream what we have received during the last short interval while at the same time accumulating the next interval. To that end we have a series of DMA buffers that are chained together in a list. Pictorially, what we then have is the following:

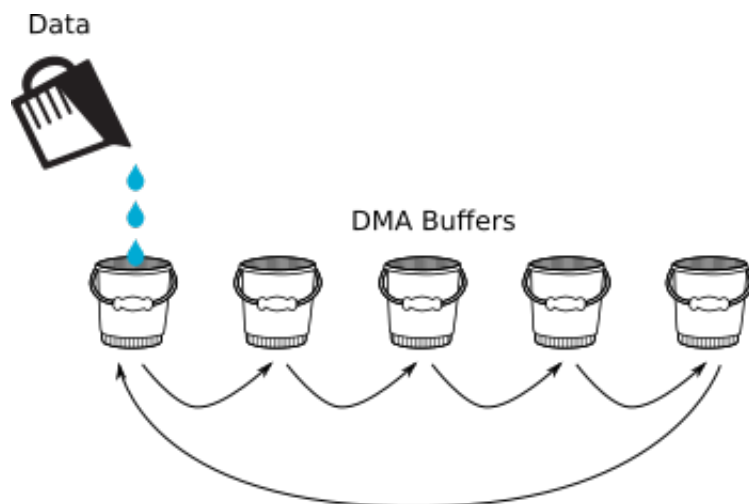

Data is arriving at a steady rate and a DMA buffer starts to fill. When the buffer fills, two things happen. First we receive an interrupt telling us that a DMA buffer is now full and ready for consumption. In addition (and instantaneously) newly arriving data starts to fill the next buffer with no lost or missed data (in the analogy, we didn't spill any). We can

now start to consume the previously filled buffer without having to worry about what is happening with the other buffers. When the next buffer fills, a new interrupt will be generated.

It takes some thought to see the benefits of this story but now we can start to reason about capacity and throughput. Let us imagine the simplest story which consists of two buffers that we call BufferA and BufferB. Initially, BufferA starts to fill with data. When BufferA fills, DMA switches to start filling BufferB and informs us via interrupt that BufferA is full. We can now process the data in BufferA while concurrently, BufferB is being filled with new data. When BufferB is full, DMA will have cycled around and will now start filling BufferA again. For this story to work, we must be able to process a buffer's worth of data in less time than it takes a buffer to be filled by DMA. Specifically, if we are told that we can start processing BufferA, we had better have consumed all the data we need from it quicker than DMA can fill BufferB because when BufferB has filled, DMA will expect BufferA to be empty again.

If we can't process a buffer's worth of data faster than a buffer is filled, we probably want to re-think our design or implementation ... at a minimum, we will then find that we need to maintain as many buffers as necessary to hold all the data we are expecting to receive. Another strength of buffers is the notion that we may be able to get away with processing buffer data if the *average* time to process a buffer is less than it takes to fill a buffer. Here we will likely want to have more than two buffers. On average each time we fill a buffer, by the time the next one is also filled, we will have consumed the original data. However, if our processing of data is *laggy* or has other non-constant time processing characteristics, then as long as we have sufficient buffers, we don't have to have consumed a buffers worth of data by the time the next one fills as long as on average we have a sufficient processing rate.

Enough with the theory. Let us now consider the DMA implementation as found in the ESP32. First we start with the data type called "l1desc\_t". This cryptically named type is a "linked list descriptor". Loosely, you can think of this as the buffer. The structure contains a set of fields that (among others) are:

- `buf` – A pointer to a chunk of RAM storage that will contain DMA received data.
- `size` – The size (in bytes) of the storage pointed to by `buf`.
- `length` – The number of bytes actually written by DMA into the buffer.
- `owner` – Who owns this buffer? The options are either the CPU (0) or the DMA controller (1). The DMA controller will only use this linked list descriptor if the flag says that it is owned by DMA.

- `End of list` – Is this descriptor the end of the list? It is the end of the list if the value is 1 and is not the end of the list if the value is 0.
- `next` – The pointer to the next instance of an "l1desc\_t" structure. This will be the next buffer to be filled after this one has been filled. If this points to a previous "l1desc\_t" then we will have formed a circular chain. (Note: The field is not actually called `next` but I wanted to keep this clean for our discussion ... there are more implementation details that are not pertinent to the story).

Hopefully, you are following the story so far ... unfortunately though, things about to get much more complex.

First, let us think about the implementation of `l1desc_t`. For reasons unknown to me, the implementation has sized both `size` and `length` fields to be a maximum of 12 bits in length. This means that the size of a buffer can be between 0 and 4095 bytes ( $2^{12}-1 = 4095 = 0b1111\ 1111\ 1111$ ). Take this into account and ensure you configure your `l1desc_t` instances correctly.

The DMA implementation does **not** write a byte at a time into the buffer. It wants to be much more efficient than that and writing individual bytes as they are received wouldn't give us the maximum rate we desire. The ESP32, being a 32 bit device, is able to move 32bits of data at a time. As such, the ESP32 writes a full 32 bits each time DMA writes into the buffer. If we think about this a moment, we will find that the length of data used in the buffer will thus be a multiple of 4 (32 bits = 4 bytes). This then further says that the maximum buffer size can only be 4092 bytes. Why? Well 4092 is evenly divisible by 4 and the next multiple up would be 4096 which is more than 12 bits in length and hence is too large to hold in a 12 bit number.

Next let us think about the unit of DMA read data. DMA can read up to 16 parallel bits of information at a time. But since DMA writes 32 bits of data to the buffer as a unit, it must thus read two 16 bit values from the bus for each buffer write.

For many applications of the ESP32 we may not need to read a data bus that is 16 bits wide. We may only need to work with a bus that is 8 bits wide. Unfortunately, the ESP32 DMA has no accommodation for this notion. We can tell the ESP32 to not bother with the upper 8 pins of the 16 input pins and simply assume them to be 0, however the ESP32 wishes to process 16 bit values only.

From an architectural perspective, data received from the data bus is first stored in a TX FIFO storage area that is 32bits wide with 64 elements deep. The data written externally through the IO pins first passes through this TX FIFO. Similarly, a second identically sized area called the RX FIFO also exists. Data accumulates there before passing out into the data bus and on to memory.

To work in camera mode we need:

Register	Flag	Value
I2S_CONF2_REG	I2S_LCD_EN	1
I2S_CONF2_REG	I2S_CAMERA_EN	1
I2S_CONF_REG	I2S_RX_SLAVE_MOD	1
I2S_CONF_REG	I2S_RX_MSB_RIGHT	0
I2S_CONF_REG	I2S_RX_RIGHT_FIRST	0
I2S_CONF_CHAN_REG	I2S_RX_CHAN_MOD	1
I2S_FIFO_CONF_REG	I2S_RX_FIFO_MOD	1

See also:

- [ESP32 API Reference – I2S](#)
- [esp-idf – test – test\\_unal\\_dma.c](#)
- ESP32 Technical Reference – Chapter 6 – DMA Controller

### Interrupts

There are a wide range of interrupts associated with DMA. We can capture these by writing an interrupt handler:

```
static void IRAM_ATTR dmaInt(void* arg) {
    // do something
}
```

We can then associate this ISR with the I2S0 peripheral:

```
errRc = esp_intr_alloc(
    ETS_I2S0_INTR_SOURCE,
    ESP_INTR_FLAG_INTRDISABLED | ESP_INTR_FLAG_LEVEL1 | ESP_INTR_FLAG_IRAM,
    &dmaInt,
    NULL,
    &intHandle);
```

The handler can then be enabled with:

```
esp_intr_enable(intHandle);
```

Finally, we can enable which interrupts are masked on/off:

```
I2S0.int_ena.in_suc_eof = true;
...
```

When an interrupt is triggered, we can determine its cause by examining the flags found at `I2S0.int_raw`. We can also use the masked interrupt flag which shows only the interrupts that have occurred and that are also enabled interrupts.

## RMT - The Remote Peripheral

The primary purpose of this component of the ESP32 is to generate pulses sent via an infrared LED. When you point your TV remote control at your TV and press a button, an infrared LED at the front of your controller sends a sequence of pulses that are received by the TV and decoded. Since an infrared LED can be either "on" or "off" at any given time, the signal is encoded in the duration that the LED is either on or off.

A data item in the RMT represents one bit of information and is composed of a 16 bit value.

level [15]	period [14:0]
------------	---------------

The level bit is either 1 or 0 describing the output signal while the period (15 bits in length) is the duration in clock ticks for which that level will be sent. 15 bits give us a range from 1-32767. A value of 0 for the period is used as an end marker. The normal maximum number of bit records is 128 (or 256 bytes of record data).

The RMT has 8 distinct channels with each channel having 128 16 bit records. Should we wish to send more than 128 records, we can extend a channel to use the channel data of subsequent adjacent channels. For example, if we are using only channel 0 then the data available for it can be that of channel 0, channel 1 up to channel 7 giving us a total of 1024 value records (1024 data items which means 1024 bits of data or 2048 bytes of data items).

There is also an interesting mechanism that involves the buffer for a channel wrapping around. Imagine that we have a default buffer size of 128 \* 16bit records. If we need to send more than 128 records, we can pre-load a buffer with our first 128 values and set the RMT transmitting. When it has transmitted the first 128 values, it will generate an interrupt that can be used to re-fill the buffer with the new values and progress will continue.

The hardware allocates 512 instances of 32 Bit records ( $512 * 32/8 = 2048$  bytes) which can be read and written by the RMT hardware in the CPU. Each 32 Bit record contains two data items. Each channel has one block of 64 instances of 32 bit records associated with it which gives us 128 data items of wave form (1 transition is encoded in 16 bits).

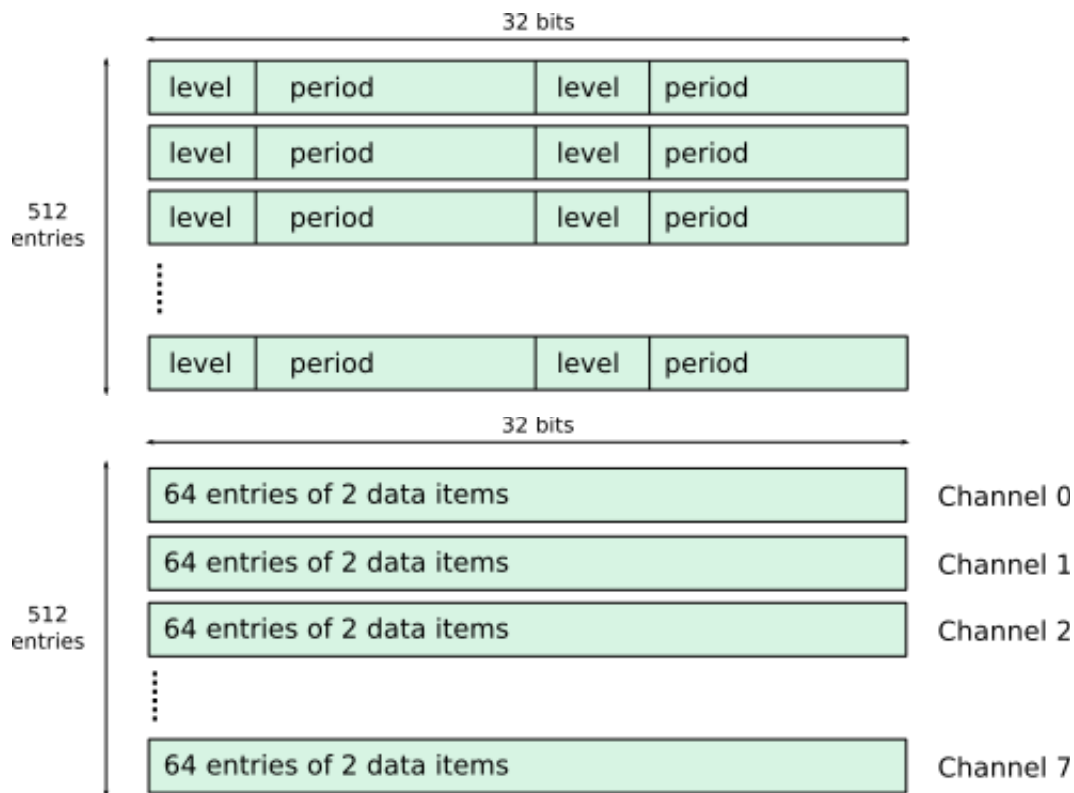

Should we need a transmission that is greater than 128 data items, we can consume the adjacent block which will give us a further 128 data items transitions. We can only do this by using channel block for the next higher adjacent channel. We can actually specify that we want to use ALL the channels for a single transmission giving us a maximum transmit bit transition of  $8 \times 128 = 1024$ . Note that there is no wrap around. So channel 0 can use the blocks of channel 0 through channel 7, channel 1 can use the blocks of channel 1 through channel 7 ... and channel 7 can only use its own memory block.

To use the driver, one typically follows this recipe:

- Complete an `rmt_config_t` structure.
- Call `rmt_config()` passing in the `rmt_config_t` structure.
- Call `rmt_driver_install()` to install the driver.
- Build an array of records to send.
- Call `rmt_write_items()` to send the stream.

Since RMT is all about setting signals for interval durations, there is a lot to be discussed about time. First we must discuss the base clock. By default this runs at 80MHz. That means it ticks 80,000,000 times a second or 80,000 times a millisecond or 80 times a microsecond or 0.08 times a nano second. Flipping this around, our granularity of interval is  $1/80,000,000$  is 0.000000125 seconds or 0.0000125 milliseconds or 0.0125 microseconds or 12.5 nanoseconds. I hope we agree, that's pretty fast.

Since these are pretty small durations, we can "logically" slow our clock down for timing purposes. The base clock speed is 80MHz but we can provide a divider which is an integer value against which the base clock speed is divided to provide a new tick rate that is used as the interval value for timings. The integer value is 8 bits so we can divide between 1 and 255. At 255 we have are down to about 314KHz. Since the base speed is 80, it seems to make sense to divide by 8, 80 or 160, giving rates of 10MHz, 1MHz and 500KHz.

The period range of a cycle is 15 bits giving us a value between 1 and  $2^{15}$  (32768). For example, if we divide the base clock by 80 then the granularity unit becomes 1 microsecond so if we delay for 1000 units, we end up at 1msec.

When there is no current transmission, we can set the idle level to be enabled and either high or low. This sets the output pin to this idle value when not in use.

Here is a sample RMT application:

```
#include <freertos/FreeRTOS.h>
#include <freertos/task.h>
#include <esp_log.h>
#include <driver/rmt.h>
#include "sdkconfig.h"

static char tag[] = "rmt_tests";
static void dumpStatus(rmt_channel_t channel) {
    bool loop_en;
    uint8_t div_cnt;
    uint8_t memNum;
    bool lowPowerMode;
    rmt_mem_owner_t owner;
    uint16_t idleThreshold;
    uint32_t status;
    rmt_source_clk_t srcClk;

    rmt_get_tx_loop_mode(channel, &loop_en);
    rmt_get_clk_div(channel, &div_cnt);
    rmt_get_mem_block_num(channel, &memNum);
    rmt_get_mem_pd(channel, &lowPowerMode);
    rmt_get_memory_owner(channel, &owner);
    rmt_get_rx_idle_thresh(channel, &idleThreshold);
    rmt_get_status(channel, &status);
    rmt_get_source_clk(channel, &srcClk);
}
```



```

ESP_LOGD(tag, "Status for RMT channel %d", channel);
ESP_LOGD(tag, "- Loop enabled: %d", loop_en);
ESP_LOGD(tag, "- Clock divisor: %d", div_cnt);
ESP_LOGD(tag, "- Number of memory blocks: %d", memNum);
ESP_LOGD(tag, "- Low power mode: %d", lowPowerMode);
ESP_LOGD(tag, "- Memory owner: %s", owner==RMT_MEM_OWNER_TX?"TX":"RX");
ESP_LOGD(tag, "- Idle threshold: %d", idleThreshold);
ESP_LOGD(tag, "- Status: %d", status);
ESP_LOGD(tag, "- Source clock: %s", srcClk==RMT_BASECLK_APB?"APB (80MHz)":"1MHz");
}

void runRmtTest() {
    ESP_LOGD(tag, ">> runRmtTest");

    rmt_config_t config;
    config.rmt_mode = RMT_MODE_TX;
    config.channel = RMT_CHANNEL_0;
    config.gpio_num = 21;
    config.mem_block_num = 1;
    config.tx_config.loop_en = 0;
    config.tx_config.carrier_en = 0;
    config.tx_config.idle_output_en = 1;
    config.tx_config.idle_level = 0;
    config.tx_config.carrier_duty_percent = 50;
    config.tx_config.carrier_freq_hz = 10000;
    config.tx_config.carrier_level = 1;
    config.clk_div = 80;

    ESP_ERROR_CHECK(rmt_config(&config));
    ESP_ERROR_CHECK(rmt_driver_install(config.channel, 0, 0));
    dumpStatus(config.channel);

    rmt_item32_t items[3];
    items[0].duration0 = 10000;
    items[0].level0 = 1;
    items[0].duration1 = 10000;
    items[0].level1 = 0;

    items[1].duration0 = 10000;
    items[1].level0 = 1;
    items[1].duration1 = 5000;
    items[1].level1 = 0;

    items[2].duration0 = 0;
    items[2].level0 = 1;
    items[2].duration1 = 0;
    items[2].level1 = 0;

    while(1) {
        ESP_ERROR_CHECK(rmt_write_items(config.channel, items,
            3, /* Number of items */
            1 /* wait till done */));
    }
}

```

```

    vTaskDelay(1000/portTICK_PERIOD_MS);
}
ESP_LOGD(tag, "<< runRmtTest");
}

```

So far we have discussed emitting a waveform of signals but there is a powerful second capability of the RMT and this to be able to capture received waveforms that might be arriving.

To use the RMT in receiver mode, we call `rmt_config()` specifying that the `rmt_mode` of the given channel should be `RMT_MODE_RX`. Note that a channel can be only one of a receiver or transmitter at any given time. Once a channel is configured to be a receiver, it will start watching the input and be considered to be in its idle state. When it starts to see transitions, it will begin recording their values and durations into RAM. It will continue to do this until it no longer sees transitions for a period of time known as the idle threshold at which time it will return to its idle state and write a termination record into the output data. A termination record is simply a data item that has a duration of 0. As an indicator that a signal train has been received, when it returns to idle state, an `RX_END` interrupt is generated. There is also the ability to perform simple noise filtering. Records of a duration less than a configurable threshold can be automatically removed.

To obtain the received data, we need to become familiar with the ring buffer functions. These are supplied as part of the RTOS set of functions. Through the RMT APIs, we can call `rmt_get_ringbuf_handler()` which returns an instance of `RingbufHandle_t` which is a reference to a ring buffer whose buffer size is defined when we made the call to `rmt_driver_install()`. Through this `RingbufHandle_t` we can then call `xRingbufferReceive()` to get (with optional blocking) an array of `rmt_item32_t` records that contains the received data. Once we are done with this, we call `vRingbufferReturnItem()` to release the storage.

When working with RMT, measurement of times is crucial, after all that's the core of the story. When we consider the data structure representing a value is 16 bits long with 1 bit used for the signal value, that leaves us 15 bits per measurement to encode the value. The maximum value a 15 bit integer can have is 32767 ( $2^{15} - 1$ ). Let us put this in perspective when looking at the following signal trace:

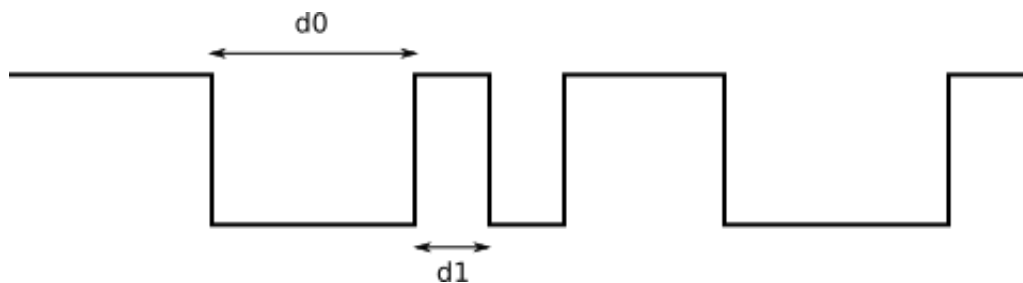

If we focus on just the start, we see that the signal was low for a duration of  $d_0$  and then high for a duration of  $d_1$ . We measure duration in seconds and, of course we can perform simple arithmetic to scale into milliseconds or microseconds with just multiplication factors.

Now let us think of the duration returned by RMT as a 15 bit value. That duration is **not** a direct measurement of time. It is actually a count of clock ticks. If you think of a wall clock with a second hand, each tick represents one second ... and hence one tick indicates one second has passed. The clock rate of our ESP32 is 80MHz (80 million ticks per second). That means that 1 tick is  $1/80,000,000$  of a second or 12.5 nano seconds. Note that is **nano** seconds and not milli or micro seconds. So if 1 tick is 12.5 nano seconds, at 80MHz, the maximum duration that we can measure would be 15 bits worth of data or  $65535 * 12.5 \text{ ns} = 819\text{us}$ . And in there is the problem. 819us is still less than a millisecond and that is not much time at all. Many of the measurements we care about might be far more than this ... measurements in the 10s of milliseconds are not uncommon. If the maximum measurement we can take is 819us what is our solution?

One way would be to increase the number of bits available in the recorded data but there is a better solution. We can "logically" use a slower clock. Imagine if the clock didn't tick at 80MHz but instead ticked at 800KHz ... a factor of 100 slower. This would mean that 1 tick would be  $1/800,000$  of a second or 1.25 micro seconds. A measurement of 65535 tick would now have a duration of 81.9 milliseconds ... and that is more usable. The downside of this is that we have reduced the granularity of a tick. If we are measuring changes in signal which change faster than once every 1.25 microseconds, then we will miss some of the changes. However, for the vast majority of purposes, we won't need that level of granularity. When we configure the RMT peripheral, we can supply a "clock divider" which is an 8 bit value that allows us to specify the divisor for our clock.

Imagine our clock divisor is  $CLK\_DIV$ . The number of ticks in 10 micro seconds then becomes:

$$TICK_{10\_US} = 80,000,000 / CLK\_DIV / 100,000$$

If we then are told by RMT that  $COUNT$  ticks have occurred, that would be:

$$COUNT * 10 / TICK_{10\_US} \text{ microseconds}$$

See also:

- Remote Control Peripheral – RMT
- `rmt_config`
- `rmt_driver_install`
- `rmt_write_items`

- `rmt_wait_tx_done`
- `xRingbufferReceive`
- Ring buffer within FreeRTOS
- Chapter 7 of ESP32 Technical Reference Manual – Remote Control Peripheral

## Timers and time

The ESP32 leverages the FreeRTOS environment which provides the concept of a clock tick. This isn't a real-clock (as in a CPU clock) but is instead a logical timer period defined by the FreeRTOS. Currently, the default tick is one millisecond but this can be changed in the make menuconfig options (but I wouldn't recommend it). There is a constant called `portTICK_PERIOD_MS` that defines the duration (in milliseconds) of a FreeRTOS clock tick.

Within our code, we may wish to delay for a period of time. We can use the `vTaskDelay()` function. This function takes as input the number of FreeRTOS ticks to sleep. We can convert from time to ticks using:

```
timeValInMillisecs/portTICK_PERIOD_MS
```

for example:

```
vTaskDelay(timeValInMillisecs/portTICK_PERIOD_MS)
```

Another aspect of working with time is time calculations and measurement. The function `system_get_time()` returns a 32 bit unsigned integer (`uint32_t`) value which is the microseconds since the device booted. This value will roll over after 71 minutes.

**Note:** `system_get_time()` is deprecated, use `gettimeofday()` instead.

When we use `gettimeofday()` we get back a `struct timeval` which contains two fields:

- `tv_sec` – The time in seconds
- `tv_usec` – The time in micro seconds

The reason that a structure is returned is that it might not be possible to accommodate this value in a single number, especially on a 32bit system such as the ESP32. We may need to perform arithmetic on these values ... for example to measure the duration of some activity, we might get the time before and the time after and subtract one from another. A library of simple routines is provided here:

<https://github.com/nkolban/esp32-snippets/tree/master/c-utils>

called "`c_timeutils.c`" and "`c_timeutils.h`". The functions supplied include:

- `struct timeval timeval_add(struct timeval *a, struct timeval *b)` – Add two `struct timeval` structures together resulting in the sum.
- `void timeval_addMsecs(struct timeval *a, uint32_t msecs)` – Add a specified number of milliseconds to the `timeval`.
- `uint32_t timeval_durationBeforeNow(struct timeval *a)` – Return the number of milliseconds since the past time.
- `uint32_t timeval_durationFromNow(struct timeval *a)` – Return the number of milliseconds until the future time.
- `struct timeval timeval_sub(struct timeval *a, struct timeval *b)` – Subtract one `timeval` from another.
- `uint32_t timeval_toMsecs(struct timeval *a)` – return the number of milliseconds represented by the `timeval`.

Another useful function is one supplied by FreeRTOS called `xTaskGetTickCount()`. This returns the number of clock ticks that have elapsed since FreeRTOS was started. We can use this to measure elapsed time between distinct points.

What if we need a granularity of time smaller than a microsecond? Hopefully you won't need this often ... however some solutions such as working with the WS2812 LEDs do in fact require ultra fine precision.

One possible solution is to drop down to assembly language programming. There is a special register managed by the ESP32 which is called "`ccount`" which measures cycles of operation. The value of this is incremented each time an operational cycle completes.

The value of this register can be retrieved with the following C code:

```
static inline uint32_t getCycleCount() {
    uint32_t ccount;
    __asm__ __volatile__ ("rsr %0,ccount":"=a" (ccount));
    return ccount;
}
```

This fragment uses the in-line assembler to transform an assembly language statement into its corresponding operational instruction.

A specialized function called `xthal_get_ccount()` provides a similar function.

Note: The following is **disabled** in EPS32 at this time.

Another mechanism to suspend execution is a call to `nanosleep()`. This takes as input a `struct timespec` that includes seconds and nanoseconds. Remember 1 second = 1000 milliseconds = 1000000 microseconds = 1000000000 nanoseconds.

If we need additional timer functions, the ESP32 provides four high resolution timers that are divided into two groups of two.

For the most part, when we want our applications to perform tasks at certain times or block for configurable amounts of time, the use of the FreeRTOS timers will be the best solution.

After having looked at internal timing, let us now look at real-world or "wall clock" timing. The ESP-IDF provides a rich assortment of POSIX based APIs for working with wall clock times. There are two primary representations of a wall clock time those are "`time_t`" which is basically a large integer. The value is the number of seconds that have elapsed since the point of time known as the "epoch" which is midnight on the 1<sup>st</sup> of January 1970 in GMT (near London England). Given a `time_t` value, we can calculate the date and time. Thankfully, we don't have to worry about that complex arithmetic as library functions are supplied for us.

The second data type we will consider is a structure called "`struct tm`". This structure contains fields for all the useful date and time values such as the hour, minute and second as well as year, month and day (and a few more). When we start to think about wall clock time, a new consideration comes into play. If I look at my clock and it says 3:51pm I know what time it is. However, that is my "local" time sitting in Texas. If I called a friend in London, he would say its 9:51pm. The reason for this is that the world is divided into distinct time zones and the declaration of any given time is relative to the time zone. If I tell my wife that the movie starts at 12:30pm, there is usually no ambiguity as we are "local" to each other. However, if a friend in London sends me a directory in a ZIP file and I look inside that directory, what time should I see the files as having been modified? If he modified a file and immediately sent it to me, he would say "I changed the file at 9:51pm" ... is that what I should "see" when I look at the file? The answer is no, I should see that he modified the file at "3:51pm" which would be my equivalent local time.

Within an ESP32 environment, we can set an environment variable using the `setenv()` API. The variable is called `TZ` and is used to define the local time zone in which the ESP32 is operating. From a time zone string, the ESP32 can then perform the additions or subtractions to determine the local time. Note that this is only possible if we record the time stamp of some data relative to an agreed convention ... and this is where Universal Coordinated Time (UTC) comes into the picture. UTC is the GMT time zone and is the value we get back from a call to `time()`.

Let us break down the available functions supplied by ESP-IDF for time manipulation:

- Get the current time as a `time_t` – `time()`
- Convert a `time_t` to a `struct tm` ignoring timezone – `gmtime()`
- Convert a `time_t` to a `struct tm` using the timezone – `localtime()`
- Convert a `struct tm` to a `time_t` – `mktime()`
- Convert a `struct tm` into a string – `asctime()`
- Convert a `time_t` into a string – `ctime()`. Basically a convenience function for `asctime(gmtime())`.

A common date representation is the [ISO 8601](#). This is commonly found in JSON and JavaScript applications. We can build this quite easily using the following:

```
time_t timeNow;
time(&timeNow);
struct tm *ptm = gmtime(&timeNow);
strftime(timeString, sizeof(timeString), "%FT%TZ", ptm);
```

See also:

- Working with SNTP
- `system_get_time`
- Hardware Timers
- `gettimeofday`
- Timers in FreeRTOS
- `asctime`
- `ctime`
- `gmtime`
- `localtime`
- `mktime`
- `settimeofday`
- `time`
- `times`
- `tzset`
- `vTaskDelay`

## LEDC - Pulse Width Modulation - PWM

The idea behind pulse width modulation is that we can think of regular pulses of output signals as encoding information in the duration of how long the signal is kept high. Let us imagine that we have a period of 1Hz (one thing per second). Now let us assume that we raise the output voltage to a level of 1 for  $\frac{1}{2}$  of a second at the start of the period. This would give us a square wave which starts high, lasts for 500 milliseconds and then drops low for the next 500 milliseconds.

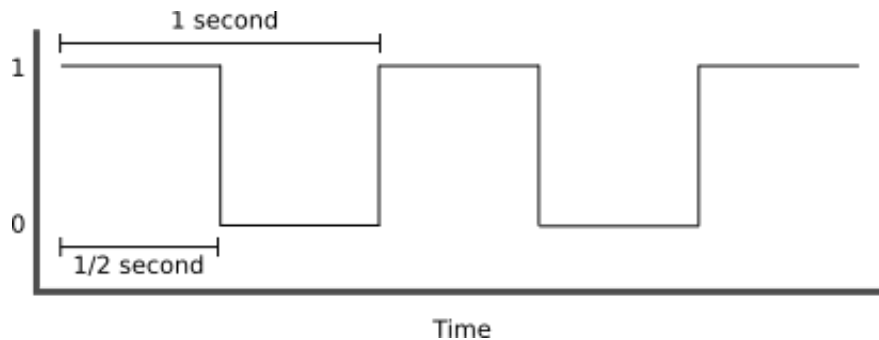

This repeats on into the future. The duration that the pulse is high relative to the period as a whole allows us to encode an analog value onto digital signals. If the pulse is 100% high for the period then the encoded value would be 1.0. If the pulse is 100% low for the period, then the encoded value would be 0.0. If the pulse is on for "n" milliseconds (where n is less than 1000), then the encoded value would be  $n/1000$ .

Typically, the length of a period is not a second but much, much smaller allowing us to output many differing values very quickly. The ratio of the "on" signal to the period is called the "duty cycle". This encoding technique is called "Pulse Width Modulation" or "PWM".

There are a variety of purposes for PWM. Some are output data encoders. One commonly seen purpose is to control the brightness of an LED. If we apply maximum voltage to an LED, it is maximally bright. If we apply  $\frac{1}{2}$  the voltage, it is about  $\frac{1}{2}$  the brightness. By applying a fast period PWM signal to the input of an LED, the duty cycle becomes the brightness of the LED. The way this works is that either full voltage or no voltage is applied to the LED but because the period is so short, the "average" voltage over time follows the duty cycle and even though the LED is flickering on or off, it is so fast that our eyes can't detect it and all we see is the apparent brightness change. Internet articles suggest a frequency of between 300 and 1000 Hz are good values for LED dimming.

Now let us look at how the ESP32 provides PWM support. Within the ESP32 there is hardware support for PWM supplied in a component called the "LEDC/PWM". It supplies 8 channels of output each of which can be controlled independently from the others. The ESP32 PWM functions are powerful but at first they can sound complex. The reality is that they actually aren't that hard and the power and flexibility within them is worth the learning. One just has to slow down and contemplate them for a bit.

First, understand that there are four distinct timers. Think of an individual timer as "ticking along" counting up until it reaches a maximum number and then resets itself to zero and the story repeats. The time between resets (i.e. how long it takes to count to the maximum value) is the frequency value measured in Hz (things per second). For example, if we specified a frequency of 1Hz, it would take 1 second to count from 0 to the maximum value and then repeat. If we specified a frequency of 1000Hz (1000



things per second), it would only take 1 millisecond to count from 0 to the maximum value.

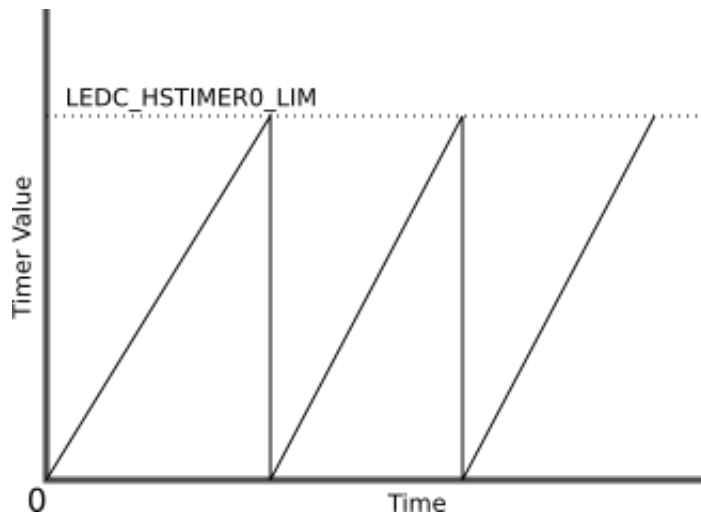

So what is this "maximum" value that I have been talking about? Each timer counts upwards and we can define how many "bits" in a number before it resets. Our choices when configuring a timer are 10, 11, 12, 13, 14 or 15 bits. These correspond to maximum values of 1023, 2047, 4095, 8191, 16383 and 32767. Pause here and think about the relationship between frequency and bit size of the counter. If we set our timer to have a frequency of 1Hz and set our bit size to be 12 bits, then it will take 1 second for our timer to count from 0 to 4095. If our bit size were 15 bits, it would take 1 second for our timer to count from 0 to 32767. It is important to realize that the frequency is how long it takes to count from 0 to the maximum number. If we have higher bit sized maximums, then we just have more "timer increments" ... but in the same frequency specified period of time. What we thus have is more "granularity" in the timings.

Now that we have looked at the timer, lets turn our attention to the notion of a channel. A channel be thought of as the PWM output signal. When we define a channel, we specify which of the GPIO pins the signal will appear upon. We also specify which of the four timers we plan on associating with the channel. Since a timer defines a frequency, this defines the frequency (or period) of our PWM signal. Finally, and arguably most importantly, we define the duty cycle of the PWM output. This is the time duration within a period that the PWM output signal will be high before it goes low. The value is supplied as a number of timer ticks and **not** a period of time and this is where folks can get lost.

Think about the timer. It starts at 0 and counts upwards to its maximum value (as defined by its bit size) and then resets. The rate of counting upwards is specified by the frequency defined on the timer. If the frequency is 1Hz, then the timer takes 1 second

to count from 0 to the maximum. The duty cycle value specifies the timer value after which the PWM output signal will flip from high to low.

For example, imagine we wanted a PWM signal with a period of 1 second that is high for  $\frac{1}{4}$  of a second with a 10 bit granularity. We would set the frequency of the timer to be 1 Hz and the granularity of the timer to be 10 bits. This then says it takes 1 second for the timer to count from 0 to 1024. If we want the duty cycle of the PWM to be  $\frac{1}{4}$  of a second, then we want to switch the output signal  $\frac{1}{4}$  of the way through the timer count which would be  $1024 * \frac{1}{4} = 256$ .

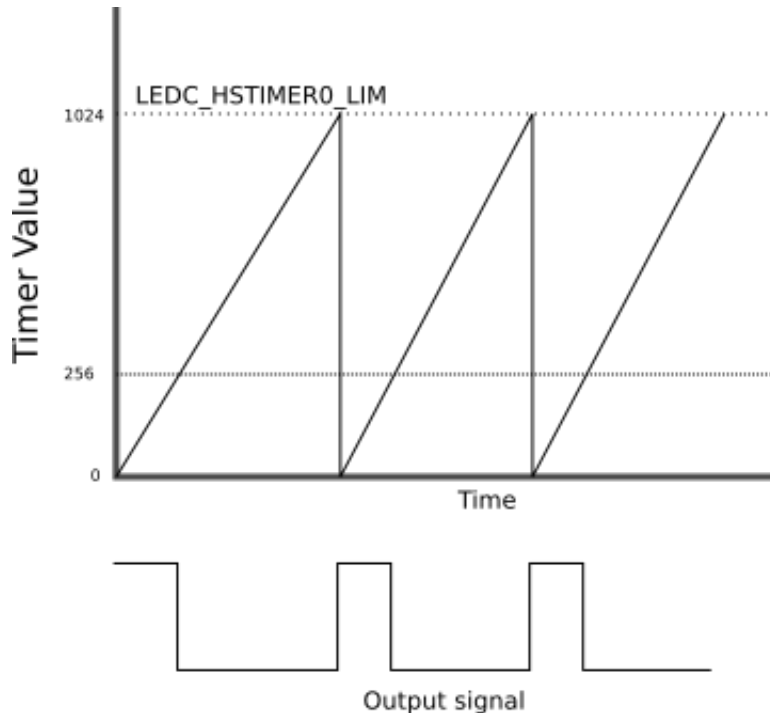

To use the LEDC/PWM functions we would follow this recipe:

1. Set a LEDC timer. We do this by calling `ledc_timer_config()` passing in a `ledc_timer_config_t` structure pointer.

```
ledc_timer_config_t timer_conf;
timer_conf.duty_resolution = LEDC_TIMER_12_BIT;
timer_conf.freq_hz        = 1000;
timer_conf.speed_mode     = LEDC_HIGH_SPEED_MODE;
timer_conf.timer_num      = LEDC_TIMER_0;
ledc_timer_config(&timer_conf);
```

2. Set a LEDC channel.

```
ledc_channel_config_t ledc_conf;
ledc_conf.channel      = LEDC_CHANNEL_0;
```

```
ledc_conf.duty          = 1024;
ledc_conf.gpio_num      = 16;
ledc_conf.intr_type     = LEDC_INTR_DISABLE;
ledc_conf.speed_mode    = LEDC_HIGH_SPEED_MODE;
ledc_conf.timer_sel     = LEDC_TIMER_0;
ledc_channel_config(&ledc_conf);
```

At a low level, the frequency is given by

$$f = \frac{\text{Clock Speed}}{\text{Divisor} \times \text{precision}}$$

So Divisor is

$$\text{Divisor} = \frac{\text{Clock Speed}}{f \times \text{precision}}$$

See also:

- [Wikipedia: Pulse-width modulation](#)
- `ledc_channel_config`
- `ledc_timer_config`
- Servos

### Automated PWM fading

The hardware support for PWM in the ESP32 also includes an intriguing feature that relates to "fading". If we consider the duty cycle of PWM, we can think of it as the percentage of frequency that the signal is high vs low. So a 100% duty cycle will be constantly high and a 0% duty cycle constantly low with values in between giving us an "average" output over time. This can be used to "dim" LEDs. Now imagine that we wanted to change the brightness of the LED over time. Effectively we would be "fading" the brightness. For example, if we wanted to have the LED go from 100% brightness to 50% brightness over 2 seconds, the brightness output might look as follows:

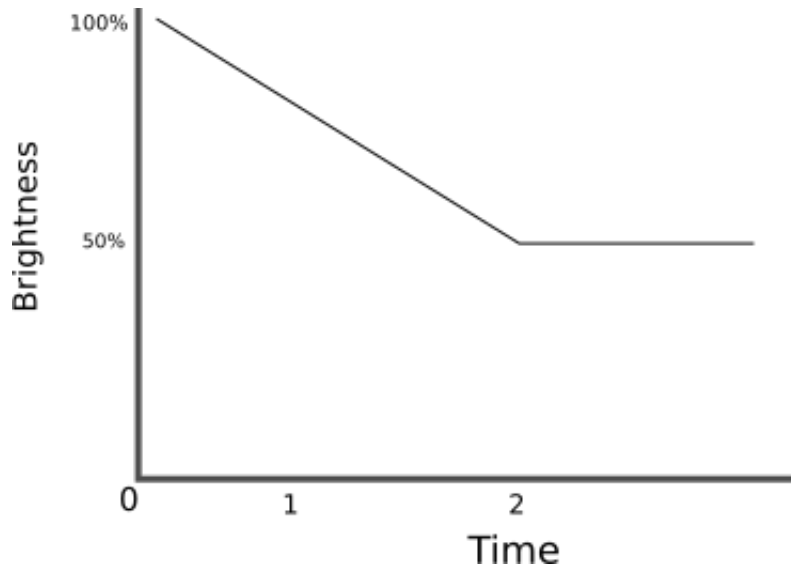

Since the value of the duty cycle corresponds to the brightness of the LED, then what we are talking about here is reducing the duty cycle value over time. Within the hardware of the ESP32 PWM, we can specify an initial duty cycle value and the amount that the duty cycle should be reduced by each configurable timer interval.

### Analog to digital conversion

Analog to digital conversion is the ability to read a voltage level found on a pin between 0 and some maximum value and convert that analog value into a digital representation. Varying the voltage applied to the pin will change the value retrieved when read. The ESP32 has an analog to digital converter built into it with a resolution of up to 12 bits which is 4096 distinct values. What that means is that 0 volts will produce a digital value of 0 while the maximum voltage will produce a digital value of 4095 and voltage ranges between these will produce a correspondingly scaled digital value.

One of the properties on the analog to digital converter channels is attenuation. This is a voltage scaling factor. By default, the allowable input range is 0-1V but with different attenuations we can scale the input voltage into this range. The available scales beyond the 0-1V include 0-1.34V, 0-2V and 0-3.6V.

Here is an example application using the APIs. What this example does is print the value read from the ADC every second.

```
#include <driver/adc.h>
#include <esp_log.h>
#include <freertos/FreeRTOS.h>
#include <freertos/task.h>
#include "sdkconfig.h"

static char tag[] = "adc1";
```

```

void task_adc1(void *ignore) {
    ESP_LOGD(tag, ">> adc1");
    adc1_config_width(ADC_WIDTH_12Bit);
    adc1_config_channel_atten(ADC1_CHANNEL_6, ADC_ATTEN_6db);
    while(1) {
        int value = adc1_get_voltage(ADC1_CHANNEL_6);
        ESP_LOGD(tag, "value: %d", value);
        vTaskDelay(2000/portTICK_PERIOD_MS);
    }
    vTaskDelete(NULL);
}

```

If we build out on a breadboard a circuit which includes a light dependent resistor such as the following:

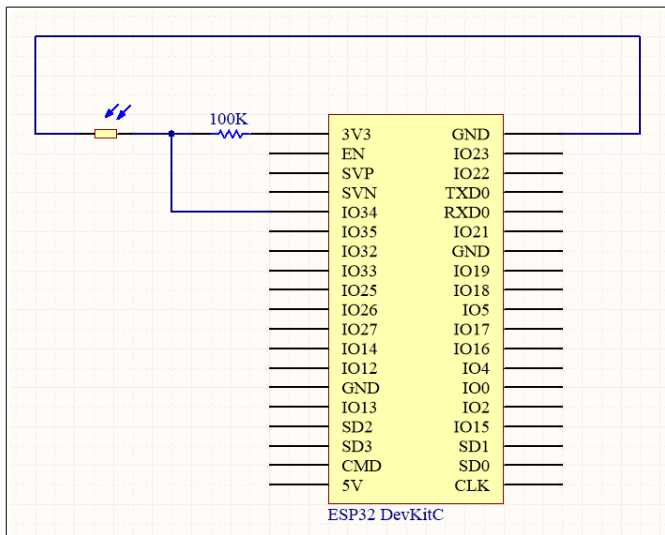
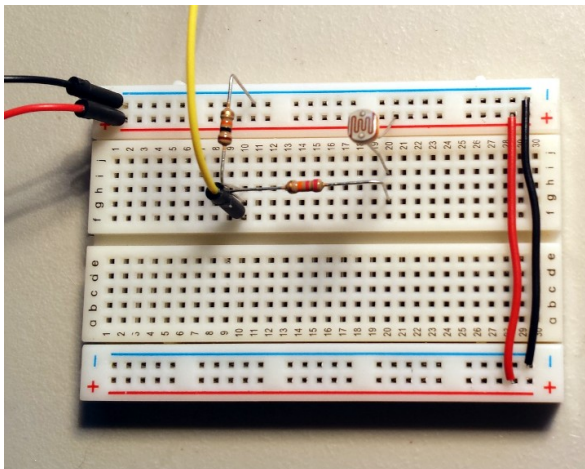

Then when we change the amount of light falling on the resistor, we can see the values change as data is written in the output log. This can be used to trigger an action (for example) when it becomes dark.

Open question: What is the sample rate of the ADC?

Within the ESP32 there are **two** analog to digital converters called ADC1 and ADC2. ADC1 has 8 channels of input while ADC2 has 10 channels of input. It is **vital** to note that we can't use ADC2 while WiFi is also active.

Sorted by GPIO:

GPIO	ADC Channel	DevKit C	Wrover Kit	Notes
GPIO 0	ADC2_CH1	No	No	
GPIO 2	ADC2_CH2		No	
GPIO 4	ADC2_CH0		No	
GPIO 12	ADC2_CH5			
GPIO 13	ADC2_CH4			
GPIO 14	ADC2_CH6			
GPIO 15	ADC2_CH3		No	
GPIO 25	ADC2_CH8			
GPIO 26	ADC2_CH9			
GPIO 27	ADC2_CH7			
GPIO 32	ADC1_CH4			
GPIO 33	ADC1_CH5			
GPIO 34	ADC1_CH6			
GPIO 35	ADC1_CH7			
GPIO 36	ADC1_CH0			Used by hall sensor
GPIO 37	ADC1_CH1			
GPIO 38	ADC1_CH2			
GPIO 39	ADC1_CH3			Used by hall sensor

Sorted by ADC and channel

ADC and Channel	GPIO	DevKitC	Wrover Kit	Notes
ADC1_CH0	GPIO 36			Used by hall sensor
ADC1_CH1	GPIO 37			
ADC1_CH2	GPIO 38			
ADC1_CH3	GPIO 39			Used by hall sensor
ADC1_CH4	GPIO 32			
ADC1_CH5	GPIO 33			
ADC1_CH6	GPIO 34			
ADC1_CH7	GPIO 35			
ADC2_CH0	GPIO 4		No	
ADC2_CH1	GPIO 0	No	No	
ADC2_CH2	GPIO 2		No	
ADC2_CH3	GPIO 15		No	
ADC2_CH4	GPIO 13			
ADC2_CH5	GPIO 12			
ADC2_CH6	GPIO 14			
ADC2_CH7	GPIO 27			
ADC2_CH8	GPIO 25			
ADC2_CH9	GPIO 26			

Note that only a subset of ADC pins and functions are exposed. First, the supplied drivers expose only ADC1.

See also:

- `adc1_config_channel_atten`
- `adc1_config_width`
- `adc1_get_voltage`
- Wikipedia: [Voltage divider](#)
- YouTube: [Analog to Digital with ESP32](#)
- [YouTube: Electronics Basics #27: ADC](#)
- [ESP32 Docs – Analog to Digital Converter](#)

## Digital to analog conversion

The idea behind digital to analog conversion is to output a voltage level that is a linear function of the input value. For example, if we have a maximum desired output of 1V and in an input value that is 8 bits (0-255) then at input value of 0 will produce 0V while an input value of 255 will produce 1V and a value in between will produce a corresponding output.

Output voltage = value / 255

The reference voltage for the ESP32 is 3.3V (the upper voltage) so the actual output voltage becomes

Output voltage = value / 255 \* 3.3

The ESP32 has two DAC channels called Channel 1 and Channel 2. These are connected to GPIO 25 and GPIO 26:

Channel	GPIO pin
Channel 1	GPIO 25
Channel 2	GPIO 26

## Sleep modes

If the ESP32 device is constantly on, then it is constantly consuming current. If the power source is unlimited, then this need not necessarily be an issue however when running on batteries or other finite supply, we may need to minimize consumption. One way to achieve this is to suspend the operation of the device when not in use. When the device is suspended, the notion is that consumption will be reduced. There are three defined sleep modes. These are called modem-sleep, light-sleep, deep-sleep.

By looking at the following table we can get a sense of the abilities in each of these three modes:

Function	Modem	Light	Deep
WiFi	off	off	off
System Clock	on	off	off
Real Time Clock	on	on	on
CPU	on	pending	off
Current consumption	15mA	0.5mA	20µA

The modem-sleep can only be used when the ESP32 is in station mode connected to an access point. The application of this mode is when the ESP32 needs to still perform work but minimizes the amount of wireless transmissions.

The light-sleep mode is the same as modem-sleep but in this case the clocks will be suspended.

In deep-sleep mode, the device is really asleep. Neither CPU nor WiFi activities take place. The device is to all intents and purposes off ... with one exception ... it can wake up at a specified regular interval.



To enter deep sleep mode, we can call `system_deep_sleep()`. This can be supplied with a suspension time. The device will go to sleep and after the interval has elapsed, the device will wake up again. In addition to having a timer, we can also awake from a deep sleep by toggling the value of a signal on a pin.

Write about ...

`esp_deep_sleep_pd_config`

`esp_deep_sleep_enable_ext0_wakeup`

`esp_deep_sleep_enable_ext1_wakeup`

`esp_deep_sleep_start`

`esp_deep_sleep_enable_timer_wakeup`

`esp_deep_sleep`

`RTC_DATA_ATTR` – Specify memory is RTC memory

How do we determine WHY we woke up?

See also:

- [YouTube: ESP32 #18 – Deep sleep API and how to wake up](#)

## Security

The ESP32 has the ability to store the password used to connect to the access point in memory. This means that if one were to physically compromise the device (i.e. steal it) then they could, in principle, dump the flash memory and retrieve your password. You could choose not to cache the password in the clear in flash but instead have your applications "decode" an encoded version that is saved in the flash memory ... this would prevent an obvious retrieval through a simple memory grab. The encoding scheme could be a simple XOR against a magic number (either hard-coded or your own MAC address).

## Working with flash memory

Flash memory provides a non-volatile repository of information that survives a power cycle of the device.

Data contained within flash is stored in units of sectors which are 4096 bytes in size. To write data we can call `spi_flash_write`. To read data we call `spi_flash_read`.

Since writing to flash is performed in units of 4096 bytes, we can not change a single byte by just over-writing it, instead we must retrieve the whole sector, erase the sector and then write back the sector with the changed content. This can take some time to complete and because of this, we may find that a failure is more likely to occur (eg. a loss of power). If a failure occurs after we have erased a sector or during the re-write of the sector, it should immediately become apparent that we will result in an overall corruption of data.

Data reads and writes have to be 4 bytes aligned within flash.

The ESP32 has to be instructed about the size of the flash memory available to it. Attempting to use flash memory addresses that differ from the expected size of flash memory available can result in unexpected results.

When using `esptool.py`, the `--flash_size` flag can be supplied. For `esptool-ck`, the corresponding flag is `-bz`.

The memory map for flash is flexible. A 1 MByte flash has an address range of  
0x00 0000 - 0x0F FFFF

The bootloader loads at 0x00 1000.

The partition table loads at 0x00 8000.

NVS loads at 0x00 9000 to 0x00 EFFF which is 24K.

ESP32 data lives at 0x00 F000 to 0x00 FFFF which is 4K.

The single app loads starting at 0x01 0000. On a typical 4MByte flash space, this would then end at 0x3F FFFF.

Address	Description
0x00 1000	Bootloader
0x00 ????	Unknown
0x00 8000	Partition table
0x00 ????	Unknown
0x00 9000	NVS
0x00 EFFF	
0x00 F000	ESP32 data
0x00 FFFF	
0x01 0000	App
...	

See also:

- esptool
- spi\_flash\_erase\_sector
- spi\_flash\_read
- Cesanta: [ESP8266, flash and alignment](#)

## Working with RAM memory

The heap is the source of dynamically allocated memory requested by the application. We can allocate memory using `malloc()` or `zalloc()`. The first function allocates and returns memory and the second does exactly the same but zeros the memory before returning. When your application logic no longer needs the memory, it can return it back to the heap with `free()`. To determine how much heap size is available, we can call `esp_get_free_heap_size()`. Once we have the memory pointer to allocated storage, we can start to manipulate it through a series of memory commands. The `memset()` command will set a block of memory to a specific value. The `memcpy()` will copy a block of memory to a different block. The `bzero()` function will set the values of a block of memory to zero.

Memory on the ESP32 is made up of a number of components. We have:

- data
- rodata
- bss
- heap

The values of these can be found through the `system_print_meminfo()` function.

When the ESP32 needs to read an instruction from memory in order to execute it, that instruction can come from one of two places. The instruction can be in flash memory (also called `irom`) or it can be in RAM (also called `iram`). It takes less time for the processor to retrieve the instruction from RAM than it does from flash. It is believed that an instruction fetch from flash takes four times longer than the same instruction fetched from RAM. However, on the ESP32 there is less RAM than there is flash. What this means is that you are far more likely to run out of RAM before you run out of flash. When writing normal applications, we shouldn't fixate on having instructions in RAM rather than flash for the performance benefit. The execution speeds of the ESP32s are so fast that if the cost of retrieving an instruction from RAM is blindingly fast then retrieving an instruction from slower flash is **still** blindingly fast.

There are however certain classes of instructions that we might wish to place in RAM rather than flash. Examples of these are interrupt handlers where the time spent in these should always be as short as possible and also function that write to flash.

When we define C functions, we can add an attribute by the name of `ICACHE_FLASH_ATTR`. What this does is place this function in the flash memory address space as opposed to RAM. Specifically, flagging a function with `ICACHE_FLASH_ATTR` tags it as being in the `".irom0.text"` section of code.

**Note:** From a raw technical perspective, `ICACHE_FLASH_ATTR` is a `#define` that maps to:

```
__attribute__((section(".irom0.text")))
```

The mapping of RAM is

0x3FFB 0000	Data Ram
0x3FFF 0000	256K
0x4008 0000	Instruction Ram
0x400A 0000	128K

See also:

- [esptool](#)
- [gen\\_appbin.py](#)
- [Heap management](#)
- [Wikipedia – Data segment](#)

## RAM Utilization

As we write applications using the ESP-IDF, we will likely perform repeated tasks such as creating sockets, creating FreeRTOS tasks and other items. Since anytime we create something that has state, we will be consuming RAM, the question arises of "how much RAM"? The amount of RAM used for common tasks governs just how many instances of that task we can perform without relinquishing previously used memory.

An easy way to determine the current amount of free memory is to use the `esp_get_free_heap_size()` function. This returns the number of free bytes of RAM on the heap. As we use more RAM, the value returned by this function decreases. If we wish to measure how much RAM a particular function might use, one way would be to measure the free RAM before the call and then measure it again after the call and the difference is some indication of how much might be used.

As a base line, after we start an ESP32 application and connect to an access point, I find that the amount of RAM reported back is 191452. In these notes, I'll round that to the nearest 1000 bytes and refer to this as "K" ... for example 191K (not to be confused with common "K" meaning 1024).

Let us start by looking at creating a FreeRTOS task. We commonly use `xTaskCreatePinnedToCore()` for that purpose. The 3<sup>rd</sup> parameter to that function is the stack that is allocated for the new task. This is carved up front from the heap when the task is created. As you can immediately see, creating a stack far larger than needed will immediately waste RAM.

Next, lets look at static RAM usage. This is storage data that is read/write but is declared as static in C application. For example,

```
static char buffer[10*1024];
void myFunc() {
    ...
}
```

In the above, buffer is readable and writeable ... but does NOT reduce the heap size.

However not declaring as static, DOES reduce the heap size:

```
char buffer[10*1024];
void myFunc() {
    ...
}
```

What about the following:

```
void myFunc() {
    char buffer[10*1024];
}
```

```
...  
}
```

In this case, the storage is taken from that of the FreeRTOS task. So the global heap does not decrease but the amount of free space of the FreeRTOS task will diminish.

In C, when we define storage with the "const" modifier, the storage is allocated in flash (.text) as opposed to RAM.

For example:

```
const uint8_t data[100]
```

will be allocated in flash

while:

```
uint8_t data[100]
```

will be allocated in RAM.

Turning to sockets based APIs. The act of creating a listening socket seems to only cost ~700 bytes. Accepting a new connection which itself creates a new socket again only appears to cost about 700 bytes.

- [esp\\_get\\_free\\_heap\\_size](#)

## Heap constructions and management

The end of heap is defined by the symbol `_heap_end`. We will find that defined in the `esp32.ld` linker script. The heap begins at location defined by the symbol `_heap_start` which is defined in the `esp32.common.ld` linker script. Both these symbols are placed in the segment known as `dram0_0_seg`. This symbol is *not* a constant but is instead the next piece of storage immediately following the end of `.bss` RAM usage requested by the application. To see these values, we can run:

```
$ xtensa-esp32-elf-nm -g app.elf | grep _heap_
```

In the output, I found:

```
40000000 A _heap_end  
3ffd3018 A _heap_start
```

This gives us a region of heap from 0x3FFC 3018 to 0x4000 0000 which is about 249K. Don't expect this to be a constant heap size. If you use WiFi, Bluetooth or other ESP-IDF libraries, they will consume more storage. Since these symbols are located in the `dram0_0_seg` and that segments is defined as starting at 0x3FFB 0000, this means that the app reserved about 77K of RAM for its own use.

See also:

- [Heap management](#)

## Heap diagnosis / memory leaks

When you dynamically allocate storage on the heap using either `malloc()` or the C++ `new()` operator, it is your responsibility to return that storage when done. If you fail to perform that task, sooner or later you will run out of heap space and logic will start to fail in ugly ways. Allocating storage and then failing to return it is called a memory leak and they can be appallingly awful to diagnose.

Some possibilities to use to look for memory leaks are to continuously ask for the storage space available using one of:

- `xPortGetFreeHeapSize()`
- `heap_caps_get_free_size()`

In addition, there is a powerful capability called heap tracing. This takes a little bit of work to enable it.

First, we call `heap_trace_init_standalone()` to initialize the heap tracing functions. This takes as input a memory buffer used to hold the trace records. Each record is an instance of a `heap_trace_record` structure. When heap tracing is enabled, each allocation and release of heap data causes a new record to be written / updated.

Each record contains:

- The time stamp that the memory was allocated
- The address of the memory allocated
- The size of the allocated memory
- A call stack trace of the allocating function
- A call stack trace of the releasing function

Tracing is not started until an explicit call to `heap_trace_start()`. The trace can subsequently be stopped by calling `heap_trace_stop()` and resumed by either calling `heap_trace_start()` which resets the trace or `heap_trace_resume()` which simply restarts trace collection.

When tracing is started we can specify a collection mode. There are two choices. The first is that all allocations and releases of storage are logged and the trace record buffer simply keeps being consumed. The other choice is that when a release is performed, the record that was associated with the allocation is removed.

A useful function called `heap_trace_dump()` will log the trace records that have been collected. Here is an example of output:

```
2 allocations trace (500 entry buffer)
100 bytes (@ 0x3ffd4b2c) allocated CPU 0 ccount 0x02a61c84 caller
```

```

0x400d31ab:0x400fd8b7
0x400d31ab: MyTask::run(void*) at
/home/kolban/esp32/esptest/apps/workspace/cpp_utils/main/./task_test_memory.cpp:40
0x400fd8b7: Task::runTask(void*) at
/home/kolban/esp32/esptest/apps/workspace/cpp_utils/components/cpp_utils/./Task.cpp:59
freed by 0x400d31be:0x400fd8b7
0x400d31be: MyTask::run(void*) at
/home/kolban/esp32/esptest/apps/workspace/cpp_utils/main/./task_test_memory.cpp:43
0x400fd8b7: Task::runTask(void*) at
/home/kolban/esp32/esptest/apps/workspace/cpp_utils/components/cpp_utils/./Task.cpp:59
50 bytes (@ 0x3ffd4b2c) allocated CPU 0 ccount 0x02afe950 caller 0x400d31c3:0x400fd8b7
0x400d31c3: MyTask::run(void*) at
/home/kolban/esp32/esptest/apps/workspace/cpp_utils/main/./task_test_memory.cpp:44
0x400fd8b7: Task::runTask(void*) at
/home/kolban/esp32/esptest/apps/workspace/cpp_utils/components/cpp_utils/./Task.cpp:59

50 bytes alive in trace (1/2 allocations)
total allocations 2 total frees 1

```

Some of the above messages are generated by the "make monitor" command. The underlying raw data is:

```

2 allocations trace (500 entry buffer)
100 bytes (@ 0x3ffd4b2c) allocated CPU 0 ccount 0x02a61c84 caller
0x400d31ab:0x400fd8b7
2 allocations trace (500 entry buffer)
100 bytes (@ 0x3ffd4b2c) allocated CPU 0 ccount 0x02a61c84 caller
0x400d31ab:0x400fd8b7
50 bytes (@ 0x3ffd4b2c) allocated CPU 0 ccount 0x02afe950 caller 0x400d31c3:0x400fd8b7
50 bytes alive in trace (1/2 allocations)
total allocations 2 total frees 1

```

See also:

- [Docs: Heap Memory Debugging](#)
- `heap_caps_get_free_size`
- `heap_trace_init_standalone`
- `heap_trace_start`
- `heap_trace_record_t`

### Heap corruption

Within the ESP32 there is RAM. The RAM is used to hold the heap. Keeping it simple, the heap has a start address and an end address. As such, we can imagine it as a contiguous block of memory. So far so good. Now imagine we allocate a chunk of storage from the heap. We will be given a pointer to the start address of the allocated storage. When we allocated that storage, we requested a fixed size so we can assume we will be given a chunk that is at least that big. Since we were given a start address on the return from the request for storage and we know how much RAM we requested, we will also know the end address.



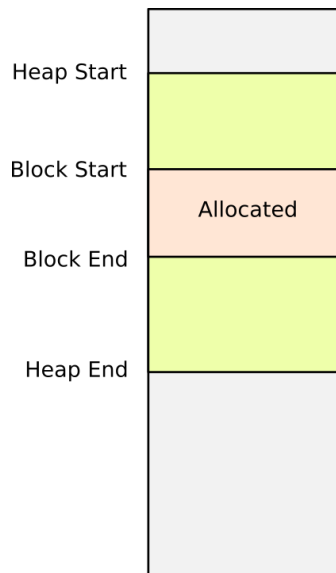

In principle, this means that the RAM from Block Start to Block End is "reserved" for your application. However, this reservation is not policed. When code runs in the ESP32, that code has complete access to all the memory in the complete address range and not just to the memory which has been reserved for it. If a program contains a bug, that bug could merrily step on RAM that it doesn't own without an exception or error being detected when the memory was stepped upon. Later, when a request is made to access memory that was stepped on, the results will be wrong and may result in crashes or, worse, unexpected behavior. At the time of access of the now corrupted RAM, there is no obvious indication of who or when the RAM was corrupted and diagnosis of such problems can become very difficult indeed.

To attempt to give us help when diagnosing heap corruption problems, the ESP-IDF has introduced a number of techniques to help us determine their causes. Within the "`make menuconfig`" tooling, under "Component config -> Heap memory debugging" we will find an entry called "Heap corruption detection". This has three possible settings:

- Basic (no poisoning)
- Light impact
- Comprehensive

One way to detect heap corruption is to place data immediately before and immediately after allocated storage. When light impact is enabled, every time we allocate a block, 4 bytes are additionally reserved before the pointer is returned to us and an additional 4 bytes allocated after the block that is returned to us. The size of the storage used in the heap will thus increase by 8 bytes. These extra bytes are used as "canaries" and are set to constant values. The head canary (the data before our returned pointer) is

0xABBA1234 and the tail canary (the data following the last byte in our usable storage) is 0xBAAD5678.

Thus, the memory layout will be:

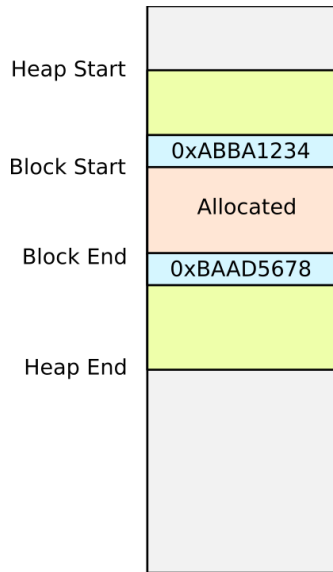

To see how this helps us, remember that the heap manager in the ESP-IDF remembers all the allocations of storage. It maintains a list of all the memory blocks that have been allocated. Upon request, we can ask the ESP-IDF to walk through its list of blocks and for each block, examine the head and tail canary values to ensure that they have the expected content. If they don't, then that is a positive indication that corruption has occurred. Do also realize that if the canary values are intact, we can still have heap corruption if the code that performed the corruption is especially awkward. That code could have modified content after the head canary but before the tail canary and we this technique won't detect that.

Because there is overhead in allocating canaries, they aren't present by default. Setting the configuration to either "Light Impact" or "Comprehensive" will enable them.

When "Light Impact" is enabled, every call to release storage will cause the canary values for the block being released to be examined. If they are found to have changed, an assertion will be raised and the program will stop. Within the message written to the console we will be told the address of the block that was detected to have been corrupted.

We can force an integrity check of all blocks by explicitly calling

`heap_caps_check_integrity()` or `heap_caps_check_integrity_all()`.

Comprehensive enhances light impact. When memory is first allocated, it is filled with the value `0xCE`. If we read data and see `0xCE` in our results, this might be a good

indication that we have read data before it was written to. When we free memory, the memory has the value `0xFE` written into it.

See also:

- [ESP-IDF Docs: Heap Corruption Detection](#)
- `heap_caps_check_integrity`
- `heap_caps_check_integrity_all`

## Using PSRAM

Espressif not only manufactures the ESP32 but they also make a Pseudo SRAM device called the ESP-PSRAM32. This is a 32MBit PSRAM device that supports serial and quad parallel interfaces. 32Mbits provides 4 MBytes of data with 8 bits per byte of data.

To net this out, by attaching one of these devices to the ESP32, we can expand its apparent RAM availability from 512K to 4 MBytes and above.

The page size of the devices is 1K.

Since this device is a serial/quad bus addition to the ESP32 and not architected directly into the ESP32 address bus standard, software running on the ESP32 must provide the drivers and controllers necessary for it to work.

SPI RAM support must be explicitly enable in `make menuconfig` through the option "Support for external, SPI-connected RAM" which can be found in the "ESP32-specific" section.

```
kolban@esp32: ~/git/ESP32_Explorer
File Edit View Search Terminal Help
/home/kolban/git/ESP32_Explorer/sdkconfig - Espressif IoT Development Framework Configuration
> Component config > ESP32-specific

ESP32-specific
Arrow keys navigate the menu. <Enter> selects submenus ---> (or empty submenus ----). Highlighted
letters are hotkeys. Pressing <Y> includes, <N> excludes, <M> modularizes features. Press <Esc><Esc> to
exit, <?> for Help, </> for Search. Legend: [*] built-in [ ] excluded <M> module < > module capable

CPU frequency (240 MHz) --->
[*] Reserve memory for two cores
[*] Support for external, SPI-connected RAM
    SPI RAM config --->
    [ ] Use TRAX tracing feature
    Core dump destination (None) --->
    Number of universally administered (by IEEE) MAC address (Four) --->
(32) System event queue size
(2048) Event loop task stack size
(4096) Main task stack size
(1024) Inter-Processor Call (IPC) task stack size
(4096) High-resolution timer task stack size
    Line ending for UART output (CRLF) --->
    Line ending for UART input (CR) --->
[*] Enable 'nano' formatting options for printf/scanf family
    UART for console output (Default: UART0, TX=GPI01, RX=GPI03) --->
(115200) UART console baud rate
[ ] Enable Ultra Low Power (ULP) Coprocessor
    Panic handler behaviour (Invoke GDBStub) --->
[*] Make exception and panic handlers JTAG/OCD aware
[*] Interrupt watchdog
(300) Interrupt watchdog timeout (ms)
[*] Task watchdog
[ ] Invoke panic handler when Task Watchdog is triggered
(5) Task watchdog timeout (seconds)
[*] Task watchdog watches CPU0 idle task
[*] Hardware brownout detect & reset
    Brownout voltage level (2.1V) --->
    Timers used for gettimeofday function (RTC and FRC1) --->
    RTC clock source (Internal 150kHz RC oscillator) --->
(1024) Number of cycles for RTC_SLOW_CLK calibration
(0) Extra delay in deep sleep wake stub (in us)
    Main XTAL frequency (Autodetect) --->
[ ] Permanently disable BASIC ROM Console

<Select> < Exit > < Help > < Save > < Load >
```

There are additional options that become active once this is checked and can be found under "SPI RAM config":

- Initialize SPI RAM when booting the ESP32
- SPI RAM access method
  - Integrate RAM into ESP32 memory map
  - Make RAM allocatable using heap\_caps\_malloc
  - Make RAM allocatable using malloc() as well
- Type of SPI RAM chip in use
- Set RAM clock speed

- Run memory test on SPI RAM initialization
- Enable workaround for bug in SPI RAM cache for Rev1 ESP32s
- Maximum malloc() size, in bytes, to always put in internal memory.
- Try to allocate memories of WiFi and LWIP in SPIRAM firstly. If failed, allocate internal memory.
- Reserve this amount of bytes for data that specifically needs to be in DMA or internal memory
- Allow external memory as an argument to xTaskCreateStatic

See also:

- [ESP-PSRAM32 Datasheet](#)

## EFUSE

Think of the classic (old?) household fuse. When too much current passes through it, the filament wire inside gets too hot and melts through thus breaking the circuit and electricity stops flowing. If we assign the flow of electricity the value "1" and the inability to flow electricity the value "0", we have a simple boolean value that we can detect. The concept of an EFUSE in the ESP32 is a set of bits that can be electrically set **one time**. Imagine they have a default value of "1", we could select 8 bits and for some of them, pass enough current through them to "blow the fuse". This doesn't harm the ESP32 ... its what these EFUSES were designed to do. As a result, we now have 8 bits of data some of which are "1"s and some of which are "0"s ... in effect ... a byte of data that we set to a fixed value in the hardware. Realize that setting an EFUSE to 0 is a one time operation, you can't subsequently change it back to 1 ... however it does afford us a useful capability. We can imagine ESP32s that have electrically "hard coded" values pre-assigned at manufacturing or distribution time. These could be device identifiers or keys for encryption. Because the values are burned into the device, they can't subsequently be altered or tampered with.

The ESP32 has 1024 bits of EFUSE of which 256 are reserved for the of Espressif for purposes such as the network MAC addresses and chip configuration. However, this still leaves 768 distinct bits at your disposal.

For the tinkerer, there is unlikely to be a compelling reason to use EFUSES, but for the production customer, this is yet another feature you can choose to leverage.

Some of the eFuse entries are used by Espressif. Some of the know ones include:

### EFuse #1

Bits	Description
[0-31]	Low order 4 bytes of MAC address

### EFuse #2

Bits	Description
[0-15]	High order 2 bytes of MAC address

### EFuse #3 - 0x6001a00c

Bits	Description
[12-15]	Silicon revision <ul style="list-style-type: none"><li>• 0x00 = 0</li><li>• 0x08 = 1</li><li>• 0x0c = 1</li></ul>
[9-11]	Package version <ul style="list-style-type: none"><li>• 0 – ESP32D0WDQ6</li><li>• 1 – ESP32D0WDQ5</li><li>• 2 – ESP32D2WDQ5</li><li>• 5 – ESP32-PICO-D4</li></ul>
[1]	Bluetooth present (1=yes)
[0]	Core count <ul style="list-style-type: none"><li>• 1 – single core</li><li>• 0 – dual core</li></ul>

### Button press detection

Button press detection is one of the simplest circuits there is. A schematic may look as follows:

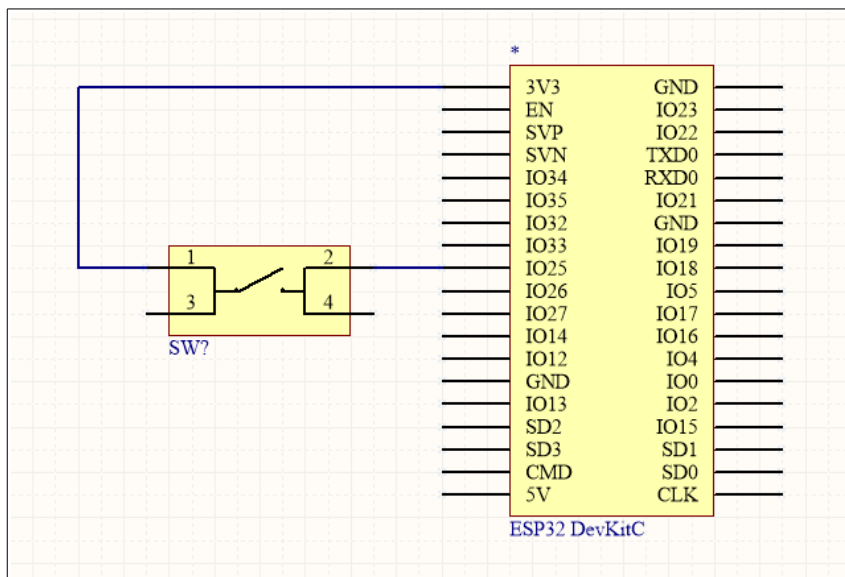

What we see here is that when the button is pressed, the GPIO 25 goes high. When the button is not pressed, there is an open input to GPIO 25. As such, we want to flag GPIO 25 as having a pull-down associated with it so that it has a default signal of low.

Now we can define an interrupt handler to GPIO 25 that will be called when GPIO 25 transitions from low to high. Unfortunately, this is not enough. When a button is pressed, it usually "bounces" for a very small period. This will be interpreted as a series of transitions and hence a series of interrupt handler events. What we want to do is introduce a debounce handler. One way to achieve this is not to trigger our processing when the signal transitions from low to high but to trigger our processing when the signal transitions from low to high **and** the last transition from low to high was at least 50-100 msec ago. When bounces happen, they are usually much shorter than those time periods and can be eliminated.

Here is an example application which illustrates a GPIO interrupt handler:

```
#include <driver/gpio.h>
#include <esp_log.h>
#include <freertos/FreeRTOS.h>
#include <freertos/queue.h>
#include <freertos/task.h>

#include "c_timeutils.h"
#include "sdkconfig.h"

static char tag[] = "test_intr";
static QueueHandle_t q1;

#define TEST_GPIO (GPIO_NUM_25)
```

```

static void handler(void *args) {
    gpio_num_t gpio;
    gpio = TEST_GPIO;
    xQueueSendToBackFromISR(q1, &gpio, NULL);
}

void test1_task(void *ignore) {
    struct timeval lastPress;
    ESP_LOGD(tag, ">> test1_task");
    gettimeofday(&lastPress, NULL);
    gpio_num_t gpio;
    q1 = xQueueCreate(10, sizeof(gpio_num_t));
    gpio_config_t gpioConfig;
    gpioConfig.pin_bit_mask = GPIO_SEL_25;
    gpioConfig.mode          = GPIO_MODE_INPUT;
    gpioConfig.pull_up_en    = GPIO_PULLUP_DISABLE;
    gpioConfig.pull_down_en  = GPIO_PULLDOWN_ENABLE;
    gpioConfig.intr_type     = GPIO_INTR_POSEDGE;
    gpio_config(&gpioConfig);

    gpio_install_isr_service(0);

    gpio_isr_handler_add(TEST_GPIO, handler, NULL);

    while(1) {
        ESP_LOGD(tag, "Waiting on queue");
        BaseType_t rc = xQueueReceive(q1, &gpio, portMAX_DELAY);
        ESP_LOGD(tag, "Woke from queue wait: %d", rc);
        struct timeval now;
        gettimeofday(&now, NULL);
        if (timeval_durationBeforeNow(&lastPress) > 100) {
            ESP_LOGD(tag, "Registered a click");
        }
        lastPress = now;
    }
    vTaskDelete(NULL);
}

```

## GPS

The world is a sphere (hopefully that isn't news to you). We can specify a point on the Earth through a coordinate system known as latitude (lat) and longitude (lng). Given a lat/lng coordinate, we know where we are. The Global Positioning System (GPS) is a technology that allows a GPS receiver to determine its own lat/lng coordinates.

Given a pair of coordinates, for example one coordinate that says where a device is and a second coordinate saying (for example) where we want to eventually be, we can calculate some interesting data such as how far away are we from the target and what compass bearing we need to head to get there.



There are many applications of GPS and it has entered the popular domain. Most cell phones now have in-built GPS receivers such that they can display a map showing your current location. Combine that with a database of driving directions and we have real-time route planners where we mount either a dedicated GPS receiver or a cell phone on our car dashboards and provide destination details and the devices tell us the turns to make.

The Global Positioning System (GPS) is a set of satellites in orbit. They are continually transmitting a very precise time signal. If we have a suitable receiver, we can receive the time signals from some number of those satellites that are over head at any given time. Since the speed of radio transmission is constant and not instantaneous and each satellite is producing an extremely accurate and synchronized time signal, then a signal clock pulse emitted by all satellites at exactly the same time will be received at very slightly staggered times by the receiver as a function of the distance that the signal had to travel through space. This is the same as the distance that the satellite was from the receiver. By receiving enough signals from a sufficient number of distinct satellites and by using complex mathematics, the receiver can then triangulate its own position and thus know where it is on the surface of the Earth.

Putting that in perspective, an electronic module can determine physically where it is. Such modules are now common within your cell phone and within many car dashboards. They are often used in conjunction with mapping software to provide a real-time map showing your location. The accuracy of GPS is commonly about 4 meters.

Devices can be picked up for about the \$12 mark. The unit I worked with is called the GY-GPS6MV2 which is based on the u-blox NEO-6m. The pins on this breakout board are vcc, gnd, RX and TX. This is 5V device. As such, you **must** use a level shifter or voltage divider between the TX pin of the GPS and the RX pin of the ESP32 as the ESP32 can't accept a 5V signal input.

Since it is a UART device, we can test this on a regular PC. If we connect a serial port terminal, we can watch the data be received. The data that comes across is in NMEA format (National Marine Electronics Association). There are various NMEA reader applications freely available which can format the data. The baud rate for the device defaults to 9600 bps.

To test the data, you should really be out-doors or otherwise have an un-obstructed view of the sky. Testing in the interior of a building is basically fruitless as the GPS signals will not penetrate and you will have learned nothing.

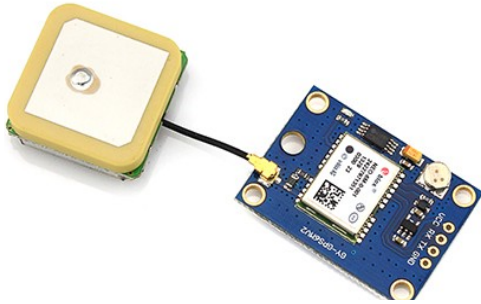

The device has an LED on the circuit that illuminates (flashes green) when a lock has been made.

Here is a sample that reads input from GPIO34 which is connected to the GPS TX:

```
#include "esp_log.h"
#include "driver/uart.h"

static char tag[] = "gps";
void doGPS() {
    ESP_LOGD(tag, ">> doGPS");
    uart_config_t myUartConfig;
    myUartConfig.baud_rate           = 9600;
    myUartConfig.data_bits           = UART_DATA_8_BITS;
    myUartConfig.parity              = UART_PARITY_DISABLE;
    myUartConfig.stop_bits           = UART_STOP_BITS_1;
    myUartConfig.flow_ctrl           = UART_HW_FLOWCTRL_DISABLE;
    myUartConfig.rx_flow_ctrl_thresh = 120;

    uart_param_config(UART_NUM_1, &myUartConfig);

    uart_set_pin(UART_NUM_1,
        UART_PIN_NO_CHANGE, // TX
        34,                 // RX
        UART_PIN_NO_CHANGE, // RTS
        UART_PIN_NO_CHANGE // CTS
    );

    uart_driver_install(UART_NUM_1, 2048, 2048, 10, 17, NULL);

    unsigned char buf[100];
    int size;
    while(1) {
        size = uart_read_bytes(UART_NUM_1, buf, sizeof(buf), 1000/portTICK_PERIOD_MS);
        ESP_LOGD(tag, "Bytes read = %d", size);
        if (size > 0) {
            ESP_LOGD(tag, "%.*s", size, buf);
        }
    }
}
```

## GPS decoding

An open source project on Github called "minmea" provides an excellent parsing library for the protocol generated by these GPS devices. If we read a line at a time from the GPS device and pass that into the parsing routines, we can get data including position, speed and visible satellites. The library compiles 100% cleanly with ESP-IDF as long as one adds:

```
CFLAGS+="-Dtimegm=mktime"
```

to the `component.mk` used to build from the source. The sample snippets supplied with the project proved to be more than sufficient to get a solution going in no time.

At a high level, the protocol exposed by the GPS device is called NMEA 0183. It is composed of one line at a time where each line is considered to be a "sentence". The sentence starts with a designator describing the types of sentence it represents. The minmea parser has support for the following types:

- RMC – Time, latitude, longitude, speed, track, date
- GGA – Time, latitude, longitude, GPS quality, satellite count, altitude
- GSA – Active satellites
- GLL – Latitude, longitude, time
- GST – Error measurements
- GSV – Satellites in view
- VTG – Track and speed

See also:

- Github: [cloudyourcar/minmea](#)
- [NMEA Revealed](#)

## Temperature and pressure - BMP180

The BMP180 module can be found on eBay for less than \$2.00. This device provides both temperature and barometric pressure readings via an I2C bus. It is less expensive than the DHT22 but replaces humidity for air pressure measurement. Arguably, the BMP180 is also easier to use as it does not require as finicky data stream timings. Although common, this device has been superseded by the manufacturer with a later model called the BMP280.

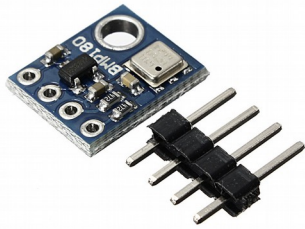

This is a 3V device. The I2C address of the device is  $0x77$ .

The I2C commands to read the device are described in detail in the data sheet. At a high level, we read out a series of EEPROM registers and then ask for both the temperature and pressure. The values returned for these later values need to be arithmetically combined with the EEPROM registers using some equations and the result will be two outputs. A temperature in °C and an air pressure in Pa.

The pin out of the some device types are:

Pin	Label	Description
1	3.3	Not used
2	SDA	I2C SDA
3	SCL	I2C SCLK
4	GND	GND
5	VCC	3.3V

While others have the pin out of:

Pin	Label	Description
1	VIN	3.3V
2	GND	GND
3	SCL	I2C SCLK
4	SCA	I2C SDA

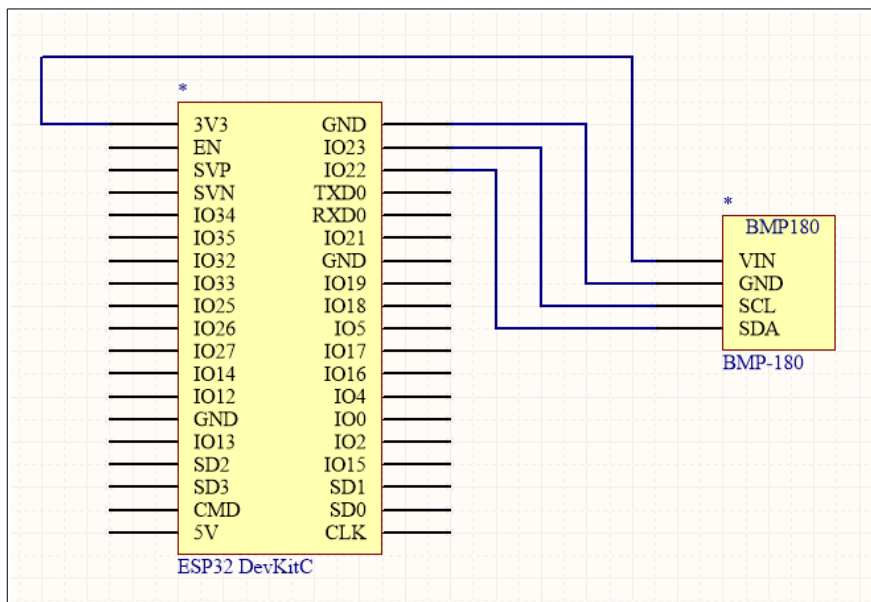

At the driver level, here are the low level details. First we read compensation parameters through I2C. The parameters are identified in the data sheet as 16 bit integers (MSB) read from the following I2C registers:

Parameter	C Type	Registers
AC1	short	0xAA, 0xAB
AC2	short	0xAC, 0xAD
AC3	short	0xAE, 0xAF
AC4	unsigned short	0xB0, 0xB1
AC5	unsigned short	0xB2, 0xB3
AC6	unsigned short	0xB4, 0xB5
B1	short	0xB6, 0xB7
B2	short	0xB8, 0xB9
MB	short	0xBA, 0xBB
MC	short	0xBC, 0xBD
MD	short	0xBE, 0xBF

My understanding (loosely) is that when an instance of a BMP180 is manufactured, there can be slight variances in the construction from one batch of devices from another. These variances are anticipated and have to be accommodated. As such a set of mathematical compensation values are written into an EEPROM contained within the device which provide the details of the specific variants for this exact device. When we ask the device for temperature and pressure values, we then have to also read the

compensation values and apply some mathematics using those plus the obtained readings to achieve the final numbers. Fortunately, we don't have to worry about the actual underlying math, these have been worked out for us by the device designers. However, in our software, we do have to actually perform the math using the compensation values and the sensor read data. The details of the math can be found in the device data sheets and also from the many examples in Github that have already implemented the correct algorithms.

To read a register we perform:

<Start> <Address + WRITE> <Register> <Stop>

<Start> <Address + READ> <Read MSB> <Read LSB> <Stop>

See also:

- [Data sheet](#)
- [Sparkfun – BMP180 Barometric Pressure Sensor Hookup](#)
- [BMP180 I2C Digital Barometric Pressure Sensor](#)
- [Github: Sparkfun/BMP180](#)

### Using the Arduino APIs

Adafruit provide an Arduino library for interacting with the device. This is part of their unified sensor series. It has been tested with the Arduino environment running on the Pi and found to work without issue. Stay away from the similarly named project called `Adafruit-BMP085-Library` as it appears to be buggy.

See also:

- [Adafruit Unified Sensor Driver](#)
- [Adafruit Unified BMP085/BMP180 Driver](#)

### Temperature and pressure - BME280



VIN	3-5VDC input
3V	This is a 3V output from the on-board regulator.
GND	Ground
SCK	SPI Clock / I2C Clock
SDO	SPI MISO
SDI	SPI MOSI / I2C SDA
CS	Chip select (active low)

See also:

- [Adafruit BME290 tutorial](#)
- Github: [roamingthings/esp32-bme280](#)

## NeoPixels

### NeoPixel theory

NeoPixels are LEDs that are driven by a single data line of high speed signaling. Most NeoPixels have a +ve and ground voltage source as well as a data line for input and a data line for output. The output of one NeoPixel can be fed into the input of the next one to produce a string of such LEDs. The input data to the LED is a stream of 24 bits of encoded data which should be interpreted as 8 bits for the red channel, 8 bits for the green channel and 8 bits for the blue channel. Each channel can thus have a luminance value of between 0 and 255. By mixing the values for each of the channels together, you can color an LED to any color you may choose. After sending in a stream of 24 bits, if we send in a second stream of 24 bits quickly after the first stream, the second stream is "pushed" through to the next LED in the chain. This can be repeated as far as desired. If we pause sending in data, the current values are "latched" into place and each LED then remembers its own value.

The timings of the data signals for these LEDs can be quite tricky but fortunately great minds have already built fantastic libraries for driving them correctly so we need not concern ourselves with these low level timings and can instead concentrate on devising interesting projects and purposes to which the LEDs can be placed. There are a number of different types of these LEDs with the most common ones being known as WS2811, WS2812 or PL9823.

NeoPixels are usually 5V devices but check the specs carefully. Since NeoPixels draw a lot of current (60mA each), do **not** try and power them from low current sources. You also need to be careful when sending signals into them and getting their polarity correct. If you mess up, they are unforgiving. I recommend buying more instances than you will need in case you make a mistake.



The eight piece strip is labeled CJMCU-2812-8. It has 4 pins at each end of the strip labeled:

Label	Description	Color
GND	Ground.	Yellow
DIN/DOUT	One side is DIN the other DOOUT ... this means that the strip is polarized. These are the control data input and output lines.	Green
4-7VDC	Source voltage.	Red
GND	Ground.	Yellow

The data is sent as 24 bits in Green/Red/Blue order (GRB). Note that this is NOT RGB. The format of the data uses NZR (Non-return-to-zero) encoding.

Specifically, the logic 0 and logic 1s are encoded as following.

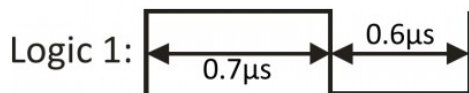

Both bits correspond to a transition from high to low to high again but the duration at which they are held indicates the encoding of a 1 or 0.

The data send to an individual device is 24 bits corresponding to 8 bits of color data for each of the RGB components. The 8 bits identify the brightness of each of the channels with 1 being lowest and 255 being brightest.

Various diagrams show the timing as follows:



**Sequence chart:**

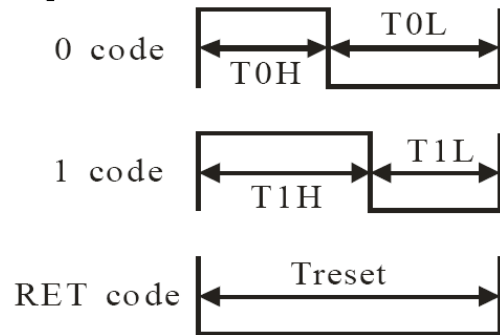

Various data sheets show different timing values in micro seconds:

Device	T0H	T0L	T0	T1H	T1L	T1
WS2811	0.5	2.0	2.5	1.2	1.3	2.5
WS2812	0.35	0.8	1.15	0.7	0.6	1.3
WS2812B	0.4	0.85	1.25	0.8	0.45	1.25
PL9823	0.35	1.36	1.71	1.36	0.35	1.71

As we see, for a WS2812B, the "width" of a bit is about 1.25 microseconds. For a full pixel, this would be 24 bits or 30 microseconds. Thinking of it another way, that would be over 33,000 pixels that could be updated per second.

The data is sent high bit first.

For testing circuits, I like to use PL9823. These can be had on eBay for between 25 cents and 35 cents each. It is physically easy to work with and in the event of a design or assembly error, they are cheap enough to shrug off damage and throw away ones you damage or break.



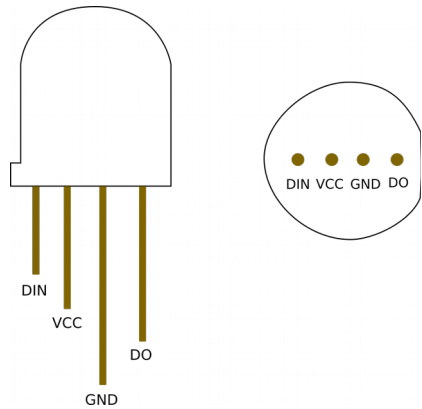

See also:

- [WS2812 Data Sheet](#)
- [PL9823 Data Sheet](#)
- [Use a \\$1 ATTiny to drive addressable RGB LEDs](#)
- [Adafruit NeoPixel Uberguide](#)
- [NeoPixels Revealed: How to \(not need to\) generate precisely timed signals](#)

### NeoPixels and the ESP32

If we take the WS2812 as an average device, we see that we need to create timings on the order of 400ns. That is much too short an interval to perform in code logic so we will need hardware support to achieve the task. Fortunately, the RMT driver gives us exactly what we need. If we look at the base clock, we find that it has a maximum resolution of 80MHz which is a resolution of 12.5ns. In fact if we use a divisor of 8 we then have a granularity of 100ns which puts us right on target. Thus to send a 0, we would transmit high for 400ns and low for 800ns and to send a 1 we would transmit high for 800ns and low for 500ns. A latch is low for 50us (50,000ns).

A sample C++ class for driving NeoPixels from the ESP32 is available here:

<https://github.com/nkolban/esp32-snippets/tree/master/hardware/neopixels>

See also:

- [RMT – The Remote Peripheral](#)

### APA102

The APA102 is a relatively new three color RGB device. This is a 5V device.

Each module has 6 pins:

DI – Data in	DO – Data out
CI – Clock In	CO – Clock out
GND	VCC

The data is set by sending a start frame which is 32 bits of 0 followed by 32 bits of LED data repeated for each LED in the chain and concluding with an end frame which is 32bits of 1s. It isn't clear why there needs to be a terminator of all ones as this would appear to clash with a pixel of maximum brightness and pure white.

The encoding of the LED color is:

111	Brightness	Blue	Green	Red
3	5	8	8	8

A convention for color coding is:

- Red – Vcc
- Black – GND
- Green – Data In
- Yellow – Clock In

See also:

- [Adafruit DotStar](#)
- [APA102 Datasheet](#)
- [Github: adafruit/Adafruit\\_DotStar](#)
- [APA102 aka "Superled"](#)

## LED 7-Segment displays

The 7-Segment display is an LED device that is composed of 7 line segments that can be arranged to display numbers. There is also an eighth LED that is used to display a decimal point. The makeup of the segments are shown in the following diagram:

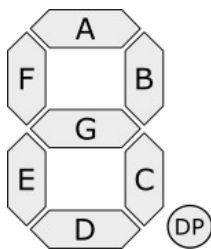

Although a seven segment display looks "quite dated" they should not be discounted. If what one wants to do is show a numeric value that can be read from a distance and which is very cheap to use, then this device may be just perfect.

It is common to see 7-segment displays used in conjunction with the MAX7219 or MAX7221 ICs. These ICs know how to drive up to eight multiplexed 7-segment

displays with data received over an SPI bus. As such, the ESP32 can send in an SPI signal and these devices can easily display the results.

See also:

- Wikipedia – [Seven-segment display](#)

### MAX7219/MAX7221 - Serial interface, 8-digit, led display drivers

The MAX7219 and MAX7221 are ICs that can drive up to eight digits of 7 segment displays or drive an 8x8 matrix of LEDs. The LEDs should be common cathode. The device works using the SPI protocol.

This is a 5V device. A 3.3V device known as the MAX6951 is also available. Note that the device is input-signal only. As such, there should be no issues connecting it to any of your ESP32 pins.

The physical layout of the IC looks as follows:

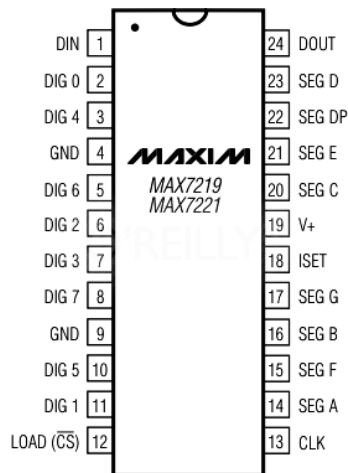

Place a 10uF electrolytic and 0.1uF ceramic as close to the device as possible.

For 7-Segment displays, these should be common cathode.

The pin out of the IC is shown in the next table.

Name	Pin	Description
DIN	1	Serial data input (MOSI). Data loaded on clock rising edge.
DIG0-DIG7	2, 3, 5-8, 10, 11	Connections to each of the eight digits.
GND	4, 9	<b>Both</b> ground pins must be connected.
$\overline{CS}$	12	Chip select. Data is loaded into serial register while $\overline{CS}$ is low and latched on $\overline{CS}$ rising edge. Unlike other SPI devices where you can leave the CS enabled, this device needs to actively control the CS.
CLK	13	The clock for the serial data,
SEGA-SEGG, DP	14-17, 20-23	Connection to each of the eight segments in a digit.
ISET	18	Connect to $V_{DD}$ through a resistor to set peak segment current. The resistor values are shown in a following table. The resistor is referred to as $R_{SET}$ . The current sent to a segment is 100 times the current entering ISET.
$V_{DD}$	19	5V
DOUT	24	Serial data output for daisy chaining.

#### Data format:

15	14	13	12	11	10	9	8	7	6	5	4	3	2	1	0
X	X	X	X	Register Address				Data							

#### Registers

Name	Bits	Description
Shutdown	0b1100 (0xc)	Should the device shutdown the display <ul style="list-style-type: none"> <li>• 0 – Shutdown. In shutdown mode the display is blanked.</li> <li>• 1 – Normal</li> </ul>
Decoding	0b1001 (0x9)	How is decoding performed? <ul style="list-style-type: none"> <li>• 0x00 – No decoding for digits 7-0</li> <li>• Corresponding bit on – Code B decode for digit (0-9, E, H, L, P and '-')</li> </ul>
Intensity	0b1010 (0xa)	The brightness of the display 0000 – 1111 with 0000 being minimum and 1111 being maximum.
Scan Limit	0b1011 (0xb)	Controls how many digits are to be included in the scan multiplexing. <ul style="list-style-type: none"> <li>• 0b0000 – Digit 0</li> <li>• 0b0001 – Digits 0, 1</li> <li>• 0b0010 – Digits 0, 1, 2</li> <li>• 0b0011 – Digits 0, 1, 2, 3</li> <li>• 0b0100 – Digits 0, 1, 2, 3, 4</li> <li>• 0b0101 – Digits 0, 1, 2, 3, 4, 5</li> <li>• 0b0110 – Digits 0, 1, 2, 3, 4, 5, 6</li> <li>• 0b0111 – Digits 0, 1, 2, 3, 4, 5, 6, 7</li> </ul>
Display Test	0b1111 (0xf)	Test the display. <ul style="list-style-type: none"> <li>• 0 – Normal operation</li> <li>• 1 – Test mode</li> </ul>
No-Op	0b0000 (0x0)	Don't perform any task. Useful for passing data through the device to a daisy chained instance.
Digit 0	0b0001 (0x1)	Set the value for digit 0.
Digit 1	0b0010 (0x2)	Set the value for digit 1.
Digit 2	0b0011 (0x3)	Set the value for digit 2.
Digit 3	0b0100 (0x4)	Set the value for digit 3.
Digit 4	0b0101 (0x5)	Set the value for digit 4.
Digit 5	0b0110 (0x6)	Set the value for digit 5.
Digit 6	0b0111 (0x7)	Set the value for digit 6.
Digit 7	0b1000 (0x8)	Set the value for digit 7.

The value of the  $R_{SET}$  resistor can be seen in the following table:

LED Forward Current	1.5V	2.0V	2.5V	3.0V	3.5V
10ma	66.7k	63.7k	59.3k	55.4k	51.2k
20ma	29.8k	28.0k	25.9k	24.5k	22.6k
30ma	17.8k	17.1k	15.8k	15.0k	14.0k
40ma	12.2k	11.8k	11.0k	10.6k	9.7k

Anodes of the LEDs must be connected to the `SEGx` lines while cathodes must be connected to the `DIGx` lines.

There are boards available which have MAX7219's already mounted and ready for work including 8x8 LED matrices. These are much easier to work with than wiring together a rats-nest of links. The boards cost less than \$2 an instance. The pin out from the board are:

Pin	Label	Description
1	Vcc	+ve
2	GND	Ground.
3	DIN	Data in.
4	CS	Chip Select.
5	CLK	Clock.

Here is an image of such a board:

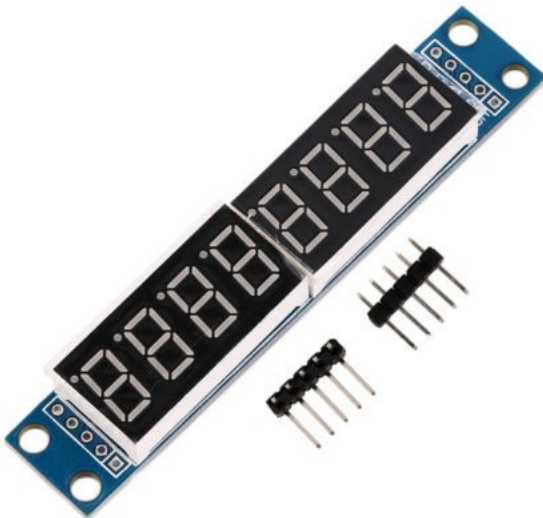

In addition to these 7-segment LEDs, there are also 8x8 matrix boards that use the same MAX7219 and have the same pin outs.

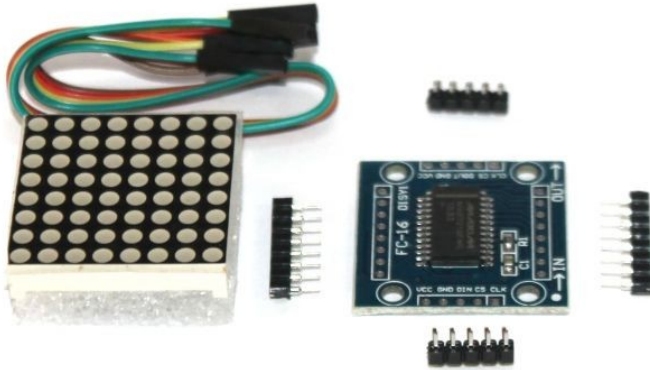

See also:

- [MAX7221 Home Page](#)
- [Drive MAX7219/MAX7221 with common anode displays](#)
- Arduino – [The MAX7219 and MAX7221 LED drivers](#)
- Github: Arduino – [wayoda/LedControl](#) library
- Instructables – [16x8 LED dot matrix with MAX7219 module](#)
- YouTube – [ESP32 Technical Tutorials: Driving the MAX7219](#)
- YouTube – BrainyBits - [How to use MAX7219 Dot LED matrix with Arduino](#)
- YouTube – [Scrolling text using the MAX7219 and an Arduino](#)
- YouTube – [Arduino tutorial: LED Matrix red 8x8 64 Led driven by MAX7219 \(or MAX7221\) and Arduino Uno](#)

## The U8g2 library

Available on Github is a rather good library for driving monochrome displays. The library is called U8g2. See the links for the web page. There are actually two libraries. One is called U8g2 which requires a memory buffer in the ESP32 to hold the raster of the image and a second library called U8x8 which is text only and needs no raster buffer. In order to work with the library, you need to know the controller type of the graphics device plus the size of the display in pixels. There are separate constructors for each of the distinct supported combinations. The supported combinations can be found [here](#).

The primitive drawing commands are bound to C functions and include filled rectangles, frames, circles, ellipses, text and much more. Tests I have performed show that it worked fine with an SSD1306.

When we think of a display, we should think of it as a rectangular array of pixels of a fixed width and height. It is common to keep a data representation of what should be shown on the display in RAM and this is known as a frame buffer. A change in the RAM which is then pushed to the display causes an update of the display. If we set a bit in



the frame buffer to be 1 and then cause the frame buffer to be displayed, the corresponding pixel will illuminate.

The manufacturers of distinct displays have chosen distinct technologies for representing pixel data and how that pixel data is pushed to the displays. For example, some vendors have 8 bits of data as the vertical set of pixels top to bottom while others have them going from left to right. The U8g2 library attempts to normalize the story by providing logical primitives that are then mapped to the correct data streams and frame buffer updates appropriate for the specific device.

The U8g2 library is MCU agnostic. That means that it knows nothing about ESP32 and everything about displays. To have the library work with the ESP32 we need a hardware abstraction level or HAL. The HAL maps logical requests issued by the library such as set a GPIO pin from high to low or send data via SPI to the actual APIs that are needed by the target platform, in our case an ESP32. A set of HAL routines for the ESP32 has been written. These routines can be compiled and linked with the U8g2 library and the ESP32 application to provide ESP32 support.

See also:

- [Github: olikraus/u8g2](#)
- [U8g2 API reference](#)
- [YouTube – ESP32 Technical Tutorials: Displays and the U8g2 library](#)

### **LCD display - Nokia 5110 - PCD8544**

This little LCD screen has a resolution of 84x48 pixels and can be picked up on eBay for about \$3. The underlying IC is the PCD8544 but it is also known as the Nokia 5110. The device is driven by an SPI interface. Since the device is input (to the device) only, we need not be concerned with overloading ESP32 input pins.



The pins on the board are:

Pin	Description
1	V <sub>cc</sub> – 6V – 8.5V
2	GND
3	$\overline{\text{SCE}} / \overline{\text{CS}}$ – Chip enable. A low edge indicates start of data transmission.
4	$\overline{\text{RST}}$ – Reset the device. Active low.
5	$\overline{\text{D/C}}$ – Input is Data (1) or command (0).
6	DN <MOSI> – The SPI MOSI
7	SCLK – The SPI clock. The maximum permissible clock speed is 100KHz.
8	Backlight LED

The data sheet explains well the sequence of commands that need to be sent to drive the display however, as always should be the case, you should look to be leveraging what already exists rather than re-inventing for the sake of it. The fantastic folks at Adafruit with their Adafruit GFX graphics library have provided an Arduino library for working with the device. This library has been ported to work with the ESP32. As such, all you need are copies of those libraries and you are ready to go.

An example set of pin mappings might be:

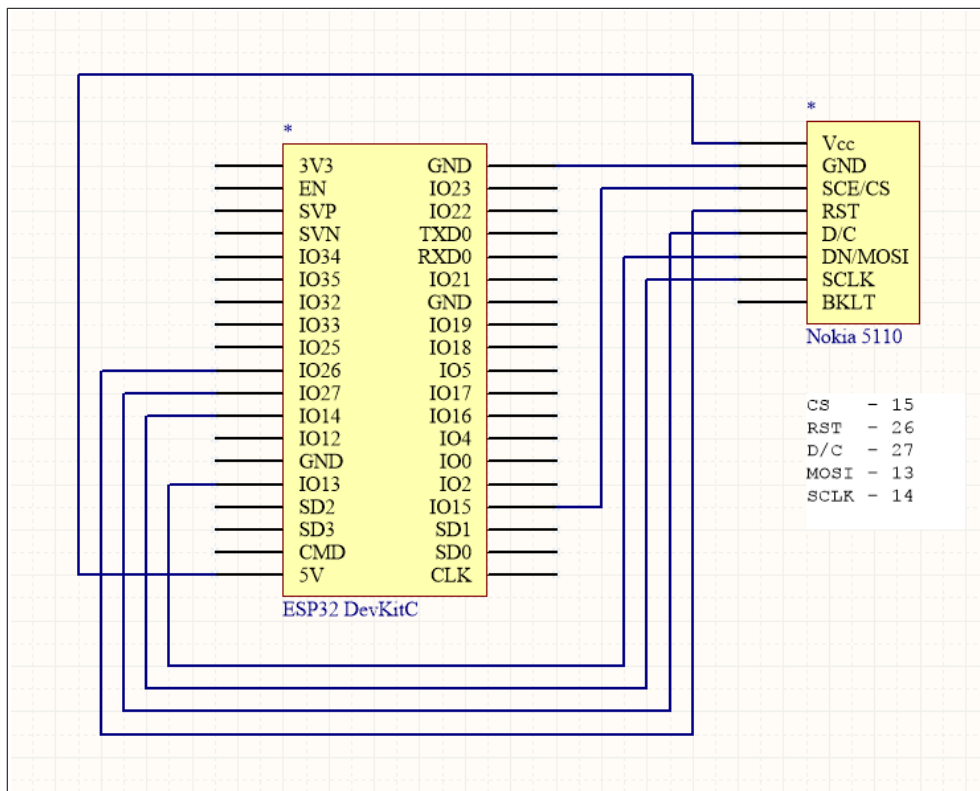

See also:

- [Data Sheet](#)

## OLED 128x32, 128x64 - SSD1306

Another screen device that is readily available are the small OLED displays. These are based on an IC called the SSD1306 and can be found on eBay using that phrase as a search. The price for an instance seems to range between \$5 and \$12.

The device can operate at either 3.3V or 5V.



The typical resolution is either 128x32 or 128x64 pixels. At a 6x8 character resolution, this would give us 4 or 8 rows of 21 (and a bit) columns (128 pixels/6 pixels per column = 21.333) .

The pin out on the SPI device is:

Pin	Description
1	GND – Ground
2	VCC – 3.3v or 5.0v
3	D0 – Clock
4	D1 – MOSI
5	RES – Reset
6	DC – Data / Command
7	CS – Chip Select

The pin out on the I2C device is:

Pin	Description
SDA	Data
SCL	Clock
VCC	3.3V
GND	GND

The I2C address is 0x3C or 0x3D.

The device can support a variety of protocols including 3 or 4 wire SPI and I2C. Depending on the model / variety of the board it you obtain, it is likely that it will be physically configured in one particular mode. Examine the board and the associated documentation.

Again the excellent Adafruit folks have produced libraries for the Arduino which have been ported to the ESP32.

A potential wiring diagram is as follows:

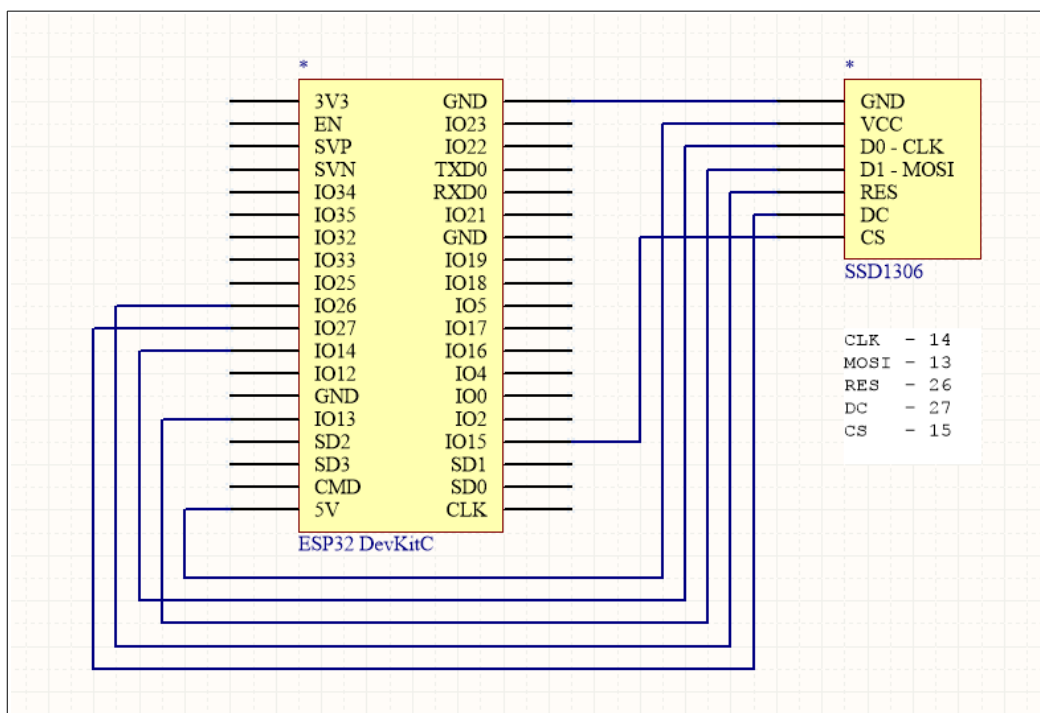

This display has also been tested with the U8g2 lib and worked as advertised.

See also:

- [The U8g2 library](#)
- [SSD1306 Data Sheet](#)
- [Github – Adafruit SSD1306](#)
- [Adafruit – Monochrome OLED breakouts](#)
- [ESP32 - Adafruit\\_SSD1306-Library](#)

## TFT displays

An excellent library for working with TFT displays has been made by Internet user lobaris. His library works very nicely and is available for download from Github. Included within it is a demonstration program that drives the display for testing.

The display devices supported are:

- ILI9341
- ILI9488
- ST7789V
- ST7735
- ST7735R
- ST7735B

Major functions are:

- TFT\_drawPixel
- TFT\_drawLine
- TFT\_drawFastVLine
- TFT\_drawFastHLine
- TFT\_drawLineByAngle
- TFT\_drawRect
- TFT\_fillRect
- TFT\_drawRoundedRect
- TFT\_fillRoundedRect
- TFT\_drawCircle
- TFT\_fillCircle
- TFT\_drawEllipse
- TFT\_fillEllipse
- TFT\_drawTriangle
- TFT\_fillTriangle
- TFT\_drawArc
- TFT\_drawPolygon

- TFT\_print
- TFT\_getStringWidth
- TFT\_clearStringRect
- TFT\_fillScreen
- TFT\_setRotation – Set the screen orientation
  - PORTRAIT
  -
- TFT\_invertDisplay
- TFT\_compare\_colors
- TFT\_display\_init() – Initialize the display
- TFT\_PinsInit() - Initialize the GPIO pins of the ESP32 ready for driving the display.
- TFT\_setFont – Set the font to use

See also:

- [Github – loboris/ESP32\\_TFT\\_library](#)

### **Ambient light level sensor - BH1750FVI**

An interesting little module incorporating the BH1750FVI (aka GY-302) is available from a number of suppliers on eBay. Simply put, this device measures the amount of light falling upon it and returns a measurement of that value. While that can be done through a simple light dependent resistor and an analog to digital converter, this device is arguably easier to use as the device attaches to an I2C bus. In addition, the device characteristics are to sense light in the same spectrum as the human eye, something I'm not sure is true for a simple light dependent resistor solution. Further, the device has 16bits of sensitivity as compared to a maximum of 12 bits of sensitivity found the ESP32 ADC.

This is a 3.3V device, do **not** attempt to power fro 5V.

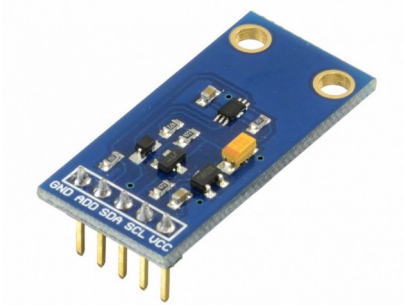

Pin	Function
VCC	3.3V
GND	Ground
SCL	I2C Clock
SDA	I2C Data
ADDR	Address select

The following commands can be sent by an I2C write:

Value	Function
0x00	Power down
0x01	Power on
0x07	Reset
0x10	Mode High res
0x11	Mode High res 2
0x13	Mode Low res
0x20	One time Mode High res
0x21	One time Mode High res 2
0x23	One time Mode Low res

The I2C bus address of the device is 0x23.

Here is a simple schematic illustrating the a wiring of the device.

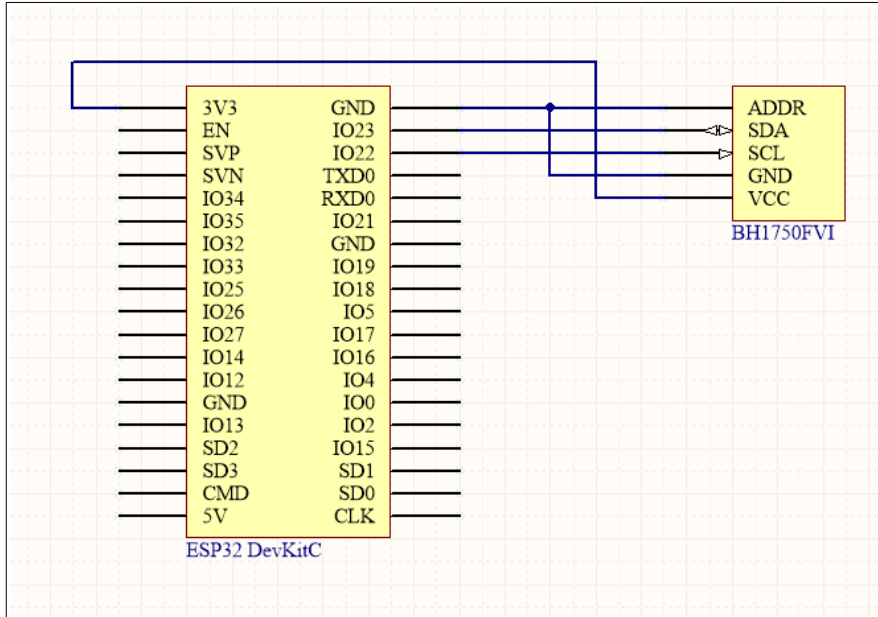

See also:

- [Rohm BH1750FVI – Data sheet](#)
- [Wikipedia – Lux](#)
- [YouTube: ESP32 Technical Tutorial – Ambient light levels](#)

## Ambient light and proximity sensor

The APDS-9930 is an ambient light and proximity sensor. This is a 3.3V device using I2C.

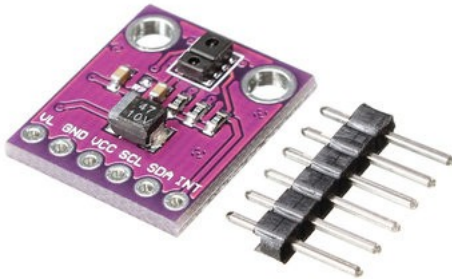

Module pins:

VL	IR LED power
GND	Ground
VCC	3.3V
SCL	I2C Clock
SDA	I2C Data
INT	Interrupt



See also:

- [Data sheet](#)

## Infrared receivers

Infrared is a frequency range of light that is not visible to our eyes. If we look at a source of infrared light, we simply won't see any emissions even though they are actually being emitted. There are LEDs available that can generate infra-red frequency light and there are corresponding detectors that can measure the incoming amount of infrared light. Since these light sources don't distract us, we can use them for signaling by having an infra-red transmitter send pulses of light to an infra-red receiver. This is precisely how many home remote control hand-sets work for devices such as TVs and music systems.

What we might want to do is to control the ESP32 remotely using an infra-red hand-set.

There are many infra red hand-sets that we can use that can be purchase on eBay for a few dollars. Alternative we can use any hand-set from an old TV.



We will also need to wire in an infra-red receiver circuit to our ESP32.

With the transmitter (hand-set) and the receiver (electronics connected to ESP32) we are about ready to go. The next thing we have to consider is how to receive the data transmitted and how to decode it.

One of the more popular infrared receivers is the VS1838B.

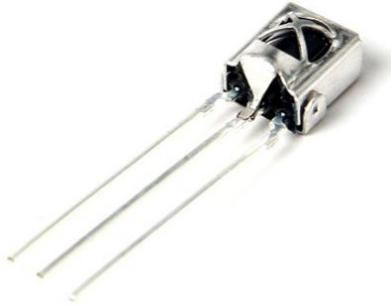

The pin out of this device (from left to right facing the front):

Pin	Function
1	Data
2	GND
3	Vcc 2.7-5.5V

This device is able to receive at a frequency resolution of 38KHz.

If we connect the data out to a logic analyzer and then apply an IR signal from a controller, we can see the incoming pulse-train. For example:

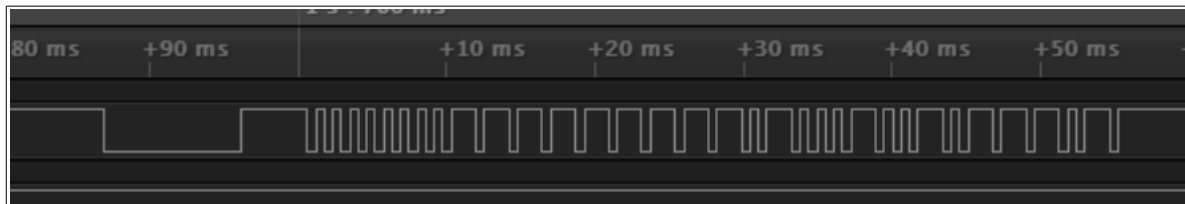

Obtaining the data from an IR receiver LED is supported natively by the hardware of the ESP32 using the RMT peripheral. It can be configured to watch for pulse trains and return us an array of items where each item represents the duration a signal is low and the duration a signal is high. From this data we obtain very accurate representations of the IR data. However, there are still puzzles to be solved. Most remote controls have multiple buttons ... power on, power off, volume up, volume down etc. Each button performs a distinct function and hence must be sending a distinct pattern of data to represent the function of that button. As such, not only do we want to detect that a pulse train has arrived, we also need to decode its content. It would have been nice if there had been one format for all remote controls, but sadly, that isn't the case. There are in fact quite a few protocols made by different vendors. The protocols include NEC, Sony SIRC, Phillips RC5, Phillips RC6 and more.

Let us use the NEC protocol as an example. A train starts with a 9ms mark followed by a 4.5ms space. It is safe to assume that the durations measured won't be exactly 9ms and 4.5ms ... so we need to accommodate tolerance to the values actually measured.

See also:

- [SB-Projects IT Remote Control Theory](#)
- [NEC protocol](#)

## RFID MFRC522

Perhaps you have stayed at a modern hotel recently. In some cases when they give you the key-card at the reception desk and you get to your door, you may find that you don't actually insert the card in a slot but instead bring it close to the door lock in order to gain entry. Maybe you are an employee at a big corporation where you wear an ID badge and in order to gain entry into the building, you bring your card near a turnstile or door badge reader.



In other cases, we find that products contain identification tags that can be used at check-out or during stocking to determine information about them. These packages can then be scanned to learn more:



What these have in common is the inclusion of an RFID.

Radio frequency identification (RFID) is the notion that we can have a receiver that is listening for low power radio frequency emissions. When a device that emits a signal on the correct frequency is brought in range, the receiver is triggered. Typically, the range

of such a device is only a few inches and the transmitter itself is a passive device ... meaning it has no power source within it but is instead activated by the receiver itself transmitting enough energy for the transmitter to modulate a response. We see these kinds of devices in hotels when they can be used to open doors. Instead of inserting a physical key or even a key card into a slot, we simply bring the card "near" or "tap it" on the lock and the door opens.

The transmitters can also transmit small amounts of information to the receiver and that information can be used allow or disallow access.

For our purposes, we can use the MFRC522 receiver and associated cards and transmitters. If you see the phrase "PICC" ... this stands for "proximity integrated circuit card" which is the formal name for the RFID cards and tags.

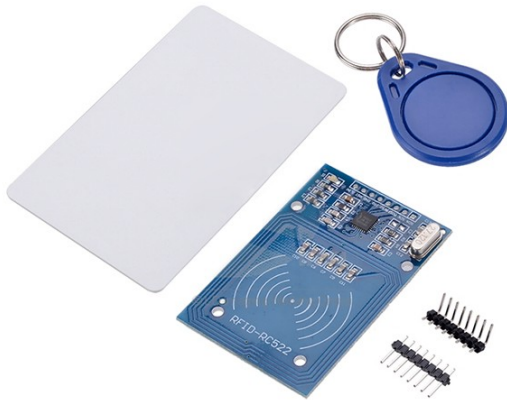

A receiver and some transmitters can be picked up on eBay for under \$3.

The MFRC522 is a 3.3V device. Do not try and power it from the 5V source. The cards can hold up to 1K bytes of data and have a range of 1cm or 2cm. The communication between the receiver and the ESP32 is via the SPI protocol.

The pin out on the device is:

Pin	Label	Description
1	3.3V	Source
2	RST	Reset
3	GND	Ground
4	IRQ	Can be left unconnected
5	MISO	Master In / Slave Out
6	MOSI	Master Out / Slave In
7	SCK	Clock
8	SDA	Slave select or SDA. Quite why this is labeled SDA is a mystery as that is an I2C term and this board only supports SPI. It does seem to serve as a slave select.

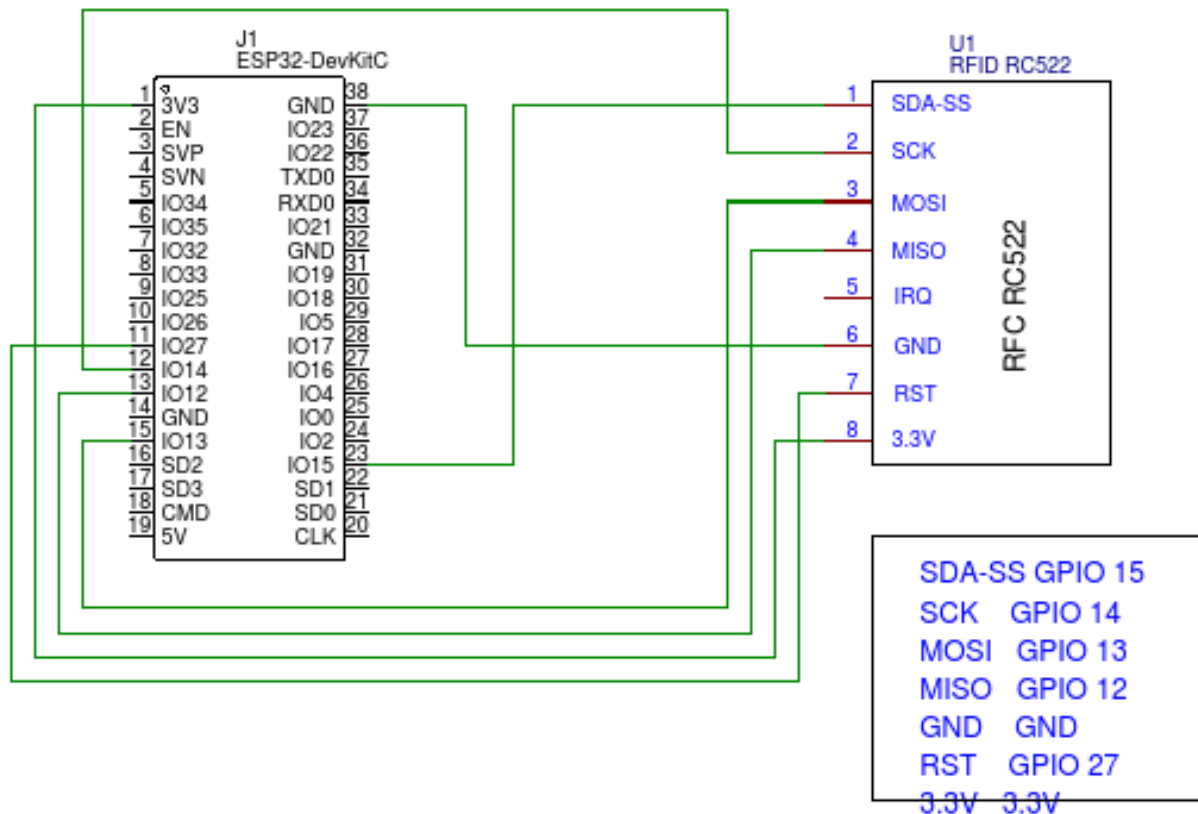

The data on the card is broken out into sectors, blocks and bytes. There are 16 sectors identified as 0 through 15. Each sector contains 4 blocks. These are identified as 0 through 3. Each block contains 16 bytes. If we look at the total ... 16 sectors \* 4 blocks \* 16 bytes we end up with 1024 bytes (or 1K).

See also:

- Wikipedia – [Radio-frequency identification](#)
- [MFRC522 Data sheet](#)
- YouTube: [Tutorial:Using a RFID Card Reader with the Arduino](#)
- YouTube: [ESP32 #33: RFID Read and Write with MFRC522 Module](#)
- Github: [miguelbalboa/rfid](#) – Arduino library for MFRC522

### MFRC522 - Low levels

This is a 3.3V device, you will ruin it if you attempt to connect it to a 5V source.

The chances are that this section will be of little value to you. Most of the components I work with have relatively simple interfaces but this one has a lot of options and unless one wants to become a deep student of the device, it is likely that one of the pre-existing libraries will be what is most beneficial. However, it is my intent that, over time, I will read the data sheet carefully and combine that with the current known open source implementations and try and provide at least a readers guide to understanding the protocols and algorithms.

The device has a lot of registers:

Address	Name	Description																
0x00	Reserved	Reserved for future use.																
0x01	CommandReg	Starts and stops command execution.																
0x02	ComlEnReg	Control of interrupt requests.																
0x03	DivlEnReg	Interrupt request bits.																
0x04	ComIrqReg																	
0x05	DivIrqReg																	
0x06	ErrorReg	Error status of last command executed.																
0x07	Status1Reg	Status register.																
0x08	Status2Reg	Status register.																
0x09	FIFODataReg																	
0x0a	FIFOLevelReg	Number of bytes in FIFO queue.																
0x0b	WaterLevelReg	Threshold for FIFO queue under and over flow warning.																
0x0c	ControlReg	Misc control bits.																
0x0d	BitFramingReg	Bit oriented frames.																
0x0e	CollReg	Collision detection handling.																
0x0f	Reserved	Reserved for future use.																
0x10	Reserved	Reserved for future use.																
0x11	ModeReg	General transmit and receiver controls. <table border="1" data-bbox="613 1415 1425 1780"> <thead> <tr> <th>Pin</th> <th>Name</th> </tr> </thead> <tbody> <tr> <td>7</td> <td>MSBFirst</td> </tr> <tr> <td>6</td> <td>N/A</td> </tr> <tr> <td>5</td> <td>TxWaitRF</td> </tr> <tr> <td>4</td> <td>N/A</td> </tr> <tr> <td>3</td> <td>Polarity of MFIN</td> </tr> <tr> <td>2</td> <td>N/A</td> </tr> <tr> <td>1:0</td> <td>CRC Preset</td> </tr> </tbody> </table>	Pin	Name	7	MSBFirst	6	N/A	5	TxWaitRF	4	N/A	3	Polarity of MFIN	2	N/A	1:0	CRC Preset
Pin	Name																	
7	MSBFirst																	
6	N/A																	
5	TxWaitRF																	
4	N/A																	
3	Polarity of MFIN																	
2	N/A																	
1:0	CRC Preset																	
0x12	TxModeReg	Transmit rate. <table border="1" data-bbox="613 1829 1425 1877"> <thead> <tr> <th>Pin</th> <th>Name</th> </tr> </thead> <tbody> </tbody> </table>	Pin	Name														
Pin	Name																	

		7	TAuto
		6:5	TGated
		4	TAutoRestart
		3:0	TPrescaler_Hi
0x13	RxModeReg	Receive rate.	
0x14	TxControlReg	Controls antenna driver pins.	
		<b>Pin</b>	<b>Name</b>
		7	InvTx2RFOn
		6	InvTx1RFOn
		5	InvTx2RFOff
		4	InvTx1RFOff
		3	TX2CW
		2	N/A
		1	TX2RFEn
		0	TX1RFEn
0x15	TxASKReg	Transmit modulation setting. Bit 6 1 Forces a 100% ASK modulation	
0x16	TxSelReg	Analog module control.	
0x17	RxSelReg	Receiver settings.	
0x18	RxThresholdReg	Thresholds for receiving.	
0x19	DemodReg	Demodulator settings.	
0x1a	Reserved	Reserved for future use.	
0x1b	Reserved	Reserved for future use.	
0x1c	MfTxReg	MIFARE transmit parameters.	
0x1d	MfRxReg	MIFARE reception parameters.	
0x1e	Reserved	Reserved for future use.	
0x1f	SerialSpeedReg	UART serial speed.	
0x20	Reserved	Reserved for future use.	
0x21	CRCResultReg	CRC calculation.	
0x22	CRCResultReg	CRC calculation.	
0x23	Reserved	Reserved for future use.	
0x24	ModWidthReg	Modulation width.	
0x25	Reserved	Reserved for future use.	
0x26	RFCfgReg	Receiver gain.	
0x27	GsNReg	Conductance of antenna pins.	
0x28	CWGsPReg	Detailed	

0x29	ModGsPReg	Detailed.
0x2a	TModeReg	Timer settings.
0x2b	TPrescalerReg	
0x2c	TReloadRegH	
0x2d	TReloadRegL	
0x2e	TCounterValReg	
0x2f	TCounterValReg	
0x30	Reserved	
0x31	TestSel1Reg	Test signal configuration.
0x32	TestSel2Reg	Test signal configuration.
0x33	TestPinEnReg	
0x34	TestPinValueReg	
0x35	TestBusReg	
0x36	AutotestReg	
0x37	VersionReg	MFRC522 software version.
0x38	AnalogTestReg	
0x39	TestDAC1Reg	
0x3a	TestDAC2Reg	
0x3b	TestADCReg	

Be careful when using registers, they are encoded as follows:

7	6	5	4	3	2	1	0
1 = read 0 = write	address						0

As you can see, an address contains whether we are reading or writing to it ... it is also shifted one bit to the left.

To say that there is a lot of work in building access to RFID by hand is an understatement. However, by looking closely at the work already performed by others in various open source projects, we can get a feel for the steps of an implementation:

### Initialization

Reset

TModeReg ← 0x8d - TAuto=1, non-gated, TPrescalerHi=b1101

TPrescalerReg ← 0x3e - Low 8 bits of TPrescaler

TReloadRegL ← 30

TReloadRegH ← 0

TxASKReg ← 0x40 - Force 100% ASK

ModeReg ← 0x3d - Not MSBFirst, TxWaitRF, MFin active High, CRCPreset=0x6363

AntennaOn



## AntennaOn

```
If TxControlReg→Tx1RFEn is off or TxControlReg→Tx2RFEn is off
TxControlReg→Tx1RFEn = 1
TxControlReg→Tx2RFEn = 1
```

## Cameras

It is tantalizing to think about processing real-time images in an ESP32 and to begin down that journey, we need to be able to source video input.

See also:

- [Github: igrr/esp32-cam-demo](#)
- [Github: H-LK/ESP32\\_Aducam\\_Port](#)
- [Github: krzych/esp32-cam-demo](#)

## Ivan's sample

Ivan over at Espressif has produced a great sample application that utilizes the camera. The camera supported is the OV7725. It exposes the following functions:

- `uint8_t *camera_get_fb()` - Get the data of the frame buffer.
- `int camera_get_fb_height()` - Get the height of the frame buffer.
- `int camera_get_fb_width()` - Get the width of the frame buffer.
- `esp_err_t camera_init(camera_config_t config)` – Configure the camera interface. This is a structure which contains:
  - `pin_reset`
  - `pin_xclk`
  - `pin_sscb_sda`
  - `pin_sscb_scl`
  - `pin_d7`
  - `pin_d6`
  - `pin_d5`
  - `pin_d4`
  - `pin_d3`
  - `pin_d2`

- pin\_d1
- pin\_d0
- pin\_vsync
- pin\_href
- pin\_pclk
- int xclk\_freq\_hz
- ledc\_timer\_t ledc\_timer
- ledc\_channel\_t ledc\_channel
- camera\_pixelformat\_t pixel\_format
  - CAMERA\_PF\_RGB565
  - CAMERA\_PF\_YUV422
  - CAMERA\_PF\_GRAYSCALE
  - CAMERA\_PF\_JPEG
- camera\_framesize\_t frame\_size
  - CAMERA\_FS\_QQVGA
  - CAMERA\_FS\_QVGA
  - CAMERA\_FS\_VGA
  - CAMERA\_FS\_SVGA
- int jpeg\_quality
- camera\_print\_fb()
- camera\_probe(const camera\_config\_t \*config, camera\_model\_t \*out\_camera\_model)
- esp\_err\_t camera\_run() - Ask the camera to grab an image and then wait until it is ready.

In this sample, we get a buffer which is width x height bytes in size and is composed of 8 bit grayscale values. We can save the image data but how can we look at it?

I have had good success using the Linux ImageMagick tools. Specifically, if I save an image to the file "img.gray" and we know that the image is 320 x 240 pixels, we can convert this to a PNG using:

```
$ convert -size 320x240 -depth 8 img.gray img.png
```

See also:

- [Github: igrr/esp32-cam-demo](#)
- [ImageMagick](#)
- [OV7725](#)

## OV7670

The OV7670 camera is a very cheap camera device. It is powered at 3V and hence is perfect for use with the ESP32. The resolution is 640x480 pixels.

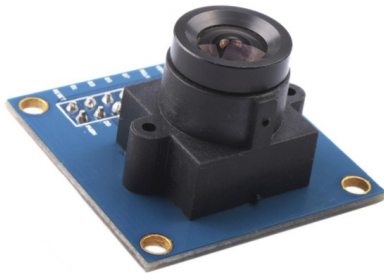

There are outputs of three synchronization signals. These are called VSYNC, HSYNC, and HREF.

See also:

- [OV7670 – Datasheet](#)
- [OV7670 – Implementation Guide – 2005-09-02](#)
- [OV7670 Software Application Note](#)

## Accelerometer and Gyroscope - MPU-6050 (aka GY-521)

The MPU-6050 is a 3.3V device.

An accelerometer measures the force of linear acceleration. Simply put, that when an object is at rest (i.e. sitting peacefully on your desk), it is not being accelerated (well ... it actually is but we'll come back to that later). When you start to move the object, it undergoes acceleration. Note that this is not the same as speed. Acceleration is the rate of change in speed over time. When you are sitting as a passenger in your car and the car is moving at a constant speed and if the ride were very smooth and you closed your eyes, you wouldn't know you were moving. However, if the gas or brake are pressed, your car would *change* speed and you would feel acceleration while the speed changed. You would feel yourself pushed back in your seat when the gas is pressed and you would feel yourself wanting to move forward if the brake is pressed. Similarly, if you stand in an elevator and press a button, you feel yourself being pushed into the floor when it starts to rise and you would find yourself wanting to rise when it comes to a stop. Acceleration is a vector quantity meaning that it has a directional quality

associated with it. In your car (assuming you are driving forward and we call the forward direction  $x$ ) then stepping on the gas produces an acceleration in the  $x$  direction while stepping on the brake produces an acceleration in the  $-x$  direction. Similarly with the elevator, when you rise there will be an acceleration in the  $z$  direction and when you stop, there will be an acceleration in the  $-z$  direction. There is one more twist to the story ... gravity. Although you may not have thought about it, as you sit in your chair there is a force acting on you that wishes to accelerate you. That force is called gravity and the direction of the acceleration is  $-z$ . If it weren't for the chair, your body would be accelerated towards the floor. Even though your body isn't moving, we can consider this an acceleration force being applied. What this means for us is that when a device such as the MPU-6050 is sitting on your desk, it will be reporting that it is accelerating downwards.

The practical implication of this is very interesting. If the MPU-6050 is flat on the desk, it will report an acceleration in its  $-z$  direction. If we now were to tilt the device, the acceleration due to gravity is still present but now the direction of that force will have changed. The magnitude of the acceleration will remain the same but the measurements will now show it spread over the  $x$ ,  $y$  and  $z$  axes. Working backwards, by examining the values of the acceleration on the  $x$ ,  $y$  and  $z$  axes, we can calculate the orientation of the device relative to the direction of gravity (i.e. relative to up and down).

Having just discussed the concept of measurement of acceleration through the notion of an accelerometer, we can now look at how a gyroscope comes into play. A gyroscope measures the change in velocity (if at all) of a device rotating around its own axis. A gyroscope measures changes in angular velocity.

The MPU-6050 combines these to measure both linear acceleration and angular velocity. The device measures both qualities in the  $x$ ,  $y$  and  $z$  axis and hence is considered a measurement in 6 degrees of freedom (linear acceleration in  $x$ ,  $y$  and  $z$  and angular velocity in  $x$ ,  $y$  and  $z$ ). The measurement values have a 16 bit resolution.

If our goal is to measure the orientation of the device, we may be able to see that the orientation can be found by examining the accelerometer values however these values only result in accurate answers if the device is at rest. If it is moved, then the acceleration due to movement can produce jittery results. If we look at the gyroscope, if we start from a known orientation (eg. flat on the desk), then in principle we should also be able to determine the device's current orientation by adding together all the gyroscopic changes that have happened to it since its original known (calibrated) position. Unfortunately, both of these techniques introduce errors. Using the accelerometer, we can determine our orientation by averaging values over time to remove jitter. As such, it gives good values over time but poor for short term

measurement. The gyroscope gives us good angular momentum values in the short term but the errors accumulate over time when we try and calculate the orientation of the device from its base state by successive addition of delta values. Fortunately, we can combine these two techniques through a variety of algorithms to give us a good value that is built from the combination of the two measurements.

The MPU-6050 device connects via an I2C bus (default address is  $0x68$  but can be changed to  $0x69$ ). This is 3.3V device and hence is safe to connect to ESP32 pins directly.

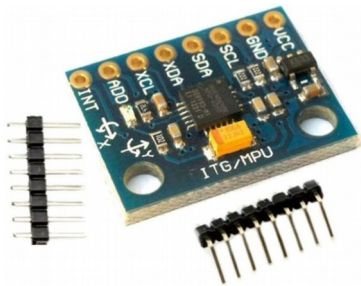

The device has the following pins exposed from the breakout boards:

Pin	Description
VCC	3.3V
GND	Ground
SCL	I2C Clock
SDA	I2C Data
XDA	Auxiliary I2C Data
XCL	Auxiliary I2C Clock
ADD	I2C address selection, either $0x68$ or $0x69$ . Low = $0x68$ , high = $0x69$ . It is not recommend to let this line float. Tie it to the desired signal.
INT	

A sample wiring of the device to ESP32 looks as follows:

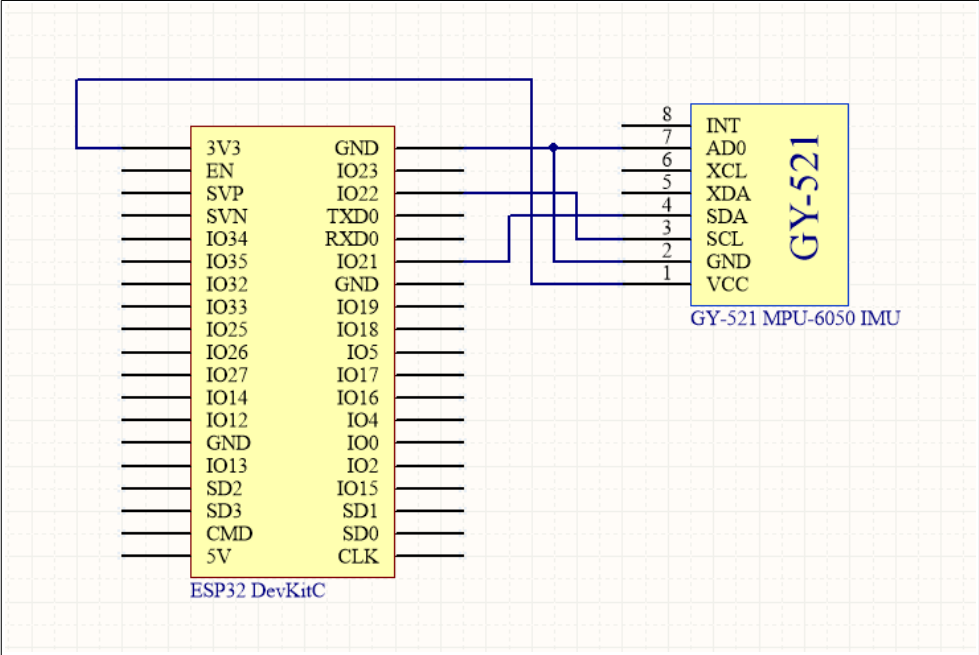

After wiring, if we run an I2C scanner we will see the device:

```

0 1 2 3 4 5 6 7 8 9 a b c d e f
00:  --  --  --  --  --  --  --  --  --  --  --  --  --  --  --  --
10:  --  --  --  --  --  --  --  --  --  --  --  --  --  --  --  --
20:  --  --  --  --  --  --  --  --  --  --  --  --  --  --  --  --
30:  --  --  --  --  --  --  --  --  --  --  --  --  --  --  --  --
40:  --  --  --  --  --  --  --  --  --  --  --  --  --  --  --  --
50:  --  --  --  --  --  --  --  --  --  --  --  --  --  --  --  --
60:  --  --  --  --  --  --  --  --  68  --  --  --  --  --  --  --
70:  --  --  --  --  --  --  --  --  --  --  --  --  --  --  --  --

```

Register	Offset	Name	Description
0x3B	0	ACCEL_XOUT_H	AccelX High
0x3C	1	ACCEL_XOUT_L	AccelX Low
0x3D	2	ACCEL_YOUT_H	AccelY High
0x3E	3	ACCEL_YOUT_L	AccelY Low
0x3F	4	ACCEL_ZOUT_H	AccelZ High
0x40	5	ACCEL_ZOUT_L	AccelZ Low
0x41	6	TEMP_OUT_H	Temp High
0x42	7	TEMP_OUT_L	Temp Low
0x43	8	GYRO_XOUT_H	GyroX High
0x44	9	GYRO_XOUT_L	GyroX Low
0x45	10	GYRO_YOUT_H	GyroY High
0x46	11	GYRO_YOUT_L	GyroY Low
0x47	12	GYRO_ZOUT_H	GyroZ High
0x48	13	GYRO_ZOUT_L	GyroZ Low

Note that the data values are signed 16 bits in big endian format.

To use the I2C protocol, we send the value 0 to register PWR\_MGMT\_1 (0x6b).

Flag	Description
Device Reset [7]	Reset the device
Sleep [6]	Put the device to sleep
Cycle [5]	Cycle between awake and asleep
Temp disable [3]	Disable the temperature sensor
Clksel [2:0]	Clock source of the devuce

You will sometimes see these devices referred to as Inertial Measurement Units (IMUs).

The value returned from the accelerometer is a raw value. The actual result we want is measured in gravities (g) which is about  $9.81 \text{ ms}^{-2}$ . The device has various sensitivities built in. To get to the real value, we need to divide by a scaling factor as show below:

Acceleration Limit	Sensitivity Factor
2g	16384
4g	8192
8g	4096
16g	2048

Thus to get the required value from the raw value we would use the equation:

$$\text{required value} = \frac{\text{raw value}}{\text{sensitivity factor}}$$

By default, the device is configured for a 2g acceleration limit

Similarly, there is an angular velocity scaling:

Angular Velocity Limit	Sensitivity Factor
250°/s	131
500°/s	65.5
1000°/s	32.8
2000°/s	16.4

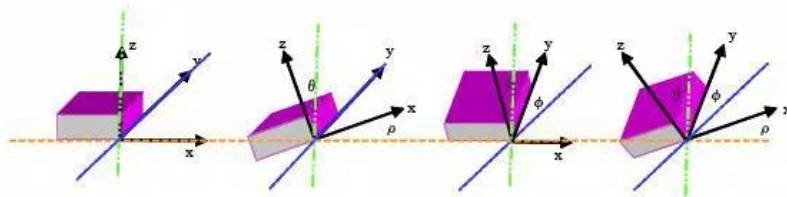

Figure 8. Three Axis for Measuring Tilt

$$\rho = \arctan\left(\frac{A_X}{\sqrt{A_Y^2 + A_Z^2}}\right)$$

$$\phi = \arctan\left(\frac{A_Y}{\sqrt{A_X^2 + A_Z^2}}\right)$$

$$\theta = \arctan\left(\frac{\sqrt{A_X^2 + A_Y^2}}{A_Z}\right)$$



Technical task ... send in accel values X, Y and Z.

See also:

- [Accelerometers](#)
- [YouTube – ESP32 Technical Tutorials: MPU6050 Accelerometer](#)
- [Tilt Sensing Using a Three-Axis Accelerometer](#)
- [MPU-6050 Data Sheet](#)
- [MPU6050 Register Map and Descriptions](#)
- [MPU-6050 Accelerometer + Gyro](#)
- [I2Cdevlib – MPU-6050](#)
- [Filters](#)
- [InvenSense – MPU-6050 Home Page](#)
- [Gyroscopes and Accelerometers on a Chip](#)
- [Using an accelerometer for inclination sensing](#)
- YouTube: [MPU-6050 Data with a Complementary Filter](#)
- [Digi-Key: How the latest MEMS inertial modules help overcome application development challenges](#)

### The math of accelerometers

Our real world is composed of three spatial dimensions. In English we might think of these as left/right, up/down and in/out (or forward/back). In our math, we will label these by the common x, y and z. If we want to think about the orientation of something, we can think of it as the rotation about these axis. We define the rotation around the x axis as "roll" designated by the symbol " $\Phi$ ". We define the rotation around the y axis as "pitch" designated by the symbol " $\Theta$ " and finally, we define the rotation around the z axis as "yaw" designated by the symbol " $\Psi$ ". So, to think about the orientation of an object, we can think about its roll, pitch and yaw.

Axis	Name	Symbol
x	roll	$\Phi$
y	pitch	$\Theta$
z	yaw	$\Psi$

Now, let us merge in the notion of how we are going to measure our roll, pitch and yaw. Assuming no acceleration of our device (I.e it is stationary) then there will be a constant force on it of 1g in the z axis. So the force measured in the z axis will be 1 and x and y will both be 0. As we tilt the device from its horizontal orientation, that force will start to be distributed across multiple axis and not just the z axis. So a tilt will produce a new measured force value in both x and y. And here comes the magic. The measured force change is proportional to the roll and pitch angles. But wait, what about the yaw? Well ... if we think about it, a rotation around the z axis does not change the tilt of what we

want to measure. Think of it like this, if we have a perfectly flat table top and place some marbles on its surface, if we tilt the table left or right, the marbles will roll. If we tilt it forward or back, the marbles will roll. However, if we are gentle and rotate the table around its central vertical axis, the marbles will not roll. They will remain in their same position relative to the table.

Another way to think about this is to hold your cell phone in your hand flat while sitting on a chair. If you now spin around on your chair, have you changed the "tilt" of your cell phone? I would say no.

What this means to us is that we can calculate the orientation of our device only by figuring out the roll and pitch. The yaw becomes immaterial to our story (for just now).

By some math, we can find that:

$$\tan(\Phi) = \frac{G_{py}}{G_{pz}}$$

$$\tan(\Theta) = \frac{-G_{px}}{\sqrt{G_{py}^2 + G_{pz}^2}}$$

See also:

- [Using an Accelerometer for Inclination Sensing](#)
- [Understanding Euler Angles](#)

### Visualizing orientation

It is all very good getting raw numbers representing the amount and direction of force on our device against different axis, but triplets of numbers isn't at all intuitive to our ways of thinking. Instead, what we want is a mechanism to "see" the orientation of the device. Since orientation is inherently a three dimensional physical consideration, what we want is to visualize the data as a 3D scene. There are many 3D programming packages on the Internet with varying degrees of sophistication and capabilities. Since my belief is that all user interfaces should be browser based as opposed to thick client, I wanted one that could run in a browser. I also wanted one that is open source. For this I chose "three.js".

See also:

- [three.js](#)

### Compass - HMC5883L (aka GY-271) (aka CJ-M49)

In the real world, a compass is a device which can be used to determine the direction of magnetic north. There are also electronic components that can perform the same task.

One such component is the HMC5883L (which has been superseded by the HMC5983 but both are compatible with each other). Strictly speaking, the device measures the intensity of any magnetic field around it. Since field strength is a vector quantity (has both magnitude and direction), we will be measuring the field strength in the X, Y and Z axis. The going price for one of these on eBay is about \$3.

The calculation of a compass bearing is affected by the relative tilt of the device. What this means is that if the device is tilted the compass bearing result will be wrong. We can compensate for this if we know the amount of tilt. This can be calculated from an MPU-6050.

This is a 3.3V device.

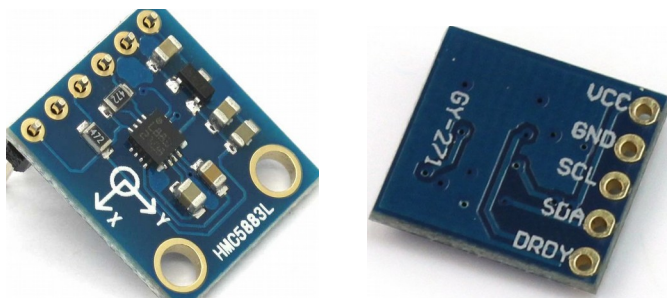

The pin configuration for GY271 is (Left-Right as seen from chip side with connector at top):

Pin	Function
DRDY	Data ready/Interrupt
SDA	I2C Data line
SCL	I2C Clock line
GND	Ground
VCC	+ve voltage – 3.3V

The pin configuration for the CJ-M49 is (Left-Right as seen from chip side with connector at top):

Pin	Function
3V3	+ve voltage – 3.3V
DRDY	Data ready/Interrupt
SDA	I2C Data line
SCL	I2C Clock line
GND	Ground
VCC +5V	+ve voltage – 5V

The module makes its data available via the I2C bus. The I2C address of the device is 0x1E. If we run an I2CScanner we will see the device as being present:

```

    0  1  2  3  4  5  6  7  8  9  a  b  c  d  e  f
00:  --  --  --  --  --  --  --  --  --  --  --  --  --  --  --
10:  --  --  --  --  --  --  --  --  --  --  --  --  --  1e  --
20:  --  --  --  --  --  --  --  --  --  --  --  --  --  --  --
30:  --  --  --  --  --  --  --  --  --  --  --  --  --  --  --
40:  --  --  --  --  --  --  --  --  --  --  --  --  --  --  --
50:  --  --  --  --  --  --  --  --  --  --  --  --  --  --  --
60:  --  --  --  --  --  --  --  --  --  --  --  --  --  --  --
70:  --  --  --  --  --  --  --  --  --  --  --  --  --  --  --

```

From I2C there are a set of registers that can be accessed:

Address	Description	Access
00	Configuration register A	Read / Write
01	Configuration register B	Read / Write
02	Mode register	Read / Write
03	Data output X MSB register	Read
04	Data output X LSB register	Read
05	Data Output Z MSB register	Read
06	Data Output Z LSB register	Read
07	Data output Y MSB register	Read
08	Data output Y LSB register	Read
09	Status register	Read
10	Identification register A	Read
11	Identification register B	Read
12	Identification register C	Read

Think of the device as having a register cursor. We can move the cursor simply by sending the id of the register to move to. For example, sending the device `0x03` will move the cursor to register `3`. Subsequent reads will read from the cursor location **and** auto-increment the cursor. So moving to register `3` and reading `6` bytes will read the next `6` register values [`0x03-0x08`].

Configuration Register A (register `00`) is as follows:

Name	Bits	Description
	7	Reserved. Must be 0.
MA	6:5	Averaged samples per measurement: <ul style="list-style-type: none"> <li>● 00 = 1 (default)</li> <li>● 01 = 2</li> <li>● 10 = 4</li> <li>● 11 = 8</li> </ul>
DO	4:2	Data output rate in measurements/second: <ul style="list-style-type: none"> <li>● 000 = 0.75</li> <li>● 001 = 1.5</li> <li>● 010 = 3</li> <li>● 011 = 7.5</li> <li>● 100 = 15 (default)</li> <li>● 101 = 30</li> <li>● 110 = 75</li> <li>● 111 = Reserved</li> </ul>
MS	1:0	Measurement configuration <ul style="list-style-type: none"> <li>● 00 – Normal (default)</li> <li>● 01 – Positive bias</li> <li>● 10 – Negative bias</li> <li>● 11 – Reserved</li> </ul>

Configuration Register B (register `01`) is as follows:

Name	Bits	Description
GN	7:5	Gain values: <ul style="list-style-type: none"> <li>• 000 = 1370</li> <li>• 001 = 1090 (default)</li> <li>• 010 = 820</li> <li>• 011 = 660</li> <li>• 100 = 440</li> <li>• 101 = 390</li> <li>• 110 = 330</li> <li>• 111 = 230</li> </ul>
	4:0	Reserved. Must be 0.

### Mode Register (02)

Name	Bits	Description
HS	7	High speed I2C control
	6:2	Reserved. Must be 0.
MD	1:0	Operating mode: <ul style="list-style-type: none"> <li>• 00 = Continuous</li> <li>• 01 = Single measurement (Default)</li> <li>• 10 = Idle mode</li> <li>• 11 = Idle mode</li> </ul>

The three identification registers return the ASCII values 'H' (0x48), '4' (0x34) and 'C' or 'H' (0x48), '4' (0x34) and '3' (0x33)

To create an angle in degrees, the following formula can be used:

```
angle = atan2((double)y, (double)x) * (180 / 3.14159265) + 180; // angle in degrees
```

The driving logic at a high level is:

Function	Description
Write 0x02	Select mode register
Write 0x00	Continuous measurement mode
Write 0x03	Select register 3
Read 6 bytes	X, Z, Y value pairs MSB/LSB

we combine MSB and LSB of data with:

```
data[0] << 8 | data[1];
```

Attachment of the device to ESP32 is particularly easy. As you can see it only needs 4 wires to connect.

Here is a schematic of how an instance of the board may be wired to ESP32.

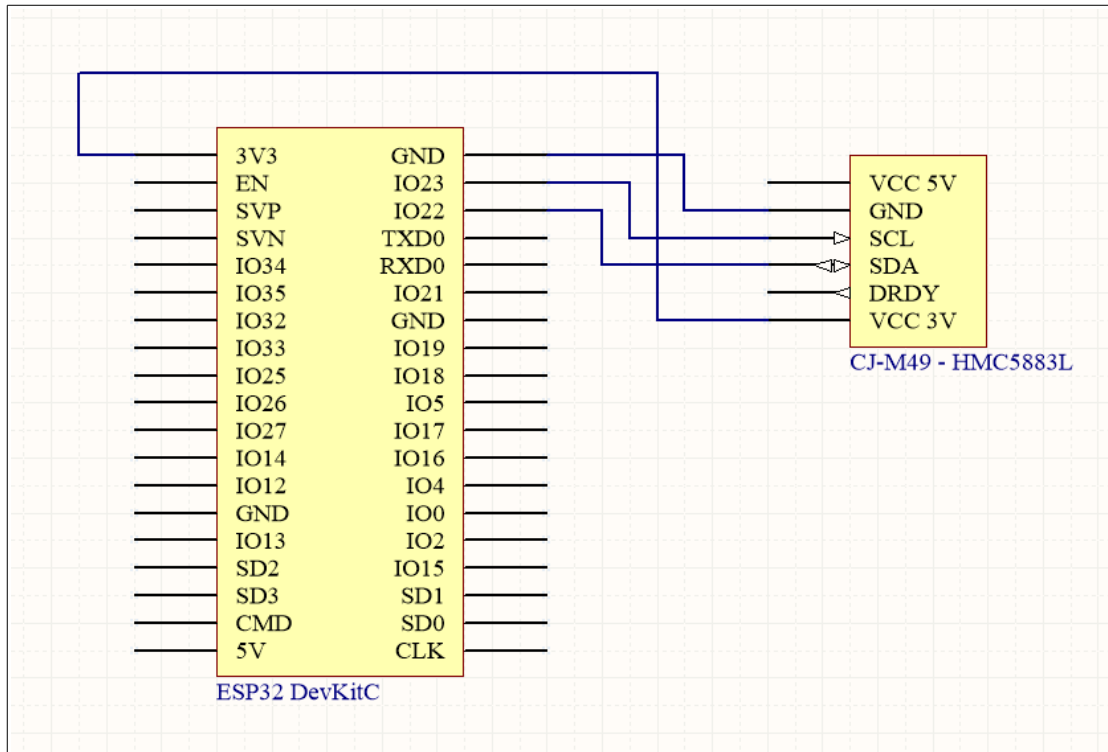

When we use a compass, the result we usually want is "which way is North". On a real physical compass, we have a needle that points in that direction and we know our answer. Through a digital device, what we should expect to get back is an angle that the device would have to be oriented for it to point North. This assumes that there is a reference mark on the device from which the angle has meaning.

When experimenting with the device, don't bring strong magnets too close to the device as it may become magnetized or otherwise damaged.

See also:

- [Data sheet](#)
- [Sparkfun Tutorial](#)
- [Arduino Nano + GY-271 \(Digital Compass module\) + OLED](#)
- [Electrodragon - HMC5883L - Three-Axis Compass](#)
- [YouTube – ESP32 Technical Tutorials: HMC5883L – Compass](#)
- [YouTube – Arduino How To: HMC5883L Compass Magnetometer Tutorial](#)
- [YouTube – Use the HMC5883L 3-axis sensor with an Arduino – Tutorial](#)

- YouTube – [Let's build an Arduino electronic Compass using the HMC5883L and a Ring of LEDs - Tutorial](#)
- Wikipedia – [atan2](#)
- Github – [Arduino Library](#)

### Tilt compensation of the compass

When the compass module is perfectly planar, it returns a good value but if it is tilted, then the value is no longer true. Look at the following diagram and imagine your compass center in a perfect horizontal plane. At that time, there will be no roll and no pitch. For our purposes, the yaw of the board will be pointing vertically straight up and we don't care. The value of the compass will be correct. However if the board is tilted with roll and pitch, then the compass value is no longer accurate. However, given the value measured from the compass and if we have the values of roll and pitch, we can compensate and calculate a correct compass value.

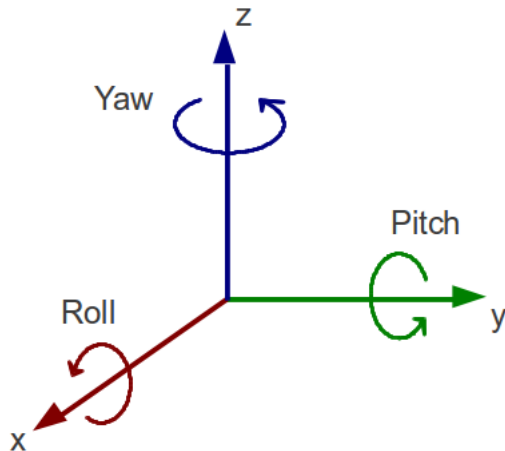

Again by looking at the above image, consider an accelerometer. This will measure the force of gravity and gives us a reference to the orientation of the compass sensor. When the sensor is horizontal, the acceleration measured will be exclusively down the Z axis however when the sensor is tilted, the acceleration will be distributed across X, Y and Z and by using math, we can determine the orientation of the board. As a side note, when the board is horizontal, the compass bearing will be the yaw value.

We will define the following definitions:

$\Phi$ – phi	Roll (X)
$\Theta$ – theta	Pitch (Y)
$\Psi$ – psi	Yaw (Z)



See also:

- [Implementing a Tilt-Compensated eCompass using Accelerometer and Magnetometer Sensors](#)
- Wikipedia: [Axes conventions](#)

## Real time clocks

When we start an ESP32, it doesn't know what the real time is. We can tell it once booted but even then, once we power it off, it will forget again. If the ESP32 is connected to the Internet, it can learn the real time by using a network time protocol. However, if our ESP32 is not connected to the Internet and is network isolated, by default, it has no mechanism to know the current time. This is what we can add a real-time-clock (RTC) module. A real-time clock module is a small piece of electronics that contains a battery and is taught the current date and time. Because it has an on-board battery, it can remember the time even when the ESP32 is powered off. When the ESP32 boots, it can be configured to ask the RTC module for the current date/time and use that from then on.

There are many RTC modules available but one of the more prevalent is the DS1307.

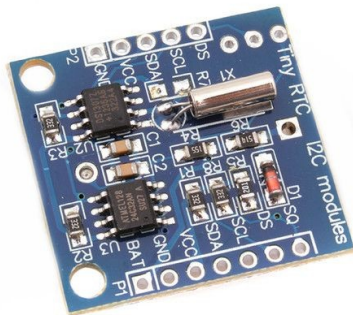

These can be picked up on eBay for about \$1. The RTC uses battery backup when not powered. This is a standard CR2032 type. When inserting the battery, it is +ve down. When soldering on header pins, think through how you will mount the board when complete. It may be that you want to solder the header pins such that you can easily access and replace the battery once attached to your PCB or strip board.

This device provides a real time clock capability that includes hours, minutes, seconds, month, day of month, day of week and year. Month calculations including leap year support are also accommodated. Interestingly, it also provides 56 bytes of non-volatile RAM. The device uses I2C for communication.

Note: Before plugging your board to the ESP32, realize that this is a 5V module. If you connect 5V to the ESP32 GPIO pins bad things can happen because they are 3.3V pins. The I2C protocol uses pull-up resistors to bring the SDA and SCL lines high by default. If we were to look at the schematic diagram of this module we would find that resistors R2 and R3 are pull-up resistors. Unfortunately, we have two problems. First is that the ESP32 already pulls up the pins and secondly the module pulls them high to a 5V line which is too much for the ESP32. The solution is to physically remove these two resistors from your module before use. The resistors are clearly marked on the board as R2 and R3 and carry the mark 332 (3.3k).

Since the device has battery backup, an interesting question is how long can this module keep time for? If we examine the data sheet, we find that it consumes 500nA while running on battery. If we understand that a typical CR2032 battery has a capacity of 200mAh then, if my math is correct, this works out to be about 45 years ... which is well past the life of the battery itself.

The boards have 5 pins on one side 7 on the other.

Pin	Label	Description
1	DS	DS18B20 Temp.
2	SCL	I2C clock.
3	SDA	I2C data line.
4	Vcc	Vcc (5V).
5	GND	Ground.

Pin	Label	Description
1	SQ	Square wave output.
2	DS	DS18B20 Temp.
3	SCL	I2C clock.
4	SDA	I2C data line.
5	VCC	Vcc (5V).
6	GND	Ground.
7	BAT	Battery voltage

Once plugged in, we will see the RTC at I2C address `0x68`:

```

    0  1  2  3  4  5  6  7  8  9  a  b  c  d  e  f
00:  --  --  --  --  --  --  --  --  --  --  --  --  --  --  --
10:  --  --  --  --  --  --  --  --  --  --  --  --  --  --  --
20:  --  --  --  --  --  --  --  --  --  --  --  --  --  --  --
30:  --  --  --  --  --  --  --  --  --  --  --  --  --  --  --
40:  --  --  --  --  --  --  --  --  --  --  --  --  --  --  --
50:  --  --  --  --  --  --  --  --  --  --  --  --  --  --  --

```

60: --- -- -- -- -- -- -- -- -- 68 --- -- -- -- -- -- -- -- --  
 70: --- -- -- -- -- -- -- -- --

The device has registers contained within it that are laid out as follows:

Address	Bit 7	Bit 6	Bit 5	Bit 4	Bit 3	Bit 2	Bit 1	Bit 0	Function	Range
0x00	CH	10 Seconds			Seconds				Seconds	00-59
0x01	0	10 Minutes			Minutes				Minutes	00-59
0x02	0	0 – 24	10 hour	10 Hour	Hours			Hours	1-12 AM/PM 00-23	
		1 – 12	AM/PM							
0x03	0	0	0	0	0	Day		Day	01-07	
0x04	0	0	10 Date		Date			Date	01-31	
0x05	0	0	0	10 Month	Month			Month	01-12	
0x06	10 Year				Year			Year	00-99	
0x07	OUT	0	0	SQWE	0	0	RS1	RS0	Control	
0x08 - 0x3f									RAM	0x00 - 0xFF

The encoding of the data is known as "Binary Coded Decimal" (BCD). Each decimal digit is encoded as a 4 bit representation. For example, the decimal number "34" would be encoded as 0011 1000. The first four bits representing "3" and the last four bits representing "4".

To convert a two digit decimal valued integer to a BCD representation we would use the expression:

```
bcdValue = ((num / 10) << 4) | (num%10)
```

to convert from a BCD to an integer, we would use the expression:

```
num = (bcdValue >> 4) * 10 + (bcdValue & 0x0f)
```

In addition to performing the service of a real time clock, this device also provides 56 bytes of battery backed up RAM. While 56 bytes doesn't sound like much, it could be used to hold fourteen 32 bit integer values or perhaps an SSID/password pair.

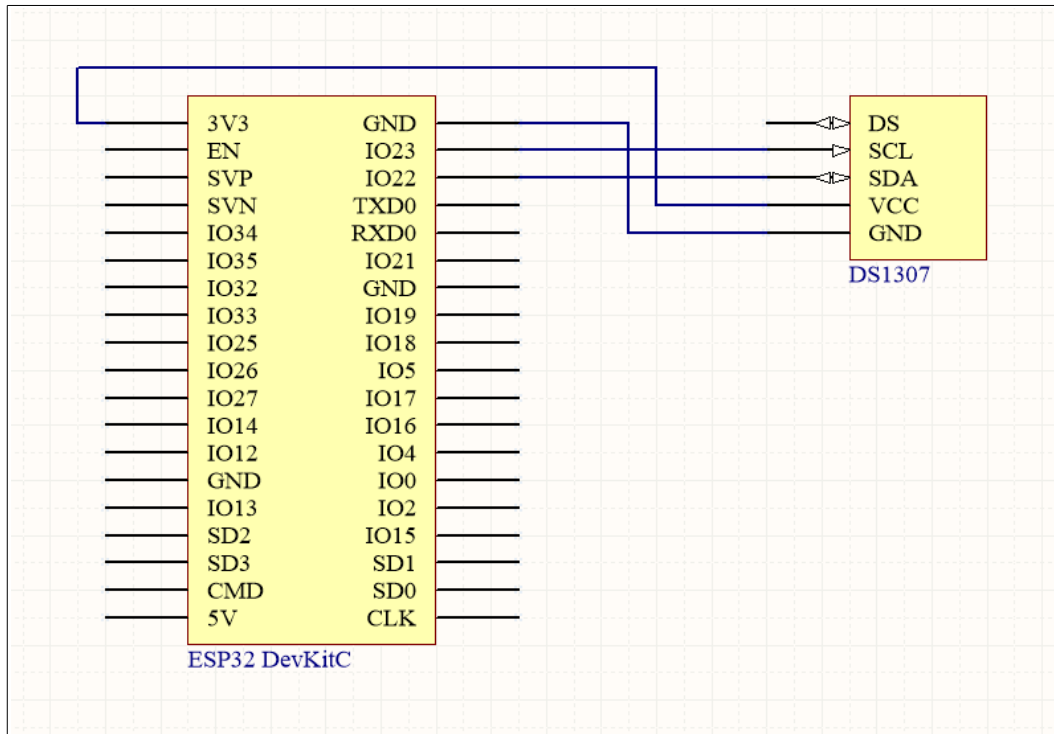

See also:

- [YouTube – ESP32 Technical Tutorials: DS1307 Real Time Clock](#)
- [Tutorial – Using DS1307 and DS3231 Real-time Clock Modules with Arduino](#)
- [Maxim integrated datasheet](#)

## Servos

A servo is a physical movement device similar to an electric motor. Typically, a servo has a rotation shaft that can rotate from 0 degrees to 180 degrees as a function of the incoming signal applied to it. If one sets the signal to a specific value, the shaft will rotate to a specific position as a function of that signal. The actual minimum and maximum angles are specified by the manufacturer of any particular servo model.

The signal expected by a servo is encoded as Pulse Width Modulation (PWM). One should always consult the manufacturers data sheet to find the specific values. However, in general, the story works as follows.

Typically, the period of the PWM is 20 milliseconds. If we think this through, we will realize that 20ms is 50Hz as there are 50 instances of 20ms periods in 1 seconds (1000ms). At the start of the period, the duration that the signal is high determines the rotation of the shaft. For example, it may be defined that there is a minimum value of 1 millisecond and a maximum value of 2 milliseconds. This means that if the signal is high for 1 millisecond, the shaft rotates to its minimum value. If the signal is high for 2

milliseconds, the shaft rotates to its maximum value. For high durations between 1 and 2 milliseconds, the shaft rotates proportionally to that duration.

Here is a diagram (not drawn to scale) to illustrate the principle:

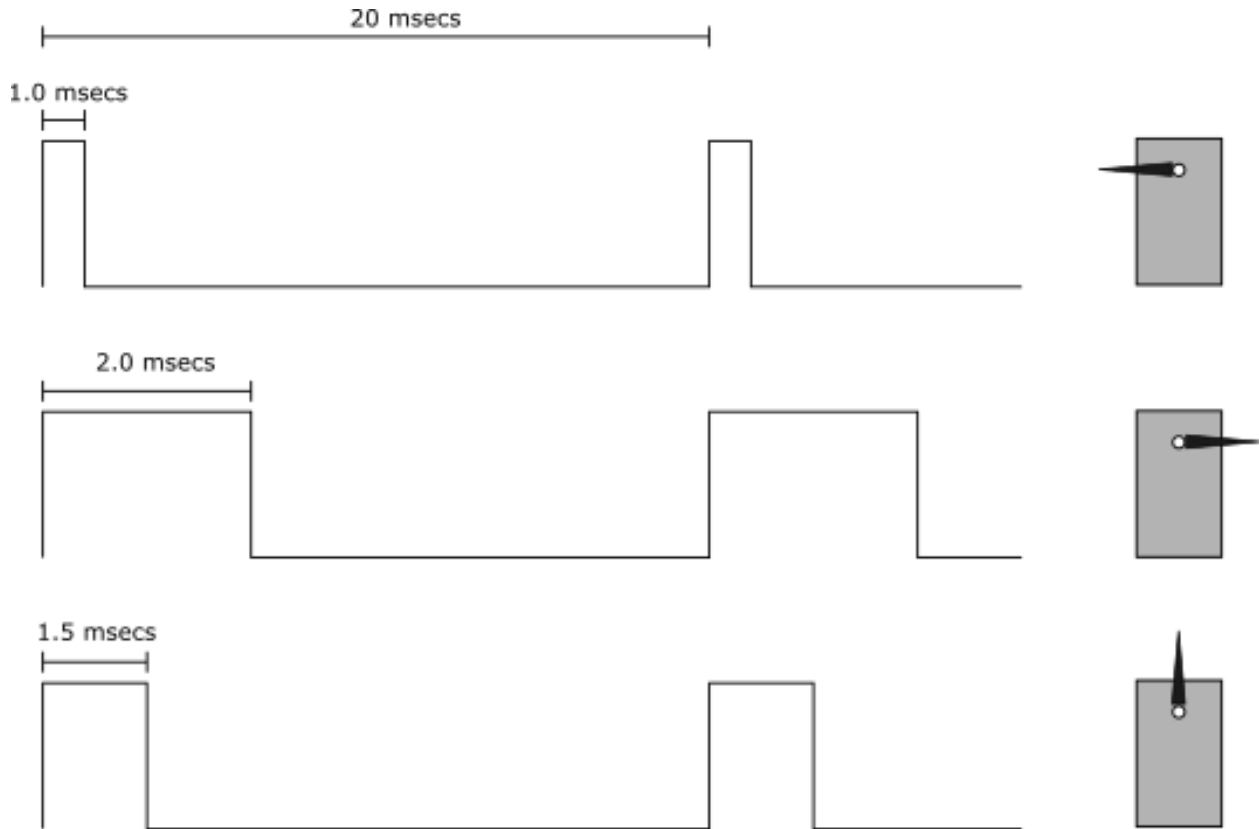

Again, it is important to read the data sheet to find the correct values for minimum and maximum duty cycle widths.

We also need to remember that the voltage output from a ESP32 GPIO pin is 3.3v. Most of the servos require a signal at the 5v level. This means that we can't directly drive a servo's data signal input from a ESP32 pin. We will need to employ a logic level shifter to shift the output PWM signal from 3.3V up to 5V.

If we use the ESP-IDF drivers and we imagine that the minimum duty cycle is 1ms and the max is 2ms with a period of 20ms, then we see that the range of duty cycle is 1ms which is 1/20th of the period. This then gives us the granularity of adjustment for the servos by looking at the different bit sizes available for the PWM timers:

Bit Size	Granularity (1ms spread)	Low (1ms)	High (2ms)
10	51	51.2	102.4
11	102	102.4	204.8
12	204	204.8	409.6
13	408	409.6	819.2
14	819	819.2	1638.4
15	1638	1638.4	3276.8

See also:

- LEDC – Pulse Width Modulation – PWM

### The Mini/Micro SG90

The mini/micro SG90 servos can be found on eBay for under \$2 each. These servos weight only 9g. They have a stall torque of 1.8kg·cm, operate at 5v, have a speed of about 0.3 seconds for 180° and have discrete step instances of 10μs. The stalled current draw on one of these servos is reported to be 600mA.

Color	Function
Red	Vcc
Brown	Ground
Orange	PWM

See also:

- Mini/Micro SG90 – [Data sheet](#)

## Audio

### PCM5102 - I2S DAC

This device takes as input an I2S signal and produces an analog audio output.

Pin	Function
VCC	
3.3V	
GND	
FLT	Filter select
DMP	De-emphasis
SCK	System clock input
BCK	Audio data bit clock input
DIN	Audio data in
LCK	Audio data word clock input
FMT	Audio format selection
XMT	Mute control

See also:

- I2S Bus
- [Data sheet](#)

## Graphic Equalizer

An integrated circuit called the MSGEQ7 is a graphic equalizer. It can operate at 3.3V or 5V.

If we provide it an audio input signal, it will analyze the signal into 7 discrete frequency bands of 63Hz, 160Hz, 400Hz, 1KHz, 2.5KHz, 6.25KHz and 16KHz.

The integrated circuit is supplied in an 8 pin configuration with:

Pin	Function	Description
1	VDDA	3.3-5V power supply
2	VSSA	Negative
3	OUT	Multiplexed DC Output. This is an analog output value.
4	STROBE	Channel selection
5	IN	Audio input
6	GND_REF	
7	RESET	Reset. A high resets the multiplexor, low enables the strobe.
8	CKIN	Clock. This is passive component clock circuit.

VDDA	CKIN
VSSA	RESET
OUT	GND_REF
STROBE	IN

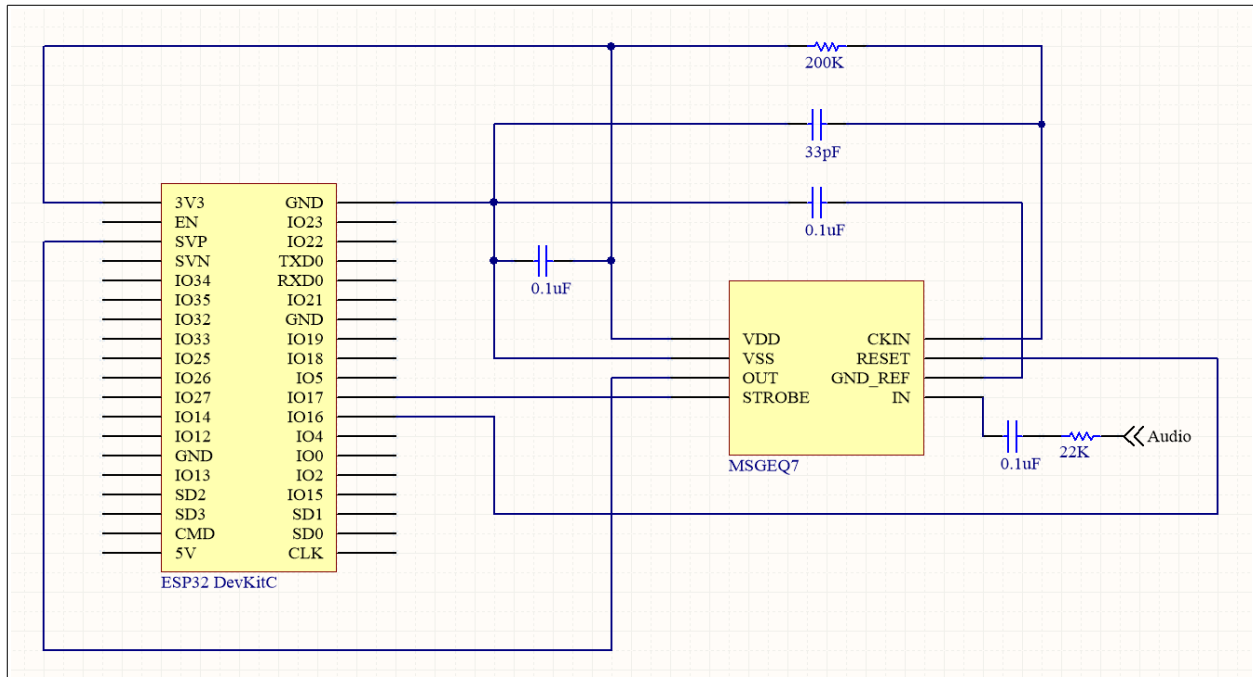

Yellow reset - 16

Blue Strobe - 17

Green Out

[3.3V] [GND] [OUT - GREEN – GPIO 36] [STROBE BLUE – GPIO 17] [ RESET – YELLOW - GPIO 16]

The high level of operation is that we apply our audio signal in "IN" pin. Normally, the RESET pin is low. When it goes high and then low again, the decoding of the signal is latched. Now we can read data from the "OUT" pin which is an analog value. The STROBE pin is initially high. When it goes low, we can read the value of OUT. When it goes high and then low again, we will have stepped onto the next frequency.

A high level algorithm would be:

```
pinMode(RESET, OUTPUT);
pinMode(STROBE, OUTPUT);
pinMode(OUT, ANALOG);

digitalWrite(RESET, LOW);
```



```

digitalWrite(STROBE, HIGH);

digitalWrite(RESET, HIGH);
delay(1);
digitalWrite(RESET, LOW);
delay(1);

digitalWrite(STROBE, LOW);
delay(1);
v63hz = analogRead(OUT);
digitalWrite(STROBE, HIGH);
delay(1);

digitalWrite(STROBE, LOW);
delay(1);
v160hz = analogRead(OUT);
digitalWrite(STROBE, HIGH);
delay(1);

digitalWrite(STROBE, LOW);
delay(1);
v400hz = analogRead(OUT);
digitalWrite(STROBE, HIGH);
delay(1);

digitalWrite(STROBE, LOW);
delay(1);
v1000hz = analogRead(OUT);
digitalWrite(STROBE, HIGH);
delay(1);

digitalWrite(STROBE, LOW);
delay(1);
v2500hz = analogRead(OUT);
digitalWrite(STROBE, HIGH);
delay(1);

digitalWrite(STROBE, LOW);
delay(1);
v6250hz = analogRead(OUT);
digitalWrite(STROBE, HIGH);
delay(1);

digitalWrite(STROBE, LOW);
delay(1);
v16000hz = analogRead(OUT);

```

For an easy wiring solution, breakout modules exist. These provide an MSGEQ7, pin outs, passive components and signal input sockets on a single board ready to be wired in.

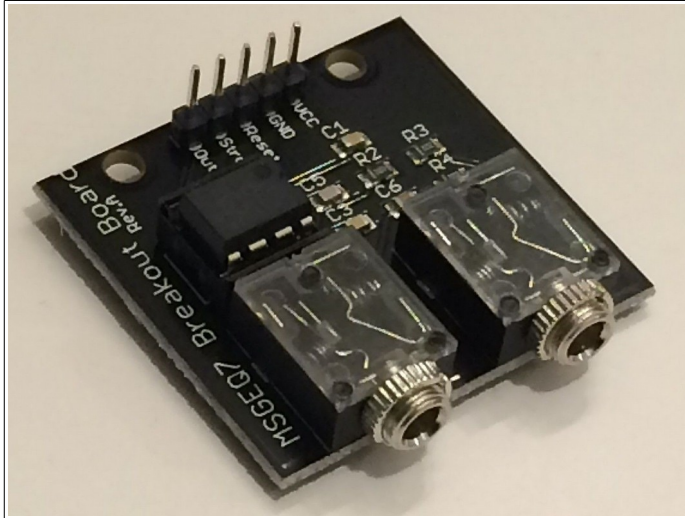

The pins exposed are:

- VCC – Power
- GND – Ground
- RESET – Reset pin (input)
- STROBE – Strobe Pin (input)
- OUT – Analog output

See also:

- [Datasheet](#)
- [MSGEQ7-Based DIY Audio Spectrum Analyzer: Construction](#)

## External networking

It may seem strange to include additional networking hardware interfacing given that the ESP32 is a first class WiFi and Bluetooth device however there are times when we want to performing networking which doesn't fit either of those categories. While WiFi and Bluetooth are great, you may have to interact remotely with devices which don't support those protocols. A classic example are the cheap nRF24 modules from Nordic. These devices are reported to easily be able to transmit and receive over 300 feet and hence become ideal components for longer distance communications.

### The nRF24

The nRF24L01 is an extremely cheap communication device. It allows one to transmit and receive data over large distances (hundreds of feet). It transmits and receives packets between similar devices. Do not confuse it with WiFi or Bluetooth. You can

transmit from one nRF24 to another nRF24 but not to anything else. There are a number of reasons to consider this device for projects over others. First is the very low cost. An instance of the device can be picked up for less than a dollar. Second is the peer-to-peer nature of the devices. There does not need to be a master/slave relationship in the story. In fact, two or more devices can exchange packets with each other without any of them acting as controllers. There are occasions where this is exactly what is needed.



The device operates on 3.3V and uses SPI as a protocol. The pin-out on the nRF24L01 is:

Pin	Description
Vcc	3.3V
GND	Ground
MISO	SPI Master In/Slave Out.
MOSI	SPI Master Out/Slave In.
SCK	SPI System clock.
CSN	SPI Chip Select – Enable the device (active low). Normally this will be wired to ground.
CE	RX or TX mode. The Data sheet calls this Chip Enable which seems an awfully strange name for a communication mode selector. CE=1 for transmit while CE=0 for receive.
IRQ	Maskable interrupt.

Seen from above, the pins are:

GND	VCC
CE	CSN
SCK	MOSI
MISO	IRQ

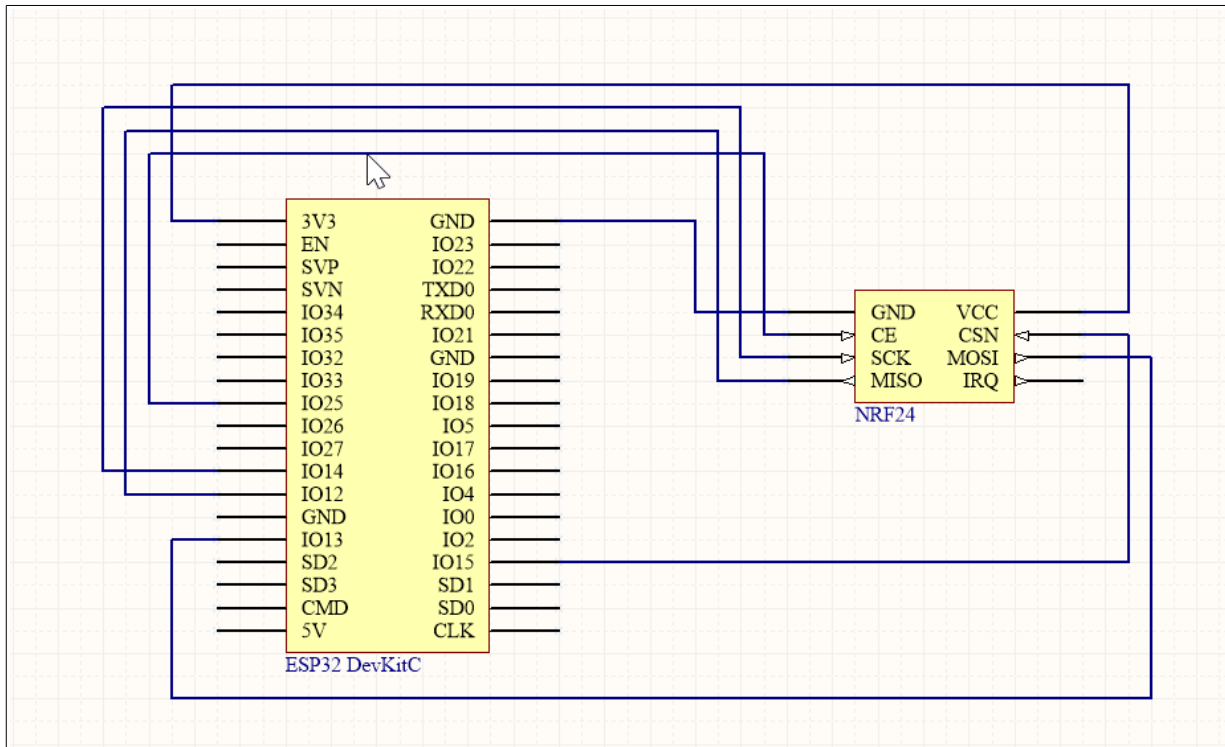

Some of the key specifications of this component include up to 2Mbps transmission rate and low power consumption. It operates in the 2.4GHz wireless band.

The device operates in a variety of different modes ... here is the state transition diagram for them which taken from the data sheet:

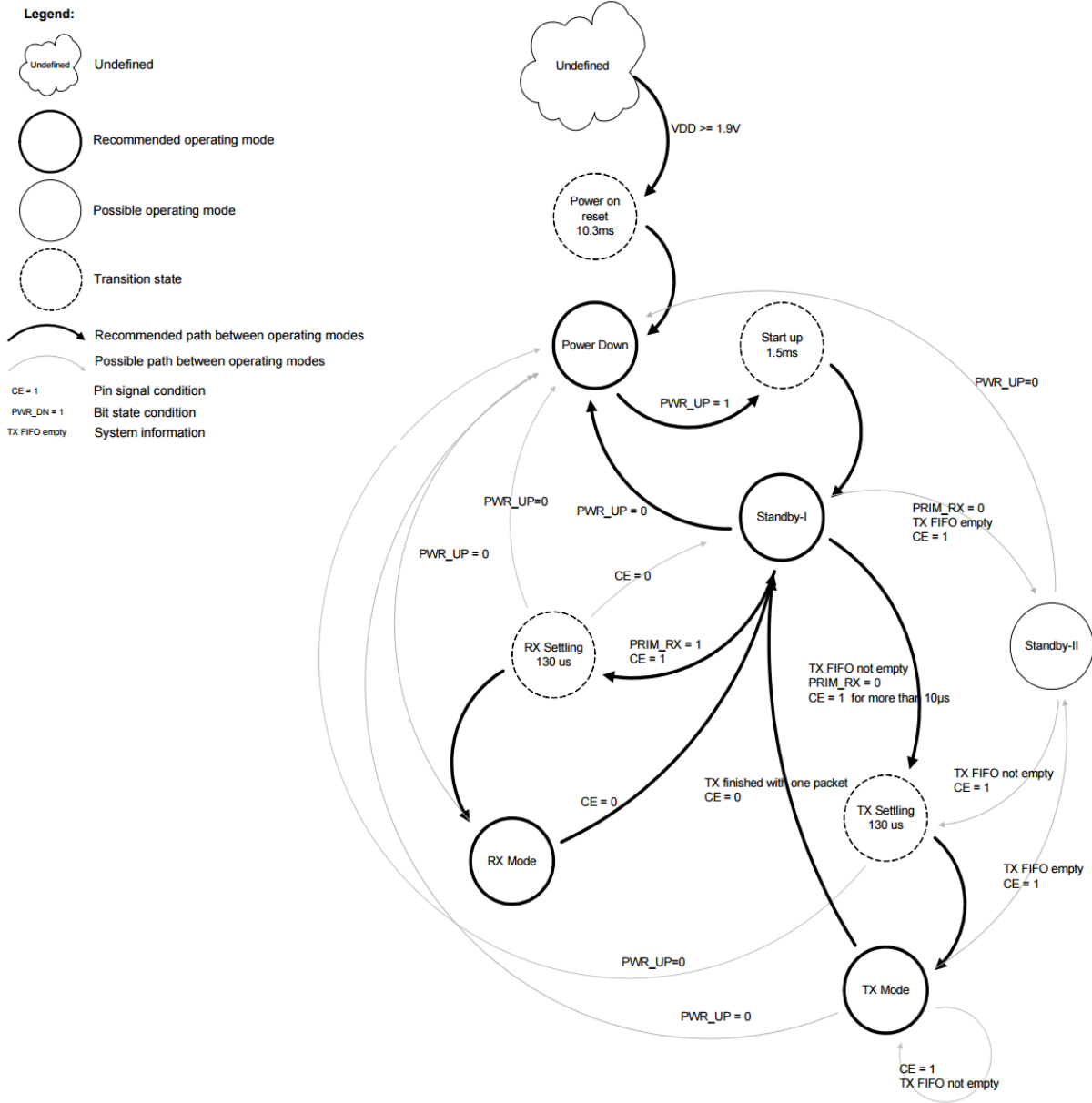

The first mode is "Power Down". This is the lowest power mode while still maintaining state/configuration.

The second mode is called "Standby". Again in this mode it is consuming low amounts of power but not as much as "Power Down". The difference between this mode and "Power Down" is how quickly it can begin transmitting and receiving.

The third mode is called "RX". In this state the device is a receiver.

The final mode is called "TX" and is entered when the device is transmitting data.

The modes are entered through:

	Power Up	CE	PRIM_RX	TX FIFO
Power Down	0	-	-	
Standby	1	0	-	
RX	1	1	1	
TX	1	1	0	>0

There are two data transmission rates ... 1Mbps and 2Mbps. It is vital that both the transmitter and receiver devices use the same data rate.

The communications protocol used by the nRF24 devices is called "Enhanced ShockBurst". It has a dynamic payload length of between 1 and 32 bytes. What this means is that a single transmission can contain a maximum of 32 bytes of payload data. If we need to transmit additional data, we would send a stream of packets one after the other. Automatic transaction handling is also provided. We should think of a transaction as the request from the transmitter to send a packet and have the receiver pick it up. It is possible that there may be errors in the transmission. The transaction solution is to hold the transmitted data until there is a positive acknowledgment that the receiver has actually received it. If that doesn't happen, the transmitter can re-transmit the packet.

To set the size of the payload of a packet, we have two choices available to us ... these are static and dynamic payload sizes. For the static payload size, the receiver specifies the size of the payload and the sender must send that size before a transmission is complete. For dynamic payload, the transmitter can send a variable number of bytes before that packet is acknowledged as received by the receiver.

Each device has a configurable address. When data is transmitted from one device to another, the transmitter specifies the address of the receiver. An address can be between 3 and 5 bytes in length.

Devices communicate on a "channel". Think of this as a specific radio frequency bandwidth chunk. In order for a transmitter and receiver to talk to each other, they must both agree on the channel to be used. A channel is 7 bits in length (0 to 127). The default is channel 2.

The nRF24 has a variety of communication speeds including 1Mbps and 2Mbps.

A Cyclic Redundancy Check (CRC) can be applied to the payload to assist in detection of transmission errors. The CRC size can be set to be 8 bits or 16 bits.

The transmission power can be adjusted. The more transmission power you request the more overall power will be consumed and if you are running from batteries, this may be a consideration. There are four settings:

Output power	Current consumption
0dBm	11.3mA
-6dbM	9.0mA
-12dBm	7.5mA
-18dBm	7.0mA

A handy little addition to a nRF24 module is a YL-105. This is a connector board that hosts a nRF24 but also exposes the pins on the top in a line. One of the issues (at least to me) when working with nRF24s is that they have the pins pointing downwards and I have to do mental mirror imaging to get things right (and don't always).

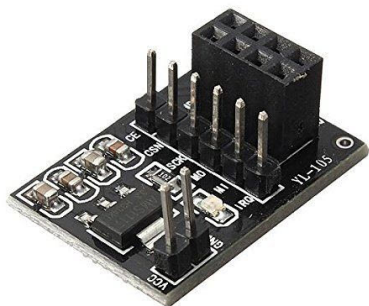

The pins are:

- CE
- CSN
- SCK
- MOSI
- MISO
- IRQ

and two further pins for:

- VCC
- GND

When pairing a couple of nRF24s, I find it useful to create a spreadsheet with two columns; one for each of the devices. We can then validate that the settings necessary to be paired on both are correct.

Attribute	Device A	Device B
Addr1	TX:	RX:
Addr2	RX:	TX:
Address Width		
RF_CH		
Data Rate		
CRC Length		

#### Notes:

- The air data rate must be the same on all participants.
- The RF channel frequency must be the same for all participants.

#### See also:

- [Nordic Semi – Home Page](#)
- [Data sheet](#)
- [SPI – Serial Peripheral Interface](#)
- [Tutorial: Ultra Low Cost 2.4 GHz Wireless Transceiver with the FRDM Board](#)
- [Julian Ilett #1](#)
- [NRF24L01 - How To](#)
- [Adding a nRF24L01 to a breadboard or stripboard](#)
- [Tutorial 0: Everything You Need to Know about the nRF24L01 and MiRF-v2](#)
- [YouTube: Getting started with the nRF24L01](#)

#### Using the Arduino APIs

An Arduino library for the nRF24 is available called RF24. This library is highly active and well documented. It appears to be a fork of the RF24 library originally created by Manicbug. It has a detailed set of documentation including descriptions of all the class APIs.

A typical flow would be:

```
RF24 radio(CE_PIN, CSN_PIN);
radio.begin();
radio.setPALevel(RF24_PA_LOW);
radio.openWritingPipe(addressTX);
radio.openReadingPipe(1, addressRX);
// To be a receiver ...
radio.startListening();
```

To stop being a receiver, call:

```
radio.stopListening();
```



Since there are only two modes, a receiver and a transmitter, when one stops being a receiver, one immediately becomes a transmitter.

To determine if there is data available to receive, call:

```
radio.available()
```

To read data, we can call:

```
radio.read(&buffer, length);
```

To write, we can call:

```
radio.write(&buffer, length);
```

The library comes with some samples.

- `GettingStarted` – Two devices. One can act as the transmitter and one as the receiver. They can be flipped around through user input from the serial port.

Before the library can be used, an instance of it must be constructed. The constructor looks as follows:

```
RF24(cePin, csPin)
```

The Arduino pins for `ce` and `cs` need not be fixed and hence we must instruct the library as to which pins we actually used. Take care that when an instance is created you specify the pins in the correct order as there is no guard against that.

Before any other functions can be called, we must call `begin()`. This performs the initialization of the device plus sets defaults for many of the operational parameters.

Every device has an address associated with it. This allows a transmission from one source device to be addressed to a specific destination device. When a transmission occurs, devices other than the one with the matching address will ignore the transmission. The device requires the size of the address to be supplied and fixed. The allowable address sizes are 3, 4 or 5 bytes. The default is 5 bytes. The size of the address can be changed with the `setAddressWidth()` method however you are unlikely going to want to change the default value. You must remember to supply the full data for the address. For example, don't set an address of "123" when the address size is 5 bytes as your device address will become "123<?><?>" and you will likely waste time trying to find out why no data is coming to you.

At this point, we must consider what we are going to do with the device from here on. The device has two modes of operation. It can transmit data or it can receive data but it can't do both simultaneously.

Let us look first at being a transmitter. First we create a "pipe" over which the data will flow. We supply the address of the destination.

```
openWritingPipe(const uint8_t *address)
```

For example:

```
uint8_t address = "1Node";  
openWritingPipe(address);
```

We are now ready to actually transmit some data.

```
bool write(const void *data, uint8_t length);
```

This method will transmit the data pointed to by the data pointer for the number of bytes supplied in length. There is a maximum size as specified by the `getPayloadSize()` method and you should not exceed that. The method will block until the data has been transmitted or the transmission request has timed out. The time out is short, about 70ms so you won't block for long. Upon return from the method call, we can determine whether the transmission was successful or if it failed. A return value of `true` means we succeeded while `false` means as failure.

The device has a maximum transmission size that is 32 bytes. You can not transmit packets larger than this. The default maximum transmission set in the library is 32 bytes which is the maximum that the device will permit. You can change this with the `setPayloadSize()` method but it is unlikely you will need that function. Simply remember that we can not ever send a payload size greater than 32 bytes.

The other mode of the device is that of a receiver where we actually listen for incoming data. As mentioned, the device can either be in transmit mode or receive mode.

To receive incoming data, we need to supply the address of the device from which we are expecting incoming data to arrive. We do this using the `openReadingPipe()` method.

```
openReadingPipe(uint8_t number, const uint8_t *address)
```

Once we have specified the address of the transmitting device we will receive data from, we can start actively listening using the `startListening()` method. Should we wish to end listening mode, we can call the `stopListening()` method which will return us to transmission mode.

Once we have entered listening mode, we can ask the library if there is data available for us to read. The method for this is `available()`. If there is data available, the return value is true and false otherwise.

To actually read the data that was received, we can use the method called `read()`.

```
read(void *buf, uint8_t len)
```

This method supplies a buffer into which the received data will be stored. The length of the buffer is also supplied.

A debug file called `printDetails()` is provided which logs the state of the nRF24 to the `stdout`. In order to use this one must:

- Include `<printf.h>`
- Call `printf_begin()`

When the `printDetails()` function is then called, a status of the nRF24 is written to the Serial port. This can be a powerful tool for debugging problems. Here is an example of the output:

```
STATUS          = 0x0e RX_DR=0 TX_DS=0 MAX_RT=0 RX_P_NO=7 TX_FULL=0
RX_ADDR_P0-1   = 0x0045444f4e 0x0045444f4e
RX_ADDR_P2-5   = 0xc3 0xc4 0xc5 0xc6
TX_ADDR        = 0x0045444f4e
RX_PW_P0-6     = 0x20 0x20 0x00 0x00 0x00 0x00
EN_AA          = 0x3f
EN_RXADDR      = 0x02
RF_CH          = 0x4c
RF_SETUP       = 0x03
CONFIG         = 0x0f
DYNPD/FEATURE = 0x00 0x00
Data Rate      = 1MBPS
Model          = nRF24L01+
CRC Length     = 16 bits
PA Power       = PA_LOW
```





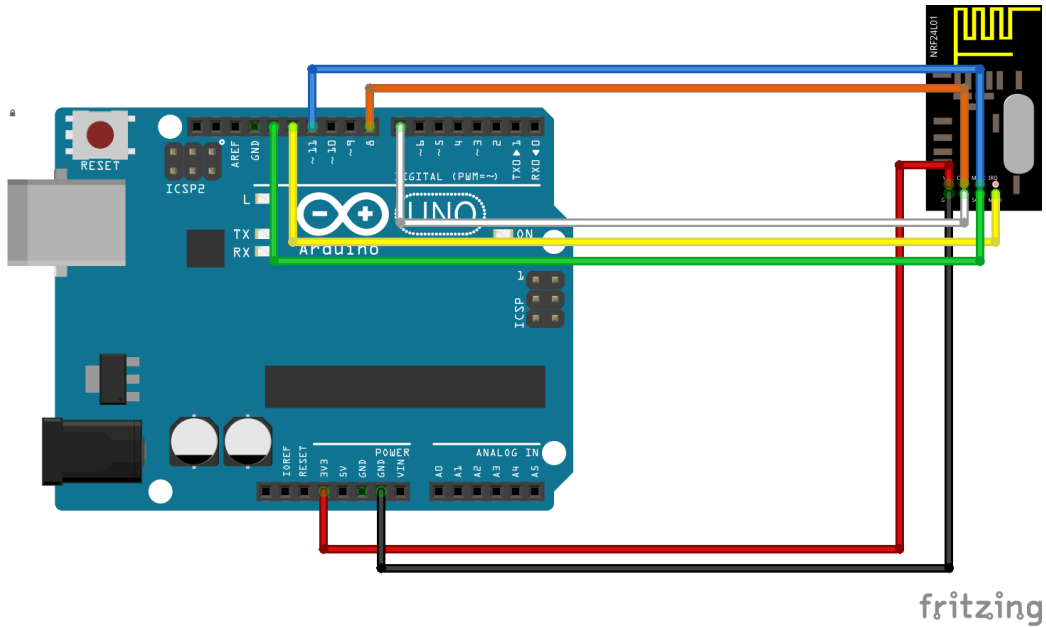

The complete API can be found documented at the project's web site but here is a quick summary:

Method	Notes
<code>bool begin()</code>	
<code>void startListening()</code>	Enter receiving mode.
<code>void stopListening()</code>	Enter transmitting mode.
<code>bool available()</code>	Returns true if there is data available to be read.
<code>void read( void *buf, uint8_t len)</code>	Read data.
<code>bool write( const void *buf, uint8_t len)</code>	One must call <code>stopListening()</code> before writing.
<code>void openWritingPipe( const uint8_t *address)</code>	Write data.
<code>void openReadingPipe( uint8_t number, const uint8_t *address)</code>	
<code>void setAddressWidth( uint8_t addressWidth)</code>	
<code>void setRetries( uint8_t delay, uint8_t count)</code>	
<code>void setChannel(uint8_t channel)</code>	
<code>uint8_t getChannel()</code>	
<code>void setPayloadSize(uint8_t size)</code>	
<code>uint8_t getPayloadSize()</code>	
<code>uint8_t getDynamicPayloadSize()</code>	
<code>void enableAckPayload()</code>	
<code>void enableDynamicPayloads()</code>	
<code>void enableDynamicAck()</code>	
<code>bool isPVariant()</code>	
<code>void setAutoAck(bool enable)</code>	
<code>void setAutoAck(uint8_t pipe, bool enable)</code>	
<code>void setPALevel(uint8_t level)</code>	
<code>uint8_t getPALevel(void)</code>	
<code>bool setDataRate( rf24_datarate_e speed)</code>	Values of the enumeration are: <ul style="list-style-type: none"> <li>• RF24_1MBPS</li> <li>• RF24_2MBPS</li> <li>• RF24_250KBPS</li> </ul>
<code>rf24_datarate_e getDataRate()</code>	Values of the enumeration are: <ul style="list-style-type: none"> <li>• RF24_1MBPS</li> </ul>

	<ul style="list-style-type: none"> <li>• RF24_2MBPS</li> <li>• RF24_250KBPS</li> </ul>
<pre>void setCRCLength(   rf24_crclength_e length)</pre>	Values of the enumeration are: <ul style="list-style-type: none"> <li>• RF24_CRC_DISABLED</li> <li>• RF24_CRC_8</li> <li>• RF24_CRC_16</li> </ul>
<pre>rf24_crclength_e getCRCLength()</pre>	Values of the enumeration are: <ul style="list-style-type: none"> <li>• RF24_CRC_DISABLED</li> <li>• RF24_CRC_8</li> <li>• RF24_CRC_16</li> </ul>
<pre>void disableCRC()</pre>	
<pre>void maskIRQ(   bool txOk,   bool txFail,   bool rxReady)</pre>	
<pre>void printDetails()</pre>	

Here is an example breadboard layout:

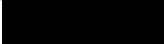

Arduino pin	nRF24 Function	Color code
Pin 13	SPI CLK	
Pin 12	MISO	
Pin 11	MOSI	
Pin 8	CSN	
Pin 7	CE	
3v3	3v3	
GND	GND	

Here is a sample to have an Arduino read data from the device:

```
#include <SPI.h>
#include <printf.h>
#include "RF24.h"

RF24 radio(7,8);

byte addressrx[5] = {0x11, 0x22, 0x33, 0x44, 0x55};

void setup() {
  Serial.begin(115200);

  radio.begin();
  radio.setPALevel(RF24_PA_HIGH);
  radio.setChannel(0x4c);
  radio.setCRCLength(RF24_CRC_8);
  radio.setDataRate(RF24_2MBPS);
  radio.setAddressWidth(5);
  radio.setRetries(5,15);
  radio.enableDynamicPayloads();
  radio.openReadingPipe(1,addressrx);
  radio.startListening();
  printf_begin();
  radio.printDetails();
} // End of setup

void loop()
{
  if (radio.available()){
    Serial.print("Size of payload is ");
    Serial.println(radio.getDynamicPayloadSize());
    while (radio.available()) {
      char buffer[33];
      uint8_t length = radio.getDynamicPayloadSize();
      radio.read(buffer, length);
      buffer[length] = 0;
      Serial.print("Received: ");
      Serial.println(buffer);
    }
  }
}
```

```
    }  
} // End of Loop
```

See also:

- [Github project](#) – tmrh20.github.io
- [Github project – source code](#)
- [Project Blog](#)
- [Forum thread](#)

### Integrating the nRF24 with the ESP32

Our goal will be to have the ESP32 interact with "something else" using nRF24 technology. This means that we will need **two** environments. One for our ESP32 and one for "something else". We could use two ESP32s but I tend to go for the simplest environments where possible. In addition, while we are developing and testing solutions, it is a good idea to have at least one known/reference environment. If we were working exclusively on the ESP32 and introduced an error it is likely that error would be on both environments and would either cancel each other out or result in something extremely difficult to diagnose.

As such, I recommend a simple Arduino environment with an attached nRF24. We can use a simple sketch on the Arduino that will listen for incoming network traffic and log it as it arrives. This then allows us to write the ESP32 side of the story and validate that it is working. If all is working, we will see ESP32 transmitted data arrive on the Arduino.

Here is an example ESP32 application.

```
#include <esp_log.h>  
#include <freertos/FreeRTOS.h>  
#include <freertos/task.h>  
#include <RF24.h>  
  
#include "sdkconfig.h"  
  
static char tag[] = "test_nrf24";  
  
extern "C" {  
    void task_test_nrf24(void *ignore);  
}  
  
void task_test_nrf24(void *ignore) {  
    RF24 rf24(25,15);  
    rf24.begin();  
    rf24.setPALevel(RF24_PA_HIGH);  
    rf24.setChannel(0x4c);  
    rf24.setCRCLength(RF24_CRC_8);  
    rf24.setDataRate(RF24_2MBPS);  
    rf24.setAddressWidth(5);  
}
```

```

rf24.setRetries(5,15);
rf24.enableDynamicPayloads();

rf24.printDetails();

uint8_t txAddress[5] = {0x11, 0x22, 0x33, 0x44, 0x55};
rf24.openWritingPipe(txAddress);
rf24.write("123", 3);
ESP_LOGD(tag, "Transmitted data");

ESP_LOGD(tag, "test done");
vTaskDelete(NULL);
}

```

and here is a corresponding example Arduino sketch:

```

#include <SPI.h>
#include <printf.h>
#include "RF24.h"

RF24 radio(7,8);

byte addressrx[5] = {0x11, 0x22, 0x33, 0x44, 0x55};

void setup() {
  Serial.begin(115200);

  radio.begin();
  radio.setPALevel(RF24_PA_HIGH);
  radio.setChannel(0x4c);
  radio.setCRCLength(RF24_CRC_8);
  radio.setDataRate(RF24_2MBPS);
  radio.setAddressWidth(5);
  radio.setRetries(5,15);
  radio.enableDynamicPayloads();
  radio.openReadingPipe(1,addressrx);
  radio.startListening(); // Become a receiver.
  printf_begin();
  radio.printDetails();
} // End of setup

void loop()
{
  if (radio.available()){
    Serial.print("Size of payload is ");
    Serial.println(radio.getDynamicPayloadSize());
    while (radio.available()) {
      char buffer[33];
      uint8_t length = radio.getDynamicPayloadSize();
      radio.read(buffer, length);
      buffer[length] = 0;
      Serial.print("Received: ");
      Serial.println(buffer);
    }
  }
}

```



```
    }  
} // End of Loop
```

When we run these, a message is sent from the ESP32 to the Arduino.

Now let us look at how to build an environment for running nRF24 on the ESP32. First, please realize that the library selected is based on C++. As such, you should be comfortable working in both C and C++ environments. In addition, since the nRF24 library from GitHub doesn't yet understand the ESP32 environment, we will have to augment the functions currently present with ESP32 logic. Rather than re-invent the wheel, we use classes from the example C++ ESP32 classes found here:

<https://github.com/nkolban/esp32-snippets>

Lets begin.

- Create a new ESP-IDF template application.
- Create a components directory.
- In the components directory, symbolic link to the cpp\_utils
- In the components directory, download the nRf24 library

```
$ git clone https://github.com/nRF24/RF24.git
```

- In the RF24 directory, create a file called component.mk that includes:

```
COMPONENT_ADD_INCLUDEDIRS=.  
COMPONENT_SRCDIRS=. utility/ESP_IDF
```

- Create the file called components/RF24/utility/includes.h which contains:

```
#ifndef __RF24_INCLUDES_H__  
#define __RF24_INCLUDES_H__  
  
#define RF24_ESP_IDF  
#include "ESP_IDF/RF24_arch_config.h"  
#include "ESP_IDF/RF24_ESP_IDF.h"  
#include "ESP_IDF/NRF24_spi.h"  
#endif
```

- Copy in the esp32-snippets/hardware/utility/ESP\_IDF directory

And that's it.

## Programming using Eclipse

Eclipse is a popular open source framework primarily used for hosting application development tools. Although primarily geared for building Java applications, it also has first class C and C++ support. At the time of writing, the currently available release of Eclipse is called "Neon".

Let us now look at how we can setup an Eclipse environment for an `ESP-IDF` template application.

1. Start with ESP-IDF installed and the environment variable `IDF_PATH` defined.
2. Make a directory called workspace and change into it.

```
$ mkdir workspace
$ cd workspace
```

3. Clone the template app into the workspace folder

```
git clone https://github.com/espressif/esp-idf-template.git myapp
```

4. Run the `make menuconfig` command to create the `sdkconfig` file.

```
$ cd myapp
$ make menuconfig
$ cd ..
```

5. Launch Eclipse.

6. When prompted for the workspace, provide the directory you just created

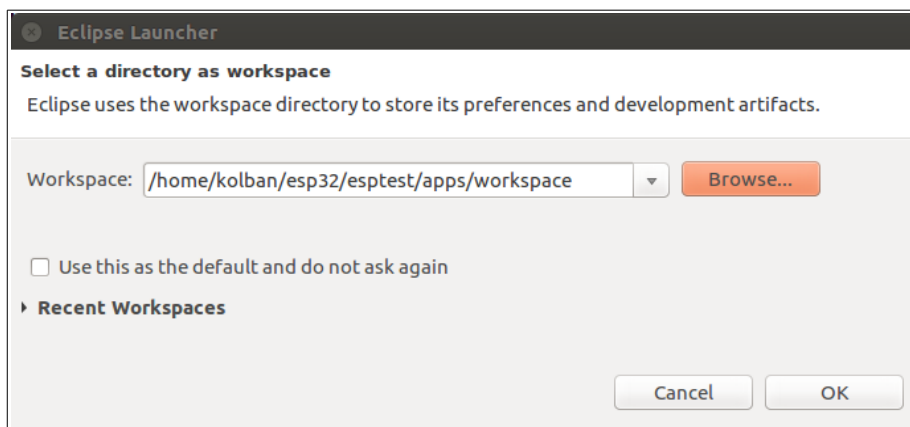

## 7. Switch to the C/C++ Perspective

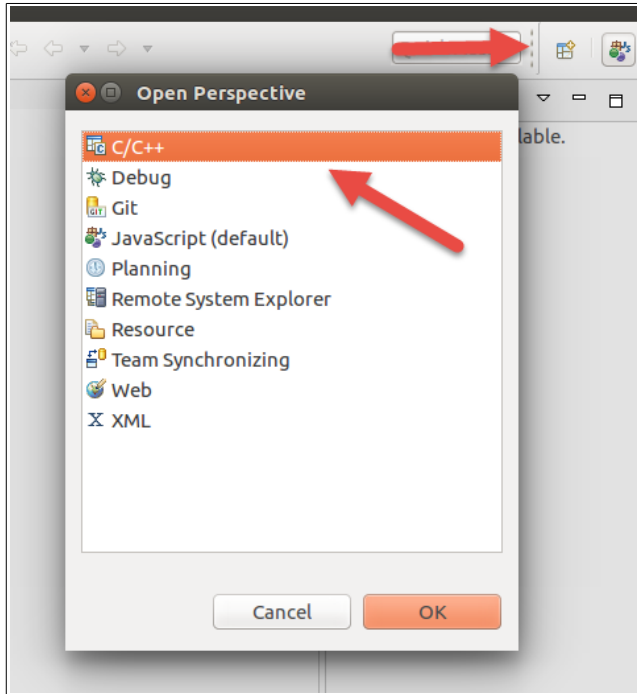

## 8. Create a new empty C project with the same name as your project (eg. `myapp`).

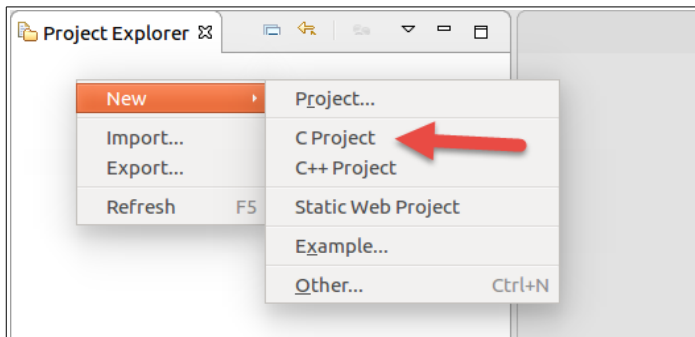

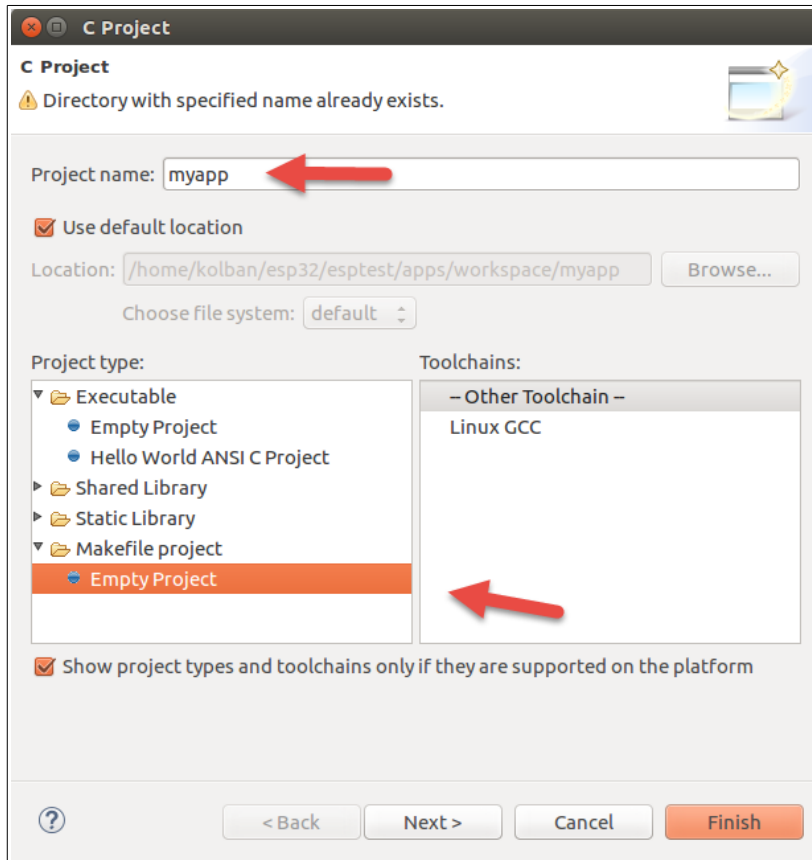

9. Open up the project properties and visit C/C++ Build. Change the settings to look as follows:

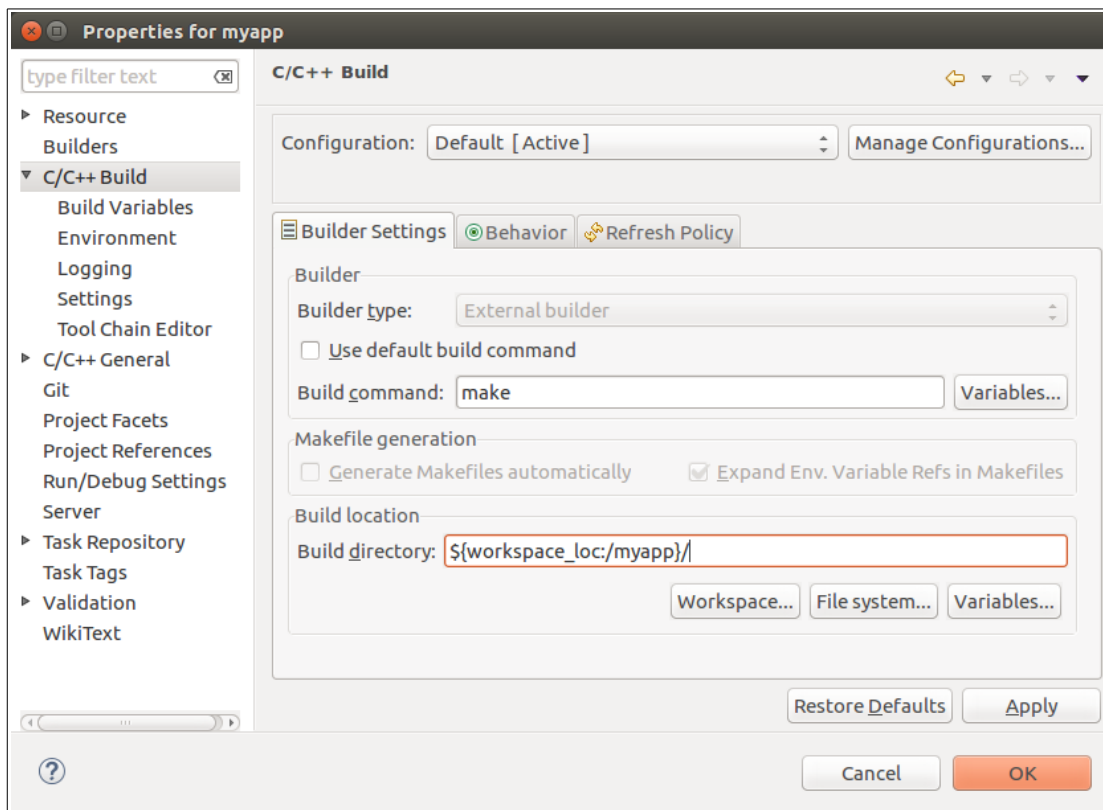

10. In the **global** properties set `C/C++ > Build > Environment` add two variables called `IDF_PATH` and `PATH` as shown:

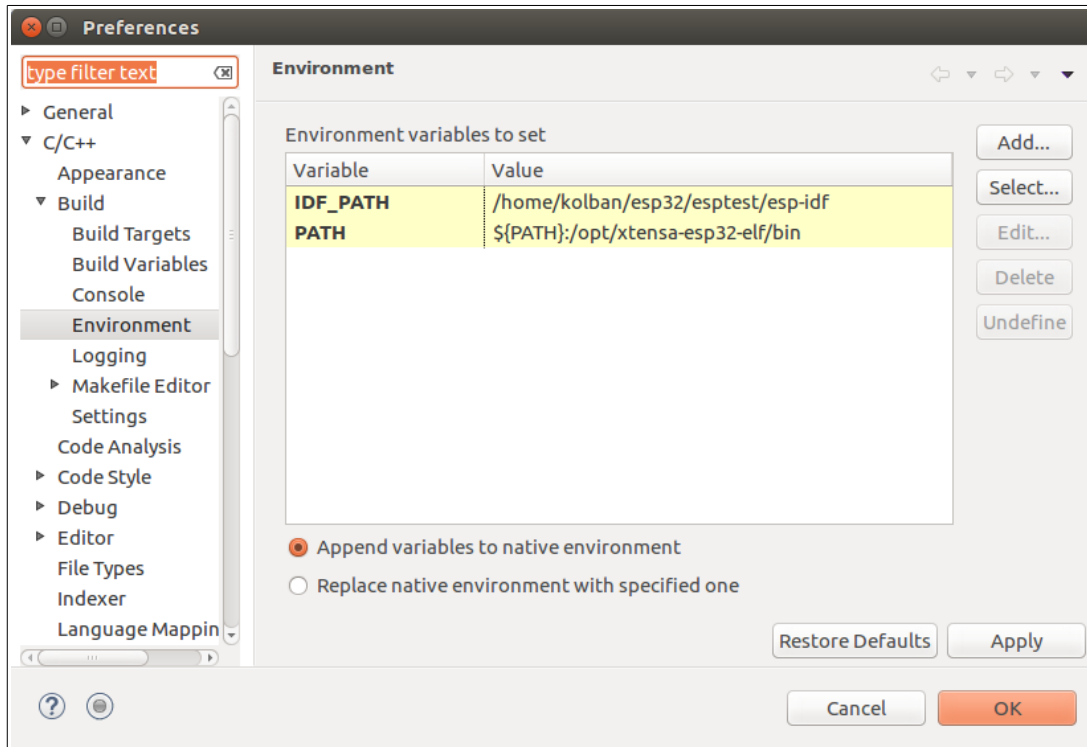

The `IDF_PATH` variable points to the root of your ESP-IDF installation and the path `PATH` is augmented to point to the Xtensa ESP32 tool chain.

11. Open the properties dialog called `C/C++ General > Paths and Symbols` and add the following:

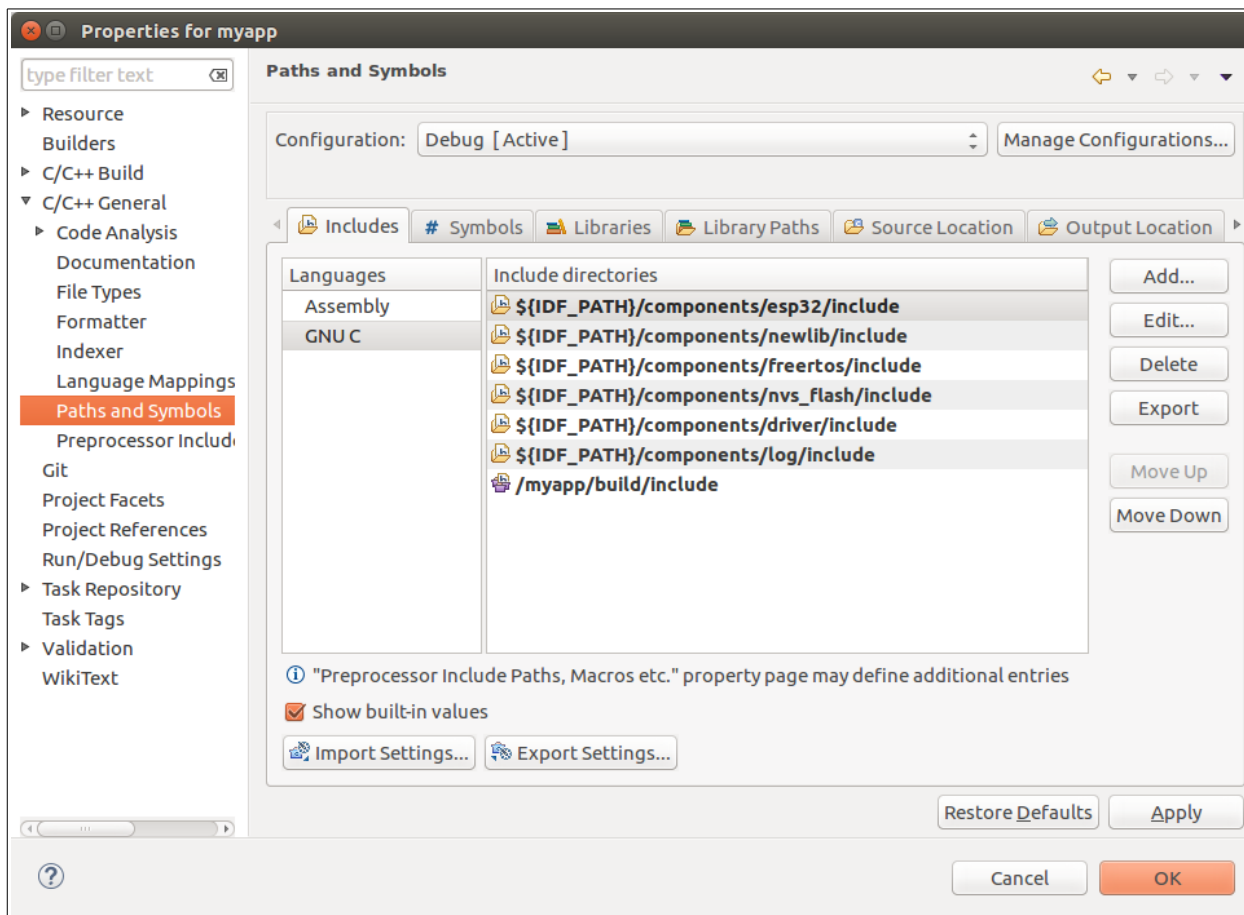

Also ... components/tcpip\_adapter/include

Also ... components/lwip/include/lwip

Also ... components/spi\_flash/include

What this does is tell the Eclipse tooling where to go look for include directories to satisfy the inclusions from the C source files.

12. Add a build target for the Makefile called `all`:

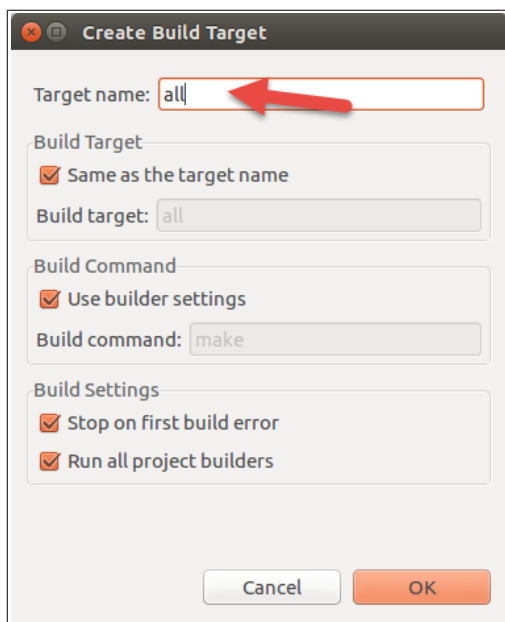
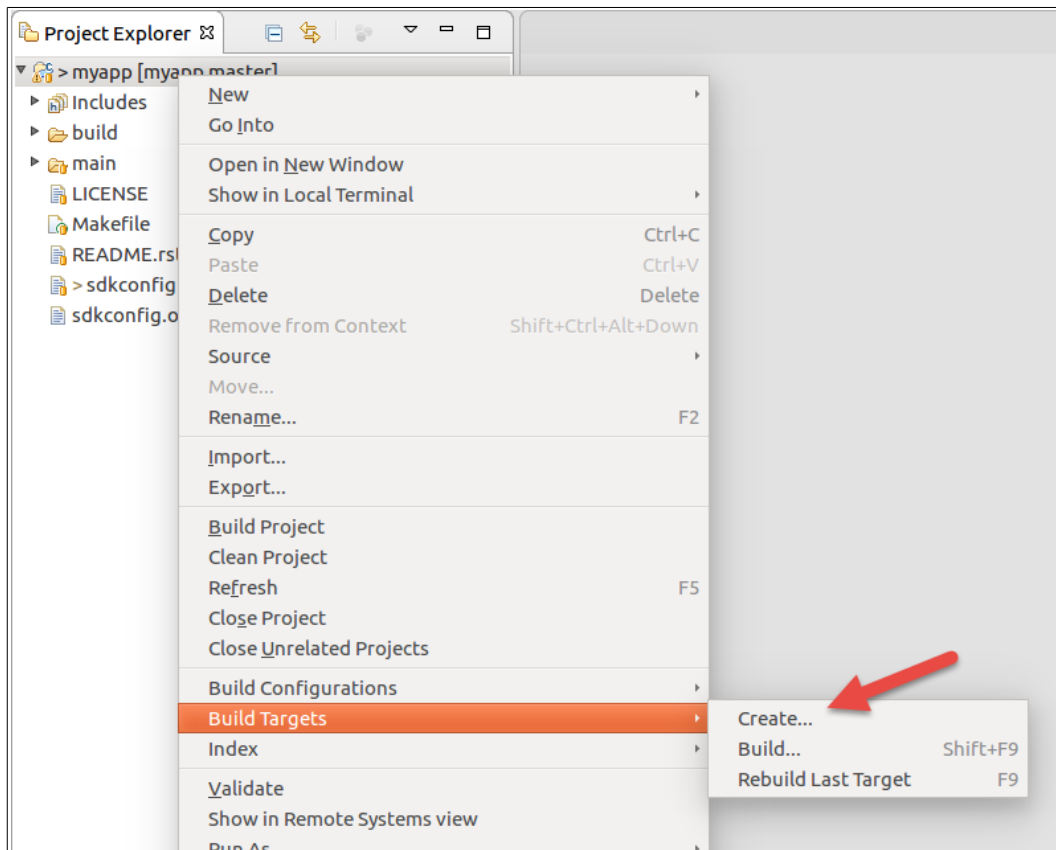

13. Run Build Targets > all:



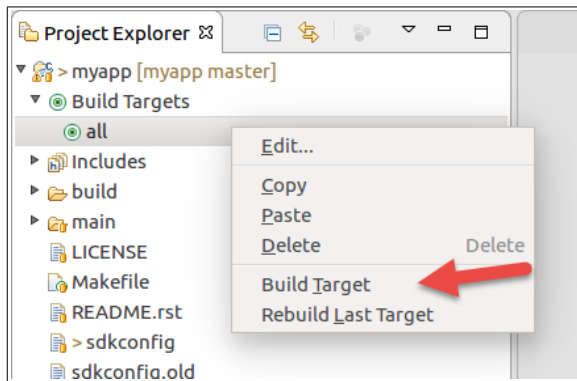

This causes the Makefile for the project to be run and the compilation proceeds.

#### 14. Examine the console.

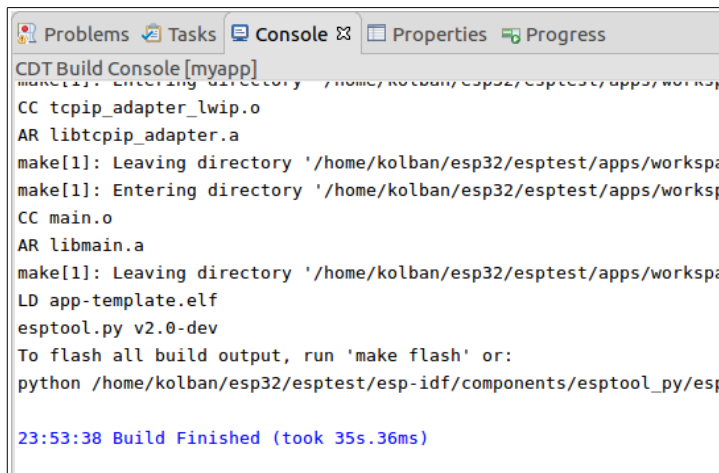

We should see a clean build.

And with that you have build a binary. Now if you edit the source files and re-build the Makefile target called "all", only the changed files will be shown. Should there be a compilation error, we will see them all highlighted in the console, in the code and in the project explorer. Double clicking in the console will take us to the associated source file and line within that source file.

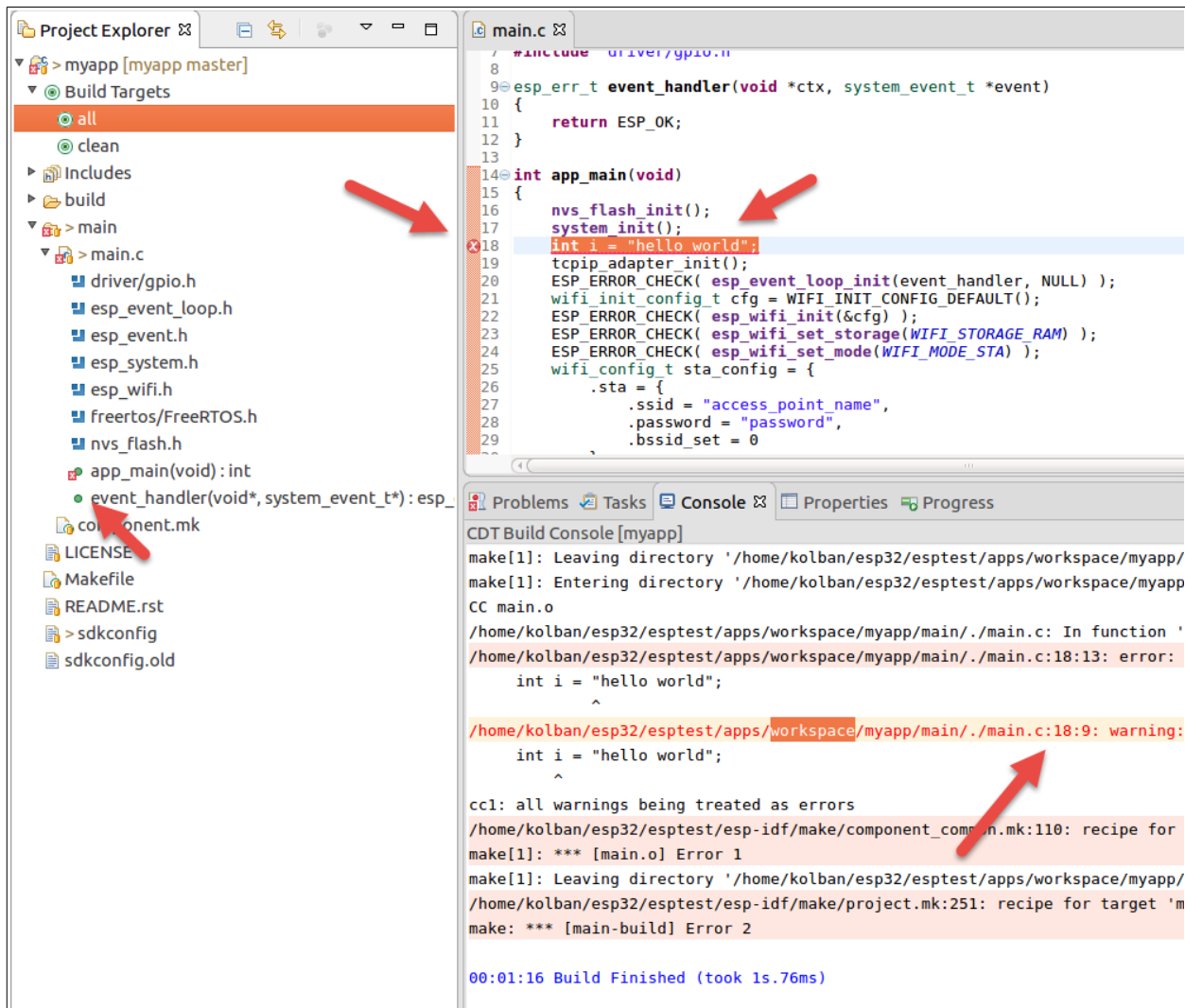

You can also add other build targets such as:

- `flash` – To perform a flash of your application against your ESP32.
- `clean` – To clean the current build.

Short cuts are also available for some of the more common tasks. For example:

- `F9` – Will re-execute the last build you performed.
- The menu bar entry  will perform a "make all".

Here are some additional Eclipse tips I recommend:

- By default, any changed files are **not** saved before building. I often find I make a change and rebuild and test only to find no difference in execution only to realize

that what I built did not include my changes because I hadn't saved the source file. We can automate the saving of source files before a build by setting the preferences entry in `General > Workspace` and checking "Save automatically before build":

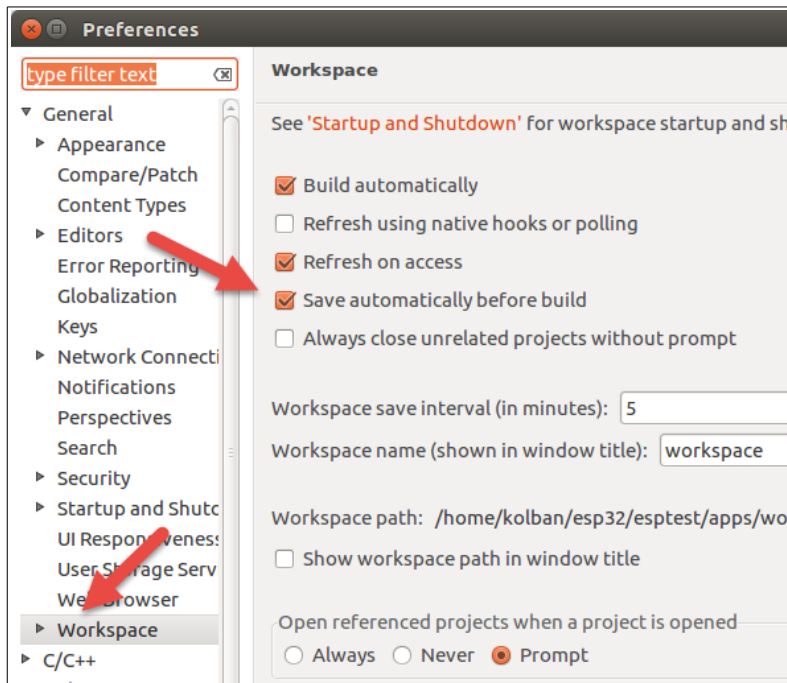

- Install the Eclipse Path Tools package.
- The primary editor font and font size can be changed at the preferences setting located at `General > Appearance > Colors and Fonts | C/C++ > Editor > C/C++ Editor Text Font` and then clicking "Edit...":

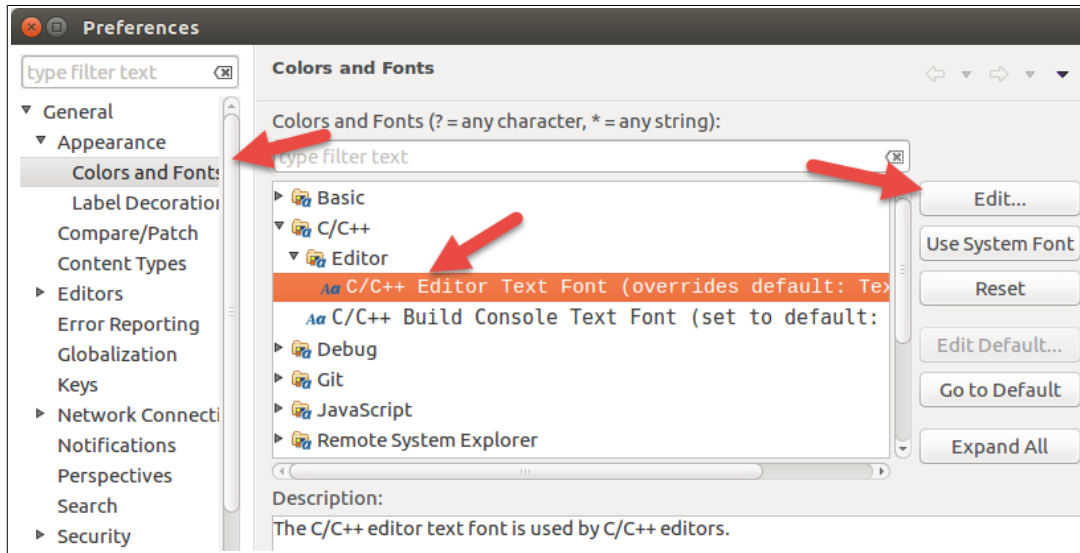

My personal preference is "Liberation Mono" at 11pt.

## Installing the Eclipse Serial terminal

Note: My retests of this crash Eclipse. I have since switched to opening a shell within Eclipse and running minicom within the shell.

Although there are many excellent serial terminals available as stand-alone Windows applications, an alternative is the Eclipse Terminal which also has serial support. This allows a serial terminal to appear as a view within the Eclipse IDE. It does not come installed by default but the steps to add are not complex.

First start Eclipse (I use the Luna release).

Go to `Help > Install new software...`

Select the eclipse download repository.

Select `General Purpose Tools > TM Terminal via Remote API Connector Extensions`

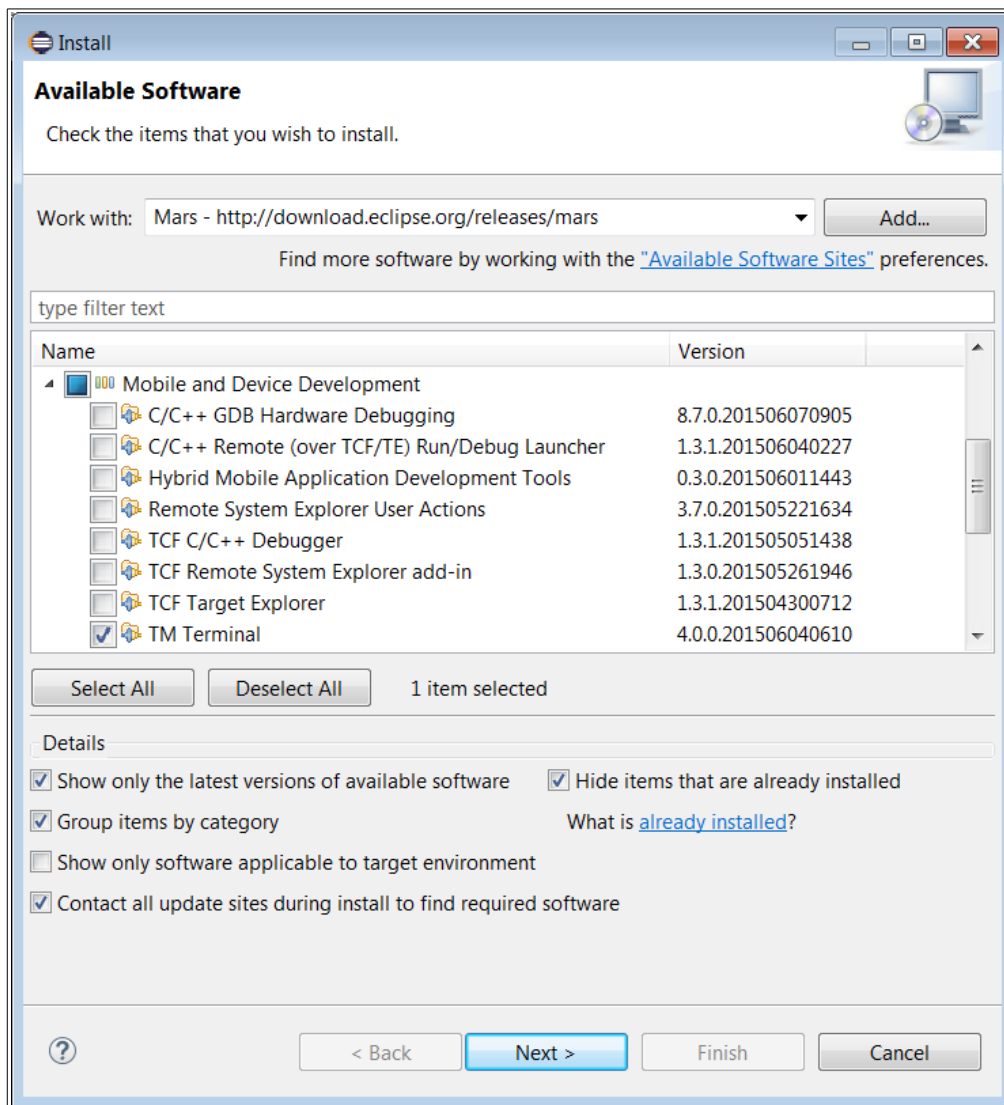

Step through the following sections and when prompted to restart, accept yes.

We are not ready to use it yet, we must add serial port support into Eclipse.

Go back to `Help > Install new software` and add a new repository

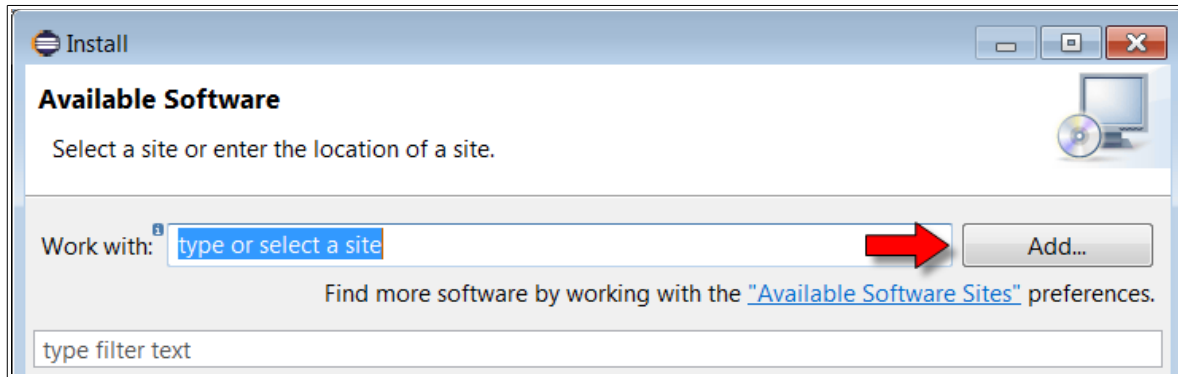

The repository URL is:

- <http://archive.eclipse.org/tm/updates/rxtx/>

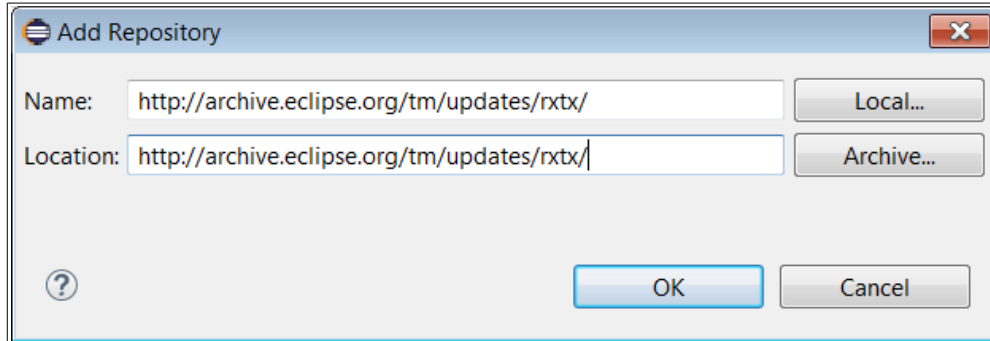

Now we can select the Serial port run-time support library:

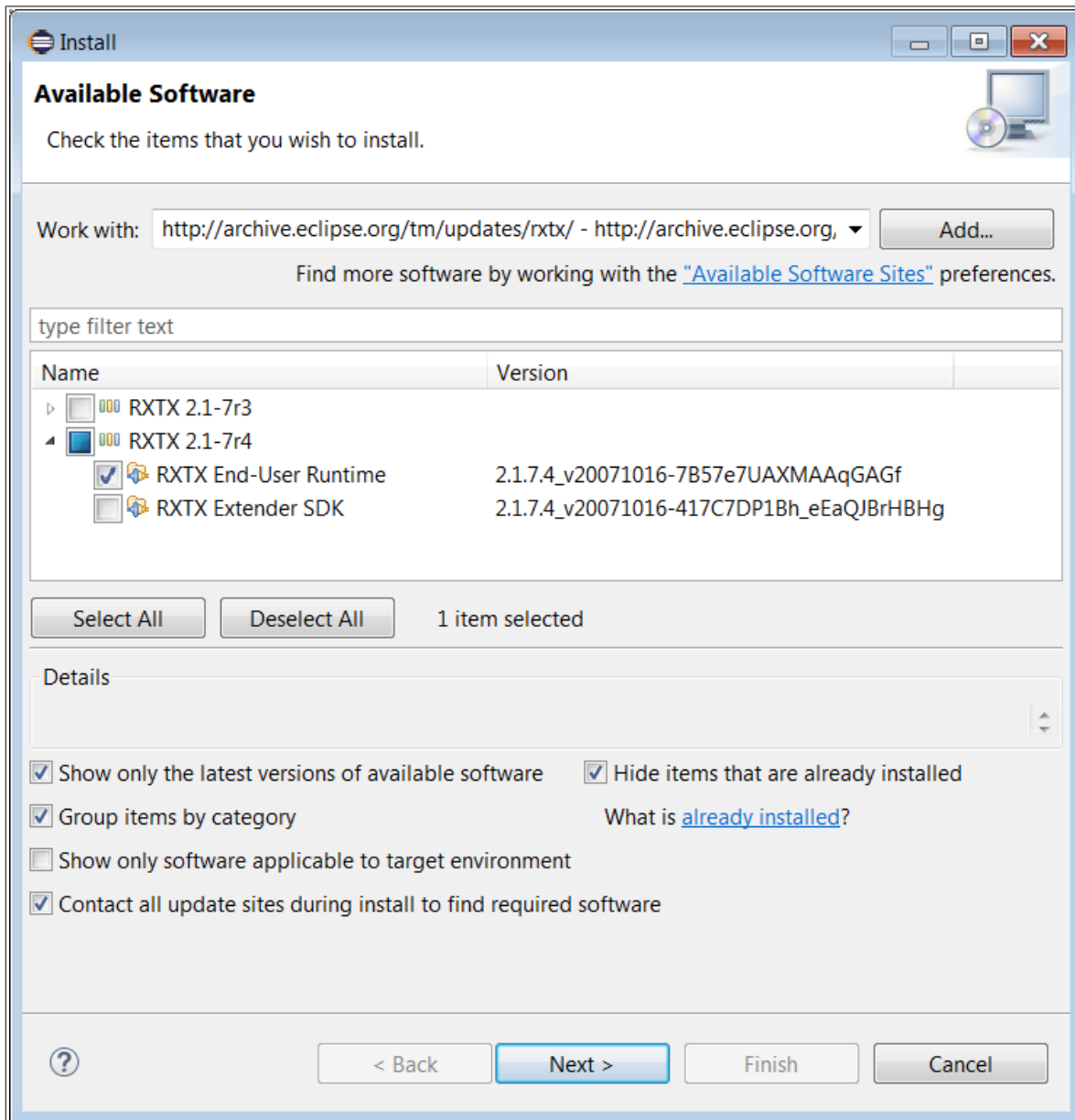

Follow through the further navigation screens and restart Eclipse when prompted.

We now have terminal support installed and are ready to use it. From `Windows > Show View > Other` we will find a new category called "Terminal".

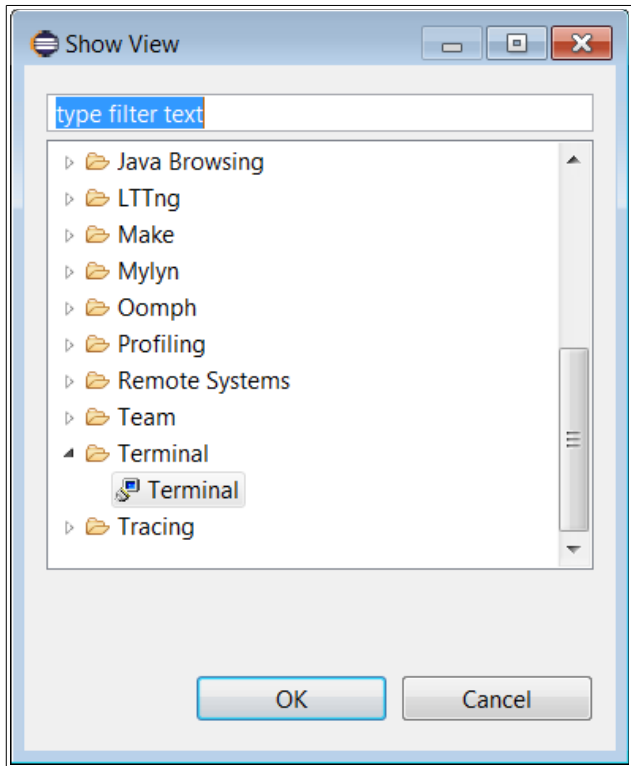

Opening this adds a Terminal view to our perspective. There is a button that will allow us to open a new terminal instance that is shown in the following image:

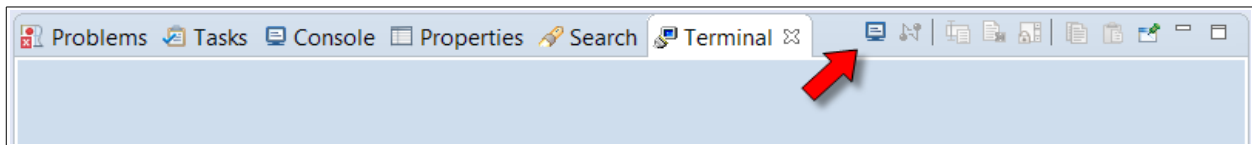

Clicking this brings up the dialog asking us for the type of terminal and the properties. For our purposes, we wish to choose a serial terminal. Don't forget to also set the port and baud rate to match what your ESP8266 uses.



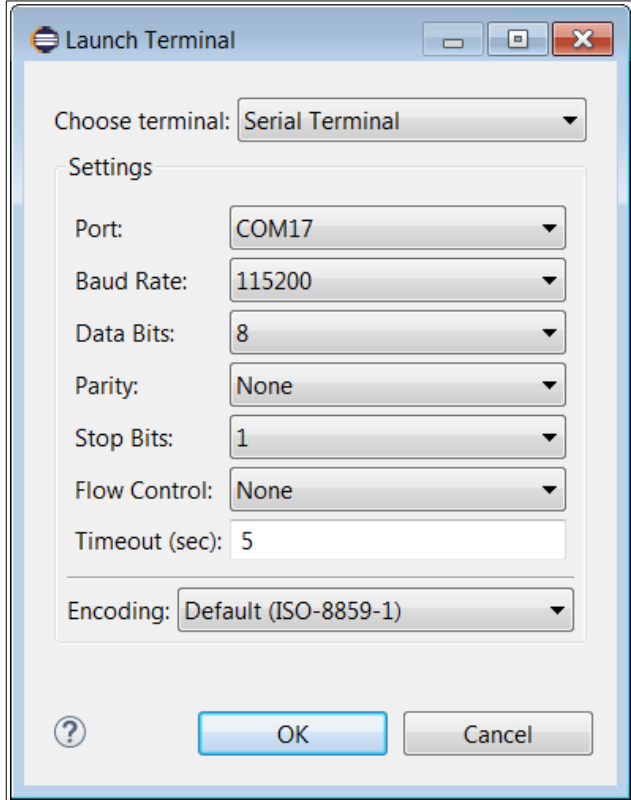

After clicking OK, after a few seconds we will see that we are connected and a new disconnect icon appears:

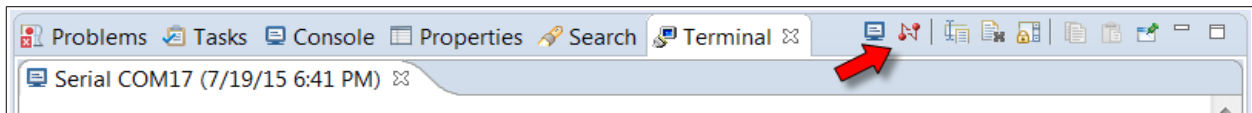

And now the terminal is active.

You can invert the colors to produce a white on black visualization which many users prefer.

## Web development using Eclipse

Eclipse also provides a first class web development environment for writing and testing web apps including HTML pages. It is suggested that the Eclipse Web Developer Tools be installed.

## Programming using the Arduino IDE

Long before there was an ESP8266 or ESP32, there was the Arduino. A vitally important contribution to the open source hardware community and the entry point for a huge number of hobbyists into the world of home built circuits and processors.

One of the key attractions about the Arduino is its relative low complexity providing almost anyone the ability to build something quickly and easily. The Integrated Development Environment (IDE) for the Arduino has always been free of charge for download from the Internet. If a professional programmer were to sit down with it, they would be shocked at its apparent limited capabilities. However, the subset of function it provides compared to a "full featured" IDE happens to cover 90% of what one wants to achieve. Combine that with the intuitive interface and the Arduino IDE is a force to be reckoned with.

Here is what a simple program looks like in the Arduino IDE:

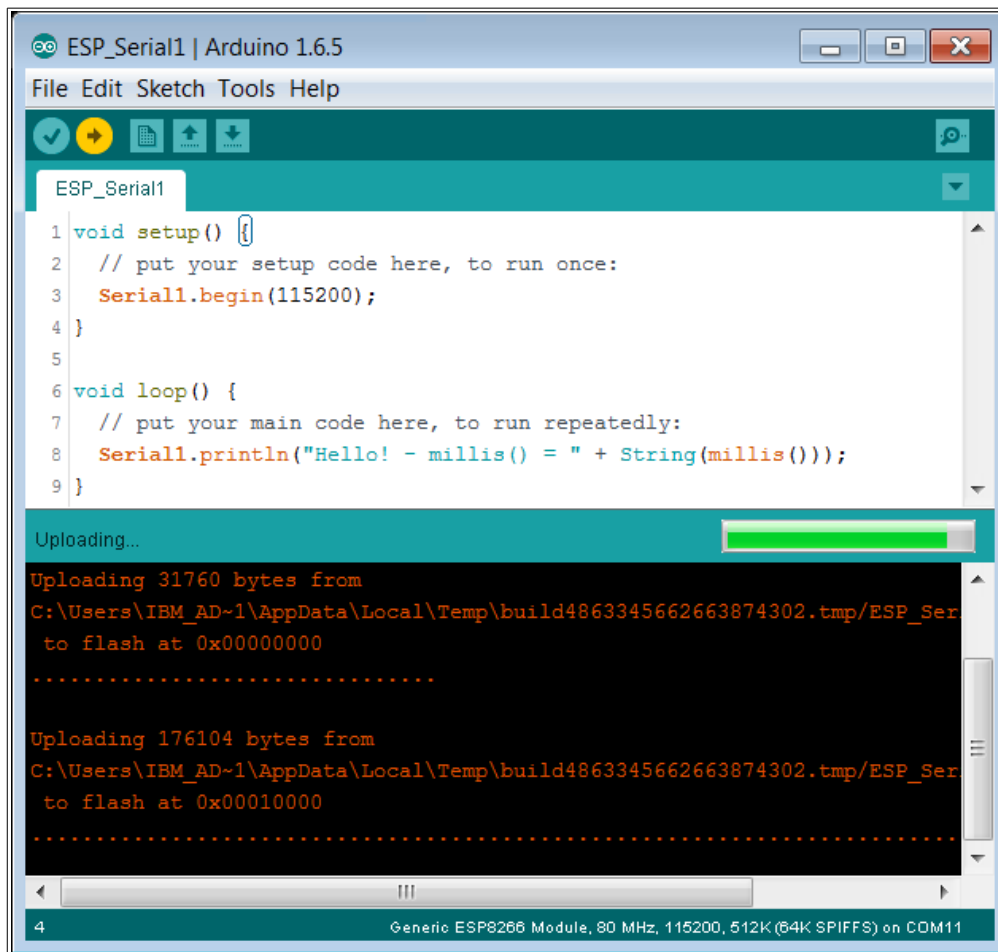
The image shows a screenshot of the Arduino IDE interface. The window title is "ESP\_Serial1 | Arduino 1.6.5". The menu bar includes "File", "Edit", "Sketch", "Tools", and "Help". The toolbar contains icons for checking, running, uploading, and downloading. The main editor area shows the following code:

```
1 void setup() {  
2   // put your setup code here, to run once:  
3   Serial1.begin(115200);  
4 }  
5  
6 void loop() {  
7   // put your main code here, to run repeatedly:  
8   Serial1.println("Hello! - millis() = " + String(millis()));  
9 }
```

Below the code editor, there is a progress bar labeled "Uploading..." which is partially filled with green. Below the progress bar, the serial monitor shows the following output:

```
Uploading 31760 bytes from  
C:\Users\IBM_AD~1\AppData\Local\Temp\build4863345662663874302.tmp/ESP_Ser  
to flash at 0x00000000  
.....  
Uploading 176104 bytes from  
C:\Users\IBM_AD~1\AppData\Local\Temp\build4863345662663874302.tmp/ESP_Ser  
to flash at 0x00010000  
.....
```

At the bottom of the IDE, the status bar indicates "4 Generic ESP8266 Module, 80 MHz, 115200, 512K (64K SPIFFS) on COM11".

In Arduino parlance, an application is termed a "sketch". Personally, I'm not a fan of that phrase but I'm sure research was done to learn that this is the least intimidating name

for what would otherwise be called a C language program and that would intimidate the least number of people.

The IDE has a button called "Verify" which, when clicked, compiles the program. Of course, this will also have the side-effect that it will verify that the program compiles cleanly ... but compilation is what it does. A second button is called "Upload" that, when clicked, uploads the application to the Arduino board.

In addition to providing a C language editor plus tools to compile and deploy, the Arduino IDE provides pre-supplied libraries of C routines that "hide" complex implementation details that might otherwise be needed when programming to the Arduino boards. For example, UART programming would undoubtedly have to set registers, handle interrupts and more. Instead of making the poor users have to learn these technical APIs, the Arduino folks provided high level libraries that could be called from the sketches with cleaner interfaces which hide the mechanical "gorp" that happens under the covers. This notion is key ... as these libraries, as much as anything else, provide the environment for Arduino programmers.

Interesting as this story may be, you may be asking how this relates to our ESP32 story? Well, a bunch of talented individuals have built out an Open Source project on Github that provides a "plug-in" or "extension" to the Arduino IDE tool (remember, that the Arduino IDE is itself free). What this extension does is allow one to write sketches in the Arduino IDE that leverage the Arduino library interfaces which, at compile and deployment time, generate code that will run on the ESP32. What this effectively means is that we can use the Arduino IDE and build ESP32 applications with the minimum of fuss.

### **Mapping from the Arduino to the ESP32**

Obviously, an actual, physical Arduino is not the same thing as an ESP32 and as such, assumptions about the Arduino hardware don't map to the same things on the ESP32.

ESP32 Dev Board PINMAP

					3.3V								GND						
(pu)			RESET		EN								GPIO23	VSPI MOSI					SPI MOSI
SVP		ADC0			GPIO36								GPIO22						Wire SCL
SVN		ADC3			GPIO39								GPIO1	TX0					Serial TX
		ADC6			GPIO34								GPIO3	RX0					Serial RX
		ADC7			GPIO35								GPIO21						Wire SDA
	TOUCH9	ADC4			GPIO32								GND						
	TOUCH8	ADC5			GPIO33								GPIO19	VSPI MISO					SPI MISO
DAC1		ADC18			GPIO25								GPIO18	VSPI SCK					SPI SCK
DAC2		ADC19			GPIO26								GPIO5	VSPI SS				(pu)	SPI SS
	TOUCH7	ADC17			GPIO27								GPIO17						
	TMS	TOUCH6	ADC16	HSPI SCK	GPIO14								GPIO16						
(pd)	TDI	TOUCH5	ADC15	HSPI MISO	GPIO12								GPIO4		ADC10	TOUCH0		(pd)	
					GND								GPIO0	BOOT	ADC11	TOUCH1			(pu)
	TCK	TOUCH4	ADC14	HSPI MOSI	GPIO13								GPIO2		ADC12	TOUCH2			(pd)
				FLASH D2	GPIO9								GPIO15	HSPI SS	ADC13	TOUCH3	TDO		(pu)
				FLASH D3	GPIO10								GPIO8	FLASH D1					
				FLASH CMD	GPIO11								GPIO7	FLASH D0					
					5V								GPIO6	FLASH SCK					

Here we discuss some of the distinctions:

- I2C and the Wire library – The default pins on the ESP32 for the I2C and Wire library are GPIO21 for SDA and GPIO22 for SCL.

### Implications of Arduino IDE support

The ability to treat an ESP32 as though it were "like" an Arduino is a notion that I haven't been able to fully absorb yet. ESP32 is a Tensilica CPU unlike the Arduino which is an ATmega CPU. Espressif have created dedicated and architected API in the form of their SDK for directly exposed ESP32 APIs. The Arduino libraries for ESP32 seem to map their intent to these exposed APIs. For these reasons and similar, one might argue that the Arduino support is an unnecessary facade on top of a perfectly good environment and by imposing an "alien" technology model on top of the ESP32 native functions, we are masking access to lower levels of knowledge and function. Further, thinking of the ESP32 as though it were an Arduino can lead to design problems. For example, the ESP32 needs regular control in order to handle WiFi and other internal actions. This conflicts with the Arduino model where the programmer can do what he wants within the loop function for as long as he wants.

The flip side is that the learning curve to get something running on an Arduino has been shown to be extremely low. It doesn't take long at all to get a blinky light going on a breadboard. With that train of thought, why should users of the ESP32 be penalized for having to install and learn more complex tool chains and syntax to achieve the same result with more ESP32 oriented tools and techniques? The name of the game should be to allow folks to tinker with CPUs and sensors without having to have university

degrees in computing science or electrical engineering and if the price one pays to get there is to insert a "simple to use" illusion then why not? If I build a paper airplane and throw it out my window ... I may get pleasure from that. A NASA rocket scientist shouldn't scoff at my activities or lack of knowledge of aerodynamics ... the folded paper did its job and I achieved my goal. However, if my job was to put a man on the moon, the ability to visualize the realities of the technology at the "realistic" level becomes extremely important.

## Installing the Arduino IDE with ESP32 support

The Arduino IDE support for ESP32 can be found on Github here.

<https://github.com/espressif/arduino-esp32>

First we download and install an Arduino IDE at 1.8.4 or later. We then follow the installation/configuration instructions which are:

1. Enter the Arduino installation directory

2. Change into the "hardware" directory:

```
$ cd hardware
```

3. Make a directory called "espressif":

```
$ mkdir espressif
```

4. Change into the "espressif" directory:

```
$ cd espressif
```

5. Download the ESP32 package for Arduino:

```
$ git clone https://github.com/espressif/arduino-esp32.git esp32
```

6. Change into the "esp32" directory

```
$ cd esp32
```

7. Update any sub-modules

```
$ git submodule update --init
```

## 8. Change into the "tools" directory:

```
$ cd tools
```

## 9. Run the supplied "get.py" script

```
$ python get.py
```

What this script does is download the tool chain to perform the compilations.

## 10. Start Arduino IDE

## 11. Pick "ESP32 Dev Module" from the Boards:



To enable debugging in the Arduino environment, we can select `Tools > Core Debug Level` and select one of the available values.

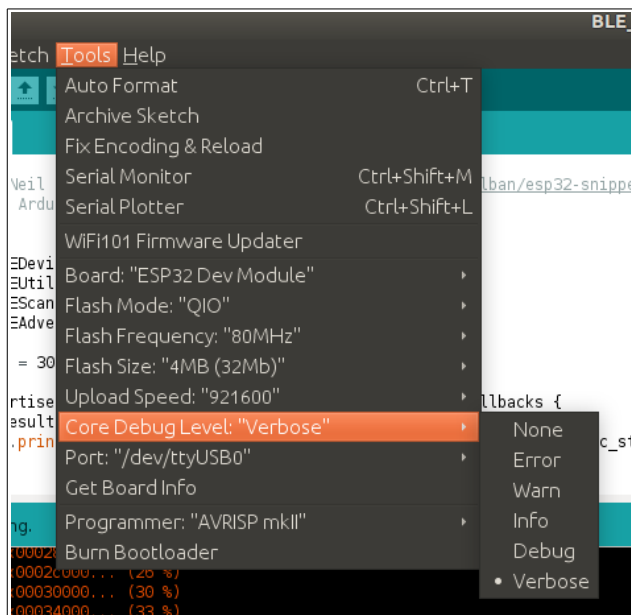

## Using the Arduino libraries as an ESP-IDF component

Now comes the capability that excites me the most. By now we should be fully appreciative of the capabilities provided by the ESP-IDF and realize that it is component driven. This means that as we need functions, we can "drop them in" as components as long as they conform to the governance rules of the ESP-IDF.

The Arduino libraries can be used as an ESP-IDF component.

Let that sink in for a few moments. What this effectively means is that all the functions provided by the Arduino ESP32 libraries are available to us in our "normal" ESP-IDF applications. This is huge!! It opens up a world of possibilities for us.

Now let us look at how we go about using the Arduino libraries in our project. Let us imagine that we have created a new ESP-IDF template application by using:

```
$ git clone https://github.com/espressif/esp-idf-template.git myapp
```

Now we want to perform this recipe:

1. Create a new directory called "components" in the app directory.

```
$ mkdir components
```

2. Change into the components directory.

```
$ cd components
```

3. Install the Arduino-ESP32 library relative to here by performing a Github Clone:

```
$ git clone https://github.com/espressif/arduino-esp32.git
```

And that's it!! We can now build our sample application as normal.

## Tips for working in the Arduino environment

Remember that the Arduino environment is two things. First, an actual application that you install on your machine providing the Arduino IDE. Second, a set of libraries that model those available to an actual Arduino device which are mapped to ESP\* capabilities. With that in mind, here are some hints and tips that I find useful when writing Arduino sketches for an ESP32 environment.

### Initialize global classes in setup()

Within an Arduino sketch, we have a pre-supplied function called `setup()` that is called only once during ESP32 boot-up. Within this function, you perform one time initialization functions. In C++, we have the ability to create class instances globally. For example:

```
MyClass myClass(123);

void setup() {
    // Some code here
}
```

instead of this, use the following:

```
MyClass *myClass;

void setup() {
    myClass = new MyClass(123);
    // Some code here
}
```

This of course changes your variable's data type. It went from being an instance of `MyClass` to being a pointer to an instance of `MyClass` which means that you might have to change other aspects of your program ... but the reason for this is that in the first case, the constructor for your `MyClass` instance ran outside of the `setup()` and we can't say what state the environment might have been in at that point. Within the `setup()` code, we have a reasonable expectation of the environment context.

### Invoking Espressif SDK API from a sketch

- There is nothing to prevent you from invoking Espressif SDK API from within your sketch. You must include any include files that are necessary. Here is an example of including "xxxx.h".



```
• extern "C" {  
    #include "XXXX.h"  
}
```

Notice the bracketing with the C++ construct that causes the content to appear as though it were being defined in a C program.

### Reasons to consider using Eclipse over Arduino IDE

As previously mentioned, there is no question that the Arduino IDE is much more friendly and consumable than the professional Eclipse environment for folks new to the area. There doesn't appear to be anything that one can't build using the Arduino IDE that would mean one would have to switch to Eclipse. So why then would one ever consider using Eclipse?

There is a trade-off between ease of use and richness of function. For example, Eclipse has built-in syntax assistance, error checking, code cross-references, refactoring and much more. None of these things are "essential" but any one of them can be considered to make a programming job easier if and when needed. If I need to rename a variable, in Arduino IDE I have to manually find and replace each occurrence. In Eclipse, I can re-factor the variable using a built-in wizard and the IDE does the work for me. As another example, if I can't remember the syntax for a method, in Arduino IDE I would go to the web and look it up while in Eclipse I could type the name of the method and hover my mouse over it and the tooling will show me the possible options for the parameters.

## Programming with JavaScript

JavaScript is a high-level interpreted programming language. Some of its core constructs are loose typing, object-oriented, support of lambda functions, support of closures and, most importantly, has become **the** language of the web. If one is writing a browser-hosted application, then it is a certainty that it will be written in JavaScript. But what of non-browser environments? For a while now JavaScript has been moving into server-side code through projects such as Node.js. As a language for running server code, it has a significant set of features to realize this capability. Specifically, it supports an event-driven architecture paradigm. In JavaScript, we can register functions to be called back upon events being detected. These callbacks can be defined as simple inline functions on what to do. In these made-up examples, we illustrate this:

```
httpServer.on("/path1", function() {  
    // Do something for /path1
```

```
    httpServer.send(response);
});
```

or

```
socket.accept(port, function(newSocket) {
    newSocket.on("receive", function(data) {
        print("We received new data: " + data);
        newSocket.send("We got the data", function() {
            newSocket.close();
        });
    });
});
```

And if we can implement a good JavaScript model, it maps excellently to the ESP32 model of the world which is itself event driven via callbacks. This mapping won't be easy ... but plans are afoot.

The Duktape and Jerry Script engines provide excellent access to standard JS run-times. In addition Espruino is an open source project to provide a JavaScript run-time for embedded devices. It has been implemented for the ARM Cortex M3/M4 processors and others.

The question now is ... can these be used for the ESP32? Active projects are attempting to do just that.

See also:

- [ESP32-Duktape](#)
- [Espruino](#)

## Duktape

Duktape is an open source implementation of JavaScript written exclusively in highly portable C with minimal footprint or requirements. It lends itself extremely well to running in embedded systems such as an ESP32.

Being open source, one wondered if it would be able to build as an ESP-IDF component and ... yes it does. A project is now under way to provide a distribution.

The core pattern for usage is:

1. Create a context
2. Evaluate JavaScript
3. Delete the context

We create a context by calling `duk_create_heap_default()`.

To evaluate a JavaScript string, we call `duk_eval_string()`.

To delete the context we call `duk_destroy_heap()`.

See also:

- [duktape.org](http://duktape.org)
- [duktape API reference](#)

## Compiling code

The JavaScript that is to be run can be executed in a variety of ways:

- `duk_eval` – Evaluate code on the stack.
- `duk_compile` – Compile code on the stack and leave it there as a function to be called.
- `duk_compile_lstring` – Compile a string representation of JavaScript with a specific length.
- `duk_compile_file` – Compile a file containing JavaScript.
- `duk_compile_lstring_filename` –
- `duk_compile_string` – Compile a NULL terminated string.
- `duk_compile_string_filename` – Compile a source file whose identity is on the stack.

To invoke the code, we can either use one of the `duk_eval()` functions which compile and execute or else we can compile and then invoke with `duk_call()`.

## Building for ESP32

To our absolute delight, Duktape compiled first time using the ESP-IDF environment without any issues at all.

## Integrating Duktape in an ESP32 application

To use Duktape in a C program we must include `"duktape.h"`.

We create a context for our JavaScript execute environment using

`duk_create_heap_default()`.

## The Duktape stack

To work with Duktape C API is unusual relative to some other programming languages and concepts. It is based on a solid understanding of stack processing concepts such as push and pop and the stack frame in which we are working.

## Working with object properties

Imagine we wish to set a property on an object. First we push that object onto the stack. Next we push the name and then the value onto the stack. Finally we call `duk_put_prop()` and here is where the magic happens. The top two items are popped from the stack and considered to be the name and value. Next, the object given by its location on the stack from the top has a property created on it given by `name` and set to the value given by `value`. There are variants of this function including:

- `duk_put_prop` – Pop the top 2 items and use as name and value.
- `duk_put_prop_index` – Pop the value from the stack and set to the property with a supplied index.
- `duk_put_prop_string` – Pop the value from the stack and set to the property with the supplied name.

Let us imagine that we want to create a new object with properties. We would do this by:

```
duk_idx_t objIdx = duk_push_object(ctx);
duk_push_string(ctx, "Hello world");
duk_put_prop_string(ctx, objIdx, "greeting");
```

The result will be a new object on the stack with the new property.

We can retrieve values from the stack with `duk_get_???` functions. These are non-destructive retrievals.

## Calling C from a JavaScript program

We can call native C function from a Duktape script. The functions must conform to the syntax:

```
duk_ret_t myFunction(duk_context *ctx) {
    return 0;
}
```

A return of 1 means the top of the stack is to be interpreted as a return value.

A return of 0 means that there is no return value and `undefined` is returned to the caller.

A negative value means an error and should map to `DUK_RET_???`.

To add a global function we would call:

```
duk_push_global_object(ctx); // Push the object into which we are going to set the
function.
duk_push_c_function(ctx, myFunction, argCount); // Push the function onto the stack.
duk_put_prop_string(ctx, -2, "<functionName>"); // Set the object at top-2 to have a
new function property.
```

## JerryScript

JerryScript is an open source implementation of JavaScript written exclusively in C with minimal footprint or requirements. It lends itself extremely well to running in embedded systems such as an ESP32.

Being open source, one wondered if it would be able to build as an ESP-IDF component and ... yes it does. A project is now under way to provide a distribution.

See also:

- [jerryscript.net](http://jerryscript.net)
- [JerryScript & IoT.js: JavaScript for IoT from Samsung](#)
- [JerryScript mailing list](#)
- [Zephyr OS](#)
- [IoT-JS](#)

## Platform specific files

When porting JerryScript to a new platform such as the ESP32, there are certain files that are environment specific. These can be found in the `<root>/targets` directory. The `default` directory has proven to work just fine. The functions that have to be implemented are:

- `jerry_port_fatal` – Handle an error from which JerryScript can't recover.
- `jerry_port_console` – Print to the console.
- `jerry_port_log` – Display or log diagnostics. The options levels are:
  - `JERRY_LOG_LEVEL_ERROR` –
  - `JERRY_LOG_LEVEL_WARNING` –
  - `JERRY_LOG_LEVEL_DEBUG` –
  - `JERRY_LOG_LEVEL_TRACE` –
- `jerry_port_get_time_zone` –
- `jerry_port_get_current_time` –

## JerryScript life-cycle

To run a JerryScript JavaScript program we go through a life cycle that starts with a call to `jerry_init()`. If we have a buffer that holds the JavaScript source, we then parse that source to create the environment suitable for execution. We do this by calling `jerry_parse()`. When we wish to run the code, we call `jerry_run()`. To cleanup we call `jerry_release_value()` against the parsed code and finally `jerry_cleanup()`.

To interpret code, we have an API call `jerry_eval()` which takes a string of JavaScript and interprets it in the current context. The return is the value of the evaluation which may indicate an error has occurred.

## Accessing the global environment

There is a special object that represents the full environment. We can obtain this through a call to `jerry_get_global_object()`.

## The `jerry_value_t`

The data type called `jerry_value_t` is the data type that references a JavaScript value. It can refer to:

- boolean
- number
- null
- object
- string
- undefined

We can create a `jerry_value_t` representing a string by creating one using a C NULL terminated string. For example:

```
jerry_value_t name = jerry_create_string((const jerry_char_t *)"John");
```

We can create a new object instance using `jerry_create_object()`. Given an object, we can set a property within that object using `jerry_set_property()`.

A `jerry_value_t` variable has a reference counter on it. Be sure and call `jerry_release_value()` when you no longer need a reference to it.

A value also has an error flag which can be checked with `jerry_value_has_error_flag()`.

## Handling errors

Errors encountered while parsing or running result in a `jerry_value_t` which has an error flag associated with it. We can check that error flag with a call to `jerry_value_has_error_flag()`. It is common that the resulting `jerry_value_t` corresponds to an object that has two properties:

- `name` – The identity (name) of the error ... for example "ReferenceError"
- `message` – An English description of the error.

The generation of error messages is optionally compiled in and is off by default. To compile JerryScript with error messages, add

```
-DJERRY_ENABLE_ERROR_MESSAGES
```

to the compilation.

## Interfacing JerryScript with C

From within a JavaScript program running in JerryScript, we can invoke a C function. This is a very important concept. It allows us to invoke arbitrary code such as ESP32 specific functions such as WiFi enablement.

The function that we wish to expose from C has to conform to a specific signature as defined by the `jerry_external_handler_t`.

```
jerry_value_t myHandler(  
    const jerry_value_t functionObj,  
    const jerry_value_t thisVal,  
    const jerry_value_t args[],  
    const jerry_length_t argsCount)
```

The `args` is an array of arguments passed in.

The `argsCount` is the number of arguments passed in.

We register the function with a call to `jerry_create_external_function()`.

```
jerry_value_t jerry_create_external_function(jerry_external_handler_t funcHandle)
```

Here is a full example:

```
static jerry_value_t testFunction(  
    const jerry_value_t functionObj,  
    const jerry_value_t thisVal,  
    const jerry_value_t args[],  
    const jerry_length_t argsCount) {  
  
    ESP_LOGI(tag, "testFunction called!");  
    return 0;  
}
```

```
{
    ...
    jerry_value_t testF = jerry_create_external_function(testFunction);
    jerry_value_t name = jerry_create_string((const jerry_char_t *) "f1");
    jerry_value_t global_object = jerry_get_global_object();
    jerry_set_property(global_object, name, testF);
    jerry_release_value(testF);
    jerry_release_value(name);
    jerry_release_value(global_object);
    ...
    // Now within the JavaScript we have a global function called f1() that
    // when it is called will invoke the C function called "testFunction".
}
```

## IoT.js

JavaScript is a powerful language but, like both C and Java, provides very little in the way of native libraries. The IoT.js project provides an environment with a rich set of pre-built objects and classes that you can use in your JavaScript applications.

See also:

- [IoT.js home page](#)

## Programming with Python

### Pycom Micropython

See also:

- [Github: pycom/pycom-micropython](#)
- [YouTube: MicroPython ESP32 Building and loading firmware with Tony D!](#)

## Programming with Lua

### Lua-RTOS for ESP32

See also:

- [Github: whitecatboard/Lua-RTOS-ESP32](#)



# Integration with Web Apps

## HTTP Protocol

The HTTP protocol is the underpinnings of all web based interactions including browser/web-server, REST requests and WebSockets.

## HTTP Headers

Following a HTTP request or response line, there will be zero or more HTTP headers. Think of these as name/value pairs that are used to pass additional information. Most HTTP headers are well document and architected into the standards while other headers can be used for application logic.

Some headers are common to both requests and responses while others are found only on requests or only on responses.

### Accept header

Used to indicate in a request the media types allowed in a response. The basic format is:

```
Accept: <type>/<subtype>
```

If we really don't care, we can specify the wildcards:

```
Accept: */*
```

However if we specify a type, we can wildcard the subtype:

```
Accept: text/*
```

or we can be explicit and define both type and subtype:

```
Accept: text/plain
```

Multiple entries can be supplied separated by commas. We can further qualify a type with a semicolon (";") followed by parameters.

### Authorization header

Provides authorization credentials. Remember that unless we are using transport level encryption, these authorization credentials will be visible in a network examination.

### Connection header

Used to indicate that the network connection should be closed by a request receiver after it has sent its response.

Connection: close

### Content-Length header

Used to indicate the size of the payload/content.

### Content-Type header

Used to indicate the type of data that is being sent in a request or response.

### Host header

The Host header is mandatory on an HTTP/1.1 request and identifies who the transmitted claims to be. For example:

Host: [www.example.org](http://www.example.org)

### User-Agent header

A header that identifies the originator of the request.

## **Web Servers**

A Web Server is a software component that listens for incoming HTTP requests from Web browsers. On receipt of a request, the web server sends a response. This can be the return of an HTML document for display in a browser or can be a payload of data that forms a service call response. An HTTP request can also include an incoming payload to send data into the ESP32 for processing. There are many implementations of Web Servers that can run within an ESP32 environment.

See also:

- [RFC7230 – HTTP/1.1 – Message Syntax and Routing](#)
- [HTTP: The Protocol Every Web Developer Must Know – Part 1](#)
- [Github: lighttpd](#) - nope
- [GNU Libmicrohttpd](#) - nope
- [LibHTTPD](#) - nope
- [Libonion](#) - nope
- [EmbedThis – GoAhead](#)
- [Monkey](#)

## Mongoose networking library

The Mongoose networking library provides a library implementation and associated API that one can use to build a rich and powerful HTTP server. If we think about the core nature of a web server, we will find that it passively listens on a TCP port waiting for incoming requests. When a request arrives it services that request and then returns to its listening state waiting for the next request to arrive. The request is a text stream encoded in the HTTP protocol. The way mongoose works is to provide a framework following this model. We can tell mongoose to start listening and then when a request arrives, an event handler (a subroutine of code that we are responsible for writing) is invoked. The parameters to the event handler include the nature of the event (there are different types) and a parsed representation of the incoming HTTP request. For example, when a request arrives to retrieve a web page, the mongoose framework will call our event handler and tell us the path to the page being requested. Our code can then send back an HTTP response containing the file. Whether we get that data from a "file" or generate it via a dynamic call in code is immaterial.

To use the framework, we call `mg_mgr_init()` to initialize the environment. Next we bind it to a handler using `mg_bind()`. Finally, we poll the server for work using

```
mg_mgr_poll().
```

```
void setupMongoose() {
    struct mg_mgr mgr;
    mg_mgr_init(&mgr, NULL);
    mg_bind(&mgr, ":80", evHandler);
    while(1) {
        mg_mgr_poll(&mgr, 1000);
    }
}
```

When a request arrives from a browser, we consider that an event which is handed off to an event handler. The signature of an event handler is:

```
void eventHandler(
    struct mg_connection *nc,
    int event,
    void *eventData)
```

Where:

- `nc` – The network connection that received the event.
- `event` – The type of event that triggered the callback.
- `eventData` – Data associated with the event.

Thus far we will receive callbacks for socket connections. If we wish, we can now register that we wish to parse the incoming data as an HTTP request. We do that by making a call to `mg_set_protocol_http_websocket()`. For example:

```
struct mg_connection *c = mg_bind(&mgr, ":80", mongoose_event_handler);
mg_set_protocol_http_websocket(c);
```

When setup as an HTTP server, an incoming browser request will appear with the event type of `MG_EV_HTTP_REQUEST`. The `eventData` passed in will be an instance of `struct http_message` from which the nature of the request can be determined.

Should we wish to setup debugging, we can compile with:

- `-DCS_ENABLE_DEBUG=1` – Specify if we want low level debugging.

`MG_EV` event types we might see include:

- `MG_EV_ACCEPT` – We have accepted a new connection.
- `MG_EV_RECV` – Data has been received. The `ev_data` is a point to an int describing how many bytes of data were received.
- `MG_EV_SEND`
- `MG_EV_CLOSE` – The connection has been close.
- `MG_EV_HTTP_REQUEST` – Data is an instance of a pointer to a "struct `http_message`".
- `MG_EV_HTTP_REPLY` – A response has been detected that is a response/reply to a previous HTTP request. Data is an instance of a pointer to a "struct `http_message`".

The `struct http_message` describes the nature of the message and contains:

- `message` – The whole incoming message. The type is a `struct mg_str`.
- `method` – The method sent with the request ... eg. "GET". The type is a `struct mg_str`.
- `uri` – The URI part of the request ... eg. "/hello". The type is a `struct mg_str`.
- `proto`
- `resp_code`
- `resp_status_msg`
- `query_string`
- `header_names` – An array of header names. The type is a `struct mg_str`.
- `header_values` – An array of header values. The type is a `struct mg_str`.

- `body` – The body of the incoming request. The type is a `struct mg_str`.

To send a response when we have received a request, we will start by calling `mg_send_head()`. This takes the status code, the length of the payload and any extra headers. To send the payload we will call `mg_send()`, `mg_printf()` or `mg_vprintf()`. Once all the data that we wish to send has been built, we should set the `nc.flags` value to include `MG_F_SEND_AND_CLOSE` to indicate that we have finished.

Note that some of the string data types are coded as the special type "`mg_str`" which is not the same as a null terminated string. Specifically, an `mg_str` is a C structure that contains two fields:

- `p` – A pointer to data.
- `len` – The length of the data.

We have some utility functions to work with instances of `mg_str` including:

- `struct mg_str mg_mk_str(const char *s)` – Make a new `mg_str` from a null terminated string.
- `struct mg_str mg_mk_str_n(const char *s, size_t len)` – Make a new `mg_str` from a pointer to data and length.
- `int mg_vcmp(const struct mg_str *str1, const char *str2)` – Compare an `mg_str` against a null terminated string.
- `struct mg_str mg_strdup(const struct mg_str s)` – Duplicate an `mg_str`.
- `struct mg_str mg_strcmp(const struct mg_str str1, const struct mg_str str2)` – Compare two `mg_str` instances.

To get a null terminated String from an `mg_str`, the following high level algorithm can be used:

```
char *mgStrToStr(struct mg_str mgStr) {
    char *str = (char *)malloc(mgStr.len + 1);
    memcpy(str, mgStr.p, mgStr.len);
    str[mgStr.len] = 0;
    return str;
}
```

Here is an example mongoose event handler that is used to return the time since ESP32 start-up when `/time` is the path request.

```
void mongoose_event_handler(struct mg_connection *nc, int event, void *eventData) {
    switch (event) {
        case MG_EV_HTTP_REQUEST:
            printf("HTTP REQUEST\n");
            struct http_message *message = (struct http_message *)eventData;
```

```

char *uri = mgStrToStr(message->uri);

if (strcmp(uri, "/time") == 0) {
    char payload[256];
    sprintf(payload, "Time since start: %d ms", system_get_time()/1000);
    int length = strlen(payload);
    mg_send_head(nc, 200, length, "Content-Type: text/plain");
    mg_printf(nc, "%s", payload);
}
else {
    mg_send_head(nc, 404, 0, "Content-Type: text/plain");
}
nc->flags |= MG_F_SEND_AND_CLOSE;
free(uri);
break;
}
}

```

The determination that the event is an HTTP request and the examination of the path is such a common occurrence that a helper function is provided called `mg_register_http_endpoint()`. This function registers a relative URI path and an event handler to be called when a request arrives that matches the path. This makes it easy for us to break out different paths.

Since the ESP32 uses co-routines to provide an illusion of parallelism, this then asks the question about whether we can make mongoose API calls from multiple tasks. The answer is no. Instead we must invoke `mg_broadcast()` to broadcast an event. The signature of `mg_broadcast` is:

```
mg_broadcast(struct mg_mgr *, mg_event_handler_t func, void *, size_t)
```

By default, this feature is disabled, to enable we have to add the following:

```
CFLAGS+==DMG_ENABLE_BROADCAST
```

See also:

- Github: [cesanta/mongoose](https://github.com/cesanta/mongoose)
- [Mongoose Developer Centre](#)
- Mongoose WebSocket

### Setting up Mongoose on an ESP32

The recipe I follow to setup Mongoose is as follows:

1. In your project directory, create a `components` directory.
2. In the `components` directory, clone Mongoose:

```
git clone https://github.com/cesanta/mongoose.git
```

3. In the new Mongoose directory, create a file called `component.mk` containing:

```
COMPONENT_ADD_INCLUDEDIRS=.
```

#### 4. Compile your solution.

As you see there isn't much to it; it just works.

### Sending a request from Mongoose

To send an HTTP request outbound from Mongoose we can use the `mg_connect_http()` API. This has the signature:

```
struct mg_connection *mg_connect_http(struct mg_mgr *mgr,
    mg_event_handler_t eventHandler,
    const char *url,
    const char *extraHeaders,
    const char *postData)
```

The `eventHandler` is a function that will be called to process events for this request.

### The Mongoose struct `mg_connection`

There are a number of fields/properties in the `struct mg_connection` that might be of use to use. Here is a list of some of the more important/interesting ones:

- `union socket_address sa` – The address and port number of the other end of the network connection. We can use the `mg_conn_addr_to_str()` function to convert the `mg_connection` into a printable string.

### Handling file uploads

To understand file uploads, we should start by thinking about an HTTP POST request with `multipart/form-data` encoding. In this scheme, the body of the HTTP POST contains multiple sections. Each section can contain a "name" attribute and the body of the section is the value of that attribute. For files, the section also contains an attribute called "filename" which is the simple name of the file that was supplied by the user.

If mongoose is compiled with the definition

```
MG_ENABLE_HTTP_STREAMING_MULTIPART
```

then additional events are presented during an incoming HTTP request. These events are:

- `MG_EV_HTTP_MULTIPART_REQUEST` – Indication of the start of a set of multipart form data sections.

- `MG_EV_HTTP_PART_BEGIN` – Indication that the start of a part is beginning.
- `MG_EV_HTTP_PART_DATA` – Data is being made available.
- `MG_EV_HTTP_PART_END` – The end of the part.
- `MG_EV_HTTP_MULTIPART_END` – Indication of the end of a set of multipart form data sections.

Associated with multi-part handling is the data structure called:

```
struct mg_http_multipart_part
```

This contains:

- `const char *file_name` – The name of the file.
- `const char *var_name` – The name of the variable.
- `struct mg_str data` – The data of the variable/file.
- `int status` – Status code.
- `void *user_data` – User taggable data.

A utility function is provided called `mg_file_upload_handler()`. This can be called when an `MG_EV_HTTP_PART_BEGIN`, `MG_EV_HTTP_PART_DATA` or `MG_EV_HTTP_PART_END` events are received. The signature of this function is:

```
void mg_file_upload_handle(
    struct mg_connection *nc,
    int ev,
    void *ev_data,
    mg_fu_fname_fn local_name_fn)
```

The `local_name` parameter is a function reference to a function with the signature:

```
struct mg_str upload_fname(struct mg_connection *nc, struct mg_str fname)
```

This function is responsible for determining the name of the file to be created.

## GoAhead Web Server

The high level structure of GoAhead is:

See also:

- [The EmbedThis GoAhead Web Server](#)



## JavaScript Webservice

Running JavaScript on the ESP32 opens up some elegant techniques to serve web pages. Using JavaScript for web servers is discussed in the JavaScript section and not repeated here.

See also:

- [ESP32 Technical Tutorials: ESP32 Duktape WebServer](#)

## REST Services

The notion of distributed computing dates back many decades. The idea that one computer could perform a service on behalf of another is a classic concept. The thinking is that work could be distributed across systems, data could be centralized or dedicated systems could perform specialized roles. Over the years, many forms of distributed computing have been tried. These include socket servers, remote procedure calls (RPC), Systems Network Architecture (SNA), Distributed Computing Environment (DCE), Web Services and others.

Today (2017), the current incumbent of distributed computing protocols and technology is REST. REST is a simple protocol that leverages the existing Hyper Text Transport Protocol (HTTP) used as the transport between browsers and web servers. This protocol was built to allow a browser to request data from a remote file system hosted by a web server. It provides HTTP "commands" which include GET, POST, PUT and others. The notion behind REST is more of an accident than a design. REST re-purposes HTTP as a communication conduit from a client to a server where a client makes a REST request and the server offers up a REST service. From the network perspective, it "looks" just like a browser/Web Server interaction but both ends choose to agree on the formation and interpretation of the communication.

When we add an ESP32 into the mix, our desire is two-fold. We want the ESP32 to be able to be a client to external REST service providers and we want the ESP32 to be the target of clients making REST requests. From the partner perspective, it should be unaware that it is interacting with the ESP32 as compared to any other computing device.

## REST protocol

The REST protocol is built on top of HTTP.

See also:

- [RFC7230 – HTTP/1.1 – Message Syntax and Routing](#)
- [HTTP: The Protocol Every Web Developer Must Know – Part 1](#)

## ESP32 as a REST client

For the ESP32 to be a REST client, it must build and transmit HTTP requests to the service provider. This will include building HTTP headers, transmitting the data in a form expected by the provider (eg. JSON, XML or other textual representation) and handling the response from the provider which may include interpreting the received payload.

To transmit a REST request is composed of two parts. First it opens a TCP connection to the partner and then transmits the HTTP compliant data down that connection. The first part is easy, the second part is more of a challenge. We could read and understand the HTTP spec and build the request part by part but this would have to be done for each project that wishes to use REST client technology. What would be better is if we had a library that "knows" how to make well formed REST requests and we simply leveraged its existing functions.

### Making a REST request using Curl

Not only is curl a command line tool, it is also a very rich library of function that can be used in your own projects. From an architectural perspective, any app that wants to use curl as a library should perform an initialization call, request an opaque "handle", setup parameters on the handle and then perform the request against the handle. The handle is a black-box that encapsulates the nature of the request. It hides from us all the low level details and gives us a higher level abstraction against which we can think of working with network endpoints.

At a high level we call `curl_global_init()` for coarse initialization. Next we get a handle using `curl_easy_init()`. When we are finished with the handle we should call `curl_easy_cleanup()` to dispose of it and release any resources that may have been allocated on its behalf. The handle is the container that is used to associate options. We set options against a handle using `curl_easy_setopt()`. We will use this function to set the target URL at a minimum.

We can define a callback function that is invoked when data is received upon the handle. That callback function is registered against the handle. The signature of the callback function looks like:

```
size_t writeData(void *buffer, size_t size, size_t nmemb, void *userp)
```

Think of this function as receiving a buffer of records where each record is of size bytes and the number of records is `nmemb`. Typically, `size` will be 1 and `nmemb` will then be the

total size of data in the buffer. The function should return the size of data consumed. If it is not `size * nmemb` then that will stop processing.

Once written, we can register the callback with:

```
curl_easy_setopt(handle, CURLOPT_WRITEFUNCTION, writeData);
```

Notice that the data callback has a parameter at the end called `userp`. This is a pointer to context data that relates the request to the response. The value passed in to the callback function is the value registered with the handle using the `CURLOPT_WRITEDATA` parameter:

```
curl_easy_setopt(handle, CURLOPT_WRITEDATA, dataPointer);
```

When ready, we can ask the handle to perform its task using:

```
success = curl_easy_perform(handle);
```

It is common that we want to pass HTTP headers with our request. To do this we build a list where each entry in the list is a name/value header entry. We use the data type `struct curl_slist` to hold the list:

```
struct curl_slist *headers = NULL;
```

To add a header we can then use:

```
headers = curl_slist_append(headers, "Content-Type: application/json");
```

To associate the headers with a handle, we call:

```
curl_easy_setopt(handle, CURLOPT_HTTPHEADER, headers);
```

When the list has served its purpose, we can release the resources used to manage the list with a call:

```
curl_slist_free_all(headers);
```

When making a REST request, we commonly wish to set the command in the HTTP payload. We can use the following to set different styles:

To set the command to GET, use:

```
curl_easy_setopt(handle, CURLOPT_HTTPGET, 1);
```

To set the command to POST, use:

```
curl_easy_setopt(handle, CURLOPT_POST, 1);
```

To set the command to PUT, use:

```
curl_easy_setopt(handle, CURLOPT_PUT, 1);
```

These commands will set the Content-Type to the form format. If we wish to send data as-is, don't call either of the above but just specify `CURLOPT_POSTFIELDS` data by itself.

To send data with the request, we can use:

```
curl_easy_setopt(handle, CURLOPT_POSTFIELDS, data);
```

Where the data is a null terminated string.

The Curl package has a number of great samples. Here is a good instance that makes an HTTP GET request.

```
#include <stdio.h>
#include <curl/curl.h>

int main(void)
{
    CURL *curl;
    CURLcode res;

    curl = curl_easy_init();
    if(curl) {
        curl_easy_setopt(curl, CURLOPT_URL, "http://example.com");
        /* example.com is redirected, so we tell libcurl to follow redirection */
        curl_easy_setopt(curl, CURLOPT_FOLLOWLOCATION, 1L);

        /* Perform the request, res will get the return code */
        res = curl_easy_perform(curl);
        /* Check for errors */
        if(res != CURLE_OK)
            fprintf(stderr, "curl_easy_perform() failed: %s\n",
                    curl_easy_strerror(res));

        /* always cleanup */
        curl_easy_cleanup(curl);
    }
    return 0;
}
```

An excellent resource for testing Curl requests is the "httpbin.org" website. This provides HTTP rest responses for a variety of tests.

To build libcurl we create a components directory and perform some commands within.

The curl source can be downloaded from github using:

```
$ git clone https://github.com/curl/curl.git
```

Next we run:

```
$ ./buildconf
```

```
$ ./configure
```

Remove the following from lib/curl\_config.h

```
HAVE_LIBSSL
```

USE\_OPENSSL  
HAVE\_ZLIB  
HAVE\_LIBZ  
HAVE\_SIGSETJMP  
HAVE\_SYS\_POLL  
HAVE\_POLL  
HAVE\_POLL\_H  
HAVE\_CLOCK\_GETTIME\_MONOTONIC  
HAVE\_NET\_IF\_H  
HAVE\_SYS\_IOCTL\_H  
HAVE\_SYS\_SELECT\_H  
HAVE\_SYS\_UN\_H  
HAVE\_NETINET\_TCP\_H  
HAVE\_MSG\_NOSIGNAL  
HAVE\_POLL\_FINE  
USE\_UNIX\_SOCKETS  
HAVE\_IFADDRS\_H  
HAVE\_STROPTS\_H  
HAVE\_GETIFADDRS  
HAVE\_IOCTL\_SIOCGIFADDR  
HAVE\_GETHOSTNAME  
HAVE\_GETEUID  
HAVE\_BASENAME  
HAVE\_SIGNAL

When building curl, we may need to set some definitions:

The following can be found `include/curl/curlbuild.h`:

- `CURL_SIZEOF_LONG - 4` – The size in bytes of a long.

- `CURL_TYPEOF_CURL_SOCKLEN_T` – unsigned int – The data type that is a `socklen_t`.
- `CURL_TYPEOF_CURL_OFF_T` – long
- `CURL_FORMAT_CURL_OFF_T` – "ld"
- `CURL_FORMAT_CURL_OFF_TU` – "lu"
- `CURL_FORMAT_OFF_T` – "%ld"
- `CURL_SIZEOF_CURL_OFF_T` – 4
- `CURL_SUFFIX_CURL_OFF_T` – L
- `CURL_SUFFIX_CURL_OFF_TU` – UL

We also need a `lib/curl_config.h`

We will also need a `component.mk` with the following entries:

```
COMPONENT_SRCDIRS:=lib
COMPONENT_PRIV_INCLUDEDIR:=lib include
include $(IDF_PATH)/make/component_common.mk
```

We need to say that we don't have includes:

- `netinet/in.h` – `HAVE_NETINET_IN_H`
- `arpa/inet.h` – `HAVE_ARPA_INET_H`
- `net/if.h` – `HAVE_NET_IF_H`
- `sys/ioctl.h` – `HAVE_SYS_IOCTL_H`
- `process.h` – `HAVE_PROCESS_H`
- `fcntl.h` – `HAVE_FCNTL_H`
- `netinet/tcp.h` – `HAVE_NETINET_TCP_H`

To enable SSL, we add:

```
#define USE_MBEDTLS 1
```

And in the `CFLAGS+=-DMBEDTLS_FS_IO` to both the CURL and the MBEDTLS component.

See also:

- [Curl](#)
- [Curl C API](#)
- [curl\\_easy\\_setopt](#)
- [libcurl examples](#)

### Making a REST request using Mongoose

Using the Mongoose APIs, we can quite easily send a REST request and work with the response. The high level story is to initialize Mongoose with `mg_mgr_init()`, request a connection to the REST service provider with `mg_connect()`, associate the connection as being HTTP oriented and then start processing events. The first event to return will be an `MG_EV_CONNECT` event indicating that we are now network connected. From there we can use `mg_printf()` to send the REST request. When the REST partner responds, we will get an `MG_EV_HTTP_REPLY` event and we have completed our request/response pairing.

### **ESP32 as a REST service provider**

For an ESP32 to be a REST service provider, basically means that it has to play the role of a Web Server and respond to Web Server requests. However, unlike a simple Web Server which simply retrieves and sends file content as a function of the path on the URL, it is likely that the REST service provider will perform some computation when an HTTP client request arrives. For example, if we attached a temperature sensor to the GPIOs of the ESP32, when a REST request arrives, the ESP32 could read the current temperature value and send the encoded result back as a the response to the request.

Being a Web Server basically means listening on a TCP port and when connections arrive, interpreting the data received as HTTP protocol. This would be a lot of work on a project by project basis but thankfully there are a number of pre-written libraries that perform this task for us and all we need concern ourselves with is examination of any parameters passed with the request and performing the logic we wish performed when ever a new request is received.

Once again, mongoose becomes an excellent consideration for being a Web Server and handling incoming requests.

See also:

- [Mongoose networking library](#)

### **WebSockets**

WebSockets is both an API and a protocol introduced in HTML5. Simply put, if we imagine an HTTP server sitting waiting for incoming HTTP requests, we can convert a current request into a socket connection between the server and the browser such that either end can send data to be received by its partner.

Here we see a raw request to upgrade an HTTP connection to a WebSocket connection:

```
GET / HTTP/1.1
Host: 192.168.1.10
Connection: Upgrade
Pragma: no-cache
Cache-Control: no-cache
Upgrade: websocket
Origin: file://
Sec-WebSocket-Version: 13
User-Agent: Mozilla/5.0 (X11; Linux x86_64) AppleWebKit/537.36 (KHTML, like Gecko)
Chrome/46.0.2490.86 Safari/537.36
Accept-Encoding: gzip, deflate, sdch
Accept-Language: en-US,en;q=0.8
Sec-WebSocket-Key: saim6TzFH+zVb4qY2nrh0Q==
Sec-WebSocket-Extensions: permessage-deflate; client_max_window_bits
```

See also:

- [html5rocks – Introducing WebSockets: Bringing Sockets to the Web](#)
- [The WebSocket protocol – RFC6455](#)
- [The WebSocket API](#)

## A WebSocket browser app

The highest likelihood is that you will be running your ESP32 as a WebSocket server. This would imply that you are going to have browser hosted applications that will be connecting to a WebSocket server as clients and from there, you will likely be writing some WebSocket client code ... if nothing else then for unit testing your server. Because of that, we will now spend some time talking about what is involved in writing a WebSocket client application.

Let us assume that we will be writing JavaScript hosted in the browser. We start by creating an instance of a WebSocket object passing in the URL to the WebSocket server:

```
var ws = new WebSocket("ws://<somehost>[:<someport>]");
```

The WebSocket API is mostly event driven and there are a number event types of interest to us:

- `open` – Invoked when the connection to the WebSocket server has been established and we are now ready to send or receive data. We can define this with the `"onopen"` property of the WebSocket as a function reference.



- `message` – Receive a message from the server. We can define this with the `"onmessage"` property of the `WebSocket` as a function reference. The incoming message data passed to the handler function contains a `MessageEvent` which contains:
  - `data` – The payload of the message.
- `error` – Receive an indication that an error was detected. We can define this with the `"onerror"` property of the `WebSocket` as a function reference.
- `close` – Receive an indication that a request to close the connection was detected. We can define this with the `"onclose"` property of the `WebSocket` as a function reference.

Event handlers can be registered either with an `"on<Event>"` mechanism or with an `addEventListener()` call.

There are two methods defined on a `WebSocket` object. Those are:

- `send` – Send data to a `WebSocket` server. The signatures are:
  - `send(String)`
  - `send(Blob)`
  - `send(ArrayBuffer)`
  - `send(ArrayBufferView)`
- `close` – Close the connection to a `WebSocket` server. The `close()` method takes two parameters:
  - `close code` – An integer close code describing the reason for the close.
    - `1000` – `CLOSE_NORMAL`
    - `1001` – `CLOSE_GOING_AWAY`
  - `status message` – A string describing the close reason.

Finally, there are a few attributes:

- `readyState` – The state of the `WebSocket` connection. Values include:
  - `WebSocket.CONNECTING`
  - `WebSocket.OPEN`
  - `WebSocket.CLOSING`
  - `WebSocket.CLOSED`

- `bufferedAmount` – Amount of data that is buffered pending transmission to the WebSocket server
- `protocol` – The WebSocket server selected protocol being used.

## Mongoose WebSocket

Using Cesanta's Mongoose libraries, we can setup a WebSocket server. After setting up a binding for incoming network requests we can call

`mg_set_protocol_http_websocket()`. This will attach an event handler to the network protocol level to handle events associated with WebSockets. Specifically, these are the following web socket events we are interested in:

- `MG_EV_WEBSOCKET_HANDSHAKE_REQUEST` –
- `MG_EV_WEBSOCKET_HANDSHAKE_DONE` –
- `MG_EV_WEBSOCKET_FRAME` –

When an `MG_EV_WEBSOCKET_HANDSHAKE_REQUEST` is received, the data contains a parsed HTTP request as a `struct http_message`. When we receive the `MG_EV_WEBSOCKET_HANDSHAKE_DONE` event, we are ready to send and receive web socket messages.

When an `MG_EV_WEBSOCKET_FRAME` is received, the data contains a reference to a `struct websocket_message`. The `struct websocket_message` contains:

- `data` – The data passed from the partner.
- `size` – The size of the passed data.
- `flags` – Flags (unknown).

To send outbound (out from Mongoose) web socket messages we use the `mg_send_websocket_frame()` API call. The signature of this function is:

```
void mg_send_websocket_frame(
    struct mg_connection *nc,
    int op_and_flags,
    const void * data,
    size_t data_len)
```

The `op_and_flags` should be one of:

- `WEBSOCKET_OP_CONTINUE`
- `WEBSOCKET_OP_TEXT`
- `WEBSOCKET_OP_BINARY`
- `WEBSOCKET_OP_CLOSE`

- WEBSOCKET\_OP\_PING
- WEBSOCKET\_OP\_PONG
- WEBSOCKET\_DONT\_FIN – This can be boolean or'd with one of the above to indicate that we will be continuing.

For example, if we wish to send a "Hello World" message we might code:

```
char *message = "Hello World";  
mg_send_websocket_frame(nc, WEBSOCKET_OP_TEXT, message, strlen(message));
```

See also:

- [Mongoose networking library](#)

## Other Websocket implementations

See also:

- [WebSockets on the ESP32](#)

## Tasker

Tasker is an Android application that automates and scripts tasks to be executed on an Android device. Using Tasker we can create a task which is defined as a sequence of commands and actions to be executed. Next we can create a Profile which maps an event, that when detected, executes a task. Although this is useful, how does that relate to an ESP32? Imagine that the event that occurs is an ESP32 sending a message to your phone. With that notion, an ESP32 can, effectively, trigger anything that one might be able to do with such a phone. For example, it might make a phone call, send an SMS message or capture a photograph.

See also:

- [Tasker home page](#)
- YouTube: [Tasker 101 Tutorials](#)

## AutoRemote

Following on from our discussion of Tasker above, we now have an admission. It appears that Tasker does **not** have the ability to listen for incoming TCP/IP based events and messages. However, because Tasker is extensible and developers can write plug-ins for it, Tasker can be augmented. One such augmentation is the AutoRemote plugin. Using that plugin, a TCP/IP message can then be sent and received by AutoRemote which can then act as a source of events for Tasker.

With AutoRemote configured as a Tasker plugin, we can configure it to listen for HTTP requests. This causes AutoRemote to listen on TCP port number 1817. The data it is listening for is an HTTP request. For example:

```
http://<phone ip>:1817/sendmessage?message=1
```

With both Tasker and AutoRemote installed, it will still not be listening for incoming WiFi messages over a local WiFi environment unless we are Internet connected. We must run a Tasker Task called "AutoRemote WiFi".

For example, in Tasker:

1. Create a new profile triggered by Event → System → Device Boot
2. Create a New Task associated with the profile
3. Add an action from Plugin → AutoRemote → Wifi
4. In the configuration for the action, check "Wifi Service"

What this will do is start the Wifi Service whenever the device (Android) boots.

Unfortunately, AutoRemote has a serious drawback. It doesn't allow Tasker to send a response back in the original REST request that might contain data that could be used. For example, if we wish to use AutoRemote to send a request that returned the current GPS location, that is simply not possible.

When an AutoRemote request arrives, it sets a number of variables within the Tasker environment that can be used as parameters to Tasker tasks. These include:

- %armessage
- %arpar()
- %arcomm
- %artime
- %arfiles
- %arsenderbtmac
- %arsenderid
- %arsenderlocalip
- %arsendername
- %arsenderpublicip
- %arsendertype
- %arvia
  - wifi

See also:

- [AutoRemote home page](#)

## DuckDNS

I anticipate that in most folks houses there is a WiFi access point that either directly or through a modem, connects to the Internet. Since the WiFi access point offers a local network to which the ESP32 can join, we now see that the ESP32 can reach the outside world through the access point. However, what about the reverse? What if we want a client on the Internet to reach our ESP32. How could we achieve that?

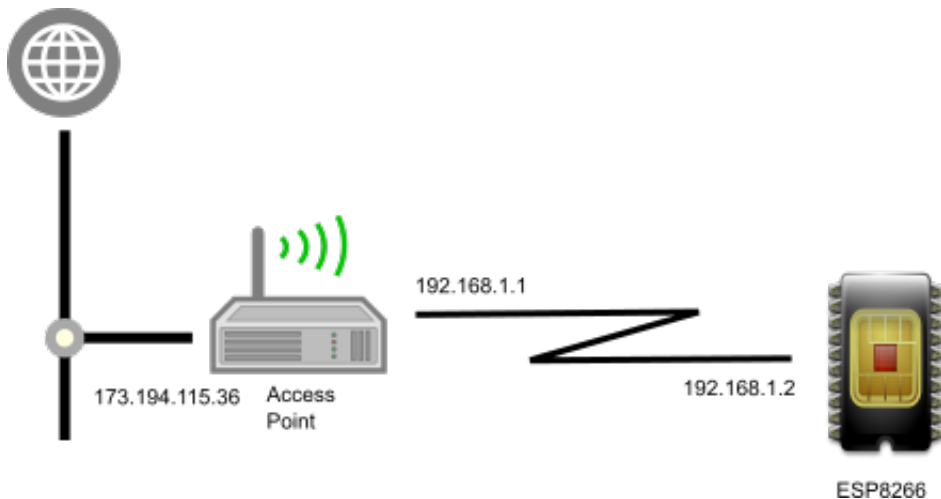

If we look at the above diagram (all IP address made up), we see that the ESP32 knows its own IP address as 192.168.1.2. However, this can't be "shared" with the Internet as that is a local address and not a global IP address. What would need to be shared is the IP address of the access point as seen on the Internet.

One way to achieve that is through the use of a service provider such as DuckDNS. This free service allows you to register a name. Your device (usually a PC) periodically sends a request to the DuckDNS web site saying "Hello ... I am here!". The return address implicitly sent with the request is always the IP address of your access point connected to the Internet and hence DuckDNS learns your external address. Later, someone (perhaps a third party) can ask "What is the IP address" of the name you registered and that address is made available. Essentially, DuckDNS acts as a real-time broker of logical names to IP addresses.

If you are concerned that "some scary person" can learn the IP address of your access point ... then don't use DuckDNS. However, for the majority of us, our modem/router/access point prevents incoming traffic from reaching us and essentially

blocks anything we don't want. But wait ... won't this also block requests to the ESP32? The answer is "yes it will" which is why you have to define port-forwarding. Port forwarding a function of your modem/router/access point that says that when a request arrives for a given port location, automatically forward it to an IP address on your local network ... for example, the network address of your ESP32.

<https://www.duckdns.org/update?domains=XXX&token=XXX&ip=>

## Networking protocols

### MQTT

The MQ Telemetry Transport (MQTT) is a protocol for publish and subscribe style messaging. It was originally invented by IBM as part of the MQSeries family of products but since has become an industry standard governed by the Oasis standards group. The latest specification version is 3.1.1.

Being Pub/Sub, this means that there is a broker (an MQTT Broker) to which subscribers can register their subscriptions and publishers can submit their publications. Publications and subscriptions agree on the topics to be used to link the messages together. A client can be a publisher, a subscriber or both.

The value of MQTT is that it can be used to deliver data from an application running on one machine to an application running on another. Immediately we seem to see an overlap between MQTT and REST calls but there are some major differences. In a REST environment, when you form a connection from a client to a server, the server must be available in order for the client to deliver the data. With MQTT that is not necessarily the case. The client can publish a message which can then be held by the broker until such time as the receiving application comes on-line to retrieve it. This is a store and forward mechanism.

Every published message must have a topic associated with it that is used to determine which subscribers would be interested in receiving a copy.

The structure of a topic is broken into topic levels separated by a "/". Subscribers can include wild cards in their topic selections of copies of messages that they would like to receive:

- + – Single topic level wild-card

eg. a/+ /c

would subscribe to a/b/c and a/x/c.

- # – Multi topic level wild-card

eg. a/#

would subscribe to a/<anything>.

MQTT is commonly implemented on top of TCP/IP. Clients connect to the broker (not to each other) over a TCP connection.

There is a quality of service requested by a client. This is encoded in the QoS field:

- QoS=0 – Deliver at most once. This can lose messages. At most once means perhaps never.
- QoS=1 – Deliver at least once. This means that the message will be delivered. Saying this another way, a message will not be discarded or lost. However, duplicates can arrive ... i.e. the message can be delivered twice or more.
- QoS=2 – Deliver exactly once. This means that the message will not be lost and will be delivered once and once only.

MQTT also has the capability to buffer messages for subsequent delivery. For example, if a client subscriber is not currently connected, a message can be queued or stored for delivery to the client when it eventually re-connects. We call a client that is not connected an off-line client. For a subscription, we have the choice to deliver all the queued messages for a client or just the last message. In MQTT parlance, this last message is called the *retained* message. To understand the difference, we can imagine a published message that says "I sold your stock for <\$\$\$> price" ... we want all such messages sent to the client because they are all of interest. However if we think of a published message of "Today's forecast is sunny and warm" then there may be no need for old messages and only the current weather forecast is of interest to us. During publishing we can declare that a message is eligible for retention and this is called the "retained message". When a client subscribes, it can ask to receive the last retained message immediately ... so even if a subscription takes place after a previous publication, it can still receive data immediately.

Clients make their status known to the broker so the broker can tell if a client is connected. This is achieved via a keep-alive/heartbeat. When forming a connection to a broker, the client provides a keep-alive interval (in seconds). If the broker hasn't received a message from the client in this interval then the broker can disconnect the client assuming it to have been lost/disconnected. If the keep-alive interval is set to 0, then there will be no validation from the broker. For keep alive to work, the client must communicate with the server periodically. We should assume at least once during a keep-alive interval duration. The client can send a ping request which confirms its liveness.

If a client connection is lost because of a network disconnection, the broker can detect that occurrence. This is where we get morbid. We define this as the client having "died". In the real world, when someone dies, there may be a last "will and testament" which are the desired instructions of what the person wanted to happen when they die. MQTT has a similar concept. A client can register a message to be published in the event of the clients death. This is remembered by the broker and in the event of the client connection ending, the broker will perform the role of the attorney and publish the last registered "will and testament" message on behalf of the deceased client.

When a client connects to a server, it is the responsibility of the client to present a client identifier. This is the identification that should be unique to the client and is used to allow the server to recognize the client as that particular client. When a connection is achieved between a client and a server, we say that a session has been formed between them. When the client requests a subscription, that subscription is associated with the session. When the client disconnects from the server, that *could* be the end of the session and hence the subscriptions associated with it. However, we have the opportunity for the session state (hence the set of subscriptions) to be maintained between connections. In this manner, a client can connect and provides its client identifier. This can cause the creation of a new session. If the client now perform subscription requests, these are associated with the session. When the client disconnects, the logical session can be remembered and when messages are published by other clients for the topic in question, the server can remember that there are sessions that exist that want those messages. When the original client re-connects and presents the original client identity, the session is resumed and the saved messages delivered. When a client connects it can request a *clean session*. This causes the server to *forget* the previous session and start a new one. All subscriptions associated with the old session are discarded as are any messages that may have been held for that session for subsequent delivery.

The default port number for an MQTT broker is 1883 for non TLS traffic and 8883 for TLS traffic.

See also:

MQTT Hive

Mosquitto

- ESP MQTT
- [MQTT.org](#)
- [Mosquitto.org](#)
- YouTube: [Internet of Things – Why You Need MQTT](#)
- [OASIS Message Queuing Telemetry Transport \(MQTT\)](#)
- [OASIS MQTT V3.1.1 Specification](#)



## Mosquitto MQTT

One of the most prevalent implementations of MQTT is called `Mosquitto` and is available as an open source implementation. On a Linux system we would install with:

```
$ sudo apt-get install mosquitto
```

Where `systemd` is installed, `mosquitto` is controlled by it. To see if it is running execute

```
$ systemctl status mosquitto
```

```
• mosquitto.service - LSB: mosquitto MQTT v3.1 message broker
  Loaded: loaded (/etc/init.d/mosquitto)
  Active: active (running) since Thu 2016-01-21 21:32:26 CST; 6min ago
  Docs: man:systemd-sysv-generator(8)
  CGroup: /system.slice/mosquitto.service
          └─12871 /usr/sbin/mosquitto -c /etc/mosquitto/mosquitto.conf
```

```
Jan 21 21:32:26 kolban-VirtualBox systemd[1]: Starting LSB: mosquitto MQTT v3.1
message broker...
Jan 21 21:32:26 kolban-VirtualBox mosquitto[12862]: * Starting network daemon:
mosquitto
Jan 21 21:32:26 kolban-VirtualBox mosquitto[12862]: ...done.
Jan 21 21:32:26 kolban-VirtualBox systemd[1]: Started LSB: mosquitto MQTT v3.1 message
broker.
```

The default configuration file for `mosquitto` is `/etc/mosquitto/mosquitto.conf`.

Messages from `mosquitto` are logged to `/var/log/mosquitto/mosquitto.log`.

Two sample applications are provided that perform subscriptions and publications. These are `mosquitto_sub` and `mosquitto_pub`. These are distributed as part of the `mosquitto-clients` package.

As a simple test, open two terminal sessions. In one run:

```
$ mosquitto_sub -t greeting
```

When the subscriber is started it will sit quietly waiting for an arriving publication.

In the other run:

```
$ mosquitto_pub -t greeting -m "Hello World"
```

Some other common flags we use with this command include:

- `-r` – Mark this publication as "retained".
- `-q 0|1|2` – Set the Quality Of Service of the message.
- `-d` – Include debugging in the output.
- `-h` – Host (server) to connect to. Defaults to localhost.
- `-p` – Port number to connect to. Defaults to 1883.

You will see the published message appear in the subscriber window.

Let us now dig a little further into a `mosquitto` configuration file. Within there, we can specify multiple "listener" entries. These can bind to a port or a port and interface. Within a listener section, we can configure the protocol that the listener should use. By default, it will be plain TCP for normal client connections but we can specify that the protocol should be "websockets". For example, adding the following into the `mosquitto.conf` file:

```
listener 8081
protocol websockets
```

will cause `mosquitto` to listen for websocket clients on port 8081. If you want to listen on **both** standard mqtt protocol and websocket, then you will need multiple listener definitions.

```
listener 1883
protocol mqtt
```

```
listener 8081
protocol websockets
```

See also:

- [Mosquitto.org](http://mosquitto.org)
- [man\(1\) – mosquitto\\_sub](#)
- [man\(1\) – mosquitto\\_pub](#)
- [man\(5\) – mosquitto.conf](#)
- [MQTT Community Wiki](#)

### Installing on Windows

We can download and install a version of Mosquitto for Windows. Binary downloads are available here:

<http://mosquitto.org/download/>

The version illustrated here is 1.4.8.

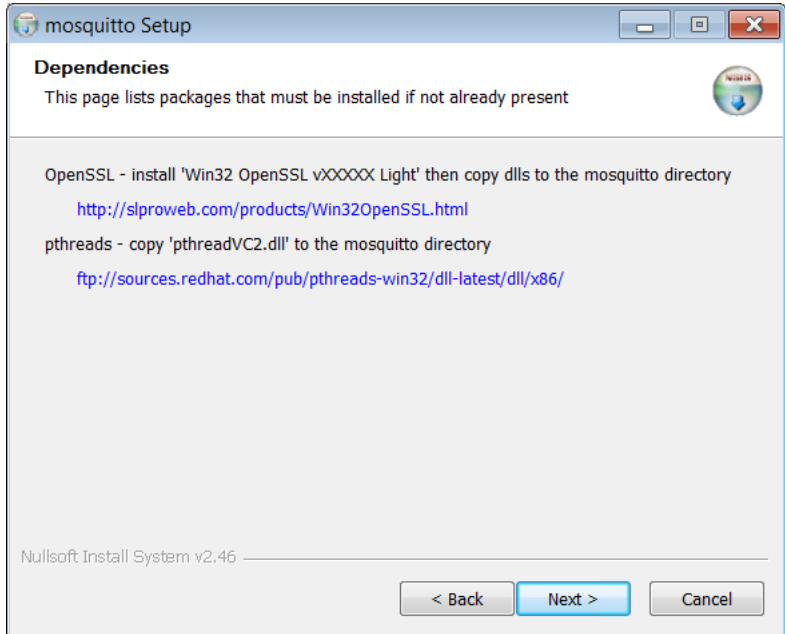
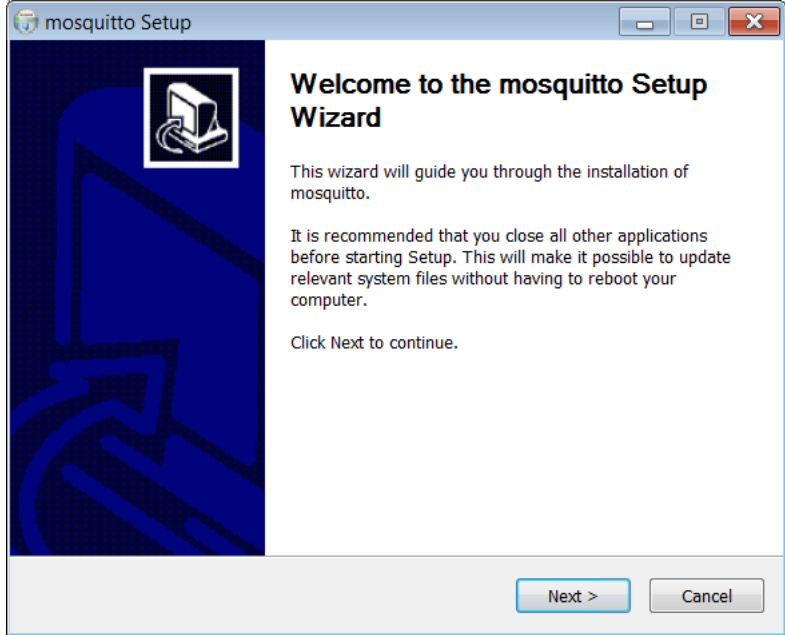

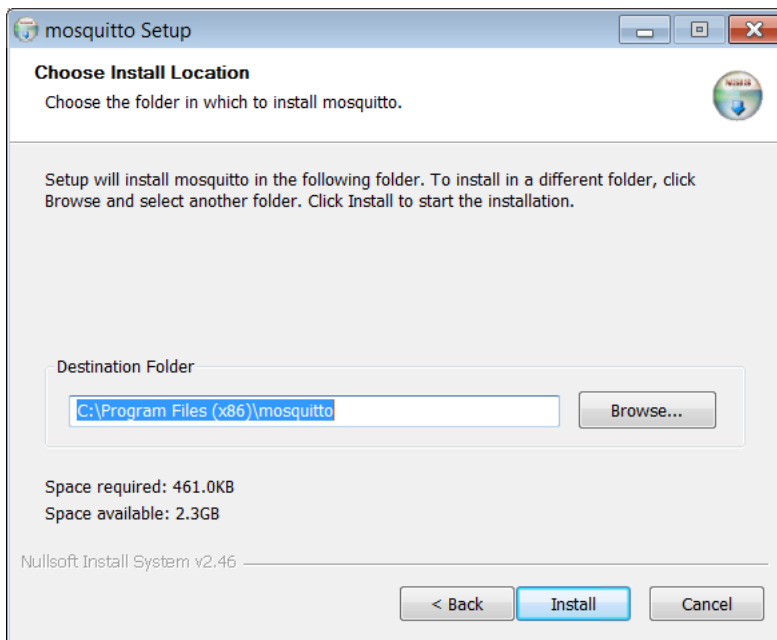
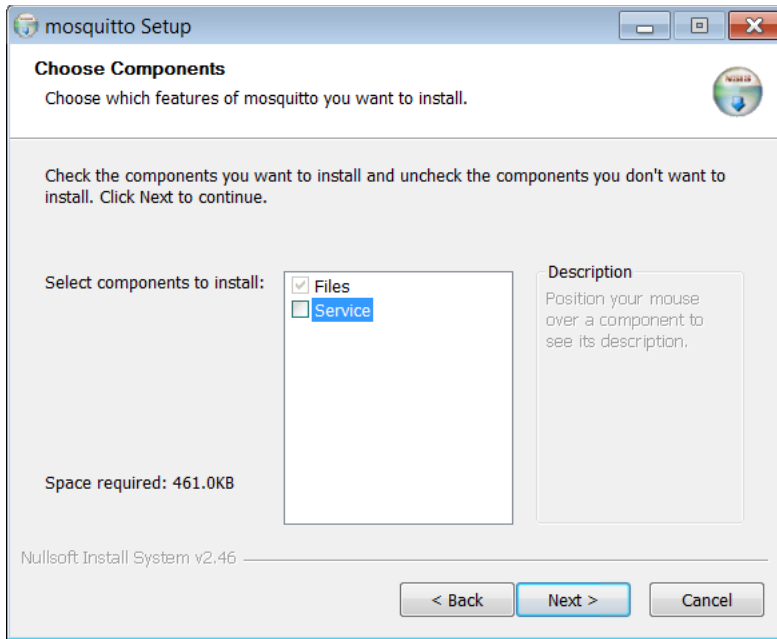

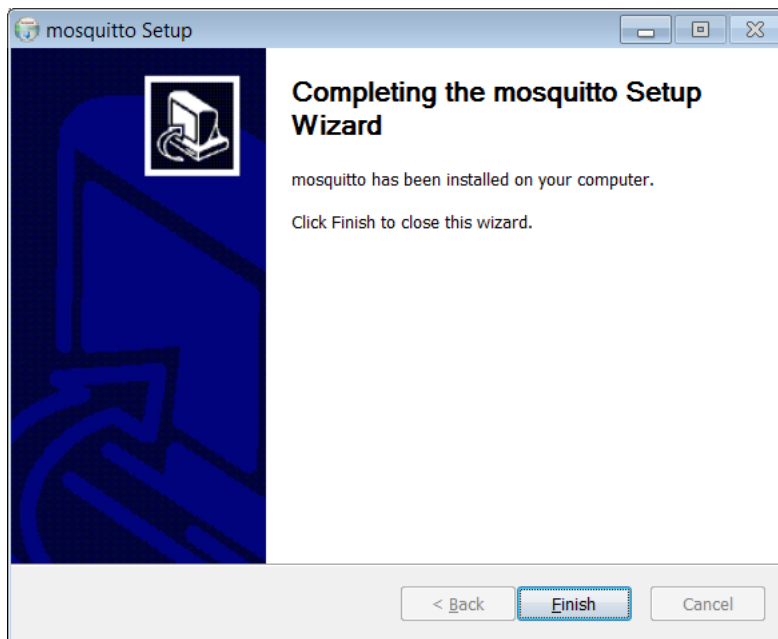

## Writing ESP32 MQTT clients

### Using Mongoose as an MQTT client

Once again we can turn to Mongoose to provide higher level networking services. Not only can Mongoose be a Web Server and provide HTTP calling services, it also provide MQTT services.

To be a client, at a high level we perform the following operations:

```
mg_mgr_init(...);
mg_connect(...);
while(1) {
    mg_mgr_poll(...);
}
```

In the event handler we registered in `mg_connect()`, we process events as follows:

### MG\_EV\_CONNECT

```
mg_set_protocol_mqtt(...);
mg_send_mqtt_handshake_opt(...);
```

### MG\_EV\_MQTT\_CONNACK

```
// Do something now we are MQTT broker connected ...
```

To publish a message we can call `mg_mqtt_publish()`.

To subscribe, we can call `mg_mqtt_subscribe()`. The signature for a subscription is:

```
void mg_mqtt_subscribe(  
    struct mg_connection *nc,  
    const struct mg_mqtt_topic_expression *topics,  
    size_t topicsLen,  
    uint16_t messageId)
```

The `mg_mqtt_topic_expression` is a structure that contains two fields:

- `topic` – `char *` – The identity of the topic on which to subscribe.
- `qos` – `uint8_t` – The quality of service.

Following a subscription, when a publication arrives, we will receive the `MG_EV_MQTT_PUBLISH` event. The payload of the event is an instance of an `mg_mqtt_message` which contains:

Type	Name	Notes
<code>int</code>	<code>cmd</code>	
<code>struct mg_str</code>	<code>payload</code>	The payload of a received message.
<code>uint8_t</code>	<code>connack_ret_code</code>	Used on <code>MG_EV_MQTT_CONNACK</code> .
<code>uint16_t</code>	<code>message_id</code>	Used on <code>MG_EV_MQTT_PUBLISH</code> .
<code>char*</code>	<code>topic</code>	The topic on which the message was received.

Here is a concrete example:

```
void event_handler_mqtt(struct mg_connection *nc, int ev, void *evData) {  
    switch (ev) {  
        case MG_EV_CONNECT:  
            mg_set_protocol_mqtt(nc);  
            mg_send_mqtt_handshake(nc, "dummy");  
            break;  
        case MG_EV_MQTT_CONNACK: {  
            struct mg_mqtt_message *msg = (struct mg_mqtt_message *) evData;  
            if (msg->connack_ret_code == 0) {  
                mg_mqtt_publish(nc, "/greeting", 0, MG_MQTT_QOS(0), "hello", 5);  
            }  
            break;  
        }  
    } // End of switch  
} // End of event_handler_mqtt
```

...

```
struct mg_connection *nc = mg_connect(&mgr, "192.168.5.1:1883", event_handler_mqtt);
if (nc == NULL) {
    printf("Error with mg_connect()\n");
}
```

### See also:

- [Mongoose networking library](#)

### Using Espruino as an MQTT client

The Espruino JavaScript environment has native MQTT support.

```
var ssid="RASPI3";
var password="password";

var wifi=require("Wifi");
wifi.connect(ssid, {password: password}, function() {
    console.log("Connected to access point");
    var mqtt = require("MQTT").create("192.168.5.1");
    mqtt.on("connected", function() {
        console.log("MQTT connected");
        mqtt.subscribe("test");
        mqtt.on('publish', function (pub) {
            console.log("topic: " + pub.topic);
            console.log("message: " + pub.message);
        });
    });
});
console.log("Doing a connect");
mqtt.connect();
});
```

### See also:

- [Espruino MQTT](#)

### Writing non ESP32 MQTT clients

Having an MQTT environment available is nice but without clients doesn't add much value. Your clients will be the applications that will register subscriptions and publish messages. The subscriber will name the topic on which messages published will be received.

While the MQTT protocol may be standardized, the client APIs appear to not be. As such there are multiple APIs for any given language.

## Eclipse paho

We start by creating a network representation object using `NewNetwork(&n)` followed by a connect to the host and port via `NetworkConnect()`. From there we have a number of MQTT primitives:

- `MQTTClientInit` – Initialize a client.
- `MQTTConnect` – Connect to an MQTT engine.
- `MQTTSubscribe` – Subscribe to a topic and invoke a message handler when a subscription message arrives.
- `MQTTUnsubscribe` – Unsubscribe from a topic.
- `MQTTPublish` – Publish a message to a topic.
- `MQTTDisconnect` – Disconnect from an MQTT server.
- `MQTTYield` – Unknown.
- `MQTTRun` – Run an MQTT client.

The message handler passed to `MQTTConnect()` is invoked when a message is received by the MQTT client after it has been published to the broker. The handler function has the following signature:

```
void function(MessageData *messageData)
```

The `MessageData` data type is a C structure containing:

- `MQTTMessage *message` – The message that was published.
- `MQTTString *topicName` – The topic on which the original message was published.

The `MQTTMessage` data type is a C structure containing:

- `enum QoS qos` – The quality of service of the published message.
- `unsigned char retained` – A flag indicating whether this was a retained message.
- `unsigned char dup` – A flag indicating whether this message was attempted to be delivered previously and hence may be a duplicate.
- `unsigned short id` – The identifier of this message.
- `void *payload` – A pointer to the payload of the message.
- `size_t payloadlen` – The size in bytes of the message.

Here is an illustrative client that takes a subscription:



See also:

- [Paho home page](#)
- [Practical MQTT with Paho](#)
- MQTTClientInit
- MQTTConnect
- MQTTDisconnect
- MQTTPublish
- MQTTUnsubscribe
- MQTTSubscribe

### C - Mosquitto client library

The library called `libmosquitto` is available for linking with C applications. You will need to install the package called `libmosquitto-dev`.

- `mosquitto_lib_version` – Determine the version of the library in use
- `mosquitto_lib_init` – Initialize the library
- `mosquitto_lib_cleanup` – Conclude the use of the library
- `mosquitto_new` – Create a client
- `mosquitto_destroy` – Destroy a client
- `mosquitto_reinitialize` – Destroy a client and then create a new one
- `mosquitto_username_pw_set` – Set the userid and password for authentication
- `mosquitto_will_set` – Set the last will of the client for estate planning purposes
- `mosquitto_will_clear` – Revoke the last will
- `mosquitto_connect` – Connect a client to a broker
- `mosquitto_connect_bind` – Same as `mosquitto_connect` but constrains interface to bind with
- `mosquitto_connect_async` – Asynchronous connection to the broker
- `mosquitto_reconnect` – Reconnect to a broker after a lost connection
- `mosquitto_reconnect_async` – Same as `mosquitto_reconnect` but asynchronous
- `mosquitto_disconnect` – Disconnect a client from a broker
- `mosquitto_publish` – Publish a message on a given topic
- `mosquitto_subscribe` – Subscribe to messages on a topic
- `mosquitto_unsubscribe` – Unsubscribe to messages on a topic

- `mosquitto_loop` – Perform processing for the `mosquitto` client. It is here that incoming message from the broker are received or previously unsent publications transmitted.
- `mosquitto_loop_read` –
- `mosquitto_loop_write` –
- `mosquitto_loop_misc` –
- `mosquitto_loop_forever` – Same as `mosquitto_loop` but does not return and keeps processing until the client is disconnected
- `mosquitto_socket` – Retrieve the low level TCP/IP socket that the `mosquitto` client is using
- `mosquitto_want_write` – Return true if there is pending data to be sent to the broker
- `mosquitto_loop_start` – Start a thread to process a `mosquitto_loop` in the background
- `mosquitto_loop_end` – Stop a previously started loop that was created using `mosquitto_loop_start`

Here is an example publishing client:

```
#include <stdio.h>
#include <string.h>
#include <mosquitto.h>

int main(int argc, char *argv[]) {
    char *host="pc9100";
    int port = 1883;
    char *message = "hello world!";
    char *topic = "greeting";

    mosquitto_lib_init();
    struct mosquitto *mosq = mosquitto_new(
        NULL, // Generate an id
        true, // Create a clean session
        NULL); // No callback param
    int rc = mosquitto_connect(
        mosq, // Client handle
        host, // Host of the broker
        port, // Port of the broker
        false); // No keepalive
    if (rc != MOSQ_ERR_SUCCESS) {
        printf("Error with connect: %d\n", rc);
        return(rc);
    }
    mosquitto_publish(
```

```

    mosq,          // Client handle
    NULL,         // Message id
    topic,        // Topic
    strlen(message)+1, // Length of message
    (const void *)message, // Message to be sent
    0, // QoS = 0
    false); // Not retained
mosquitto_destroy(mosq);
mosquitto_lib_cleanup();
}

```

See also:

- [man\(3\) – libmosquitto](#)
- [mosquitto.h](#)

### Node.js JavaScript - MQTT

There is Node.js package called `mqtt` that provides MQTT functions for JavaScript applications. To install this package we should run:

```
$ npm install mqtt
```

Here is a sample JavaScript application that acts as a publisher:

```

var mqtt = require("mqtt");
var client = mqtt.connect("mqtt://pc9100");
client.on('connect', function() {
  console.log("Connected ... now publishing");
  client.publish("greeting", "Hello from JavaScript");
  client.end();
});

```

And here is an application fragment that acts as a subscriber:

```

var mqtt = require("mqtt");
var client = mqtt.connect("mqtt://pc9100");
client.on('connect', function() {
  client.subscribe("greeting");
});
client.on('message', function(topic, message) {
  console.log("Received message for topic=" + topic + ", message=" + message);
});

```

Error handling can be accommodated by registering a client handler for an error event:

```

client.on("error", function(error) {
  console.log("We detected an error: " + error);
});

```

The full details of the API can be found on the NPM home page for the MQTT package.

At a high level, the functions are:

- `connect` – Connect to a broker.

- `Client.publish` – Publish a message. The message content may be a `Buffer` or a `string`. The identity of the topic on which the message is being published must also be supplied.
- `Client.subscribe` – Subscribe to a topic.
- `Client.unsubscribe` – Unsubscribe from a topic. The signature is:  

```
client.unsubscribe(topic, [options], [callback])
```
- `Client.end` – Close the client connection to the broker.
- `Client.handleMessage` – A mechanism for handling messages.

See also:

- [npm – mqtt](#)

### Browser JavaScript - MQTT

The Eclipse Paho project includes a JavaScript client API that is suitable for running within the context of a browser. This client API uses the HTML5 WebSocket API to communicate with an MQTT broker.

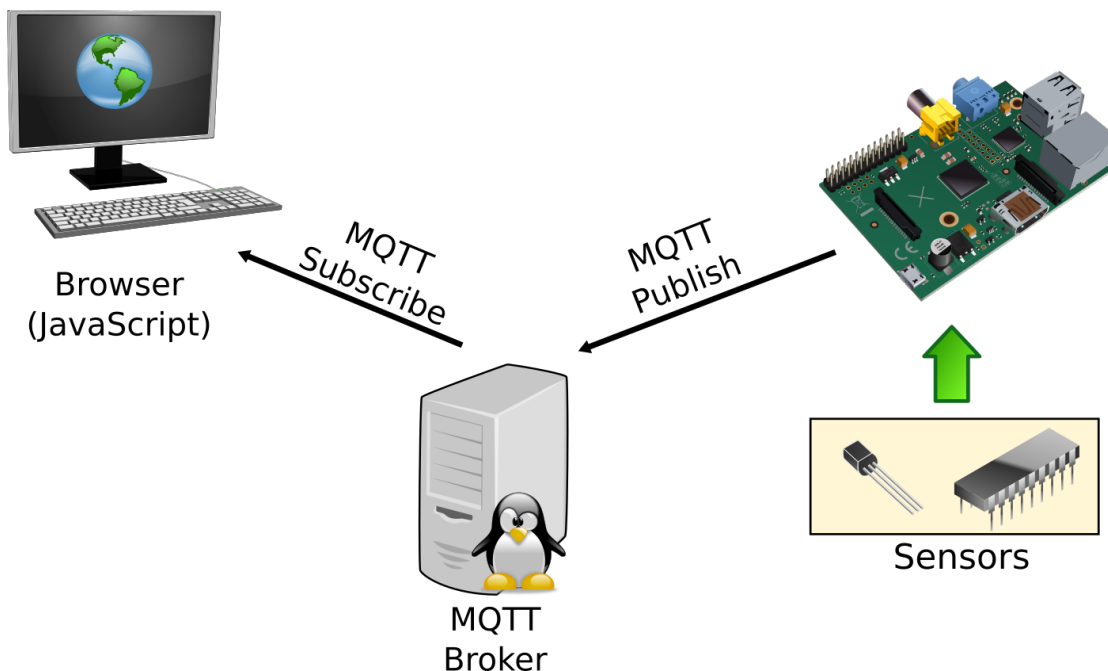

The MQTT broker chosen must support MQTT protocol through WebSocket. Popular brokers such as Mosquitto are able to perform that role. From a security standpoint, browsers are only allowed to make WebSocket requests back to the HTTP server from which the page running in the browser was originally loaded. As such, the browser can only make WebSocket requests to the MQTT broker if the MQTT broker served up the page. We can alleviate that issue by introducing full function Web Servers and proxies

into the story but for simple purposes, brokers such as Mosquitto can serve up static web pages directly. This means that we can point our browser to Mosquitto which will then look for an HTML file on the local file system to Mosquitto and send that back to the browser. The browser will now see the MQTT broker as the server of the web page and when the JavaScript in that web page asks for an MQTT subscription, it will succeed. Within the Mosquitto configuration file, each listener definition that wishes to also provide HTTP files must supply an "http\_dir" option which names the directory that will be searched for HTML file requests from the browser.

We are not limited running an MQTT broker on a separate server machine, we can run the MQTT broker directly on the Pi should we desire.

Now let us look and see what is needed to run an MQTT client in the browser.

First we need to download the Paho JavaScript client. If we visit the Paho downloads page:

<https://projects.eclipse.org/projects/technology.paho/downloads>

we will find an entry for "JavaScript client 1.0.1". Follow through that link and download the ZIP file. At the time of writing the result will be:

paho.javascript-1.0.1.zip

we can then unzip the file using `unzip`. Within we will find a file called `mqttws31.js`. This is the JavaScript source of the client and needs to be included in the HTML file that will be using MQTT. Here is an example HTML with embedded JavaScript illustrating us connecting to a broker and registering a subscription. When a message is published to the matching topic, it is logged to the browser console.

```
<html>
  <head>
    <script src="mqttws31.js"></script>
    <script>
var client = new Paho.MQTT.Client("192.168.1.101", 8081, "/", "CLIENT1");
client.onMessageArrived = function(message) {
  console.log("Message arrived ...: " + message.payloadString);
};
client.onMessageDelivered = function(message) {
  console.log("Message delivered ...");
};
client.connect({
  onSuccess: function() {
    console.log("On success ... we are now client connected to the broker!");
    client.subscribe("greeting", {
      onSuccess: function() {
        console.log("Subscription success ...");
      },
      onFailure: function(context, errorCode) {
```

```

        console.log("Failed to make a subscription ... code=" + errorCode);
    }
    });
},
onFailure: function(context, errorCode, errorMessage) {
    console.log("On failure ... code=" + errorCode + ", message=" + errorMessage);
}
});
</script>
</head>
<body>
</body>
</html>

```

Within the `mosquitto.conf` file, we will have an entry that looks like:

```

listener 1883
protocol mqtt

listener 8081
protocol websockets
http_dir /mnt/pc/projects/robot

```

This defines that we will listen on port 1883 for standard MQTT protocol while we will also listen on port 8081 for websocket HTTP requests and if a request to load a page arrives, we will serve it from a given directory.

The API to publish a message is called `send` and takes as a parameter an MQTT message object.

See also:

- [Eclipse Paho JavaScript client](#)
- [Paho API JavaScript documentation](#)
- [The Mosquitto MQTT broker gets Websockets support](#)

## CoAP - Constrained Application Protocol

When we typically think of networked computers, we imagine our desktop PCs. These have powerful CPUs, lots of memory, networking cards and unlimited electrical power sources (they are plugged into power outlets). Even our cell phones and tablets aren't too dissimilar to these desktop PCs. Their CPUs are still relatively powerful, RAM is still measured in megabytes and when the batteries in these devices gets low (after many hours of usage) we think nothing about recharging them.

With IoT devices, characteristics change. We have limited CPU capabilities, very low memory availability and electrical power is at a premium. For these devices to communicate, every moment of radio transmission is a drain on power consumption. If our transmission unit of information is 1000 bytes we could consider that 1000 units of

consumption. If we could reduce that to a 100 bytes or 10 bytes would the potentiality to improve our power usage by a factor of 10 or 100 ... and **that** is important.

If we think about common communication protocols like TCP/IP we will find that they are quite "chatty" and have relatively high overheads. If we go even further up the stack and start considering HTTP as a protocol, the overheads become extremely large. Layer on top of these other data such as JSON or XML ... and all of a sudden we find that the number of bytes we are passing for "control" and "structure" as compared to the actual content payload is grossly disproportionate. So ... why then do we use these protocols? The answer is standardization to achieve interoperability. We could invent any number of binary protocols that are solution specific but these, by definition, would have difficulty inter operating with each other. In addition, each time we wanted to leverage one of these protocols, we would have to go through some degree of learning curve. Not a great situation.

Thinking this through, we find that what we ideally want is a standardized protocol that is designed to accommodate as many IoT use cases as possible but yet is designed from the ground up to minimize byte sizes for transmission and hence reduce radio "on time". Such a standard has been written and is called "The Constrained Application Protocol" or "CoAP". This standard has been issued as an IETF request for comments (RFC 7252) which adds credibility to the selection. Let us now look and see how this standard can be utilized in an ESP32 environment.

0	1	2	3	4	5	6	7	8	9	0	1	2	3	4	5	6	7	8	9	0	1	2	3	4	5	6	7	8	9	0	1
Ver		T	TKL				Code					Message ID																			
Token (if any, TKL bytes) ...																															
Options (if any) ...																															
1	1	1	1	1	1	1	1	1	Payload (if any) ...																						

Ver: Version. Must be 0x01.

T: Type of message:

- Confirmable (0x00)
- Non-Confirmable (0x01)
- Acknowledgement (0x02)
- Reset (0x03)

TKL: Token length – A value between 0 and 8 (inclusive). 9-15 are reserved.

Code: An 8 bit unsigned value that is coded in 3 bits (called the class) and 5 bits (called the detail). The class can be:

- request – 0
- success response – 2
- client error response – 4
- server error response – 5

The options that follow are encoded for minimal space. While the encoding scheme is undoubtedly sensible to achieve minimum data size, it is worthless to describe its minutia here. Suffice it to say that there can be an arbitrary number of options of arbitrary length. Each option is represented by a numeric code and a value of zero or more bytes. There is a special "terminator" option type that can be used to terminate the sequence of options.

See also:

- [IETF RFC 7252 – The Constrained Application Protocol \(CoAP\)](#)

## FTP

FTP is the File Transfer Protocol. On Linux we can install an FTP server using:

```
$ sudo apt-get install ftpd
```

and we can install an FTP client using:

```
$ sudo apt-get install ftp
```

See also:

- FTP Server

## TFTP

The Trivial File Transfer Protocol is a simple protocol for moving named files around. The underlying transport is a sequence of data-grams as opposed to a connection.

It has no directory listing capabilities and no security features.

A TFTP server can be installed on Linux using:

```
$ sudo apt-get install tftpd
```

An implementation of a TFTP server is available as part of Kolban's C++ library.

A TFTP server listens on a well known port (69 by default). A client can either request to upload a new file or request to download a file.

For upload, this is called a "write request". The client sends a message of the format:



```

2 bytes      string      1 byte      string      1 byte
-----
| Opcode | Filename | 0 | Mode | 0 |
-----

```

The Opcode in this case will be WRQ (2). On receipt of the request, the TFTP server will create a new socket and bind it to a local port. It will then send an acknowledgment back to the client. An acknowledgment consists of:

```

2 bytes      2 bytes
-----
| Opcode | Block # |
-----

```

A WRQ is acknowledged with an ACK packet having a block number of 0. Following the acknowledgment, data packets will be received of the format:

```

2 bytes      2 bytes      n bytes
-----
| Opcode | Block # | Data |
-----

```

For a download a "read request" is received. The client sends a message of the format:

```

2 bytes      string      1 byte      string      1 byte
-----
| Opcode | Filename | 0 | Mode | 0 |
-----

```

This will then cause the TFTP server to send data packets and wait for a corresponding ACK. The TFTP server may send data in chunks of 512 bytes. To signal the end of the transmission, it will send a data block of less than 512 bytes in length. If the last block should happen to be exactly 512 blocks it will send a 0 length block after the ACK.

See also:

- [Wikipedia – Trivial File Transfer Protocol](#)
- [RFC1350 – The TFTP Protocol Rev 2](#)
- [atftp – man\(1\)](#)

## Telnet

An open source implementation of the telnet protocol is available on Github.

When we think of Telnet, we should imagine an initial conversation between the client and the server where they negotiate the options that each supports. Each possible

option is described by a `struct telnet_telopt_t` which defines whether "we" support it or not and whether "he" supports it or not. If we support an option, we supply `TELNET_WILL` and if not, we supply `TELNET_WONT`. If we require that the partner must do something we specify `TELNET_DO` otherwise `TELNET_DONT`.

We initialize a telnet environment with a call to `telnet_init()`. This has the signature:

```
telnet_t* telnet_init(
    const telnet_telopts_t* telopts,
    telnet_event_handler_t handler,
    unsigned char flags,
    void* userData)
```

The returned instance of `telnet_t` can be released with a call to `telnet_free()`.

On receipt of data from the partner, we pass that into the telnet environment with a call to `telnet_recv()`. This has the signature:

```
telnet_recv(
    telnet_t* telnet,
    const char* buffer,
    unsigned int size)
```

To send a telnet command, we execute `telnet_iac()`.

To negotiate an option, we use `telnet_negotiate()`.

To send data, we use `telnet_send()` or `telnet_printf()`.

For sub-option negotiation we have the pair `telnet_begin_sb()` and `telnet_finish_subnegotiation()`.

The event handler is an instance of a `telnet_event_handler_t` which is a function with the following signature:

```
void handler(telnet_t *telnet, telnet_event_t *event, void *userData)
```

A `telnet_event` always contains a field called `type` which identifies what type of event it is. The choices are:

- data
  - type
  - buffer
  - size
- error
  - type
  - file
  - func

- msg
- line
- errcode
- iac
  - type
  - cmd
- neg
  - type
  - telopt
- sub
  - type
  - buffer
  - size
  - telopt

The telnet types are:

- `TELNET_EV_DATA` – Data received from the partner.
- `TELNET_EV_SEND` – Request to send data to the partner.

See also:

- [Github: seanmiddleditch/libtelnet](#)
- [RFC854](#)
- [RFC855](#)

## DNS Protocol

The Domain Name Service protocol is responsible for resolving a domain name (eg. `www.google.com`) into the IP address that one should use to form a connection to that service provider. A TCP/IP network doesn't use string names but instead uses IP addresses which are typically 4 byte values. Since we humans don't want to try and remember these numbers there is the ability to provide a mapping from text names to those IP addresses. Servers located on the internet collaborate together to provide the mapping from names to addresses. Such servers are called "name servers". The

protocol an application uses to resolve a name to a corresponding IP address in the DNS protocol.

DNS servers typically listen on UDP port 53. When a local application has a domain name that it wishes to resolve to an IP address, it passes it to a local component logically called a "resolver". The resolver then works with distributed name servers to obtain the result.

When a UDP message is received by a DNS server, it has the following header:

0	1	2	3	4	5	6	7	8	9	10	11	12	13	14	15
ID															
QR	OPCODE				AA	TC	RD	RA	Z			RCODE			
QDCOUNT															
ANCOUNT															
NSCOUNT															
ARCOUNT															

- QR – Query/Response flag
  - 0 – query
  - 1 – response
- OPCODE
  - 0 – query
  - 1 – inverse query
  - 2 – server status request
- AA – Authoritative Answer
  - 0 – no
  - 1 – yes
- TC – Truncated Message
  - 0 – no
  - 1 - yes
- RD – Recursion Desired
- RA – Recursion Available
- Z – Reserved (must be 0)
- RCODE – Response code

- 0 – no error
- 1 – format error
- 2 – server failure
- 3 – name error
- 4 – not implemented
- 5 – refused

A Question section record has the format:

- QNAME – a repeating section
  - Length byte = 0 for last entry
  - Label for length bytes
- QTYPE – 16 bits
  - 1 – Host record (A)
  - 2 – NS record
- QCLASS – 16 bits
  - 1 – Internet

A response should also contain the original request.

An answer to a query is in the resource record format. The format of the record looks like:

- NAME – The domain name to which this record corresponds. This is the same format as the QNAME field.
- TYPE – Resource record type.
  - 1 – IPv4 Address
  - others ...
- CLASS – The class of data.
  - 1 – Internet
  - others ...
- TTL – A 32 bit unsigned supplying the seconds for which this record is valid for. A value of 0 means valid for this response but not to be cached.

- `RDLENGTH` – The size of `RDATA` as an unsigned 16 bit value.
- `RDATA` – The data of the response.

See also:

- [DNS Protocol](#)
- [RFC1035](#)
- [Network sorcery – DNS protocol](#)















## Mobile apps













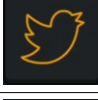

### Blynk

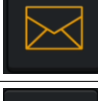
The high level notion of Blynk is to provide interaction between your cell phone (Android or IOS) and your ESP32. Let us now take a look at how this works.



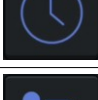

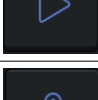





It basically is made up of two logical parts. You have an app called Blynk that you install and run on your cell phone. You also write or install an app on your ESP32. Once done, when you run your ESP32 app, it connects via the network to the Blynk server and Blynk knows that your ESP32 is up and running. On your cell-phone, you then run the cell phone hosted Blynk app. This also communicates with the Blynk server. The end results is that your cell phone and your ESP32 are in communication with each other. This means that you can push information from your phone to your ESP32 or, conversely, retrieve information from your ESP32 for display on your phone.

Blynk is made up of a canvas onto which you can place "widgets". Think of these like legos blocks you can compose your app with. There are a lot of widgets available to you. Here is a quick summary:

	Button – Associate a visual with a GPIO pin. Button can be either push/release or stateful.
	Slide – A slider provides a visual slide between two values. This is a horizontal slider which can be slid between the left and the right.
	Slide – A vertical slider.
	
	Joystick – Visualize a thumb based joystick.
	Color picker
	Step a value – horizontal layout.
	Step a value – vertical layout.
	
	
	A logical LED.
	Gauge
	LCD
	Super Chart

	Terminal
	Video Streaming
	Level
	Level
	Twitter
	Notification
	Email
	Device Selector
	Device Tiles
	Bridge
	Real Time Clock
	Eventor
	Music Player
	Web Hook
	Tabs



	Menu
	Table
	Time Input
	Map
	GPS Stream
	GPS Trigger
	Accelerometer
	Gravity Sensor
	Light Sensor
	Proximity Sensor
	Barometer Sensor

The ESP32 has a set of real/physical GPIO pins. These can be driven directly from Blynk. However, Blynk also has the notion of "virtual pins". These are the logical equivalent of "data sockets". The widgets can be configured to work with either the real physical pins (which Blynk calls digital pins) or the widgets can be configured to work with Virtual pins. When we work with virtual pins, we are sending or receiving data to the application running on the ESP32.

We can write data from the ESP32 app to Blynk using:

```
Blynk.virtualWrite(pin, data)
```

to handle incoming data from Blynk, we define a callback function:

```
BLYNK_WRITE(pin) {  
  // Handler code. The variable param is in scope holding the received data.  
}
```

Data arriving over a virtual pin can be of a variety of different types including numeric, string and arrays of values.

See also:

- [Blynk home page](#)
- [Blynk – ESP32](#)
- [YouTube: thingSoC ESP32 with Blynk](#)

## Cloud environments

It is becoming increasingly common to leverage the services of a cloud hosted environment to process Internet Of Things (IoT) based data. A cloud provider provides an end-point on the internet which is managed by the provider. It commonly accepts incoming data in a variety of protocols over a variety of transports and handles the data when it arrives. That could be as simple as storing it in a data store or could be more complex such as running a server side application on the received data. In addition to receiving the incoming data, some cloud environment provide the mechanics to manage an IoT based device such as controlling its operation or pushing new firmware to it. All of this is done at scale. The number of devices and the amounts of data needing to be transmitted can be as high as needed. Vendors offer these cloud based services for a fee. After all, running a server and ensuring it is operational requires resources including time, staff and systems. In addition, to accommodate large volumes of huge number of devices, these vendors may be managing high end environments including network redundancy, transparent fail-over and "elasticity" in the provisioned services ... growing as needed and shrinking when idle. The fees charged by the vendors are commonly "metric" based fees charged as a function of how much resources you consumed. A customer with 100 devices with 1 message a minute per device doesn't consume the same resources as a customer with 100000 devices with 10 messages a second per device. Consult with the vendors for pricing. Typically, many offer evaluation access (you can play for free for 30 days) or constrained access (you can submit 100 messages a day).

## IBM Bluemix

Bluemix is a quality offering from IBM that provides a wealth of cloud based capabilities including application hosting and much more. However, for our story, all we concern ourselves with is the IoT portion. With a Bluemix account, one can create "IoT

Services" which run in the Bluemix cloud. These become the "end-points" of an IoT client. For our discussions, such a client is an ESP32. When we configure a Bluemix IoT service we start by defining a logical device type. This allows us to model the characteristics of our IoT device and its properties. With a template of an IoT device type created, we can then tell Bluemix that we have device instances. Each instance is created from the IoT device type model and hence inherits its attributes. When we have modeled a device instance, Bluemix will supply us a security token which is a string of characters. When that actual device connects to Bluemix, the connection request will include the security token plus the identity name of the device. Bluemix will use this pair to validate that the device is who it claims to be.

We can model each instance of physical ESP32 devices in this manner or, we can have each instance use the same device identifier. Flexibility is the name of the game. By giving each device its own device identifier, we can instruct Bluemix to "disallow" specific connections from specific devices should we choose.

The messages sent by the ESP32 to Bluemix are based on the MQTT protocol so if we wish to write an ESP32 based Bluemix application, we would start by ensuring that we can publish MQTT messages. There are a variety of technologies to help us achieve that.

### **If This Then That - IFTTT**

The notion behind the "If This Then That" technology is the simple concept of pairing sources of events with actions that can be performed. The If This Then That (IFTTT) web site allows anyone to pair together a trigger (a source of an event) and action (an action to be performed). The sources of events are rich ... extremely rich and there are hundreds to choose from. However, from the perspective of an ESP32 programmer, there is one source that stands out ... it is called "Maker".



Once configured, we can send in a REST request with a JSON payload to a URL endpoint. The REST request includes:

- The type of event we are submitting
- A token that identifies the service we are targeting
- Three optional parameter values

Using this as a source of an event, we can then wire that into an action to be performed when such an event arrives. This takes us to the actions that can be performed by IFTTT. Once again there are hundreds of choices to choose from including sending SMS messages, emails, tweets and more ... including making a REST request which itself could be targeted at an ESP32.

See also:

- [IFTTT](#)

## ESP Mesh

The ESP Mesh is a collection of ESP32s that cooperate to form a mesh network. They organize themselves into a hierarchical tree structure of nodes. There are three types of node:

- root node
- intermediate node
- leaf node

There is only one instance of a root node. It connects to an access point that has Internet connectivity. This is also the single root of the tree structure.

Within a tree, we have the concept of parent / child relationships. A parent can have zero or more children and a child can have exactly one parent. The root node has no parent while both the intermediate and child nodes always have a parent. The root node and intermediate nodes also have children. The children can be either intermediate nodes or leaf nodes. A leaf node can have no children.

If we think in terms of data transmission:

The root node can receive data from the Internet and forward into the mesh or it can receive data from its children and forward to the Internet.

An intermediate node can receive data from its parent for routing to its children or receive data from its children for routing to its parent or other children.

A leaf node does not do any routing and either originates data for delivery to another leaf node or to the internet. It can also be the destination of data originating elsewhere.

In the WiFi specification (802.11) there is the concept of a beacon. This is a broadcast packet of data that is periodically transmitted by an access point. It is allowed to be received and decoded by any and all who may be in range. This packet contains logical pieces called Information Elements (IE). In the 802.11 specification, each Information Element contains an indication of *what it is* allowing receiver to know how to interpret its data. One of the architected types of Information Element is known as the Vendor

Specific Information Element and has an Information Element identifier of 221. The specification allows this element to contain vendor specific data the content of which is not described by the 802.11 specification and hence can be used for a variety of useful purposes. The size of the Vendor Specific Information Element can be up to 253 bytes of useful data.

See also:

- [Github: espressif/esp-mdf](#)
- [API Guides: ESP-MESH](#)
- [Information Embedding in IEEE 802.11 Beacon Frame](#)

## Storage programming

The notion of storage programming encompasses techniques for storing data for later retrieval or examination. The ESP32 has RAM but when the ESP32 is switched off, the RAM content is lost. As such we need a mechanism to make that storage more permanent. The ESP32 usually has access to flash memory that is electrically connected via a dedicated SPI bus. Typically the flash memory size is 4MBytes. We can access the flash memory through the SPI Flash APIs.

See also:

- SPI Flash

## Partition table

The ESP32 architects a concept called the partition table which is basically a "map" or "layout" of what is contained within the flash storage. The partition table is found at `0x8000` in flash for a length of `0xC00` bytes providing space for about 95 distinct table entries. Each entry in the table has a record structure which logically contains:

- `type` – The type of the partition. A byte value in the range of `0x00` to `0xFE` (`0xFF` is reserved as are codes in the range of `0x00` to `0x3F`). The ESP-IDF defines:
  - `data` – code 0
  - `app` – code 1
- `subtype` – The sub-type of the partition. A byte value. If the type is `app` or `data`, it can be one of:
  - `nvs` – Used for non volatile storage.
  - `phy`

- `factory`
- `coredump` – Used to hold core dumps.
- `ota_0, ... ora_15`
- `test`
- `fat` – Used for the FAT file system.
- `address` – The offset address (flash) of the start of the partition.
- `size` – The size of the partition in bytes.
- `label` – An optional null terminated string (max 16 characters + NULL)
- `encrypted` – Is the partition encrypted.

The partition table is read-only to our applications and can be accessed with a rich API provided by the ESP-IDF. The table is written into flash storage by the `esptool`.

The offset size is optional. Blank offsets will be placed contiguously after the previous data. Offsets are 64K aligned.

A tool called "`gen_esp32part.py`" is available as part of the tooling to build binary representations of the table. We can build a binary table from a comma separated value file using:

```
$ gen_esp32part.py -verify input_partitions.csv binary_partitions.bin
```

We can convert a binary file back to a CSV using:

```
$ gen_esp32part.py --verify binary_partitions.bin input_partitions.csv
```

and we can list the content of a binary file using:

```
$ gen_esp32part.py binary_partitions.bin
```

The partition table used by your application is defined by `make menuconfig` in the Partition Table entry:

```
/home/kolban/esp32/esptest/apps/workspace/mongoose/sdkconfig - Espressif IoT D
e
Espressif IoT Development Framework Configuration
Arrow keys navigate the menu. <Enter> selects submenus ---> (or
empty submenus ----). Highlighted letters are hotkeys. Pressing <Y>
includes, <N> excludes, <M> modularizes features. Press <Esc><Esc>
to exit, <?> for Help, </> for Search. Legend: [*] built-in [ ]

  SDK tool configuration --->
  Bootloader configuration --->
  Security features --->
  Serial flasher config --->
  Partition Table --->
  Optimization level (Debug) --->
  Component config --->

<Select> < Exit > < Help > < Save > < Load >
```

Within that section we have three possibilities:

```
/home/kolban/esp32/esptest/apps/workspace/mongoose/sdkconfig - Espressif IoT D
e> Partition Table
Partition Table
Use the arrow keys to navigate this window or press the
hotkey of the item you wish to select followed by the <SPACE
BAR>. Press <?> for additional information about this

  (X) Single factory app, no OTA
  ( ) Factory app, two OTA definitions
  ( ) Custom partition table CSV

<Select> < Help >
```

If we select to use a custom partition table, there are further options:

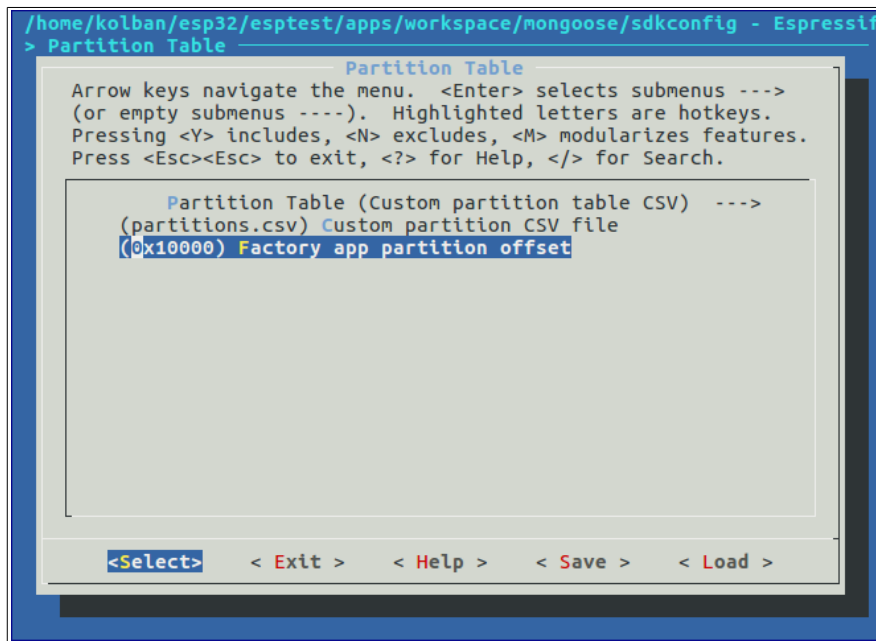

- Custom partition CSV file – The Comma Separated Values file that contains the text description of our partition definitions.
- Factory app partition offset – The location of our factory application.

I recommend starting with the ESP-IDF supplied partition table as a skeleton. Take a copy of this and place in your project. The supplied file can be found at:

```
<ESP-IDF>/components/partition_table/partitions_singleapp.csv
```

and copy this to the file:

```
partitions.csv
```

Since the partition table also defined the size of the factory application, we need to ensure that we make it large enough to hold the size of the compiled image. If not and the image becomes bigger than the partition size, we may find an error that looks like:

```
E (470) esp_image: Image length 1260048 doesn't fit in partition length 1048576
E (470) boot: Factory app partition is not bootable
E (472) boot: No bootable app partitions in the partition table
```

This error will show up at run-time. To fix, copy in a new `partitions.csv` and change the line which reads:

```
factory, app, factory, 0x10000, 1M
```

to

```
factory, app, factory, 0x10000, 2M
```

See also:



- [Partition API](#)
- [esp\\_vfs\\_fat\\_spiflash\\_mount](#)
- [esp\\_vfs\\_fat\\_register](#)
- [ESP32 Docs – Partition Tables](#)
- [ESP32 Docs – Partition table APIs](#)

## Non Volatile Storage

Non volatile storage is memory that can be written to such that after a power off or restart, the same data can be read again without it having been lost. It is preserved over a restart. Within this data we can store configuration and operational values for our applications. For example, we might store the network SSID and password such that when the device is restarted, it knows which network to connect to and the password to present.

The storage is partitioned into named areas. For a given named area, we can then write name/value pairs to the storage and also read previously written name/value pairs. There are getter/setter functions for most data types including signed and unsigned integers, strings and blobs of data.

Before attempting to use any NVS functions, we should call `nvs_flash_init()` to initialize the environment.

A named area is opened for access with a call to `nvs_open()`. The name of the area is passed in as a parameter. We are returned a logical "handle" that we can subsequently use to refer to this storage area. Once we have a handle, we can get/set items of named data. The data items are referenced by a key name ... effectively turning the storage area into a hash map. If we change data by performing a `set` function, this does not automatically cause the data to be written to the nonvolatile storage. Instead, the storage is updated when we call `nvs_commit()`. It is up to the internal implementation as to when the actual update is performed and it *could* happen prior to `nvs_commit()`. The contract is that when we return from `nvs_commit()` then we are assured that all updates have been processed. When we have done all our sets and gets, we should call `nvs_close()` to declare that we are not going to work with storage any more at this time so that the run-time can clean up any resources it may have opened.

The details of the algorithms used to manage NVS are exposed in the documentation. The high level intent of NVS is to store simple strings and integers and other flags as opposed to be a rich "file system" like structure. There is currently no de-fragmentation performed on the storage. A question that comes up from time to time is whether there is wear leveling on the use of NVS? This is the notion that continual writes to storage

should not exclusively re-use the same memory locations which have a finite capacity for writes. While it is believed that the NVS storage does **not** continually over-write the same storage locations it also doesn't use a true wear leveling algorithm. Re-writes of storage won't result in the continuous re-use of the same memory sections but conversely, the algorithms at play don't try and optimize for wear levelling.

See also:

- `nvs_flash_init`
- `nvs_open`
- `nvs_commit`
- `nvs_close`

## Virtual File System

The Virtual File System (VFS) is the architecture provided by the ESP-IDF that gives us the capability of saving and loading data from our applications using a file system I/O. The VFS isn't tied to any one particular technology but is instead an architectural abstraction used to provide the I/O interface to a variety of different implementations.

The key to the VFS is a data type called `esp_vfs_t`. This structure contains the following:

- `fd_offset` –
- `flags` – Operational flags. Use `ESP_VFS_FLAG_DEFAULT`.
- `close/close_p` – Close a previously opened file.
- `closedir/closedir_p` – Close a previously opened directory.
- `fstat/fstat_p` – Get stats/details of a file.
- `link/link_p` – Create a new link to a file.
- `lseek/lseek_p` – Change the data pointer within a file.
- `mkdir/mkdir_p` – Create a new directory entry.
- `open/open_p` – Open a named file.
- `opendir/opendir_p` – Open a directory for reading.
- `read/read_p` – Read the contents of a file.
- `readdir/readdir_p` – Read a record from a directory.
- `rename/rename_p` – Rename a file.
- `rmdir/rmdir_p` – Delete a directory entry.
- `seekdir/seekdir_p` – Set the position of the next `readdir()`.

- `stat/stat_p` – Get stats/details of a file.
- `tellmdir/tellmdir_p` – Return the current direction stream.
- `unlink/unlink_p` – Remove a file.
- `write/write_p` – Write into a file.

After populating the structure, we need to register our new virtual file system with a call to `esp_vfs_register()`.

We need to be cognizant that the intended caller of file I/O expects a POSIX like environment.

See also:

- `esp_vfs_register`
- [Virtual filesystem component](#)

## VFS Implementations

Since the VFS provides an architectural model, we need to consider actual implementations of it. As of 2016-11, none are yet available. The first anticipated implementations will be file systems stored in flash. These will provide persistent storage of data through a file API. Potential implementations will include FAT or SPIFFS.

We can also produce our own specialized implementations. One interesting idea is to allow the ESP32 to be a network client of external file systems. Possibilities include:

- NFS
- SSH
- FTP
- TFTP
- HTTP servers
- Google Drive
- Other cloud based systems

It may seem strange to have a network device access data through a file mechanism only to have it then farm out the requests as another network call ... however there may be benefits. The ESP32 could cache the received data either in RAM or local flash and only perform external network requests if the requested data is not available elsewhere.

When working with file I/O, we can use the streams file mechanisms imported via "stdio.h" or use the lower level file I/O imported through "fcntl.h".

See also:

- [VFS mapping to SPIFFS](#)

## FATFS File System

The FatFs file system is an implementation of the FAT/exFAT file system as found in earlier PC operating systems such as MS-DOS and early Windows (before FAT32 and NTFS). The implementation is open source and is supplied "pre-ported" to the ESP32 as part of the ESP-IDF distribution.

The ESP-IDF mapping for the FATFS maps the file system to the posix IO functions. This means that we don't need to learn any *special* APIs in order to read and write files. We can use `open()`, `close()`, `read()`, `write()` and the other methods exposed through Virtual File System.

There are two backing stores provided for the file system. The first is flash memory that is electrically attached to the ESP32. The second is an SD card (removable storage) that can be mounted.

Before we can use these APIs, we need to perform some preliminary setup.

1. Call `esp_vfs_fat_register`
2. Call `ff_diskio_register`
3. Call `f_mount`

To unregister

1. Close all open files
2. Call `f_mount` with NULL
3. Call `ff_diskio_register` with NULL
4. Call `esp_vfs_fat_unregister`

By default, the filenames are constrained to the old 8.3 format (short names), however, should we choose, we can enable long file name control in the make menuconfig settings.

See also:

- [ESP-IDF Programming Guide – FAT Filesystem Support](#)
- [ESP-IDF Programming Guide – Wear Levelling APIs](#)
- [FatFS – Generic FAT File System Module](#)
- Virtual File System
- FatFs file system
- `esp_vfs_fat_register`
- `ff_diskio_register`
- `f_mount`
- `esp_vfs_fat_spiflash_mount`

## Spiffs File System

The SPI Flash File System (SPIFFS) is a file system mechanism intended for embedded devices. To configure SPIFFS we need to determine some numbers.

First is the physical page size. Next comes the physical block size. Next we decide on the logical block size. This will be some integer multiplier of the physical block size. The whole SPIFFS file system must be a multiple of the logical block size. Next comes the logical page size which is some multiplier of the logical block size.

A common ESP32 sizing is 64K for the logical block size and 256 for the logical page size.

To be clear a 1 block is  $n \times$  pages.

When a SPIFFS API call is made, a zero or positive response indicates success while a value  $< 0$  indicates an error. The nature of the error can be retrieved through the `SPIFFS_errno()` call.

The SPIFFS implementation does not directly access the flash memory. Instead, a functional area called a hardware abstraction layer ("hal") provides this service. A SPIFFS integration requires that three functions be created that have the following signatures:

```
s32_t (*spiffs_read)(u32_t addr, u32_t size, u8_t *dst)
s32_t (*spiffs_write)(u32_t addr, u32_t size, u8_t *src)
s32_t (*spiffs_erase)(u32_t addr, u32_t size)
```

If they succeed, the return code should be `SPIFFS_OK (0)`. On an ESP32, these will map to the SPI flash APIs.

To use a SPIFFS file system, we must perform a call to `SPIFFS_mount()`. This takes as input a configuration structure that tells SPIFFS how much flash is available and a variety of other properties. In addition, some working storage must be allocated for various internal operations. These sizes can be tuned.

Here is an example of configuration for mounting a file systems:

```
#define LOG_PAGE_SIZE      256

static uint8_t spiffs_work_buf[LOG_PAGE_SIZE*2];
static uint8_t spiffs_fds[32*sizeof(uint32_t)];
static uint8_t spiffs_cache_buf[(LOG_PAGE_SIZE+32)*4];

spiffs fs;
spiffs_config cfg;
cfg.phys_size = 512*1024; // use 512K
cfg.phys_addr = 2*1024*1024 - cfg.phys_size; // start spiffs at 2MB - 512K
cfg.phys_erase_block = 65536; // according to datasheet
cfg.log_block_size = 65536; // let us not complicate things
cfg.log_page_size = LOG_PAGE_SIZE; // as we said

cfg.hal_read_f = esp32_spi_flash_read;
cfg.hal_write_f = esp32_spi_flash_write;
cfg.hal_erase_f = esp32_spi_flash_erase;

int res = SPIFFS_mount(&fs,
    &cfg,
    spiffs_work_buf,
    spiffs_fds,
    sizeof(spiffs_fds),
    spiffs_cache_buf,
    sizeof(spiffs_cache_buf),
    0);
```

Once we have mounted the file system, we can then open a file, write content into it and close it. For example:

```
char *fileName = "/f1/my_file";
spiffs_file fd = SPIFFS_open(&fs, fileName,
    SPIFFS_CREAT | SPIFFS_TRUNC | SPIFFS_RDWR, 0);
SPIFFS_write(&fs, fd, (u8_t *)"Hello world", 12);
SPIFFS_close(&fs, fd);
```

Similarly, if we wish to read data from the file we can perform the following:

```
char buf[12];
spiffs_file fd = SPIFFS_open(&fs, fileName, SPIFFS_RDWR, 0);
SPIFFS_read(&fs, fd, (u8_t *)buf, 12);
SPIFFS_close(&fs, fd);
```

The SPIFFS file system could be hierarchical in nature such that it contains both directories and files but it seems that in reality it is not. There is only one directory called the root. The root directory is "/". To determine the members of a directory, we can open a directory for reading with the `SPIFFS_opendir()` API and, when we are finished, close the reading operation with a `SPIFFS_closedir()` API call. We can walk through the directory entries with calls to `SPIFFS_readdir()`.

For example:

```
spiffs_DIR spiffsDir;
SPIFFS_opendir(&fs, "/", &spiffsDir);
struct spiffs_dirent spiffsDirEnt;
while(SPIFFS_readdir(&spiffsDir, &spiffsDirEnt) != 0) {
    printf("Got a directory entry: %s\n", spiffsDirEnt.name);
}
SPIFFS_closedir(&spiffsDir);
```

To make this clear, in Linux, if we created `"/a/b/c.txt"` this would normally create a file called `"c.txt"` in a directory called `"b"` in a directory called `"a"`. In SPIFFS, this actually creates a single file called `"/a/b/c.txt"` where the `"/"` characters are merely part of the file name. When we perform `SPIFFS_opendir()`, there isn't actually a directory structure but just one single flat list of ALL files which may or may not have "slashes" in their names.

To create a file, we can use the `SPIFFS_open()` API by supplying a `SPIFFS_CREAT` flag.

See also:

- SPIFFS API
- Github: [pellepl/spiffs](#)
- Github: [igrr/mkspiffs](#) – The mkspiffs tool.
- SPI Flash
- [Virtual File System mapping to SPIFFS](#)

## Building SPIFFs for the ESP32

Under the heading of "let's build on each other", an excellent job has been done of porting SPIFFs to the ESP32 by the LUA team (Jaume Olivé Petrus). The source code can be found:

<https://github.com/whitecatboard/Lua-RTOS-ESP32/tree/master/components/spiffs>.

They have packaged it as an ESP-IDF component.

## mkspiffs tool

In addition to the fantastic SPIFFs library, there is also a tool called "mkspiffs" that can take a directory structure on your file system and build a SPIFFs image from it that can then be loaded into flash memory to provide pre-loaded data.

One can download the Git repository for mkspiffs and compile it. I found no issues and it compiled at first go.

The syntax is:

```
mkspiffs { -c <packdir> | -u <destdir>|-l|-i} \  
        -b <number> -p <number> -s <number>
```

One of:

- -c <directory to pack>
- -u <dest to unpack into>
- -l – list content
- -i – visualize content

and

- -b <number> – Block size in bytes (for example 65536)
- -p <number> – Page size in bytes (for example 256)
- -s <number> – fs image size in bytes.

Visualizing an image file shows results such as:

```
0 idid_____ era_cnt: 0  
1 _____ era_cnt: 0  
2 _____ era_cnt: 0  
3 _____ era_cnt: 0  
4 _____ era_cnt: 0  
5 _____ era_cnt: 0  
6 _____ era_cnt: 0  
7 _____ era_cnt: 0  
8 _____ era_cnt: 0  
9 _____ era_cnt: 0  
10 _____ era_cnt: 0  
11 _____ era_cnt: 0  
12 _____ era_cnt: 0  
13 _____ era_cnt: 0  
14 _____ era_cnt: 0  
15 _____ era_cnt: 0  
era_cnt_max: 1  
last_errno: 0  
blocks: 16  
free_blocks: 15  
page_alloc: 4  
page_delet: 0  
used: 1004 of 52961  
total: 52961  
used: 1004
```

Once we have an image file, we can the load it to flash with:



```
esptool.py --chip esp32 --port "/dev/ttyUSB0" --baud 115200 write_flash -z
--flash_mode "dio" --flash_freq "40m" <address> <file>
```

See also:

- [Github: igrr/mkspiffs](#) – The mkspiffs tool.

## The ESP File System - EspFs

Part of the Github project known as "Spritetm/libesphttpd" is a module called "espfs" which is the "ESP File System". What this module does is allow one to make an image from a set of files on your PC and store that image in flash memory. From there, a set of APIs are provided to read and access those files and their content. It is vital to note that the data in these files is read-only. There is no API to update the content of the files. Only the data that is initially written to flash is available to be read.

As part of the project there is a utility called "mkespfsimage" that takes as input a set of file names and streams as output the image data that should be flashed. For example:

```
find | ./mkespfsimage [-c compressor] [-l compression_level] > out.espfs
```

(Note that the project has compression capabilities that I am ignoring at this point).

Once the data is in flash, we can then use the APIs supplied by the component to perform the underlying data access.

They are:

- `EspFsInitResult espFsInit(void *flashAddress)`
- `int espFsFlags(EspFsFile *fh)`
- `EspFsFile *espFsOpen(char *fileName)`
- `int espFsRead(EspFsFile *fh, char *buff, int len)`
- `void espFsClose(EspFsFile *fh)`

An attempt to port the code to utilize ESP32 technologies was undertaken and can be found here:

<https://github.com/nkolban/esp32-snippets/tree/master/filesystems/espfs>

This adds a new function called:

- `int espFsAccess(EspFsFile *fh, void **buf, size_t *len)`

This function returns a pointer to the whole content of the file which is stored in `buf`. The length of the file is stored in `len` and also returned from the function as a whole. The data is accessed directly from flash without any RAM copies.

In addition, the function called:

- `EspFsInitResult espFsInit(void *flashAddress, size_t size)`

was augmented to include the size of the flash storage to map.

Here is an example application:

```
ESP_LOGD(tag, "Flash address is 0x%x", (int)flashAddress);
if (espFsInit(flashAddress, 64*1024) != ESPFS_INIT_RESULT_OK) {
    ESP_LOGD(tag, "Failed to initialize espfs");
    return;
}

EspFsFile *fh = espFsOpen("files/test3.txt");

if (fh != NULL) {
    int sizeRead = 0;
    char buff[5*1024];
    sizeRead = espFsRead(fh, buff, sizeof(buff));
    ESP_LOGD(tag, "Result: %.*s", sizeRead, buff);

    size_t fileSize;
    char *data;
    sizeRead = espFsAccess(fh, (void **)&data, &fileSize);
    ESP_LOGD(tag, "Result from access: %.*s", fileSize, data);

    espFsClose(fh);
}
```

## SD, MMC and SDIO interfacing

Secure Digital (SD) is a standard for removable media. These devices are also known as "flash cards" or "SD cards". The idea is that an SD card contains data that can be both read and written. The SD cards store the data as raw memory and it is common to create a file system that lives on top of the data. The FAT16 and FAT32 file system formats are commonly used. SD cards come in a variety of physical dimensions and with a variety of capacities and speeds. For the physical dimensions there are three distinct types known as "SD", "miniSD" and "microSD" ranging from largest to smallest. For capacity, there are again three distinct types known as "SD", "SDHC" and "SDXC".

	SD	SDHC	SDXC
Capacity	x <= 2GB	2GB <= x <= 32GB	32GB <= x <= 2TB
File system	FAT12, FAT16	FAT32	exFAT

For our story, we will ignore SDXC.

An additional characteristic of SD cards is their rated speed. The common speeds are:

Class 2	2MB/s
Class 4	4MB/s
Class 6	6MB/s
Class 10	10MB/s

The SD specification is large and comprehensive. If we were to try and implement the SD specification ourselves we would be delving down into a whole host of puzzles. As such, it is common to leverage pre-existing implementations of the specification and, thankfully, the ESP-IDF provides us with exactly that.

There is also an excellent example application provide in the `examples/storage/sd_card` directory of the ESP-IDF.

The SD card can be used to hold data but can not be used to hold instruction code for execution. As such, the SD card shouldn't be considered as an alternative to the flash memory accessible via SPI for code storage. The SD card should be used to store application data that can be read by or written by running applications.

See also:

- [SDMMC](#)
- [Wikipedia: Multi Media Card](#)
- [Wikipedia: Secure Digital](#)
- [SD Association](#)

### SD attachment on Wrover Dev Kit

The Espressif Wrover Dev Kit comes with a microSD card pre-attached. This is connected as follows:

Function	Pin
SD_HOST_D0	GPIO2
SD_HOST_D1	GPIO4
SD_HOST_D2	GPIO12
SD_HOST_D3	GPIO13
SD_HOST_CMD	GPIO15
SD_HOST_CLK	GPIO14
SD_HOST_DET	GPIO21

## ZIP files

The ZIP file format is a common technique for archiving and compressing a set of files into a single file for subsequent extraction.

On Linux, for example:

```
$ zip -r mydata.zip mydir
```

The ESP32 ROM contains some of the functions supplied for compression. See for example the header file found at `components/esp32/include/rom/miniz.h`.

See also:

- [libzip](#)
- [Github: kuba--/zip](#)
- [miniz](#)
- [Github: miniz](#)
- [man\(1\) – zip](#)
- [zlib](#)

## zlib

Zlib is a library for compression/decompression of data. The distribution of zlib can be found at [zlib.net](#). A clean compile was had after adding:

```
#include <unistd.h>
```

```
to gzguts.h.
```

See also:

- [Github: lboris/ESP32\\_curl\\_example/components/zlib](#)

## miniz

```
mz_zip_zero_struct(mz_zip_archive *pZip)
```

## Initialize a reader

```
mz_bool mz_zip_reader_init_mem(  
    mz_zip_archive *pZip,  
    const void *pMem,  
    mz_uint64 size,  
    mz_uint flags)  
  
mz_zip_reader_get_num_files(mz_zip_archive *pZip)  
  
mz_bool mz_zip_reader_end(mz_zip_archive *pZip)  
  
mz_zip_error mz_zip_get_last_error(mz_zip_archive *pZip);
```

## kuba--/zip

```
zip_open(const char *fileName, int level, char mode)
```

```
zip_close
```

zip\_entry\_open

zip\_entry\_close

zip\_entry\_read

## Charting data

Consider some of the sensors we have been discussing. By definition, a sensor reports on data that it measures. We can have our ESP32 perform actions based on the sensed data, however there are other things that we might want to do with that data. For example, using a temperature and pressure sensor, we almost immediately have a weather station and we might like to chart our data over time. This then leads us to think about different charting options available to us.

The puzzle of charting data can usually be broken up into a set of distinct areas:

1. Reading data from sensors.
2. Recording / transmitting the sensor data.
3. Drawing / updating the charts from the data.

The first of these we won't discuss here. The reason for that is that the techniques for interacting with a sensor varies by sensor type and, as such, are wide and varied and covered elsewhere in this book.

Once we have started reading data from the sensor, what are we to do with it? There are some obvious possibilities. The first is to save it locally on the ESP32 for subsequent retrieval or analysis. We can write our data into flash memory or into a micro SD card. This data can then be subsequently processed at a later time on the ESP32 or in the case of a micro SD card, the card can be extracted and placed in another reader. While this is of course of some use, the real beauty of the ESP32 is its ability to form network connections. If the ESP32 were to form a network connection to a some "consumer" of the data, then the data could either be extracted at a later time or, as we are about to discuss, could be used to stream the data live from the device.

If we read data from a sensor and have a TCP connection to the ESP32 from some external computer, the ESP32 could send the data down the TCP connection for consumption at the receiver. This way the ESP32 would not need to locally save the data as it is immediately off-loaded to the back-end computer. With cloud based technologies, we can choose a cloud provider and send the data there. Alternatively, we can use simple tools to get the data from Windows or Linux as the target of the ESP32 transmitted readings.

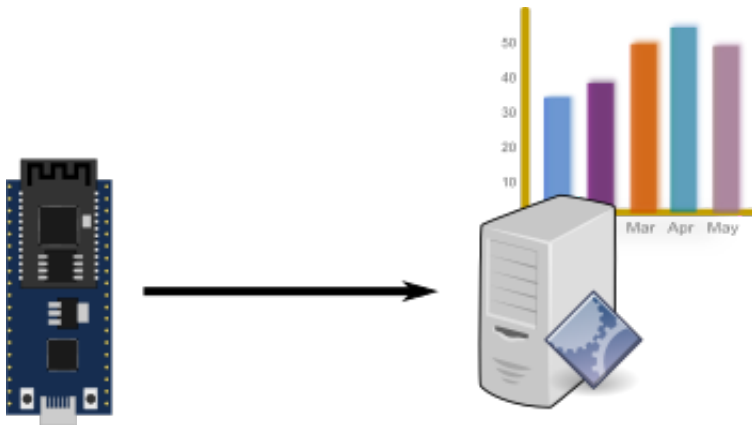

An example of such a tool is the Linux "netcat" launched through "nc". This can be connected to an arbitrary IP/port pair and echos the data received to stdout. We can redirect the output to a file and we end up with a growing file of data. The ESP32 app reading from the sensor can then send the sensor data (perhaps formatted for output) down the socket and it will end up in the file.

## Kst

The latest version of Kst is launched from Linux using "kst2".

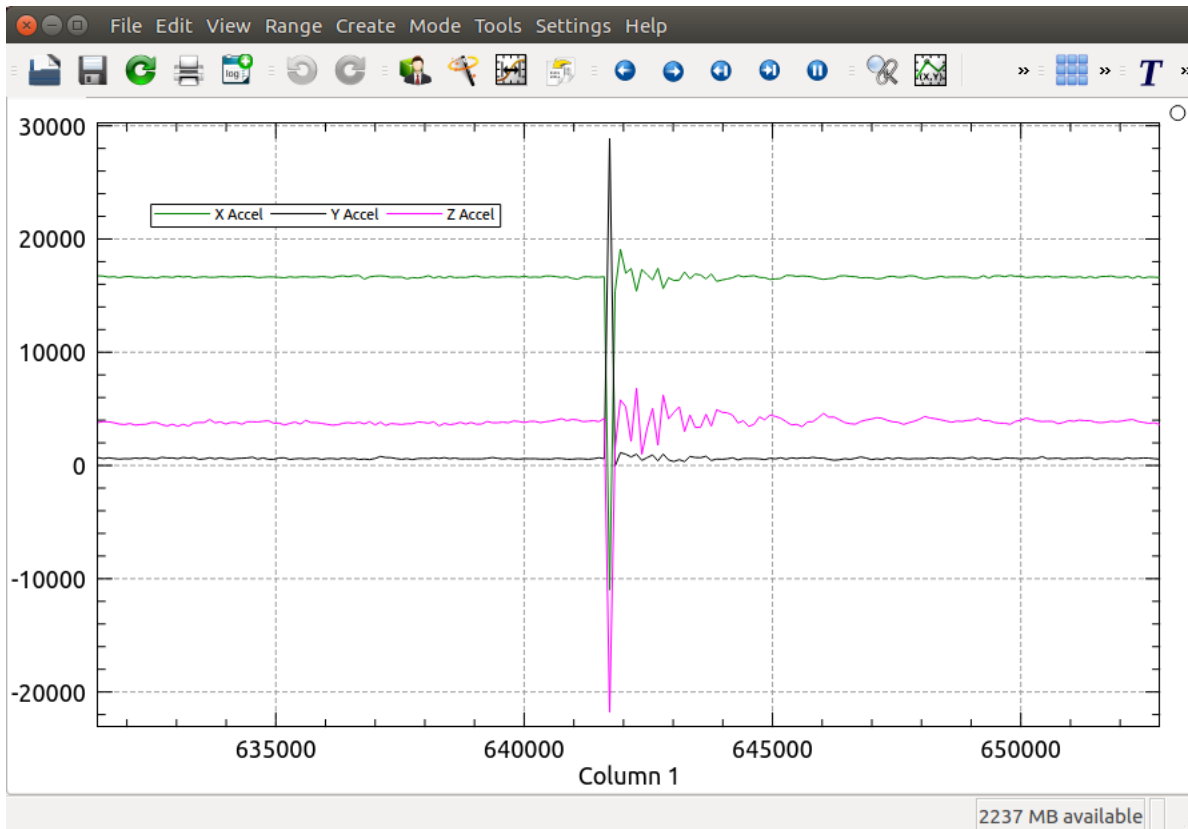

See also:

- [Kst home page](#)

## Sample Snippets

There are times when all we need is a snippet of code that we can copy to achieve a task. Here we present a set of such snippets that may of use simply by copying and pasting them. A repository on Github has been created for hosting the snippets. The repository may be found at:

<https://github.com/nkolban/esp32-snippets>

Included in the repository are:

- [vfs/vfs-skeleton](#) – A sample skeleton app for VFS

## Sample applications

Reading and reviewing sample applications is good practice. It allows you to study what others have written and see if you can understand each of the statements and the program flow as a whole.

### Sample - Ultrasonic distance measurement

The HC SR-04 is an ultrasonic distance measurement sensor.



Send a minimum of a 10us pulse to `Trig` (low to high to low). Later, `Echo` will go low/high/low. The time that `Echo` is high is the time it takes the sonic pulse to reach a back-end and bounce back.

Speed of sound is 340.29 m/s ( $340.29 * 39.3701$  inches/sec). Call this  $V_{\text{sound}}$ .

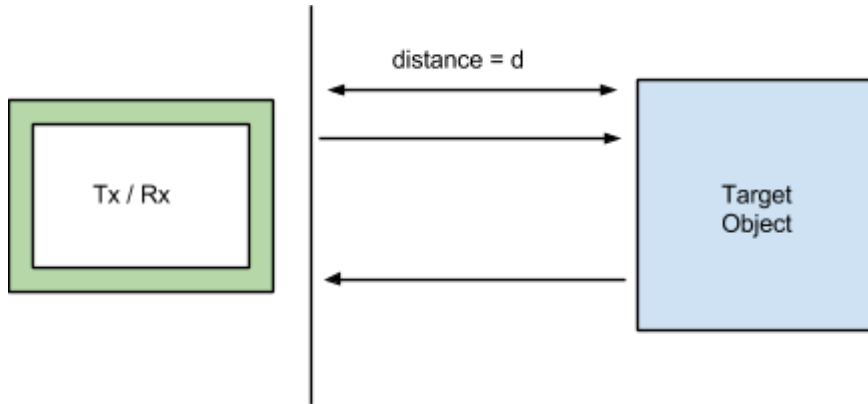

If  $T_{\text{echo}}$  is the time for echo response then  $d = (T_{\text{echo}} * V_{\text{sound}}) / 2$ .

Also the equation for expected  $T_{\text{echo}}$  lengths is given by:

$$T_{\text{echo}} = 2d/V_{\text{sound}}$$

For example:

Distance	Time
1cm	$2 * 0.01 / 340 = 0.058 \text{ msecs} = 59 \text{ usecs}$
10cm	$2 * 0.1 / 340 = 0.59 \text{ msecs} = 590 \text{ usecs}$
1m	$2 * 1 / 340 = 5.9 \text{ msecs} = 5900 \text{ usecs} (5.9 \text{ msecs})$

Because the Echo response is a 5V signal, it is vital to reduce this to 3.3V for input into the ESP32. A voltage divider will work. The pins on the device are:

- $V_{\text{cc}}$  – The input voltage is 5V.
- Trig – Pulse (low to high) to trigger a transmission ... minimum of 10usecs.
- Echo – Pulses low to high to low when an echo is received. Warning, this is a 5V output.
- Gnd – Ground.

To drive this device, we need to utilize two pins on the ESP32 that we will logically call Trig and Echo. In my design, I set Trig to be GPIO17 and Echo to be GPIO16.



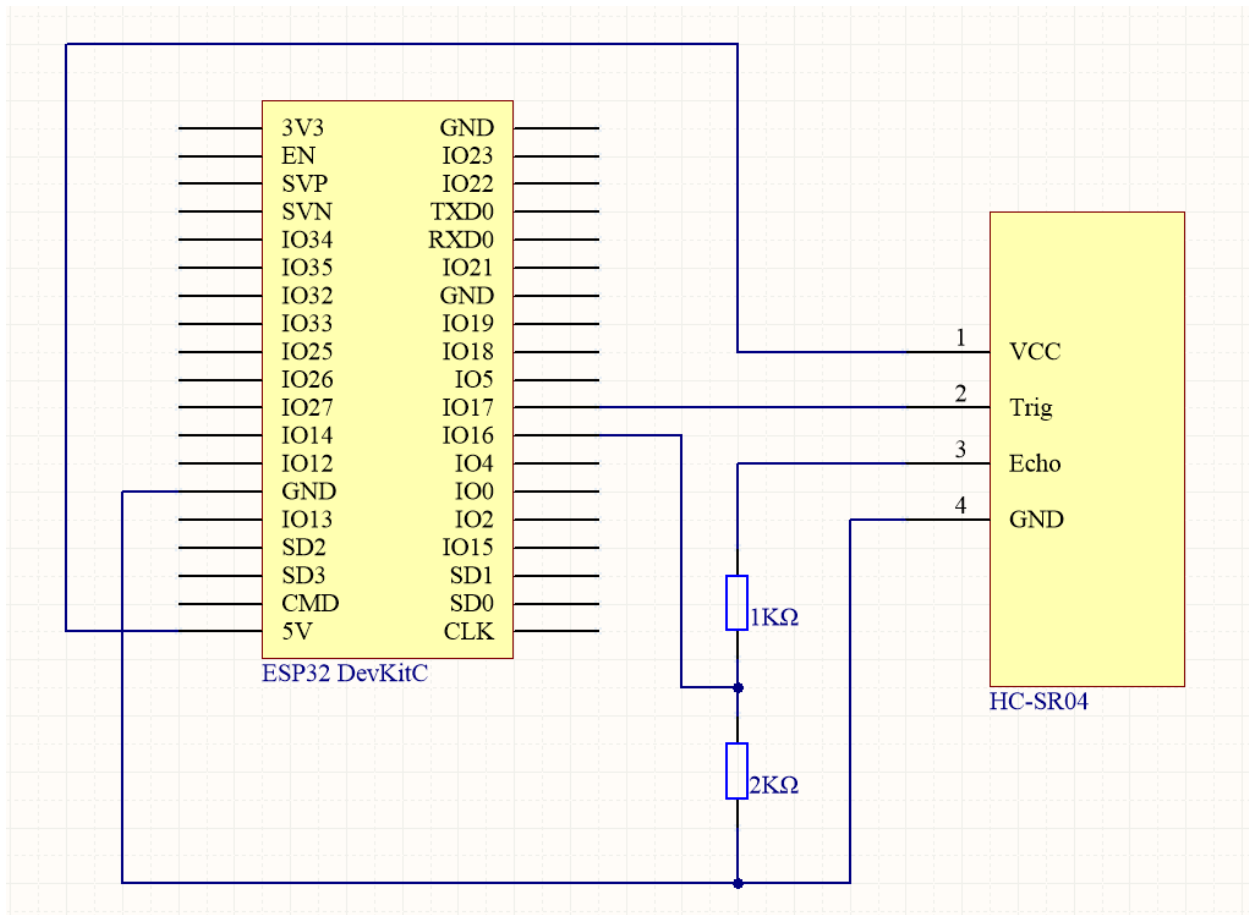

Our design for the application will not include any networking but it should be straightforward to add it as needed. We will setup a timer that fires once a second which is how often we wish to take a measurement. When the timer wakes up, we will pulse Trig from low to high and back to low holding high for 10 microseconds. We will now record the time and start polling the Echo pin waiting for it to go high. When it does, we will record the time again and subtracting one from the one will tell us how long it took the sound to bounce back. From that we can calculate the distance to an object. If no response is received in 20 msecs, we will assume that there was no object to detect. We will then log the result to the Serial console.

An example program that performs this design is shown next:

```
void mainThread(void *data) {
    gpio_pad_select_gpio(TRIG);
    gpio_pad_select_gpio(ECHO);
    gpio_set_direction(TRIG, GPIO_MODE_OUTPUT);
    gpio_set_direction(ECHO, GPIO_MODE_INPUT);
    while (1) {
        gpio_set_level(TRIG, 1);
        ets_delay_us(100);
```

```

gpio_set_level(TRIG, 0);
uint32_t startTime = system_get_time();
// Wait for echo to go high and THEN start the time
while (gpio_get_level(ECHO) == 0 &&
      (system_get_time() - startTime) < 500 * 1000) {

}
startTime = system_get_time();
while (gpio_get_level(ECHO) == 1 &&
      (system_get_time() - startTime) < 500 * 1000) {
    // Do nothing;
}
if (gpio_get_level(ECHO) == 0) {
    uint32_t diff = system_get_time() - startTime; // Diff time in uSecs
    // Distance is TimeEchoInSeconds * SpeedOfSound / 2
    double distance = 340.29 * diff / (1000 * 1000 * 2); // Distance in meters
    printf("Distance is %f cm\n", distance * 100);

} else {
    // No value
    printf("Did not receive a response!\n");
}
// Delay and re run.
vTaskDelay(1000 / portTICK_PERIOD_MS);
}
}

```

Once this has been written and tested, we will make a second pass at the puzzle but this time using an interrupt to trigger the response to the echo.

See also:

- GPIOs

## Sample - WiFi Scanner

A WiFi scanner is an application which periodically scans for available WiFi networks and shows them to the user. In our design, we will scan periodically and remember the set of networks we find. When we perform re-scans, we will check to see if each of the networks located is a network we have previously seen and, if not, list it to the user. We will also keep a "last seen" time for each network and if a network has not been seen for a minute, then we will forget about it such that if it appears again, we will once more list it to the user.

To illustrate our design, we will break the solution into a number of parts. The first part will be to register a callback function that is called every 30 seconds. This callback will be responsible for requesting a WiFi scan using `wifi_station_scan()`. This takes a callback function which itself will be invoked when the scan is complete.

When the scan completes, we will have a new list of detected networks. We will walk this list and for each network detected, determine if we have seen it before. If we have, we will update the last seen time. If not, we will add it to the list of previously seen networks and log it to the user.

A second timer callback will run once a minute and will walk the list of previously seen networks. If any of them are older than a minute, we will remove them.

See also:

- Scanning for access points

### Sample - A changeable mood light

NeoPixels are LEDs that are driven by a single data line of high speed signaling. Most NeoPixels have a +ve and ground voltage source as well as a data line for input and a data line for output. The output of one NeoPixel can be fed into the input of the next one to produce a string of such LEDs. The input data to the LED is a stream of 24 bits of encoded data which should be interpreted as 8 bits for the red channel, 8 bits for the green channel and 8 bits for the blue channel. Each channel can thus have a luminance value of between 0 and 255. By mixing the values for each of the channels together, you can color an LED to any color you may choose. After sending in a stream of 24 bits, if we send in a second stream of 24 bits quickly after the first stream, the second stream is "pushed" through to the next LED in the chain. This can be repeated as far as desired. If we pause sending in data, the current values are "latched" into place and each LED then remembers its own value.

The timings of the data signals for these LEDs can be quite tricky but fortunately great minds have already built fantastic libraries for driving them correctly so we need not concern ourselves with these low level timings and can instead concentrate on devising interesting projects and purposes to which the LEDs can be placed. There are a number of different types of these LEDs with the most common ones being known as WS2811, WS2812 or PL9823.

Within the Espruino JavaScript environment, a method called `neopixelWrite()` can be found. This takes two parameters. The first is the ESP32 GPIO pin that will be used as the source of the signals to the LEDs. It is to this pin that the LEDs should be wired. The pin used for data output from the ESP32 to the NeoPixels should be set in GPIO output mode. For example:

```
pinMode(pin, "output");
```

The second parameter is an array of integers. The values of the array should be supplied in groups of 3 corresponding to the 3 channels of red, green and blue. For

example, if we had one NeoPixel connected to GPIO4 on an ESP32 and we wanted to set it to all red, we might code:

```
neopixelWrite(new Pin(4), [255, 0, 0]);
```

If we wanted the next pixel to be green while the first is red, we might write:

```
neopixelWrite(new Pin(4), [255, 0, 0, 0, 255, 0]);
```

Again, there is no obvious limit to the number of LEDs we can string together.

Now that we see that we can set the brightness and color of an LED, let us look at how we might design some code to do something. Let us imagine that we had a string of 16 LEDs and wanted to make them the same color ... we might define a function as follows:

```
function colorLeds(red, green, blue) {
  var data = [];
  for (var i=0; i<16; i++) {
    data.push(green);
    data.push(red);
    data.push(blue);
  }
  esp8266.neopixelWrite(NodeMCU.D2, data);
}
```

If we call this function with the correct red, green and blue values, it will set the LEDs string correctly.

Now let us go one step further. Imagine that we received a network REST request that described the color that we want the LEDs to show. A complete application may be:

```
var esp = require("ESP8266");
var NodeMCU = {
  // D0: new Pin(16),
  D1 : new Pin(5),
  D2 : new Pin(4),
  D3 : new Pin(0),
  D4 : new Pin(2),
  D5 : new Pin(14),
  D6 : new Pin(12),
  D7 : new Pin(13),
  D8 : new Pin(15),
  D9 : new Pin(3),
  D10 : new Pin(1)
};
```

```
pinMode(NodeMCU.D2, "output");
```

```
function colorLeds(red, green, blue) {
  var data = [];
  for (var i=0; i<16; i++) {
    data.push(green);
    data.push(red);
    data.push(blue);
  }
}
```

```

    }
    esp.neopixelWrite(NodeMCU.D2, data);
}

function beServer() {
  var http = require("http");
  var httpServer = http.createServer(function(request, response) {
    print(request);
    var partsOfUrl = request.url.split("?");
    if (partsOfUrl.length > 1) {
      var options = partsOfUrl[1].split('&');
      var optionsObj = {};
      for (var i=0; i<options.length; i++) {
        var splitEquals = options[i].split('=');
        optionsObj[splitEquals[0]] = splitEquals[1];
      }
      print("Final obj: " + JSON.stringify(optionsObj));
      if (optionsObj.color !== null) {
        var red = parseInt(optionsObj.color.substr(0,2), 16);
        var green = parseInt(optionsObj.color.substr(2,2), 16);
        var blue = parseInt(optionsObj.color.substr(4,2), 16);
        print("red: " + red + ", green: " + green + ", blue: " + blue);
        colorLeds(red, green, blue);
      }
    }
    print("Result url = " + url);
    response.writeHead(200, {
      "Access-Control-Allow-Origin": "*"
    });
    response.end("");
  }); // End of on new browser request

  httpServer.listen(80);
  print("Now being an HTTP server!");
} // End of beServer

var ssid      = "ssid";
var password = "password";

// Connect to the access point
var wifi = require("wifi");
print("Connecting to access point.");
wifi.connect(ssid, password, null, function(err, ipInfo) {
  if (err) {
    print("Error connecting to access point.");
    return;
  }
  var ESP8266 = require("ESP8266");
  print("Connect says that we are now connected!!!");
  print("Starting web server at http://" + ESP8266.getAddressAsString(ipInfo.ip)
+ ":80");
  beServer();
});

```

When this application runs, it connects to the local WiFi access point and then starts listening for incoming REST requests. A rest request is expected to have a query parameter at the end with the format `color=value` where value is encoded as 6 hex characters corresponding to the color. Finally, we can write a web page that will present a color picker and, when we pick a color, send a REST request to the ESP32 to illuminate the LEDs appropriately. Here is a sample web page to achieve this task:

```
<!DOCTYPE html>
<html>
<head>
<meta charset="ISO-8859-1">
<title>Set LED colors</title>

<link
  href="http://cdnjs.cloudflare.com/ajax/libs/jqueryui/1.11.2/jquery-ui.min.css"
  rel="stylesheet" type="text/css" />
<script
src="http://cdnjs.cloudflare.com/ajax/libs/require.js/2.1.15/require.min.js"></script>
<link rel='stylesheet' href='spectrum.css' />
<script>
  require
    .config({
      baseUrl : "src",
      paths : {
        "jquery" : "http://cdnjs.cloudflare.com/ajax/libs/jquery/2.1.1/jquery.min",
        "jquery-ui" : "http://cdnjs.cloudflare.com/ajax/libs/jqueryui/1.11.2/jquery-
i.min",
      },
      shim : {
        "jquery-ui" : {
          deps : [ "jquery" ],
          exports : 'jQueryUI'
        }
      }
    })
    // End of shims
  });
  require([ "jquery", "spectrum", "jquery-ui" ], function($) {
    $(function() {
      var allowHttp = true;
      $("#flat").spectrum({
        flat : true,
        preferredFormat : "rgb",
        move : function(color) {
          if (allowHttp) {
            allowHttp = false;
            $.ajax({
              url : "http://192.168.1.10",
              data : {
                color : color.toHex()
              },
            },
            success: function() {
              allowHttp = true;
            },
          },
        }
      });
    });
  });
});
```

```

        error: function() {
            allowHttp = true;
        }
    });
}
},
showInput : true,
showButtons : false
});
}); // End of on load
}); // End of require
</script>
</head>
<body>
    <div id="flat" style="width:500px; height: 500px;"></div>
</body>
</html>

```

The end result as seen on the web page looks as follows:

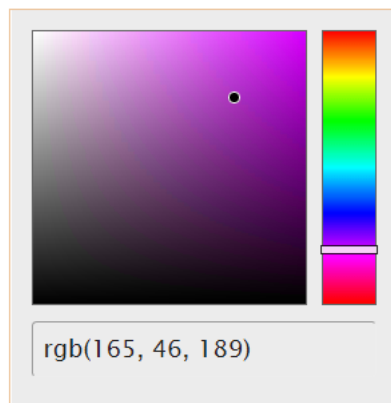

Selecting a new color causes the data to be sent to the ESP32 which colors the LEDs appropriately with the overall end result being the ability to change the mood light of the LED string.

## Using FreeRTOS

When we think of a modern computer, we quickly realize that it has an operating system of some sort. Common examples of these are Microsoft Windows or Linux. The purpose of an operating system is to provide an interface between software applications and the underlying hardware infrastructure. If it wasn't for an operating system, each application would likely have to perform its own similar implementation of such functions which would be a waste. Why not write it once and provide an abstraction layer upon which higher level functions (such as applications) can be built? The capabilities of operating systems on PCs are very similar. They handle memory management,

hardware I/O (reading from keyboards and mice and driving graphics cards), task management (multiple programs running concurrently), disk and file system interactions and much more. Early operating systems provided basic functions while today's operating systems have become richer and richer to the point where they may no longer be considered as just operating systems. Since when did an operating system need to provide Freecell or Minesweeper?

If we rewind the clock and start again and look to the core aspects of an operating system, we come to today's FreeRTOS. FreeRTOS is an open source operating system that provides very basic functions to higher level applications ... again ... the core notion of the purpose of an operating system in the first place. However, FreeRTOS is designed for embedded systems such as the ESP32. It is orders of magnitude simpler than other operating systems such as Linux but this is by design.

FreeRTOS has been ported to a wide variety of hardware platforms including the Xtensa CPUs used in the ESP32. When compiled, it results in a library that is under 5K Bytes in size.

The core functions it provides are:

- memory management
- task management
- API synchronization

The version of FreeRTOS used by the ESP-IDF is 8.2 but with some extra 9.0 features back ported into the version distributed with the ESP-IDF framework.

See also:

- [Free RTOS home page](#)
- [Study of an operating system: FreeRTOS](#)
- Github: [espressif/ESP32\\_RTOS\\_SDK](#)
- [Mastering the FreeRTOS real time kernel](#)

## The architecture of a task in FreeRTOS

Let us start with the notion of a task. A task is a piece of work that we wish to perform. If you wish, you can think of this as a C language function. For example:

```
int add(int a, int b) {  
    return a + b;  
}
```

could be considered a task ... although this would be ridiculously simple. Generically, think of a task as the execution of a piece of C code that you have authored. We normally think of code running from its start all the way through to its end ... however, this is not necessarily the most efficient way to proceed. Consider the idea of an



application which wishes to send some data over the network. It may wish to send a megabyte of data ... however it may also find that it can only send 100K at a time before it has to wait for the transmitted data to be delivered. In that story, it would send 100K and wait for the transmission to complete, send the next 100K and wait for that transmission to complete and so on. But what of those periods of time where the code is waiting for a previous transmission to complete? What is the CPU doing at those times?

The chances are that it is doing nothing but monitoring the flag that states that the transmission has completed. This is a waste. In theory the CPU could be performing other work (assuming that there is in fact other work that could be performed). If there is indeed other work available, we could "context switch" between these work items such that when one blocks waiting for something to happen, control could be passed to another to do something useful.

If we call each piece of work "a task", that is the value of a task in FreeRTOS. The task represents a piece of work to be performed but instead of assuming that the work will quickly go from start to end, we are declaring that there may be times within the work where it can relinquish control to other work (tasks).

This can be illustrated pictorially in the following. First Task A is running and then it either blocks or else is preempted and Task B runs. It runs for a bit and then there is a context switch back to Task A and finally, Task C gets control. At any one time, an individual core is only ever running one task but because of the context switching, we achieve the effect that over some measured time period, ALL the tasks ran.

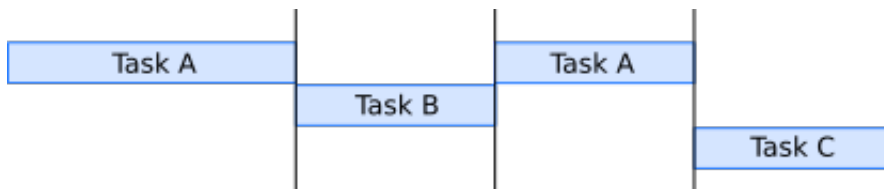

With this in mind, we should think about how a task is created. There is an API provided by FreeRTOS called "`xTaskCreate()`" which creates an instance of a task.

Here it is important to realize that a task is a logical abstraction. There isn't anything specific provided in the CPU that knows what a task is. Instead, it is the operating system (FreeRTOS in our case) that is providing the model of the task for us.

If we think deeply about a task, we can conceive of the task having a state. At any given time, either a task is running or it is not running. A task that is running is one that is actively using the CPU (i.e. not waiting for anything else to happen). A task that is not running is one that doesn't have the CPU. For example, if we created two tasks, one of them would be running and the other not running. If the one that is running reaches a

point where it can no longer perform meaningful work, it will relinquish CPU control and become not running. The other task then has the opportunity to become running.

Going even deeper, when a task is not running, it may be "not running" for a particular reason ... such as:

- Blocked waiting for something to complete
- Suspended by the user
- Ready to run such that when the task that is running is no-longer running, this task is eligible to become running

In FreeRTOS we define a task as a C function that takes a `void *` parameter. For example,

```
void myTask(void *myParameters)
```

might be a signature for a task function.

A task function is expected to run forever. Should it need to end, it should clean itself up before returning by invoking `vTaskDelete()`. This is extremely important. If a task ends without performing this duty, we will receive an exception. Here is an example:

```
Guru Meditation Error: Core 1 panic'ed (IllegalInstruction). Exception was unhandled.
Core 1 register dump:
PC      : 0x400d247b  PS      : 0x00060b30  A0      : 0x00000000  A1      : 0x3ffcaec0
0x400d247b: myTask(void*) at
/home/kolban/esp32/esptest/apps/workspace/watchdog/main/main.cpp:12

A2      : 0x00000000  A3      : 0x00000000  A4      : 0x00000000  A5      : 0x00000000
A6      : 0x00000000  A7      : 0x00000000  A8      : 0x800d247b  A9      : 0x3ffcaea0
A10     : 0x0000000a  A11     : 0x00000000  A12     : 0x00060023  A13     : 0x3ffc62a4
A14     : 0x00000001  A15     : 0x00000001  SAR     : 0x00000000  EXCCAUSE: 0x00000000
EXCVADDR: 0x00000000  LBEG    : 0x400014fd  LEND    : 0x4000150d  LCOUNT : 0xffffffffc

Backtrace: 0x400d247b:0x3ffcaec0 0x7fffffff:0x3ffcaee0
0x400d247b: myTask(void*) at
/home/kolban/esp32/esptest/apps/workspace/watchdog/main/main.cpp:12
```

As you can see, it isn't pretty. Please make sure that your task executes `vTaskDelete()` prior to a return from the task logic.

When a task relinquishes control back to the OS, the OS then may have a choice between multiple other tasks as to which one should become running. This selection process is called "scheduling". FreeRTOS uses the concept of a "priority" to determine which task to run next. Each task that is ready to run is considered a potential candidate and the one that has the highest priority will become the one that is running.

When coding directly to FreeRTOS in non-ESP32 environment, one would normally have to make a call to `vTaskStartScheduler()` to ensure that the task scheduler is operational. This should not be attempted in the ESP32 environment as the internals of

the ESP32 environment have already registered other tasks and already started the scheduler.

- `vTaskDelete`
- `xTaskCreate`
- `xTaskCreatePinnedToCore`
- Watchdog processing
- [YouTube: Tasks and concurrent Sockets](#)

### Priorities and FreeRTOS tasks

When we create a task in FreeRTOS, we can specify the priority of that task. What this means is that if the FreeRTOS task scheduler has a *choice* of a ready to run task to be given control, it will be given to the task with the highest priority. For tasks with the same priority, they are executed in a round-robin fashion.

We can ask a task for its current priority using the function `uxTaskPriorityGet()` and we can change the current priority for a task by calling `vTaskPrioritySet()`.

See also:

- `uxTaskPriorityGet`
- `vTaskPrioritySet`

### Stacks and FreeRTOS tasks

Consider a simple fragment of C code that has a couple of functions:

```
int foo(int a, char b[200]) {
    int c;
    c = bar(a);
    printf("%d %s", c, b);
    return c;
}

int bar(int d) {
    int e;
    e = d * d;
    return e;
}
```

Specifically, I want you to think about the variables in the functions. Hopefully we know that when we create a variable in C that the data that represents the value of the variable is stored in memory. For example, if I define an `"int"` variable, then 4 bytes of storage are required to hold that variable. If I define a variable as `"char[200]"`, then 200 bytes of storage are required to hold the maximum value of the variable. The question I pose to you is "where is the storage for those variables allocated?".

The answer to that question is the idea of a "stack". A stack is a contiguous area of storage that contains the "local" or "contextual" variables of your currently executing function. For example, in the function `foo` shown above, the storage for variables "a", "b" and "c" is created on the stack. Now let us consider what happens when `foo()` calls `bar()`. At the point when `foo()` calls `bar()`, the address of the currently executing state is pushed onto the stack. This is subsequently used to determine where the called function will eventually return to. Next the parameter passed into `bar()` (i.e. "int d") is pushed onto the stack. Finally the storage for variable "e" is pushed onto the stack. Now we pass control to the compiled code that represents the entry point for `bar()`. Note that the stack has "grown" ... this means that the state of the data that was in place for `foo()` has not been lost ... only new storage has been added to provide the context for `bar()`.

When `bar()` eventually returns, the stack allocated storage for the local context is deleted and we return to the stack structure that was in place at the point in `foo()` where we were actually going to call `bar()`. We have "unwound" the stack.

Here are some stack descriptions at different points in the life of our running program.

First here is what the stack looks like within `foo()` just before calling `bar()`.

int a
char b[200]
int c

Next here is what it looks like just after calling `bar()` and while inside the `bar()` function:

int a
char b[200]
int c
return address into foo()
int d
int e

Notice that the stack held values for the function state of `foo()` have not been lost ... they are just further back in the stack.

When eventually the code of `bar()` executes a return, we remove the state of `bar()` from the stack and return control to the address of the code within `foo()` that was the location where we called `bar()`.

int a
char b[200]
int c

This story repeats for arbitrary nested function calls. Each time we call a function, we are creating the local context of that function on the stack and passing control to the target entry point of the function. When the function returns we unwind the stack back to its state at the point of call.

While all this is interesting, it feels a little academic for our work in ESP32s. Do we actually have to know this stuff? The answer is "sort of". In the ESP-IDF framework, we have the concept of "tasks" and each task can be thought of as its own thread of control. This means that, logically, there can be many functions executing in parallel to each other. Now let us map that to what we were just talking about relating to stacks and functions. Each task needs to have its **own** stack storage space. The variables in effect for one task are independent and isolated from the variables in effect for a separate task. Since a task can call arbitrary numbers of functions to an arbitrary depth and the amount and types of data can vary from one function call to another, the compiler doesn't know up-front how big the stack might possibly need to be. Instead, the decision of the amount of space to allocate for a stack for a given task is left to the programmer. If we look at the FreeRTOS API for creating a new task, we see that a parameter defines the amount of space to allocate for a stack for this specific task:

```
BaseType_t xTaskCreate(
    pdTASK_CODE          pvTaskCode,
    const signed portCHAR* pcName,
    unsigned portSHORT   usStackDepth, // <----- Stack size defined here
    void*                pvParameters,
    unsigned portBASE_TYPE uxPriority,
    xTaskHandle*         pxCreatedTask)
```

How big should you make the stack? The answer is a glib "big enough". Look at your application, estimate how much RAM your application needs to execute and then allocate some function of the remainder to the stack.

If you size your stack too low, then the internal operation of the ESP-IDF will fail as it will wish to push more data onto the local task stack than there is space within that stack. The good news is that is "trapped" and your program will stop and report the problem (as opposed to carrying on but broken).

One technique for sizing your stack is to allocate more stack space than you will need. You can then run your application for a while and, when ready, ask the task about its high-water mark of stack usage. This is the maximum amount of stack space that the

task used since it was started. Armed with that information, you can then reduce the amount of stack size you make available.

## Timers in FreeRTOS

There are a number of timer related functions within FreeRTOS that work on the notion of "ticks" where a tick is a unit of time. The default value of the FreeRTOS tick rate is 100 times per second. This can be set in the "make menuconfig" settings found at:

Component config → FreeRTOS → Tick rate (Hz)

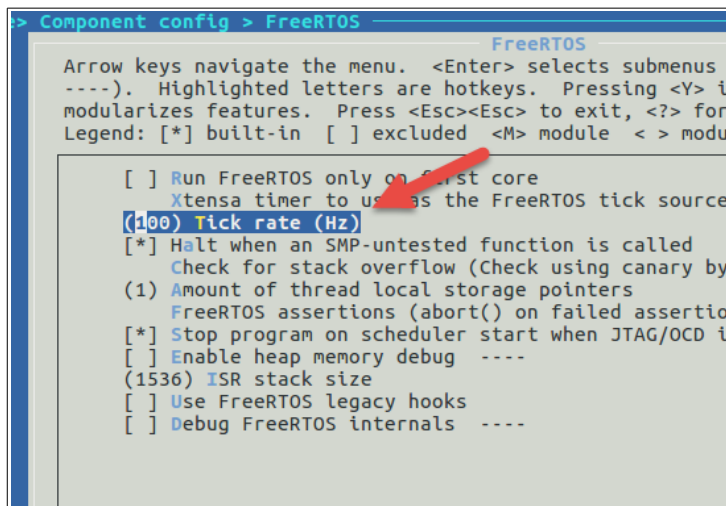

While it seems that the ability to change the value is exposed, I would be wary in doing so. A rate of 100Hz means a tick every 1/100th of a second or every 10msecs.

Rather than think of ticks as absolute numbers, we can think of them as time durations relative to time. The duration of a tick can be specified as `portTICK_PERIOD_MS` which is the duration of a tick in milliseconds. For example, if I need to wait for 1 second (1000 msecs) then I would wait for  $1000 / \text{portTICK\_PERIOD\_MS}$  ticks.

Within FreeRTOS, we can block for a period of time using `vTaskDelay()`. This takes the number of ticks to wait until we unblock. Since the block affects only the current FreeRTOS task, other tasks will continue to be eligible for execution.

See also:

- `xTaskGetTickCount`
- `xTaskGetTickCountFromISR`
- `vTaskDelay`
- `vTaskDelayUntil`

## Blocking and synchronization within FreeRTOS

With the notion of parallel processing tasks within FreeRTOS, we must have a mechanism to synchronize actions between tasks. For example, imagine a task that produces data and a second task that consumes data produced by the first. The producing task must have a mechanism that describes that data has been produced and the consuming task must have a mechanism to block waiting for data to be produced.

One way to achieve this is through the notion of an "event group". Think of an event group as a set of flags that can have the value "0" or "1". A task can set the value of a flag and a second task can be configured to wait (block) until a flag transitions from "0" to "1". What this means is that there is an asynchronous and loosely coupled communication through the use of these flags. From an implementation perspective, FreeRTOS provides a data type called an "event group handle" that is implemented by the opaque data type called "EventGroupHandle\_t". An instance of this is created through a call to `xEventGroupCreate()`. We should assume that that an event group handle can contain a maximum of 8 distinct flags that are identified as 0 through 7 (however, a note states that there may be up to 24 bits available if `configUSE_16_BIT_TICKS` is set to 0). We can set the flags within an event group using `xEventGroupSetBits()` and clear flags using `xEventGroupClearBits()`. Should we need to obtain the values of an event group, we can call `xEventGroupGetBits()`. Simply toggling bits isn't that useful, but we get into the core of the story with the `xEventGroupWaitBits()` function call. When invoked, it causes the caller to be blocked until a named bit or bits becomes set.

For example:

```
static EventGroupHandle_t eventGroup;
#define EVENT_GROUP_SCAN_COMPLETE (1<<0)

void init() {
    eventGroup = xEventGroupCreate();
    xEventGroupClearBits(eventGroup, 0xff);
}

void doSomething() {
    // Start something in the background and wait
    xEventGroupWaitBits(eventGroup,
        EVENT_GROUP_SCAN_COMPLETE,
        1, // Clear on exit
        0, // Wait for all bits
        portMAX_DELAY);
}

void backgroundEventHandler() {
```

```
xEventGroupSetBits(eventGroup, EVENT_GROUP_SCAN_COMPLETE);
}
```

See also:

- `xEventGroupCreate`
- `xEventGroupSetBits`
- `xEventGroupWaitBits`
- [YouTube: ESP32 #25: FreeRTOS – Inter-task Communications – EventGroups](#)

## Semaphores and Mutices within FreeRTOS

When we have multiple tasks executing concurrently, we run the risk of those tasks stepping on each other when it comes to working with shared resources.

Consider the following simple illustrative code:

```
int globalCount;

void add(int value) {
    int temp = globalCount;
    temp = temp + value;
    globalCount = temp;
}
```

It adds a value to a global counter. Imagine the counter starts at 0 and two tasks call `add(2)` at the same time. Logically, after the two tasks complete we want the `globalCount` to equal 4 ... we added 2 and 2 to 0 resulting in 4.

However, consider the interleaved execution as follows:

Task	Statment	Local value of temp	Value of globalCount
Task1	<code>int temp = globalCount</code>	0	0
Task 2	<code>int temp = globalCount</code>	0	0
Task 1	<code>temp = temp + value</code>	2	0
Task 2	<code>temp = temp + value</code>	2	0
Task 1	<code>globalCount = temp</code>	2	2
Task2	<code>globalCount = temp</code>	2	2

and as we can see ... we have ended up with the wrong resulting value. There are excellent books and articles written on "multi-threading" theory and practices and we will not attempt to regurgitate that material here. Instead, we will cut to the chase and introduce the concept of the "Mutex". The name mutex is a shorthand word for "mutual exclusion". It basically states that only one task can be executing in a section of code at a time. An analogy would be the bathroom at a gas station. In order to use the bathroom, I have to get the key from the clerk. If I visit the clerk and ask for the key he will either give it to me or tell me that he doesn't have it because someone else is



already using the bathroom. In the later case, I wait until the other customer finishes and returns the key. At that time the clerk will give me the key and I will go and use the bathroom. While I am using the bathroom, I can be confident that no-one will interrupt me because I am in possession of the key. In this story, the key is an example of the mutex and the bathroom is the shared resource that we are guarding for sole use.

In FreeRTOS, we use the method:

```
SemaphoreHandle_t xSemaphore = xSemaphoreCreateMutex()
```

to create an instance of a mutex.

When we wish to obtain the mutex, we call:

```
xSemaphoreTake(xSemaphore, portMAX_DELAY)
```

This will cause the caller to block indefinitely until the mutex is available.

When we are finished with the task that needs guarded, it is **vital** to call:

```
xSemaphoreGive(xSemaphore)
```

to release the mutex and allow anyone else waiting to continue.

See also:

- xSemaphoreCreateMutex
- xSemaphoreGive
- xSemaphoreTake

## Queues within FreeRTOS

A queue is a data container abstraction. Think of a queue as holding items. When an item is added to a queue, it is added to the end. When an item is removed from a queue, it is removed from the front. This provides a first-in/first-out paradigm. Think of a queue as the line of folks waiting at the department of motor vehicles. Folks join the end of the queue and those that have arrived earlier are serviced sooner.

In FreeRTOS queues, all items on the queue are placed there by copy and not by reference.

When a queue is created, the maximum number of items it can hold is set and fixed at that time. The storage for the queue is also allocated. This means that we can't run out of storage for the queues when adding new items.

The API to create a new queue is:

```
QueueHandle_t xQueueCreate(  
    UBaseType_t uxQueueLength,  
    UBaseType_t uxItemSize)
```

In RTOS we call `xQueueSendToBack()` to add an entry at the end of the queue. The signature of this function is:

```
 BaseType_t xQueueSendToBack(
    QueueHandle_t xQueue,
    const void*   pvItemToQueue,
    TickType_t    xTicksToWait
);
```

The consumer calls `xQueueReceive()` to retrieve the item at the head of the queue. Items in the queue are always stored by copy rather than by reference.

An attempt to receive from an empty queue can cause the caller to block. Conversely, attempting to add an item into a full queue can also cause it to block until space is freed.

The signature of the `xQueueReceive` function looks like:

```
 BaseType_t xQueueReceive(
    QueueHandle_t xQueue,
    void*         pvBuffer,
    TickType_t    xTicksToWait)
```

When we attempt to read an item from the queue and there is no item to read, the call to read will block. We can specify a timeout value measured in ticks. If no new message arrives in that interval, we will return with an indication that no message was retrieved. We can also specify 0 to return immediately if there are no messages. While a task is blocked reading from a queue that task is placed in the blocked state meaning that other tasks can run. This means that we won't be blocking the system while waiting on a queue. When a message arrives, the task that was previously blocked is returned to the ready state and becomes eligible to be executed by the task scheduler.

See also:

- `xQueueCreate`
- `xQueueCreateStatic`
- `vQueueDelete`
- `xQueueOverwrite`
- `xQueuePeek`
- `xQueueReceive`
- `xQueueReset`
- `xQueueSendToBack`
- `xQueueSendToFront`
- [FreeRTOS Queues](#)
- [YouTube: ESP32 #20: FreeRTOS – Inter-task Communication – Queues](#)

## Ring buffer within FreeRTOS

A ring buffer is similar to the notion of a queue with a few major distinctions. Firstly, it is strictly first-in/first-out. There are no options to read from the head of the queue, only

from its tail. In addition, new items can only be added to the head. While the FreeRTOS queues have slots for a fixed number of items of equal size, the ring buffer can hold items with distinct sizes but all the items must exist within a configured size buffer.

To create a ring buffer we call `xRingbufferCreate()` passing in the size of the buffer we wish to allocate (in bytes) as well as how we wish to handle items that may need to wrap-around.

Calls can then be made to insert records of a given length into the buffer using the `xRingbufferSend()` function. Depending on our request and the way the buffer was created, if there is insufficient space in the buffer to insert the record, this call can block for a given period of time or indefinitely until space becomes available.

A consumer that wishes to process records added to the buffer can call `xRingbufferReceive()` to obtain a record if one is available or else block until one does become available or a time interval elapses. It is important to note that a pointer to the storage of the record within the buffer is returned. This means that the record has NOT been removed from the buffer and its space has not yet been reclaimed. When the consumer has received a record and has finished processing it, the consumer should call `xRingbufferReturnItem()` to indicate that it is no longer needed. At that time the storage for it will be released.

- `xRingbufferCreate`
- `xRingbufferReceive`
- `vRingbufferReturnItem`
- `xRingbufferSend`

## Working with queue sets

What if we have multiple source of events such as multiple queues and semaphores? We could poll each one to see if it has data but this isn't efficient. FreeRTOS adds the concept of a "queue set". This is a set of items against which we wish to know when one of them becomes "ready". We use this by creating a queue set by calling `xQueueCreateSet()`. Next we add one or more watchable items using the `xQueueAddToSet()` API as many times as we wish. Now, when ready, we can call `xQueueSelectFromSet()` to ask the set if any of the previously added items are ready to be read from without blocking. Effectively, we can block on all of these items simultaneously and the first one to have data ready for us will be acknowledged.

- `xQueueCreateSet`
- `xQueueAddToSet`
- `xQueueRemoveFromSet`

## Monitoring capabilities

When we run in a FreeRTOS environment, we are allocating resources such as tasks. These run asynchronously with respect to each other. We may wish to know the health and status of these tasks. In a Unix environment, we typically run the "ps" command to look at the set of processes in existence. In Windows, we might run the task manager. In the FreeRTOS environment we have a set of APIs at our disposal to achieve similar tasks.

To get the total number of tasks in the environment, we can call

```
uxTaskGetNumberOfTasks().
```

Once we know the number of tasks, we can retrieve control structures for each of them using `uxTaskGetSystemState()`.

By default, many of the FreeRTOS monitoring functions are disabled. To enable them, we must edit an ESP-IDF supplied header file called

`components/freertos/include/FreeRTOSConfig.h` and find the line which defines the macro `configUSE_TRACE_FACILITY` and set the value to 1. In addition, we must also run `make menuconfig` and change component config -> FreeRTOS -> Halt when an SMP-untested function is called and switch it off:

```

Terminal File Edit View Search Terminal Help
/home/kolban/git/ESP32_Explorer/sdkconfig - Espressif IoT Development Framework Configuration
> Component config > FreeRTOS

FreeRTOS
Arrow keys navigate the menu. <Enter> selects submenus ---> (or empty submenus ----). Highlighted
letters are hotkeys. Pressing <Y> includes, <N> excludes, <M> modularizes features. Press
<Esc><Esc> to exit, <?> for Help, </> for Search. Legend: [*] built-in [ ] excluded <M> module
< > module capable

[*] Run FreeRTOS only on first core
Xtensa timer to use as the FreeRTOS tick source (Timer 0 (int 6, level 1)) --->
(1000) Tick rate (Hz)
[ ] Halt when an SMP-untested function is called
Check for stack overflow (Check by stack pointer value) --->
[ ] Set a debug watchpoint as a stack overflow check
[*] Enable backtrace from interrupt to task context
(3) Number of thread local storage pointers
FreeRTOS assertions (abort() on failed assertions) --->
[*] Stop program on scheduler start when JTAG/OCD is detected
[ ] Enable heap memory debug ----
(1024) Idle Task stack size
(1536) ISR stack size
[ ] Use FreeRTOS legacy hooks
(16) Maximum task name length
[ ] Enable FreeRTOS static allocation API
(1) FreeRTOS timer task priority
(2048) FreeRTOS timer task stack size
(10) FreeRTOS timer queue length
[ ] Debug FreeRTOS internals ----

<Select> < Exit > < Help > < Save > < Load >

```

Note: A new feature appeared in the ESP-IDF that enables this at a higher level. The feature can be found in

Component config -> FreeRTOS -> Enable FreeRTOS trace facility

See also:

- uxTaskGetNumberOfTasks
- uxTaskGetSystemState

## Running untested functions

Some of the FreeRTOS functions have not been tested as fully as necessary to be claimed "supported" by Espressif. What that means is that you should be cautious about using them in your applications. If using them causes failures, Espressif can't assure that a fix will be readily available. By the same token however, there are no known exposed functions that are known *not* to work. Again, this does **not** mean that all functions work, only that we have the absence of information about them. If you do use a function that is not flagged as supported, a run-time assertion will be deliberately thrown to cause you to consider not using that function. If you decide that you do wish to step off the path and use these un-tested functions, you can flag your desire to do so

by changing a configuration flag set by "make menuconfig" within the "Component config → FreeRTOS" settings:

```
[*] Run FreeRTOS only on first core
    Xtensa timer to use as the FreeRTOS tick source (Timer 0 (int 6, level 1)
(1000) Tick rate (Hz)
[ ] Halt when an SMP-untested function is called
    Check for stack overflow (Check by stack pointer value) ---->
(3) Count of thread local storage pointers
    FreeRTOS assertions (abort() on failed assertions) ---->
[*] Stop program on scheduler start when JTAG/OCD is detected
[ ] Enable heap memory debug ----
(1536) ISR stack size
[ ] Use FreeRTOS legacy hooks
[ ] Debug FreeRTOS internals ----
```

## The Serial AT command processor

Serial (UART) connections are one of the simplest ways to communicate directly between two physically close devices. With reasonably high speeds, two devices can connect easily. There are a variety of serial/USB connectors also on the market which means that your PC doesn't need to have a dedicated serial port.

The ESP32 natively supports UART connections meaning that you can connect an ESP32 to your PC and have some application on the PC interact with the ESP32.

Espressif, the makers of the ESP32, have produced a very high level application that can be downloaded and flashed to the device. This application is called the AT Command Processor. Its purpose is to send and receive ASCII serial commands over a serial link and process them. What kinds of commands? The answer is networking commands. This means that the ESP32 can "off-load" networking from other devices. While it would be unlikely you would off-load networking from a PC, other devices such as, for example, an Arduino, could benefit from the simple off-loading of networking with the translation of such command to serial mappings.

See also:

- [ESP32 AT Instruction Set and Examples](#)

## Mongoose OS

Mongoose OS is ...

To install on Linux, run

This will result in the installation of the command called "mos".

The mos command has the following options:

- ui

- init
- build
- flash
- flash-read
- console
- ls
- get
- put
- rm
- config-get
- config-set
- call
- aws-iot-setup
- update
- wifi

When we run mos, it wishes to connect to the ESP32 and needs to know which serial port to use. We can supply this with the "--port <port>" flags. We can also use the MOS\_PORT environment variable to supply a default.

Next we must load the Mongoose OS firmware into the ESP32 using:

```
$ mos flash esp32
```

On my system this took only a few minutes and resulted in the following output:

```
$ ./mos --port /dev/ttyUSB1 flash mos-esp32
Fetching https://mongoose-os.com/downloads/mos-esp32.zip...
Loaded mjs_base/esp32 version 1.0 (20170529-125521/???)
Opening /dev/ttyUSB1...
Connecting to ESP32 ROM, attempt 1 of 10...
  Connected
Running flasher @ 460800...
  Flasher is running
Flash size: 4194304, params: 0x0220 (dio,32m,40m)
Deduping...
  16384 @ 0x9000 -> 12288
  816624 @ 0x10000 -> 746992
Writing...
  16384 @ 0x1000
  4096 @ 0x8000
```

```
8192 @ 0x9000
4096 @ 0xc000
8192 @ 0xd000
4096 @ 0x10000
188416 @ 0x20000
557056 @ 0x50000
131072 @ 0x190000
Wrote 921600 bytes in 20.32 seconds (354.38 KBit/sec)
Verifying...
16320 @ 0x1000
3072 @ 0x8000
16384 @ 0x9000
8192 @ 0xd000
816624 @ 0x10000
131072 @ 0x190000
Booting firmware...
All done!
```

### See also:

- [Mongoose OS home page](#)
- [Mongoose OS Documentation](#)
- [Github: cesanta/mongoose-os](#)

## The Mongoose OS file system

A file system is present within the Mongoose OS. We can access this from the command line using:

- `mos ls` – List files.
- `mos get <file>` – Retrieve the named file.
- `mos put <file>` – Store the named file.

## Setting up Mongoose OS WiFi

Mongoose OS can use the ESP32 WiFi but needs to know the access point SSID and password. We can set this from the command line using:

```
$ ./mos wifi <SSID> <PASSWORD>
```

## Building a Mongoose OS App

Create a directory and run:

```
$ mos init --arch esp32
```

This will populate the current directory with:

- `./mos.yml`
- `./fs`



- ./src/main.c
- ./src/conf\_schema.yaml

## **AWS IoT**

- Device gateway
- Message broker
- Rule engine
- Security and Identity service
- Thing registry
- Thing shadow
- Thing Shadows service

AWS IoT can connect an ESP32 to the AWS IoT servers using MQTT, HTTP or WebSockets protocols. An SDK is available for devices in C, JavaScript, and Arduino.

The target of an ESP32 request is the AWS Device Gateway which is located on the cloud and managed by Amazon.

Each device that can connect to the AWS Device Gateway has a record of its existence stored in the AWS IoT Registry. This registry can store meta data about the device.

A device may not be powered up or it may not be networked connected when a message is to be sent to it. Rather than have to worry about detecting that the message was not delivered, AWS IoT provides the concept of a "device shadow". Think of this as the model of the device as known by the AWS Device Gateway. Your application can request a message to be sent to the device and it is the shadow that remembers this request. When the device does power on and connects to the network, the shadow's state is pushed to the device such that we "eventually" synchronize the desired states.

A component called the Rule Engine can quickly examine data contained in incoming messages sent from the device and routes/processes the request based on the content.

To work with AWS IoT, we work through the AWS IoT Console:

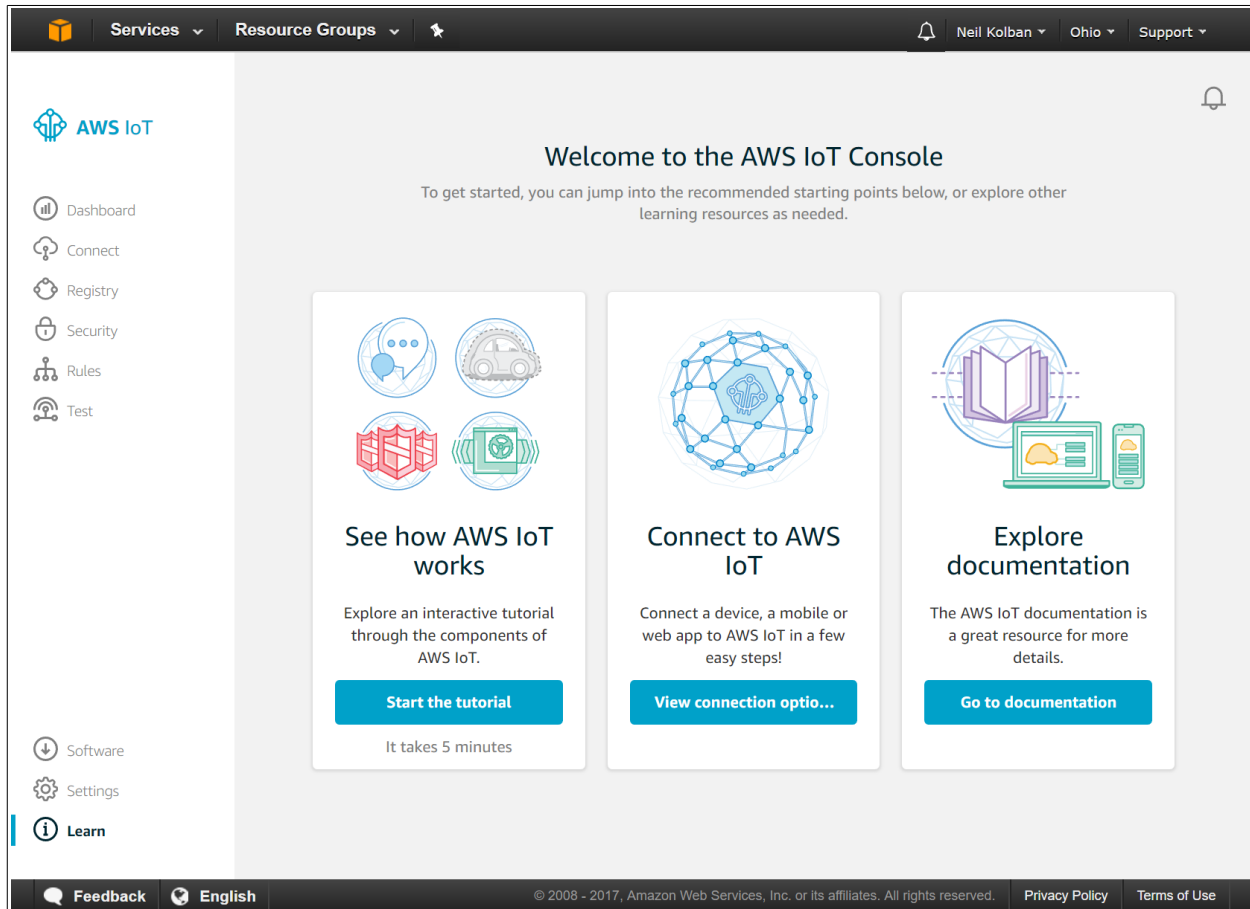

In order for a device to interact with the AWS IoT servers in the cloud, the devices must communicate over a network. To make such communication easier, Amazon has provided a set of SDKs that can be used. These include:

- C-SDK – C programming
- JS-SDK – JavaScript programming
- Java – Java programming
- Python – Python programming
- Mobile SDK – Android and iOS programming

In order for a device to communicate with AWS IoT in the cloud, there must be mutual authentication. This is performed using TLS 1.2. This means that the device will have:

- A private key
- A public certificate

The important concept here is that there is mutual proof of identity. AWS IoT knows the device and trusts that it is who it claims to be and the device knows that it is actually talking to AWS IoT.

Each device has an identity called an "Amazon Resource Name" which is abbreviated to an "ARN". For example:

```
arn:aws:iot:us-east-2:521670688398:thing/ESP32-1
```

See also:

- [AWS IoT – Developers Guide](#)
- [Github: aws/aws-iot-device-sdk-embedded-C](#)
- [Video: Getting started with AWS IoT](#)

## The ESP-IDF `aws_iot` component

The ESP-IDF provides a component that is a pre-cooked mechanism to interact with AWS IoT.

In order to use the package, we need to make available a private key and a certificate. These can be coded into the app or else stored in a partition and read.

In order to connect the ESP32 to the AWS cloud, we need the endpoint of the request associated with your account.

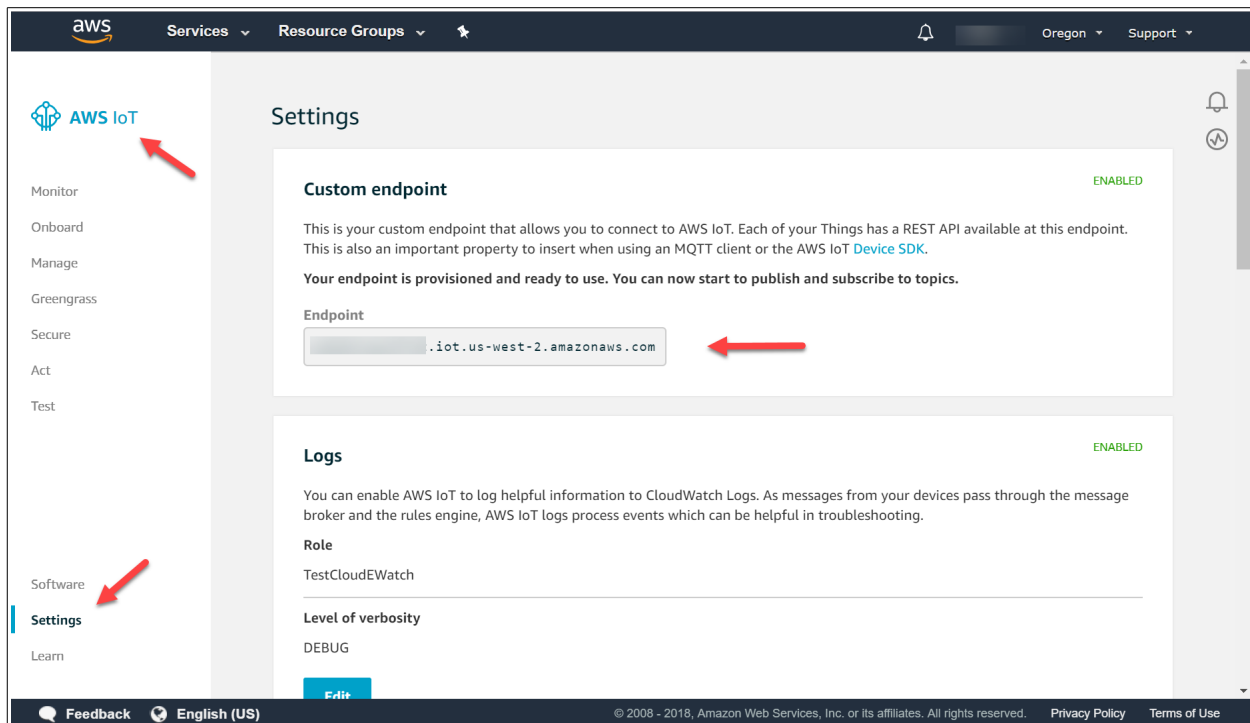

See also:

- [AWS-IoT](#)
- [ESP-IDF AWS IoT Example](#)

## Google IoT

In order to use an ESP32 with Google IoT we must register it as a device in a registry. Before we can register a device, we must have created a registry into which it can be registered.

Communication between the ESP32 and the Google cloud can be over MQTT or HTTP. The communication by the ESP32 is delivered to the Google cloud where it is bridged into the cloud itself. Which protocols you wish to use are defined when the registry is created.

When a connection is formed between the ESP32 and the Google cloud, authentication is performed to ensure that the device request is coming from a legitimate device. To achieve this, we use a public key system. A public/private key pair are generated and the public key given to the registry when the device is registered. The private key is then known only to the device itself.

Every device may have a blob of data known as the device configuration. This is data that can be delivered to the device to allow it to configure itself.

### Creating a Google Cloud IoT device registry

Like most capabilities in GCP, we can define resources using the console, REST or through API.

First we will create a registry.

Once a registry has been created, we will add a device to the registry.

Add a public key.

We can query resources using the command line:

```
$ gcloud iot devices list --region {region} --registry {registry}
```

```
$ gcloud iot devices describe {deviceId} --region {region} --registry {registry}
```

```
$ gcloud iot registries list --region {region}
```

```
$ gcloud iot registries describe {registry} --region {region}
```

### MQTT connections to Google IoT

The Google IoT services has an endpoint at `mqtt.googleapis.com:8883`. When a connection is formed, the device must identify itself using the MQTT client Id. The format of this is:

```
projects/{project-id}/locations/{region}/registries/{registry-id}/devices/{device-id}
```

The topic we are going to publish on must be one of:

- `/devices/{deviceId}/config`
- `/devices/{deviceId}/state`
- `/devices/{deviceId}/events`
- `/devices/{deviceId}/events/otherTopic`

When a device publishes a message, the GCP broker receives the message and redistributes it using Cloud Pub/Sub. The following attributes are added to that message:

- `deviceNumId`
- `deviceId`
- `deviceRegistryLocation`
- `deviceRegistryId`
- `projectId`
- `subFolder`

We can use the MQTT implementation supplied as part of the Espressif Github.

The following `esp_mqtt_client_config_t` properties should be set:

- `client_id` – The encoded client id identifying who we claim to be.
- `username` - "unused"
- `password` – A JSON Web Token.
- `host` – `mqtt.googleapis.com`
- `port` – `8883`
- `transport` – `MQTT_TRANSPORT_SSL`. We wish our communication path to GCP to be over SSL.
- `cert_pem` – The PEM of the CA Cert for GCP.
- `disable_auto_reconnect` – `true`. We want to avoid the situation (especially while developing) that we get into a tight loop attempting to reconnect immediately that we are disconnected. If we get a credential wrong, we want control over how often we retry.

We also need to make changes in through make menuconfig for MQTT connections. Specifically, we need to set the MQTT protocol that is to be used to be 3.1.1 and also enable MQTT over SSL.

See also:

- MQTT

## Using the TI CC2650 SensorTag

The Texas Instruments company makes a device called the CC2650. The device uses an ARM Cortex-M3 processor with a 48MHz clock speed and has 128KB of flash storage. Beyond this processor, there is also the SensorTag kit product.

The device supports multiple networking protocols including:

- BLE
- WiFi
- 6LoWPAN
- ZigBee

When we run up nRF Connect we will see the device with the name CC2650 Sensor Tag:

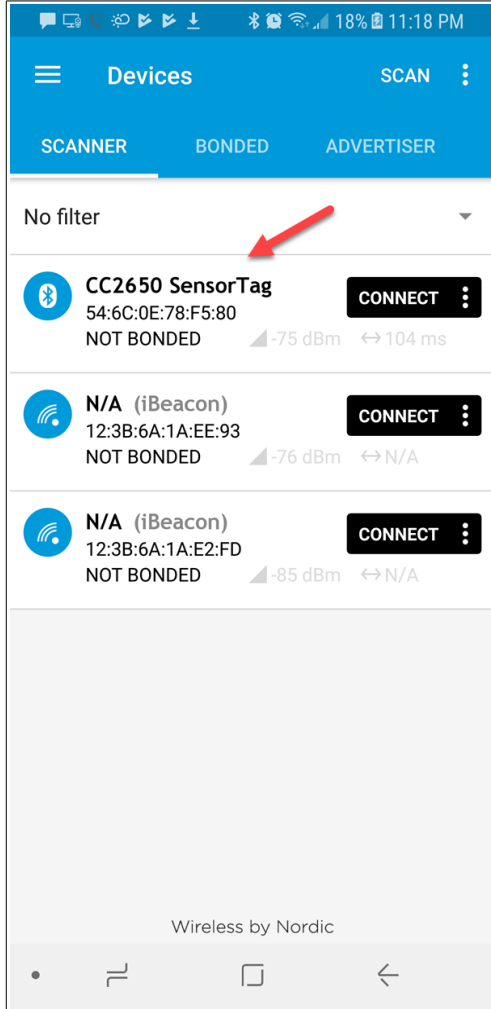

During advertising, we can locate the device from:

- device name: "CC2650 SensorTag"
- service UUID: 0000aa80-0000-1000-8000-00805f9b34fb

Once connected, we will find a number of services at our disposal:

- Generic Access – 0x1800
- Generic Attribute – 0x1801
- Device Information – 0x180a
- Battery Service – 0x180f
- IR Temperature Service – f000aa00-0451-4000-b000-000000000000
  - IR Temperature Data – f000aa01-0451-4000-b000-000000000000

- IR Temperature Config – f000aa02-0451-4000-b000-000000000000
- IR Temperature Period – f000aa03-0451-4000-b000-000000000000
- Humidity Service – f000aa20-0451-4000-b000-000000000000
  - Humidity Data – f000aa21-0451-4000-b000-000000000000
  - Humidity Config – f000aa22-0451-4000-b000-000000000000
  - Humidity Period – f000aa23-0451-4000-b000-000000000000
- Barometer Service – f000aa40-0451-4000-b000-000000000000
  - Barometer Data – f000aa41-0451-4000-b000-000000000000
  - Barometer Config – f000aa42-0451-4000-b000-000000000000
  - Barometer Period – f000aa44-0451-4000-b000-000000000000
- Luxometer Service – f000aa70-0451-4000-b000-000000000000
  - Luxometer Data – f000aa71-0451-4000-b000-000000000000
  - Luxometer Config – f000aa72-0451-4000-b000-000000000000
  - Luxometer Period – f000aa73-0451-4000-b000-000000000000
- Movement Service – f000aa80-0451-4000-b000-000000000000
  - Movement Data – f000aa81-0451-4000-b000-000000000000
  - Movement Config – f000aa82-0451-4000-b000-000000000000
  - Movement Period – f000aa83-0451-4000-b000-000000000000
- 0000dde0-0000-1000-8000-00805f9b34fb
- Simple Keys Service – 0000ffe0-0000-1000-8000-00805f9b34fb
  - Key Press State – 0000ffe1-0000-1000-8000-00805f9b34fb
    - 0x2901 – Characteristic user description "Key Press State"
    - 0x2902 – Client Characteristic Configuration
- IO Service – f000aa64-0451-4000-b000-000000000000
  - IO Data – f000aa65-0451-4000-b000-000000000000
  - IO Config – f000aa66-0451-4000-b000-000000000000
- Register Service – f000ac00-0451-4000-b000-000000000000
  - Register Data – f000ac01-0451-4000-b000-000000000000
  - Register Address – f000ac02-0451-4000-b000-000000000000



- Register Device ID – f000ac03-0451-4000-b000-000000000000
- f000ccc0-0451-4000-b000-000000000000
  - f000ccc1-0451-4000-b000-000000000000 – Connection Parameters
  - f000ccc2-0451-4000-b000-000000000000 – Disconnect Request
  - f000ccc3-0451-4000-b000-000000000000
- f000ffc0-0451-4000-b000-000000000000
  - f000ffc1-0451-4000-b000-000000000000 – OAT Image Identify
    - 0x2901
    - 0x2902
  - f000ffc2-0451-4000-b000-000000000000 – OAT Image Block
    - 0x2901
    - 0x2902
  - f000ffc3-0451-4000-b000-000000000000
    - 0x2901
    - 0x2902
  - f000ffc4-0451-4000-b000-000000000000
    - 0x2901
    - 0x2902

See also:

- [CC2650 home page](#)
- [SensorTag home page](#)
- [SensorTag Teardown](#)
- Wiki - [CC2650 SensorTag User's Guide](#)

## IR Temperature Sensor

The IR temperature sensor uses the TMP007 device. The service is `f000aa00-0451-4000-b000-000000000000`. The characteristics associated with the sensor include:

- IR Temperature Data – `f000aa01-0451-4000-b000-000000000000`

This is a 4 byte value:

Object LSB, Object MSB, Ambient LSB, Ambient MSB

To get the temperature in degrees centigrade we use the following formula:

$$temp = \frac{value}{4} \times 0.03125$$

Since we can read 32 bit values, another algorithm for getting both the object and ambient values is:

```
uint32_t rawValue = pIRTempDataCharacteristic->readUInt32();  
float obj = ((rawValue & 0x0000ffff) >> 2) * 0.03125;  
float amb = ((rawValue & 0xffff0000) >> 18) * 0.03125;
```

- IR Temperature Config – `f000aa02-0451-4000-b000-000000000000`

Enablement control. When set to the value 1, data collection is enabled and when set to 0, disabled.

- IR Temperature Period – `f000aa03-0451-4000-b000-000000000000`

The resolution of reading data from the sensor in multiples of 10msecs. The lowest value that can be specified is 30 (read every 300msecs). The default is to read every 100msecs.

See also:

- [TMP007 Home Page](#)

## Humidity Service

The humidity service is exposed as follows:

- Humidity Service – `f000aa20-0451-4000-b000-000000000000`
  - Humidity Data – `f000aa21-0451-4000-b000-000000000000`
  - Humidity Config – `f000aa22-0451-4000-b000-000000000000`
  - Humidity Period – `f000aa23-0451-4000-b000-000000000000`

The humidity data is composed of 4 bytes encoded as:

TempLSB; TempMSB; Humidity LSB; Humidity MSB

The humidity configuration characteristic controls whether or not humidity data is being processed. A value of 0 means stop/off and a value of 1 means start/on.

The humidity period is how often a new value is read from the humidity/temperature sensor. The period is 10ms \* value. The lower bound is 100ms (hence a value of 10). The default is to read every second (1000ms; hence a value of 100).

## Ambient light sensor

Contained within SensorTag is an OPT3001 lux meter. Within the sensor tag it is exposed as the service with UUID `f000aa70-0451-4000-b000-000000000000`. The characteristics associated with the service include:

- Ambient light data – `f000aa71-0451-4000-b000-000000000000`

This is a two byte value as LSB:MSB.

- Ambient light configuration – `f000aa72-0451-4000-b000-000000000000`

This is a byte value with encoding of 0 as disabled and 1 as enabled.

- Ambient light period – `f000aa73-0451-4000-b000-000000000000`

This is the sample rate of the sensor defined a value \* 10msecs as the period with a lower limit value of 1000ms (a value of 100). The default is to sample every 2000ms (a value of 200).

See also:

- [OPT3001 – Home page](#)
- [OPT3001 – Datasheet](#)

## Key Press

Contained within SensorTag is a reed switch. This is a switch which is activated by the presence of a magnetic field (a magnet). By bringing a magnet near SensorTag we can trip the switch. In addition to the magnetically operated reed switch, the SensorTag has two buttons (one on each side of the device). If pressed, these can also be used as triggers. The Key Press service has one characteristic which is notification only (no read or write). When a trigger is detected, a byte is published which has bit flags set:

- bit 0 – True if the left key (user app button) is pressed
- bit 1 – True if the right key (power button) is pressed
- bit 2 – True if the reed switch (magnetic switch) is activated

Service UUID: `0000ffe0-0000-1000-8000-00805f9b34fb`

Characteristic UUID (Key Press State): `0000ffe1-0000-1000-8000-00805f9b34fb`

See also:

- [MK24 Reed Sensor – Home Page](#)
- [MK24 Reed Sensor – Data Sheet](#)

## Developing solutions on Linux

When working in a Linux environments, there are certain tips and techniques which might be useful/valuable.

- When connecting to an ESP32 board using a USB→UART connector, the device may show up under `/dev` as `ttUSB0`. If we examine the permissions upon this file, we may find that it is configured as:

```
crw-rw---- root dialout
```

This means that it is accessible by root and users in the `dialout` group. If you wish to flash the ESP32 through this device, your userid should thus be a member of this group. To add your user to the group, the following Linux command may be used:

```
sudo usermod -a -G dialout <yourUserId>
```

after making the change, you must log out and log back in again.

- A useful terminal client is `GtkTerm`. This tool provides a terminal viewer that can be used to monitor the USB→UART connector to view log and debug messages. It creates a configuration file in `$HOME/.gtktermrc` that can be edited to change the default serial port (eg. `/dev/ttyUSB0`) as well as changing the baud rate to your desired value.
- Another good terminal client is `screen`. Screen is a full screen terminal emulator.
- Yet another terminal client is the classic `cu` command. Again, very easy to use. An example of use would be:

```
$ cu --line /dev/ttyUSB0 --speed 115200
```

To quit a `cu` session, enter "`~.`".

### Building a Linux environment

If you don't run Linux natively you may wish to consider running Oracle VirtualBox to host a Linux environment on your Windows or Mac machine. Oracle VirtualBox is an Open Source implementation of an operating system virtualization product. One can download VirtualBox from here:

<https://www.virtualbox.org/>

In my tests, I ran Ubuntu 15.10.

I define a disk size of at least 20GBytes and 2GBytes of RAM. If you have multiple cores, you may want to define those as being available.

After building an image, make sure that you enable the ability to copy and paste between the host OS and the guest OS.

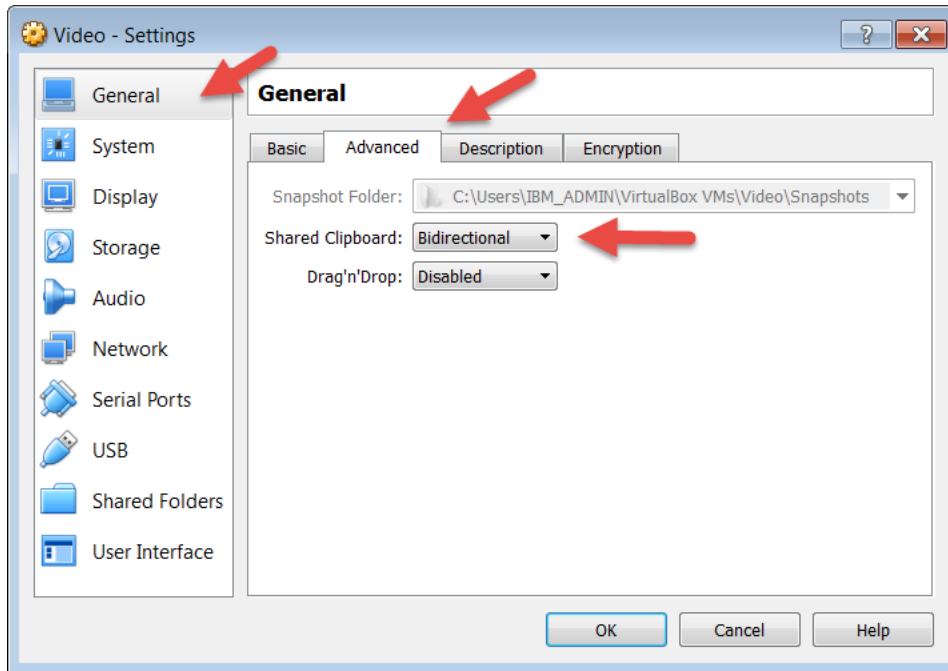

Also make sure that the VirtualBox guest tools are installed.

There are some packages that you really can't do without including:

- git

You can install new packages with:

```
sudo apt-get install <package>
```

Once you have a Linux OS installed, next we want to build a compilation environment.

I would also install:

- [Chrome](#)

See also:

- [Oracle Virtual Box](#)
- [Ubuntu downloads](#)

## Hardware architecture

The majority of this book describes programming the device at the software level through driver libraries. However, let us take a step back. The ESP32 is a low-level hardware component. It is basically a low level System On a Chip (SOC) device.

### The CPU and cores

There are two cores within the ESP32 CPU named "PRO" and "APP".

### Intrinsic data types

When we program in C, we are programming pretty close to the metal of the environment. Data type sizes and other considerations can and do come into consideration. Let us now examine the data sizes of some of the core types:

Type	Size (bytes)	Size (bits)
short	2	16
int	4	32
long	4	32
long long	8	64
int64_t	8	64
float	4	32
double	8	64

### Native byte order, endian and network byte order

The ESP32 is a "little endian" architecture.

When we wish to represent a number, for example 9876 (in decimal) we find that it will not fit in a single byte since a byte can hold only 8 bits of data and hence has a value from 0-255. As such, we need to split it across multiple bytes. If we think of two bytes, that is 16 bits of information and hence can represent a number from 0-65535. When we think of a 16 bit number we can think of that as two 8 bit numbers such that the result is  $a * 256 + b$ . For example 9876 is  $38 * 256 + 148 \dots$  and in our equation  $a=38$  and  $b=148$ . No great mystery yet. Now we can see that a 16 bit number can be represented by two distinct 8 bit numbers. Now imagine a piece of memory where we wish to store our 16 bit number. We can immediately see that we will store our 16 bit number as two consecutive bytes. One byte representing "a" and one representing "b". The question becomes should we store "a" then "b" or "b" then "a"? From an underlying technical perspective both are equally valid ... however we need to be consistent across our architecture. Storing "a" then "b" is called a "big endian" architecture while storing "b" then "a" is called a "little endian" architecture"

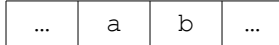

or



Here is a simple program fragment to test for ourselves what is in play in the ESP32 environment:

```
char* p = malloc(2);
*(unsigned short*)p = (unsigned short)9876;
printf("low: %d high %d\n", *(p), *(p+1));
```

And when we run, the result is:

```
low: 148 high 38
```

Showing that the byte ordering for storing integers is "little endian". This concept becomes exceptionally important when reading binary data that was written on a different system. If we do not handle this correctly, we can interpret data in an incorrect fashion. For example  $38 * 256 + 148$  is a very different number from  $38 + 148 * 256$ .

Note that network data transport uses big endian format which means that the data format for native data on an ESP32 is **not** the same format as network byte order which means that we **must** transform data using `htons()`, `htonl()`, `ntohs()` and `ntohl()`.

A more precise terminology for byte ordering uses the phrases "Most Significant Byte" and "Least Significant Byte". With big endian encoding, the most significant byte is first while with little endian, the least significant byte is first.

## Memory mapping and address spaces

When we program to the APIs exposed by Espressif provided libraries, we are taking advantage of the higher level APIs and internals that they expose. But let us now contemplate how those libraries work and what we can do with that knowledge.

As a SOC, there is a processor (well, actually two of them), RAM and an address space. Being a 32 bit processor, the address space of the ESP32 is 32 bits in length. This means that, in theory, an application can read or write a byte at memory location `0x0000 0000` or `0xffff ffff` or any address in between. At the hardware mapping level, some of these addresses are mapped to RAM, some to an internal ROM, some to

peripherals and some to flash memory. By consulting the ESP32 Technical Reference manual, we can start to learn more.

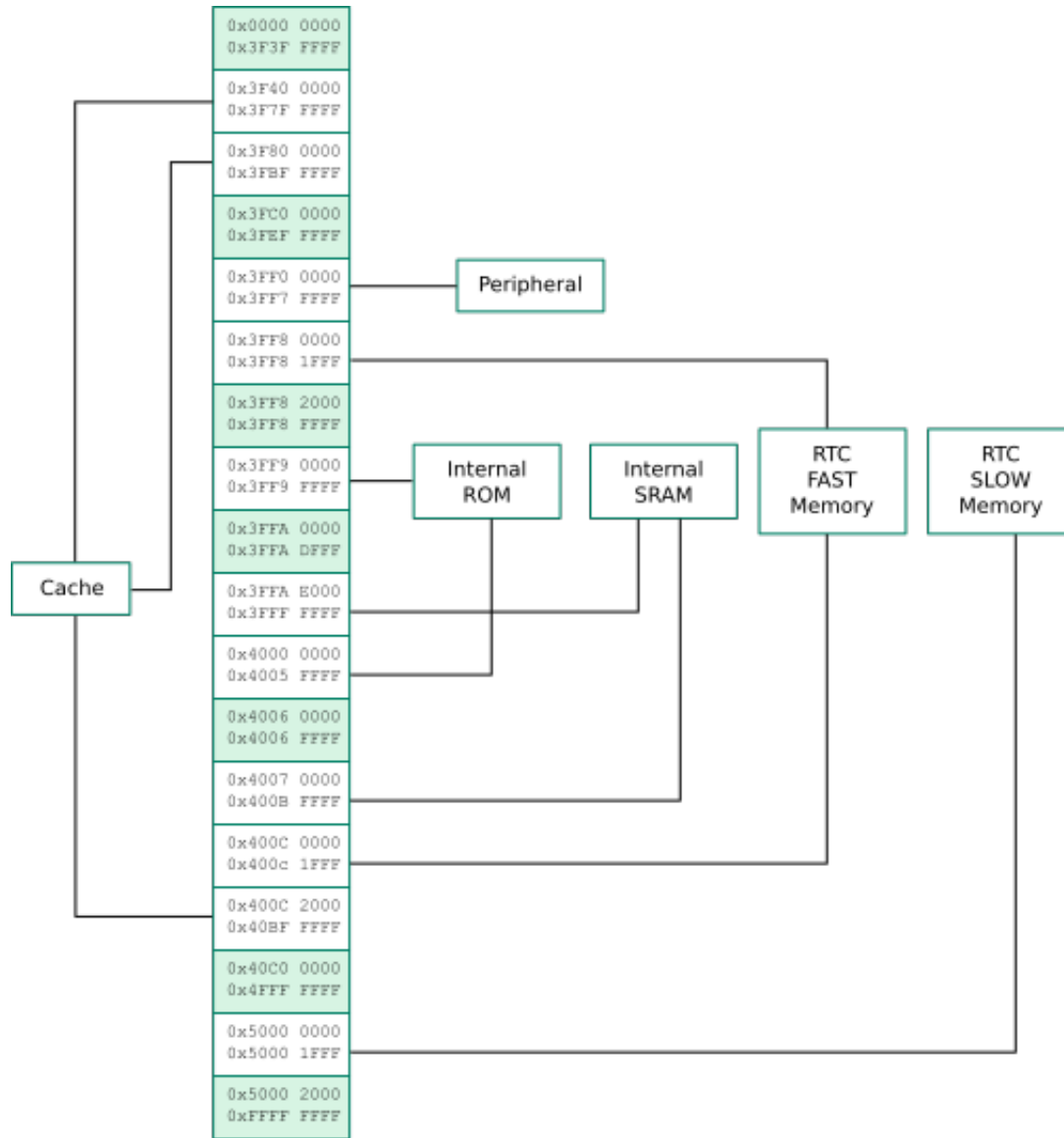

Within the ESP32 there are four segments of internal memory:

- ROM – 448KB – Read only memory with the content provided by Espressif.
- SRAM – 520KB – Internal RAM that is supplied inside the ESP32.
- RTC FAST – 8KB
- RTC SLOW – 8KB

There is also external memory. This is memory that can be addressed but that is provided by components outside of the ESP32 IC itself such as SPI flash or SPI ram.



The architecture of an ESP32 is called the "Harvard Architecture" and we need to explain that a bit more. When we think of a classic architecture, we usually think of the existence of a memory bus that reads and writes from RAM based storage. Both instructions and data can be found in the memory. The CPU retrieves the next instruction by requesting the data at a specific RAM address. When the instruction is retrieved, the CPU executes the instruction which may read or write data at other addresses in RAM. When the instruction completes, the story repeats for the next instruction.

The Harvard Architecture introduces a second memory bus. The thinking is that RAM will either be used to hold instructions to be executed or will hold data to be manipulated. By separating RAM into these two categories, a number of interesting things start to happen. Instructions are read from the instruction bus and data is read and written from the data bus. The actual RAM at the ends of these buses is now categorized by function. We have IRAM for RAM that holds instructions to be executed and we have DRAM for RAM that holds data.

We can catch a badly behaving application should it try and write into the instruction area of RAM. Since this bus is considered (for the most part) read only, the hardware can detect and trap invalid access.

A second benefit of having two buses is that during the execution of an instruction, the next instruction can be started to be read without impacting access to any data needing to be accessed by the current instruction as that access will be happening over the data bus. Effectively this allows us to perform certain operations in parallel and allows us to perceive an increase in performance.

## Reading and writing registers

We can read the value of a peripheral register using the macro `READ_PERI_REG(name)`. This is defined in `<soc/soc.h>`.

Field names ending in `_S` are shift values.

- `REG_WRITE`
- `REG_READ`
- `REG_GET_BIT`
- `REG_SET_BIT`
- `REG_CLR_BIT`
- `REG_SET_BITS`

- REG\_GET\_FIELD
- REG\_SET\_FIELD
- VALUE\_GET\_FIELD
- VALUE\_GET\_FIELD2
- VALUE\_SET\_FIELD
- VALUE\_SET\_FIELD2
- FIELD\_TO\_VALUE
- FIELD\_TO\_VALUE2
- READ\_PERI\_REG
- WRITE\_PERI\_REG – Write to a peripheral register. The first parameter is a register identifier and the second is the value.
- CLEAR\_PERI\_REG\_MASK – Clear the bits of a peripheral register. The first parameter is a register identifier and the second is a mask where a 1 bit means to clear.
- SET\_PERI\_REG\_MASK – Set the bits of a peripheral register. The first parameter is a register identifier and the second is a mask where a 1 bit means to set,
- GET\_PERI\_REG\_MASK – Get the bits of a peripheral register. The first parameter is a register identifier and the second is a mask used to include/exclude the result.
- GET\_PERI\_REG\_BITS – Get the bits of a peripheral register. The first parameter is a register identifier and the next two are hi and low positions to return.
- SET\_PERI\_REG\_BITS – Set the bits of a peripheral register. The first parameter is a register identifier, the next is a bitmap, the next is a value and the final is a shift value.

```
SET_PERI_REG_BITS(reg, bit_map, value, shift)
```

Example:

```
SET_PERI_REG_BITS(SOME_REG, SOME_FIELD, value, SOME_FIELD_S)
```

- GET\_PERI\_REG\_BITS2

## Pads and multiplexing

A pad is an externalized input or output on the ESP32 device. The ESP32 has a total of 40 pads but only a subset of them are exposed. Within the ESP32 there is a logical component called the "IO\_MUX". This is an "Input/Output Multiplexer". In English imagine this as a logical "switch board" with some fixed number of actual telephones attached to it. When caller wishes to communicate with a telephone, it has to pass through the IO\_MUX which decides which physical telephone to pass the call to. This means that there is a separation between logical "calls" and physical "phones".

- Pads 0-39 can be input
- Pads 0-33 can be output

GPIO	Pad Name	Function 1	Function 2	Function 3	Function 4	Function 5	Function 6
0	GPIO0	GPIO0	CLK_OUT1	GPIO0			
1	U0TXD	U0TXD	CLK_OUT3	GPIO1			
2	GPIO2	GPIO2	HSPIWP	GPIO2	HS2_DATA0	SD_DDATA0	
3	U0RXD	U0RXD	CLK_OUT2	GPIO3			
4	GPIO4	GPIO4	HSPIHD	GPIO4	HS2_DATA1	SD_DATA1	
5	GPIO5	GPIO5	VSPICS0	GPIO5	HS1_DATA6		
6	SD_CLK	SD_CLK	SPICLK	GPIO6	HS1_CLK	U1CTS	
7	SD_DATA_0	SD_DATA_0	SPIQ	GPIO7	HS1_DATA0	U2RTS	
8	SD_DATA_1	SD_DATA_1	SPID	GPIO8	HS1_DATA1	U2CTS	
9	SD_DATA_2	SD_DATA_2	SPIHD	GPIO9	HS1_DATA2	U1RXD	
10	SD_DATA_3	SD_DATA_3	SPIWP	GPIO10	HS1_DATA3	U1TXD	
11	SD_CMD	SD_CMD	SPICS0	GPIO11	HS1_CMD	U1RTS	
12	MTDI	MTDI	HSPIQ	GPIO12	HS2_DATA2	SD_DATA2	
13	MTCK	MTCK	HSPID	GPIO13	HS2_DATA3	SD_DATA3	
14	MTMS	MTMS	HSPICLK	GPIO14	HS2_CLK	SD_CLK	
15	MTDO	MTDO	HSPICS0	GPIO15	HS2_CMD	SD_CMD	
16	GPIO16	GPIO16		GPIO16	HS1_DATA4	U2RXD	
17	GPIO17	GPIO17		GPIO17	HS1_DATA5	U2TXD	
18	GPIO18	GPIO18	VSPICLK	GPIO18	HS1_DATA7		
19	GPIO19	GPIO19	VSPIQ	GPIO19	U0CTS		
20	GPIO20	GPIO20		GPIO20			
21	GPIO21	GPIO21	VSPIHD	GPIO21			
22	GPIO22	GPIO22	VSPIHD	GPIO22	U0RTS		
23	GPIO23	GPIO23	VSPID	GPIO23	HS1_STROBE		
24							
25	GPIO25	GPIO25		GPIO25			

26	GPIO26	GPIO26		GPIO26			
27	GPIO27	GPIO27		GPIO27			
28							
29							
30							
31							
32	32K_XP	GPIO32		GPIO32			
33	32K_XN	GPIO33		GPIO33			
34	VDET_1	GPIO34		GPIO34			
35	VDET_2	GPIO35		GPIO35			
36	SENSOR_VP	GPIO36		GPIO36			
37	SENSOR_CAPP	GPIO37		GPIO37			
38	SENSOR_CAPN	GPIO38		GPIO38			
39	SENSOR_VN	GPIO39		GPIO39			

Now let us think of the "things" that wish to read and write from these pad pins. Some of them need to be really fast while others can afford to be slower. For the fast ones, we say that these need direct I/O. Examples of fast components include Ethernet, SDIO, SPI, JTAG and UART. The other ones we say are GPIO based and can be used by slower functions. Examples of these include I2C, I2S, PWM, LEDC and others.

Schematically, this might look as follows:

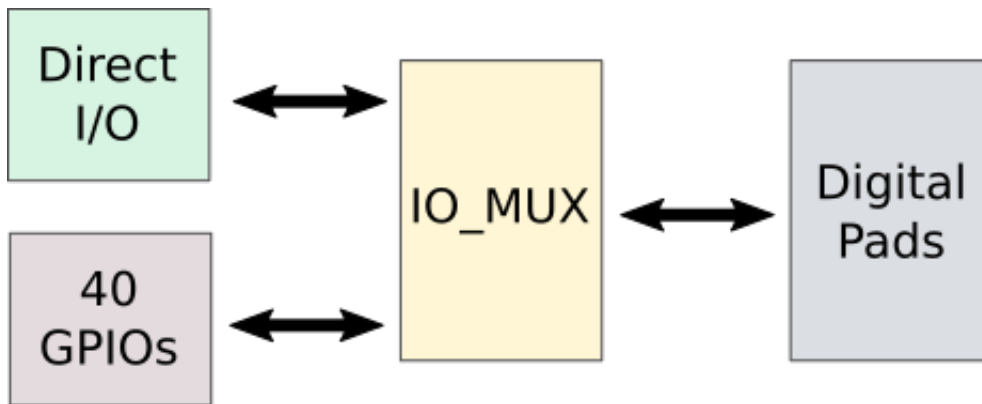

What this means is that input/output from the digital pads is governed directly by the IO\_MUX controller. Each of the 40 digital pads can be thought of as having a control register that says "For a given pad, is this pad connected to GPIO or is it connected to a Direct I/O device and, if a direct I/O device ... which one?".

Now let us add another twist. There is the concept of a "signal". Think of a signal as being either output from an internal component or input from an internal component. We can map a signal to a GPIO for input or output. This effectively allows us to matrix map anything to anything. In the following diagram, we show this component.



To say that a signal will appear on a particular GPIO, we execute the following logic:

```
PIN_FUNC_SELECT(GPIO_PIN_MUX_REG[gpioNum], PIN_FUNC_GPIO);
gpio_set_direction(gpioNum, GPIO_MODE_OUTPUT);
gpio_matrix_out(gpioNum, signal, 0, 0);
```

What we do is say that a particular pad (PIN) is going to be used for GPIO which means that its data will come from a signal as opposed to direct I/O. Then we say that a particular signal is mapped to a GPIO.

See also:

- `gpio_matrix_out`
- `gpio_set_direction`

## Register based GPIO

There are 34 usable GPIO pins on the ESP32. We should also remember that there are 40 pads on an ESP32. Some of the GPIOs are in the 0-31 pad range and some in the 32-39 pad range. Since the ESP32 is a 32bit processor, this means that a single register can only hold 32 bits of information. As such, we have pairs of registers for working with GPIO functions. The first in the pair corresponds to GPIOs on pads 0-31 and the second on pads 32-39.

The registers called `GPIO_ENABLE_REG` (0-31) and `GPIO_ENABLE1_REG` (32-39) control whether or not a GPIO is input or output. If the corresponding bit is high then the GPIO is output while if it is low then the GPIO is input.

When working with GPIO, there are registers that we can use as follows:

- Setting a bit in a register causes the output value of the corresponding GPIO to be high
- Setting a bit in a register causes the output value of the corresponding GPIO to be low

An individual GPIO pin can be defined as either input or output. Input means we can read the signal present on that pin. Output means that we can set the signal that is

present on the pin. A GPIO can be *either* input or output at a given time but, obviously, can not be both.

A very useful data structure is defined in `soc/gpio_struct.h`. The type of the structure is called `gpio_dev_t` and it is exposed via the global GPIO. It contains:

	bt_select	
GPIO_OUT_REG	out	GPIO 0-31 output
GPIO_OUT_W1TS_REG	out_w1ts	GPIO 0-31 set
GPIO_OUT_W1TC_REG	out_w1tc	GPIO 0-31 clear
GPIO_OUT1_REG	out1	GPIO 32-39 output
GPIO_OUT1_W1TS_REG	out1_w1ts	GPIO 32-39 set
GPIO_OUT1_W1TC_REG	out1_w1tc	GPIO 32-39 clear
	sdio_select	
GPIO_ENABLE_REG	enable	GPIO 0-31 output enable
GPIO_ENABLE_W1TS_REG	enable_w1ts	GPIO 0-31 output set
GPIO_ENABLE_W1TC_REG	enable_w1tc	GPIO 0-31 output clear
GPIO_ENABLE1_REG	enable1	GPIO 32-39 output enable
GPIO_ENABLE1_W1TS_REG	enable1_w1ts	GPIO 32-39 output set
GPIO_ENABLE1_W1TC_REG	enable1_w1tc	GPIO 32-39 output clear
GPIO_STRAP_REG	strap	Boot strapping input data
GPIO_IN_REG	in	GPIO 0-31 input
GPIO_IN1_REG	in1	GPIO 32-39 input
GPIO_STATUS_REG	status	GPIO 0-31 interrupt status
GPIO_STATUS_W1TS_REG	status_w1ts	GPIO 0-31 interrupt status set
GPIO_STATUS_W1TC_REG	status_w1tc	GPIO 0-31 interrupt status clear
GPIO_STATUS1_REG	status1	GPIO 32-39 interrupt status
GPIO_STATUS1_W1TS_REG	status1_w1ts	GPIO 32-39 interrupt status set
GPIO_STATUS1_W1TC_REG	status1_w1tc	GPIO 32-39 interrupt status clear
	acpu_int	GPIO 0-31 APP CPU interrupt status
	acpu_nmi_int	GPIO 0-31 APP CPU non-maskable interrupt status
	pcpu_int	GPIO 0-31 PRO CPU interrupt status
	pcpu_nmi_int	GPIO 0-31 PRO CPU non-maskable interrupt status
	cpusdio_int	
	acpu_int1	
	acpu_nmi_int1	
	pcpu_int1	
	pcpu_nmi_int1	
	cpusdio_int1	
	pin[]	
	cali_conf	
	cali_data	

GPIO_FUNCm_IN_SEL_CFG_REG	func_in_sel_cfg[]	
GPIO_FUNCn_OUT_SEL_CFG_REG	func_out_sel_cfg	

## IO\_MUX\_x\_REG

x is 0 to 39.

IO_x_MCU_SEL	Select the IO_MUX function.
IO_x_FUNC_DRV	Drive strength of the pad
IO_x_FUNC_IE	Input Enable of the pad.
IO_x_FUNC_WPU	Internal pull-up.
IO_x_FUNC_WPD	Internal pull-down.
IO_x_MCU_DRV	Drive strength in sleep mode.
IO_x_MCU_IE	Input enable during sleep mode.
IO_x_MCU_WPU	Internal pull-up during sleep mode.
IO_x_MCU_WPD	Internal pull-down during sleep mode.
IO_x_SLP_SEL	Sleep mode selection.
IO_x_MCU_OE	Output enable in sleep mode.

## IO\_x\_MCU\_SEL

## GPIO\_OUT\_REG

C Struct: GPIO.out

The values of the output signal on GPIO pins 0-31.

## GPIO\_OUT\_W1TS\_REG

C Struct: GPIO.out\_w1ts

W1TS is Write One To Set. Setting the corresponding bit to 1, cause the GPIO output to be 1.

## GPIO\_OUT\_W1TC\_REG

C Struct: GPIO.out\_w1tc

W1TC is Write One To Clear. Setting the corresponding bit to 1, cause the GPIO output to be 0.



### **GPIO\_OUT1\_REG**

C Struct: GPIO.out1.data, GPIO.out1.val

The values of the output signal on GPIO pins 32-39.

### **GPIO\_OUT1\_W1TS\_REG**

C Struct: GPIO.out1\_w1ts.data, GPIO.out1\_w1ts.val

W1TS is Write One To Set. Setting the corresponding bit to 1, cause the GPIO output to be 1.

### **GPIO\_OUT1\_W1TC\_REG**

C Struct: GPIO.out1\_w1tc.data, GPIO.out1\_w1tc.val

W1TC is Write One To Clear. Setting the corresponding bit to 1, cause the GPIO output to be 0.

### **GPIO\_ENABLE\_REG**

C Struct: GPIO.enable

The enable register is oddly named. It defines whether or not a pin will be output or input. If the corresponding bit is 1, the pin will be output while if the corresponding bit is 0, the pin will be input. This register covers pins 0-31.

### **GPIO\_ENABLE\_W1TS\_REG**

C Struct: GPIO.enable\_w1ts

### **GPIO\_ENABLE\_W1TC\_REG**

C Struct: GPIO.enable\_w1tc

### **GPIO\_ENABLE1\_REG**

C Struct: GPIO.enable1.data, GPIO.enable1.val

The enable register is oddly named. It defines whether or not a pin will be output or input. If the corresponding bit is 1, the pin will be output while if the corresponding bit is 0, the pin will be input. This register covers pins 32-39.

#### **GPIO\_ENABLE1\_W1TS\_REG**

C Struct: GPIO.enable\_w1ts.data, GPIO.enable\_w1ts.val

#### **GPIO\_ENABLE1\_W1TC\_REG**

C Struct: GPIO.enable\_w1tc.data, GPIO.enable\_w1tc.val

#### **GPIO\_STRAP\_REG**

C Struct: GPIO.strap.strapping, GPIO.strap.val,

The values of strapping pins at boot:

MTDI, GPIO0, GPIO2, GPIO4, MTDO, GPIO5

#### **GPIO\_IN\_REG**

C Struct: GPIO.in

The values of the input signal on GPIO pins 0-31. This is a read only register. It makes no sense to try and change the value of the register that reflects the current value found on the pins.

#### **GPIO\_IN1\_REG**

C Struct: GPIO.in1.data, GPIO.in1.val

The values of the input signal on GPIO pins 32-39. This is a read only register. It makes no sense to try and change the value of the register that reflects the current value found on the pins.

#### **GPIO\_STATUS\_REG**

C Struct: GPIO.status

**GPIO\_STATUS\_W1TS\_REG**  
C Struct: GPIO.status\_w1ts

**GPIO\_STATUS\_W1TC\_REG**  
C Struct: GPIO.status\_w1tc

**GPIO\_STATUS1\_REG**  
C Struct: GPIO.status1.intr\_st, GPIO.status1.val

**GPIO\_STATUS1\_W1TS\_REG**  
C Struct: GPIO.status1\_w1ts.intr\_st, GPIO.status1\_w1ts.val

**GPIO\_STATUS1\_W1TC\_REG**  
C Struct: GPIO.status1\_w1tc.intr\_st, GPIO.status1\_w1tc.val

**GPIO\_PCPU\_NMI\_INT1\_REG**

**GPIO\_PCPU\_NMI\_INT1\_REG**

**GPIO\_PINn\_REG**

C Struct: GPIO.pin[m]

```
#include <soc/gpio_struct.h>
```

m is 0 to 39

Fields	Bits	Struct field
GPIO_PINn_INT_ENA	[17:13]	GPIO.pins[n].int_ena
GPIO_PINn_WAKEUP_ENABLE	[10]	GPIO.pins[n].wakeup_enable
GPIO_PINn_INT_TYPE	[9:7]	GPIO.pins[n].int_type
GPIO_PINn_PAD_DRIVER	[2]	GPIO.pins[n].pad_driver

The `GPIO_PINn_INT_ENA` defines whether or not this pin is enabled to generate interrupts.

The `GPIO_PINn_WAKEUP_ENABLE` defines whether or not this pin can wake up the CPU in light sleep mode.

The `GPIO_PINn_INT_TYPE` defines the type of interrupt trigger.

The `GPIO_PINn_PAD_DRIVER` defines the type of output. Choices are normal or open drain.

### GPIO\_FUNCm\_IN\_SEL\_CFG\_REG

**C Struct:** `GPIO.func_in_sel_cfg[m]`

```
#include <soc/gpio_struct.h>
```

`m` is 0 to 255.

There are 256 different possible functions. There is a register for each of the functions. The register defines which of the 40 GPIOs is mapped as input to that function signal.

The field `GPIO_FUNCm_IN_SEL` defines the GPIO pad for the corresponding function. This will be 0-39 for the pads with special values of `0x38` for always high and `0x30` for always low.

If we want to invert the incoming signal, we can set the `GPIO_FUNCm_IN_INV_SEL` field to 1.

If we wish to bypass the GPIO matrix, set the `GPIO_SIGm_IN_SEL` to 1.

Field	Bits	Struct field
<code>GPIO_SIGm_IN_SEL</code>	[7]	<code>GPIO.func_in_sel_cfg[n].sig_in_sel</code>
<code>GPIO_FUNCm_IN_INV_SEL</code>	[6]	<code>GPIO.func_in_sel_cfg[n].sig_in_inv</code>
<code>GPIO_FUNCm_IN_SEL</code>	[5:0]	<code>GPIO.func_in_sel_cfg[n].func_sel</code>

### GPIO\_FUNCn\_OUT\_SEL\_CFG\_REG

**C Struct:** `GPIO.func_out_sel_cfg[m]`

```
#include <soc/gpio_struct.h>
```

`m` is 0 to 39.

Field	Bits	Struct field
<code>GPIO_FUNCn_OEN_INV_SEL</code>	[11]	<code>GPIO.func_out_sel_cfg[n].oen_inv_sel</code>
<code>GPIO_FUNCn_OEN_SEL</code>	[10]	<code>GPIO.func_out_sel_cfg[n].oen_sel</code>
<code>GPIO_FUNCn_OUT_INV_SEL</code>	[9]	<code>GPIO.func_out_sel_cfg[n].inv_sel</code>
<code>GPIO_FUNCn_OUT_SEL</code>	[8:0]	<code>GPIO.func_out_sel_cfg[n].func_sel</code>

If `GPIO_FUNCn_OEN_INV_SEL` is set to 1, then the output enable signal is inverted.

The `GPIO_FUNCn_OUT_SEL` defines the output selection for the GPIO.

See also:

- GPIOs

## IO\_MUX\_x\_REG

Field	Bits	Struct field
<code>IO_x_MCU_SEL</code>	[14:12]	
<code>IO_x_FUNC_DRV</code>	[11:10]	
<code>IO_x_FUNC_IE</code>	[9]	
<code>IO_x_FUNC_WPU</code>	[8]	
<code>IO_x_FUNC_WPD</code>	[7]	
<code>IO_x_MCU_DRV</code>	[6:5]	
<code>IO_x_MCU_IE</code>	[4]	
<code>IO_x_MCU_WPU</code>	[3]	
<code>IO_x_MCU_WPD</code>	[2]	
<code>IO_x_SLP_SEL</code>	[1]	
<code>IO_x_MCU_OE</code>	[0]	

`IO_x_MCU_SEL` is function select ... functions are 1 - 6

See also:

- `soc/io_mux_reg.h`

## Strapping pins

When an ESP32 is powered on, we may wish to control/configure how it boots. To achieve this, a set of pins are defined that are read for the very short time that is considered the bootstrap time. For the sake of discussion, we should image this as the instantaneous time at which the device is powered up.

The values of these pins are "remembered" and available in the ESP32 register called `GPIO_STRAPPING`. The boot-loader will examine these values and act accordingly. We can also read this register later to see what values were in effect at boot time.

The pins have prescribed meanings in the ESP32 architecture:

## Boot mode source

We can boot from flash memory for normal operation or we can boot to read a new program into flash memory for loading an application.

- `GPIO0 = 1` – Boot from flash.
- `GPIO0 = 0` – Boot for loading a new program.

The floating state is 1 and hence will boot from flash.

## Debugging on U0TX0 at boot

When the ESP32 boot, it can write debugging information out through UART0 and its TX pin. This is useful during development but if we want to use this UART in our solutions, this diagnostic information will be treated as data over the UART and may interfere or confuse any devices attached. We can disable diagnostics from the UART by setting a strapping pin value:

- `MTDO = 1` – Use UART0 for debugging (default).
- `MTDO = 0` – Do not use UART0 for debugging.

The floating state is 1 and hence will use UART0 for debugging.

## Timing of SDIO slave

A couple of pins are used to configure the SDIO slave interfacing.

## Bootloader

When a device is powered up, control is given in a raw state to an area of code called the "bootloader". The responsibility of a bootloader is to bring the system up to a usable state and then load and give control to a user written application. The bootloader for ESP32 is supplied as the bootloader component within the ESP-IDF environment. Studying the bootloader provides us great insight into how the ESP32 operates.

Control starts at `call_start_cpu0`

```
call_start_cpu0 {
    reset CPU caches;
    call bootloader_main()
}
```

The `bootloader_main()` is responsible for much of the work:

```
bootloader_main() {
    // Load the bootloader header data from SPI address 0x1000
```

```

    call esp_image_load_header();

    // Load the partition table.
    call load_partition_table();
}

```

The booting mechanism of the ESP32 examines the settings of the "strapping" pins and based on their configuration we got into SPI boot mode or UART download mode or some other mode that isn't specified. In normal boot mode we examine address `0x1000` for the image of a software boot-loader. The standard software boot-loader reads the partition table to find the "app" image to give control to.

If we look at an example run of the `esptool.py` tool, we find that it loads the following:

```

bootloader.bin 0x1000
app.bin        0x10000
partitions.bin 0x4000

```

The in-built ROM in the ESP32 looks in flash address space at `0x1000` and expects to find a mapping table. This table lists a set of "segments". Each segment consists of:

- Offset from start of flash area (`0x1000`) of where the segment starts.
- Length in bytes of the segment.
- Location in ESP32 processor address space where the segment should be copied.

For example, if we run `esptool.py --chip image_info bootloader.bin` we will find:

```

esptool.py v2.0-dev
Image version: 1
Entry point: 40098200
4 segments

Segment 1: len 0x00000 load 0x3ffc0000 file_offs 0x00000018
Segment 2: len 0x00a08 load 0x3ffc0000 file_offs 0x00000020
Segment 3: len 0x01068 load 0x40078000 file_offs 0x00000a30
Segment 4: len 0x00378 load 0x40098000 file_offs 0x00001aa0
Checksum: 92 (valid)

```

We can also run `xtensa-esp32-elf-objdump -h bootloader.elf`:

Idx	Name	Size	VMA	LMA	File off	Algn
0	.iram1.text	00000378	40098000	40098000	00001b24	2**2
1	.dram0.bss	00000000	3ffc0000	3ffc0000	00000abc	2**0
2	.dram0.data	00000000	3ffc0000	3ffc0000	000000b4	2**0

```

3 .dram0.rodatta      00000a08  3ffc0000  3ffc0000  000000b4  2**2
4 .iram_pool_1.text  00001065  40078000  40078000  00000abc  2**2
5 .debug_frame       00000230  00000000  00000000  00001e9c  2**2
6 .debug_info        00002a37  00000000  00000000  000020cc  2**0
7 .debug_abbrev      000008fc  00000000  00000000  00004b03  2**0
8 .debug_loc         00000cac  00000000  00000000  000053ff  2**0
9 .debug_aranges     00000118  00000000  00000000  000060ab  2**0
10 .debug_ranges      00000110  00000000  00000000  000061c3  2**0
11 .debug_line        000016a7  00000000  00000000  000062d3  2**0
12 .debug_str         00000d36  00000000  00000000  0000797a  2**0
13 .comment           00000022  00000000  00000000  000086b0  2**0
14 .xtensa.info       00000038  00000000  00000000  000086d2  2**0

```

As a further example, here is an `image_info` listing of an application

```

esptool.py v2.0-dev
Image version: 1
Entry point: 40080868
8 segments

```

```

Segment 1: len 0x0ffe8 load 0x00000000 file_offs 0x00000018
Segment 2: len 0x049b0 load 0x3f400010 file_offs 0x00010008 → .flash.rodatta
Segment 3: len 0x01aa8 load 0x3ffbf2c0 file_offs 0x000149c0 → .dram0.datta
Segment 4: len 0x00400 load 0x40080000 file_offs 0x00016470 → .iram0.vectors
Segment 5: len 0x163b0 load 0x40080400 file_offs 0x00016878 → .iram0.text
Segment 6: len 0x00000 load 0x400c0000 file_offs 0x0002cc30 → .rtc.test
Segment 7: len 0x033d0 load 0x00000000 file_offs 0x0002cc38
Segment 8: len 0x2965c load 0x400d0018 file_offs 0x00030010 → .flash.text
Checksum: c5 (valid)

```

and an edited version of the objdump:

```

Idx Name          Size      VMA      LMA      File off  Algn
 0 .iram0.vectors  00000400  40080000  40080000  00006538  2**2
 1 .iram0.text     000163ae  40080400  40080400  00006938  2**2
 2 .dram0.bss     0000f2c0  3ffb0000  3ffb0000  00004a90  2**3
 3 .dram0.datta   00001aa8  3ffbf2c0  3ffbf2c0  00004a90  2**4
 4 .flash.rodatta 000049b0  3f400010  3f400010  000000e0  2**4
 5 .flash.text    00029659  400d0018  400d0018  0001cce8  2**2
 6 .rtc.test      00000000  400c0000  400c0000  00046341  2**0
 7 .debug_frame   00005590  00000000  00000000  00046344  2**2
 8 .debug_info    00070fbb  00000000  00000000  0004b8d4  2**0
 9 .debug_abbrev  000101a2  00000000  00000000  000bc88f  2**0
10 .debug_loc     000231ce  00000000  00000000  000cca31  2**0
11 .debug_aranges 000024c0  00000000  00000000  000efc00  2**3
12 .debug_ranges  00002a20  00000000  00000000  000f20c0  2**3
13 .debug_line    0002d918  00000000  00000000  000f4ae0  2**0
14 .debug_str     00012101  00000000  00000000  001223f8  2**0
15 .comment       00000062  00000000  00000000  001344f9  2**0
16 .xtensa.info   00000038  00000000  00000000  0013455b  2**0

```



See also:

- [The Bootloader](#)

## Power modes

The ESP32 can operate in different power modes. The distinguishing feature is how much current is consumed. Ideally we want the ESP32 to consume as little power as possible and the trade off on this is the amount of function that can be performed against current consumption. The items that affect current consumption includes

- Radio on or off
- CPUs on or off
- RAM being maintained

The distinct modes of operation have names associated with them:

- Active mode – This is the normal operational mode. The radio is on and it can both transmit and receive.
- Modem-sleep mode – In this mode the radio is powered off but other functions remain enabled. Radio is the biggest consumer of power.
- Light-sleep mode – The CPUs are paused however the RTC and ULP-co-processor remain operational. A variety of events can wake up the processor including timers or external interrupts.
- Deep-sleep mode – Only the RTC has power.
- Hibernation mode – Only one timer or an external RTC interrupt can wake us up.

## Peripherals

### Remote Control Peripheral - RMT

The primary purpose of this component of the ESP32 is to generate pulses sent via an infrared LED. When you point your TV remote control at your TV and press a button, an infrared LED at the front sends a sequence of pulses that are received by the TV and decoded. Since an infrared LED can be either "on" or "off" at any given time, the signal is encoded in the duration that the LED is either on or off. Whether the LED is on or off and for how long we call a data item. To use the RMT component, we build an array of data items and pass those to the RMT with the intent that it will then own the generation of the correct signals.

A data item is composed of a 16 bit value.

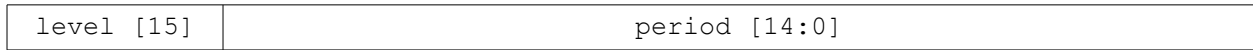

The level bit is either 1 or 0 describing the output signal while the period (15 bits in length) is the duration in clock ticks. 15 bits give us a range from 1-32767. A value of 0 for the period is used as an end marker. The normal maximum number of data item records is 128.

The RMT has 8 distinct channels with each channel having 128 16 bit records. Should we wish to send more than 128 records, we can extend a channel to use the channel data of subsequent adjacent channels. For example, if we are using only channel 0 then the data available for it can be that of channel 0, channel 1 up to channel 7 giving us a total of 1024 value records (1024 data items or 2048 bytes). The number of channels of data used by a specific channel is set in the register `RMT_MEM_OWNER_CHn`.

There is also an interesting mechanism that involves the buffer for a channel wrapping around. Imagine that we have a default buffer size of 128 \* 16bit records. If we need to send more than 128 records, we can pre-load a buffer with our first 128 values and set the RMT transmitting. When it has transmitted the first 128 values, it will generate an interrupt that can be used to re-fill the buffer with the new values and progress will continue.

The RAM for these blocks starts at RMT base address + 0x800.

Assuming each channel uses just its own block, the channels start at:

Channel	Address
0	RMT base address + 0x800
1	RMT base address + 0x800 + 0x100
2	RMT base address + 0x800 + 0x200
3	RMT base address + 0x800 + 0x300
4	RMT base address + 0x800 + 0x400
5	RMT base address + 0x800 + 0x500
6	RMT base address + 0x800 + 0x600
7	RMT base address + 0x800 + 0x700

Each channel has two control registers associated with it called `RMT_CHnCONF0_REG` and `RMT_CHnCONF1_REG`.

Register – `RMT_CHnCONF0_REG`

Name	Bits	Field	Description
reserved	[31]	clk_en	Reserved. Set to 0.
RMT_MEM_PD	[30]	mem_pd	Power down memory. <ul style="list-style-type: none"> <li>• 0 – memory is powered up</li> <li>• 1 – memory is powered down</li> </ul>
RMT_CARRIER_OUT_LV_CHn	[29]	carrier_out_lv	Carrier present on: <ul style="list-style-type: none"> <li>• 0 – transmit on high</li> <li>• 1 – transmit on low</li> </ul>
RMT_CARRIER_EN_CHn	[28]	carrier_en	Is carrier signal enabled? <ul style="list-style-type: none"> <li>• 0 – disabled</li> <li>• 1 – enabled</li> </ul>
RMT_MEM_SIZE_CHn	[27:24]	mem_size	Memory blocks allocated to channel. 4bits. <b>(0x01)</b>
RMT_IDLE_THRESH_CHn	[23:8]	idle_thres	Clock cycles of no change indicates an end of reception in receive mode. <b>(0x1000)</b>
RMT_DIV_CNT_CHn	[7:0]	div_cnt	Divider for channel clock. <b>(0x02)</b>

## Register – RMT\_CHnCONF1\_REG

Name	Bits	Field	Description
reserved	[31:20]	reserved20	Reserved. Set to 0.
RMT_IDLE_OUT_EN_CHn	[19]	idle_out_en	Output enable. <b>(0)</b>
RMT_IDLE_OUT_LV_CHn	[18]	idle_out_lv	Output signal in idle state. <b>(0)</b>
RMT_REF_ALWAYS_ON_CHn	[17]	ref_always_on	Selection of channel base clock: <ul style="list-style-type: none"> <li>• 0 – clk_ref.</li> <li>• 1 – clk_apb.</li> </ul>
RMT_REF_CNF_RST_CHn	[16]	ref_cnf_rst	Reset the clock divider. <b>(0)</b>
RMT_RX_FILTER_THRES_CHn	[15:8]	rx_filter_thres	Threshold for of pulse width in receive mode. <b>(0x0f)</b>
RMT_RX_FILTER_EN_CHn	[7]	rx_filter_en	Enable receive filter. <b>(0)</b>
RMT_TX_CONTI_MODE_CHn	[6]	tx_conti_mode	Enable repeating transmission. <ul style="list-style-type: none"> <li>• 0 – Go idle at end of transmission.</li> <li>• 1 – Repeat at end of transmission.</li> </ul>
RMT_MEM_OWNER_CHn	[5]	mem_owner	Block used for receive or transmit? <ul style="list-style-type: none"> <li>• 0 – RAM used for transmission.</li> <li>• 1 – RAM used for reception.</li> </ul>
reserved	[4]	apb_mem_rst	Reserved. Set to 0.
RMT_MEM_RD_RST_CHn	[3]	mem_rd_rst	Reset read ram for transmitter access. <b>(0)</b>
RMT_MEM_WR_RST_CHn	[2]	mem_wr_rst	Reset write ram for receiver access. <b>(0)</b>
RMT_RX_EN_CHn	[1]	rx_en	Enable receiving on channel. 1 – Start receiving. <b>(0)</b>
RMT_TX_START_CHn	[0]	tx_start	Start sending on channel. 1 – Start transmitting. <b>(0)</b>

Let us imagine we want to send 8 bits of square wave through channel 0. This means we will want 17 records (one for each value transition and a terminator). We will then want to set RMT\_CH0CONF0\_REG to

- RMT\_MEM\_PD = 0 (Power up memory)
- RMT\_CARRIER\_EN\_CH0 = 0 (carrier disabled)
- RMT\_MEM\_SIZE\_CH0 = 1 (1 memory block)
- RMT\_DIV\_CNT\_CH0 = 1 (divider for clock)

We will also want to set RMT\_CH0CONF1\_REG to:

- RMT\_IDLE\_OUT\_EN\_CH0 = 1 (Output enable)
- RMT\_IDLE\_OUT\_LV\_CH0 = 0 (0 in idle state)
- RMT\_REF\_ALWAYS\_ON\_CH0 = 0 (channel base clock)
- RMT\_MEM\_OWNER\_CH0 = 0 (used for transmission)
- RMT\_MEM\_RD\_RST\_CH0 = 1 (Reset read ram)
- RMT\_RX\_EN\_CH0 = 0 (Enable transmit on channel)
- RMT\_TX\_START\_CH0 = 1 (Start transmitting)

Within the header file called "soc/rmt\_struct.h" we have a global variable defined called RMTMEM that contains definitions of the data buffers.

There is also a variable called RMT that contains the

The signal mapping for GPIOs is:

Function	Signal	Constant
rmt_sig_out0	87	RMT_SIG_OUT0_IDX
rmt_sig_out1	88	RMT_SIG_OUT1_IDX
rmt_sig_out2	89	RMT_SIG_OUT2_IDX
rmt_sig_out3	90	RMT_SIG_OUT3_IDX
rmt_sig_out4	91	RMT_SIG_OUT4_IDX
rmt_sig_out5	92	RMT_SIG_OUT5_IDX
rmt_sig_out6	93	RMT_SIG_OUT6_IDX
rmt_sig_out7	94	RMT_SIG_OUT7_IDX

To say that a signal will appear on a particular GPIO, we execute the following logic:

```
include "soc/gpio_sig_map.h"

int gpioNum = 17;
PIN_FUNC_SELECT(GPIO_PIN_MUX_REG[gpioNum], PIN_FUNC_GPIO);
gpio_set_direction(gpioNum, GPIO_MODE_OUTPUT);
gpio_matrix_out(gpioNum, RMT_SIG_OUT0_IDX, 0, 0);
```

## SPI

The header file called "soc/spi\_struct.h" provides a data type called "spi\_dev\_t" that is a memory map into the registers that control SPI. There are four instances of this structure, one for each of the hardware SPIs available on an ESP32. These are called SPI0, SPI1, SPI2 and SPI3. SPI0 is reserved for internal use and should be ignored.

If one looks there, you will find a bewilderingly large number of settings. Poking those values correctly to achieve SPI is not a trivial matter and documentation on those features is still a while away.

See also:

- The Arduino Hardware Abstraction Layer SPI

## PID Controller

I have no idea what this is.

## UART

Read the UART status register?

```
READ_PERI_REG(UART_INT_ST_REG(??))
```

UART\_FRM\_ERR\_INT\_ENA ---?

UART\_RXFIFO\_TOUT\_INT\_ENA – Timeout interrupt enable

UART\_RXFIFO\_FULL\_INT\_ENA – RX FIFO length is > than threshold

UART\_GET\_RXFIFO\_CNT → #define to

```
#define UART_GET_RXFIFO_CNT(i)
```

```
GET_PERI_REG_BITS2(UART_STATUS_REG(i), UART_RXFIFO_CNT_V,  
UART_RXFIFO_CNT_S)
```

Number of bytes in RX queue

UART\_GET\_RXFIFO\_RD\_BYTE → #define to

```
#define UART_GET_RXFIFO_RD_BYTE(i)
```

```
GET_PERI_REG_BITS2(UART_FIFO_REG(i), UART_RXFIFO_RD_BYTE_V,  
UART_RXFIFO_RD_BYTE_S)
```

Read a byte from the RX queue

## I2S Peripheral

The I2S peripheral is more than just working with the I2S protocol. It is also a powerful data mover of parallel data into and out of RAM without application involvement.

First, let us realize that there are **two** I2S buses called I2S0 and I2S1.

The I2S bus can output a high precision clock.

A very special *mode* of the I2S bus is called the "LCD mode". This deviates dramatically from any I2S audio protocols but gives us access to driving an external parallel display (LCD) or receiving parallel data from a camera.

See also:

- I2S Bus
- [AMBA 3 AHB-Lite Protocol](#)

## I2S Input Data

For DMA input, we need to specify which pins are to be used for input. One way to do this is to which pins are to be enabled using:

```
SET_PERI_REG_MASK(GPIO_ENABLE_W1TS_REG, <mask>);
```

We can set the linked list descriptor in the I2S\_IN\_LINK\_REG.

## I2S Clock

The I2S\_CLK signal is an output signal used to communicate with the partner. The clock is derived from either the PLL\_D2\_CLK or the APLL\_CLK as defined by the I2S\_CLKA\_ENA bit of I2S\_CLCKM\_CONFIG\_REG. The default is PLL\_D2\_CLK.

The frequency of the clock is given by the following formula:

$$F_{i2s} = \frac{F_{pll}}{N + \frac{b}{a}}$$

For the PLL\_D2\_CLK, F<sub>pll</sub> will be 160MHz.

- N is the value REG\_CLKM\_DIV\_NUM of I2S\_CLKM\_CONF\_REG
- b is I2S\_CLKM\_DIV\_A of I2S\_CLCKM\_CONF\_REG
- a is I2S\_CLKM\_DIV\_B of I2S\_CLCKM\_CONF\_REG

### Camera mode

The I2S peripheral has a mode called "camera" mode. In that mode, it is able to retrieve data from a camera. To do this, we need some logical pins:

Logical Name	ESP32 Identity	WROOM Dev Kit
Data 0	I2S0I_DATA_IN0_IDX	GPIO4
Data 1	I2S0I_DATA_IN1_IDX	GPIO5
Data 2	I2S0I_DATA_IN2_IDX	GPIO18
Data 3	I2S0I_DATA_IN3_IDX	GPIO19
Data 4	I2S0I_DATA_IN4_IDX	GPIO36
Data 5	I2S0I_DATA_IN5_IDX	GPIO39
Data 6	I2S0I_DATA_IN6_IDX	GPIO34
Data 7	I2S0I_DATA_IN7_IDX	GPIO35
VSYNC	I2S0I_V_SYNC_IDX	GPIO25
HREF	I2S0_H_ENABLE_IDX	GPIO23
PCLK	I2S0_WS_IN_IDX	GPIO22

Consider a logical camera input. It would consist of:

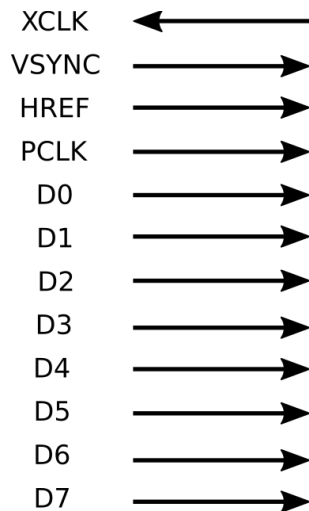

The way to read this is that the camera has input from an external clock ( $X_{CLK}$ ) and generates 8 parallel lines of data output (the camera data bus) plus three additional interrupt signals for vertical sync, horizontal sync and pixel clock.

So far, so good. Now let us consider the ESP32 I2S peripheral as consuming this data ... and it is here that things get interesting. While one might imagine that the I2S peripheral should behave as a master (providing the clock) that isn't how it is designed

to be used. Instead the I2S peripheral should be placed into slave mode which means that it is the consumer of a clock signal. That seems OK as we have a `PCLK` signal to use. However, that's not how the story works. The ESP32 (acting as a slave) does **not** synchronize clocks with the master (the camera). Instead, the ESP32 runs its own internal clock which must be at least twice as fast as the master (camera) clock. (Is this true?) For technical reasons the ESP32 I2S peripheral has a maximum value of 40MHz which means that the master (camera) clock can never be greater than 20MHz. With this in mind, we now learn that the ESP32 isn't actually "interrupted" by the master (camera's) clock, instead the ESP32 is sampling the incoming clock signal. As long as the sampling is fast enough, the ESP32 can detect a clock transition by seeing that the signal has gone from a previous high to a current reading of low or a previous low to a current reading of high.

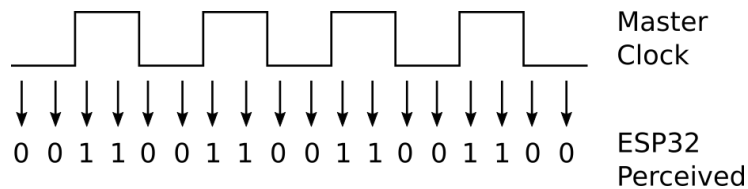

This design is known in digital electronics as a "synchronizer stage". Thankfully, we do not need to understand all the mechanical details but what we **do** have to get right is the setting of the ESP32 I2S clock. The I2S clock is known as the `I2S_CLK` signal. We do **not** need to expose this on an IO pin since it need not be connected to anything. However, we **do** need to set its speed. We do this through three settings in the `I2S_CLKM_CONF_REG` as follows:

Set `REG_CLKM_DIV_NUM` to be 2

Set `REG_CLKM_DIV_A` to 1

Set `REG_CLKM_DIV_B` to 0

From the clock speed calculation formula for I2S which is:

$$F_{i2s} = \frac{F_{pll}}{N + \frac{b}{a}}$$

This gives us a clock speed value of:

$$F_{i2s} = \frac{F_{pll}}{2 + \frac{0}{1}}$$

which is:

$$F_{i2s} = \frac{F_{pll}}{2}$$



Since Fpll is the PLL\_D2\_CLK which runs at 160MHz, this then gives us the final result of 80MHz as the sampling rate of the external clock.

In actual code, we would write:

```
// Configure clock divider
I2S0.clkm_conf.clkm_div_a = 1;
I2S0.clkm_conf.clkm_div_b = 0;
I2S0.clkm_conf.clkm_div_num = 2;
```

### WAIT ... SOMETHING IS NOW WRONG WITH THE STORY

Reading the Tech Ref, there are some "rules" to put the I2S into camera mode. Specifically:

Field	Register	Value
I2S_CAMERA_EN	I2SCONF2_REG	1
I2S_LCD_EN	I2SCONF2_REG	1
I2S_RX_SLAVE_MOD	I2SCONF_REG	1
I2S_RX_MSB_RIGHT	IS2CONF_REG	0
I2S_RX_RIGHT_FIRST	IS2CONF_REG	0
I2S_RX_CHAN_MOD	I2SCONF_CHAN_REG	1
I2S_RX_FIFO_MOD	I2S_FIFO_CONF_REG	1

Studying the sample made available from Ivan at Espressif, we find that it performs the following logical functions:

Toggles the reset flags in I2S\_LC\_CONF\_REG register:

I2S\_IN\_RST – Reset the RX DMA finite state machine.

I2S\_AHBM\_RST – Reset the AHB interface of DMA.

I2S\_AHBM\_FIFO\_RST – Reset the AHB interface cmdFIFO of DMA.

Next it toggles further reset flags:

I2S\_RX\_RESET

I2S\_RX\_FIFO\_RESET

I2S\_TX\_RESET

I2S\_TX\_FIFO\_RESET

We then block until some state changes.

Next set:

I2S\_RX\_SLAVE\_MOD=1 rx\_slave\_mode = 1

I2S\_LCD\_EN = 1

I2S\_CAMERA\_EN = 1

The Clock

I2S\_DSCR\_EN = 1 (Enable I2S DMA mode)

I2S\_RX\_FIFO\_MOD\_FORCE\_EN = 1

I2S\_RX\_CHAN\_MOD = 1

I2S\_RX\_BITS\_MOD = 16

### Registers

The registers are:

Name	Description	Access
I2S_CONF_REG	Configuration and start/stop bits	R/W
I2S_CONF1_REG	PCM configuration	R/W
I2S_CONF2_REG	ADC/LCD/Camera configuration	R/W
I2S_TIMING_REG	Signal delay and timing	R/W
I2S_FIFO_CONF_REG	FIFO configuration	R/W
I2S_CONF_SINGLE_DATA_REG	Static channel output value	R/W
I2S_CONF_CHAN_REG	Channel configuration	R/W
I2S_LC_HUNG_CONF_REG	Timeout detection configuration	R/W
I2S_CLKM_CONF_REG	Bitclock configuration	R/W
I2S_SAMPLE_RATE_CONF_REG	Sample rate configuration	R/W
I2S_PD_CONF_REG	Power down register	R/W
I2S_LC_CONF_REG	DMA configuration	R/W
I2S_RXEOF_NUM_REG	Receive data count	R/W
I2S_OUT_LINK_REG	DMA transmit linked list configuration address	R/W
I2S_IN_LINK_REG	DMA receive linked list configuration and address	R/W
I2S_OUT_EOF_DES_ADDR_REG	Address of transmit link descriptor producing EOF	RO
I2S_IN_EOF_DES_ADDR_REG	Address of receive link descriptor producing EOF	RO
I2S_OUT_EOF_BFR_DES_ADDR_REG	Address of transmit buffer producing EOF	RO
I2S_INLINK_DSCR_REG	Address of current inlink descriptor	RO
I2S_INLINK_DSCR_BF0_REG	Address of next inlink descriptor	RO
I2S_INLINK_DSCR_BF1_REG	Address of next inlink data buffer	RO
I2S_OUTLINK_DSCR_REG	Address of current outlink descriptor	RO
I2S_OUTLINK_DSCR_BF0_REG	Address of next outlink descriptor	RO
I2S_OUTLINK_DSCR_BF1_REG	Address of next outlink data buffer	RO
I2S_LC_STATE0_REG	DMA receive status	RO
I2S_LC_STATE1_REG	DMA transmit status	RO
I2S_PDM_CONF_REG	PDM configuration	R/W
I2S_PDM_FREQ_CONF_REG	PDM frequencies	R/W
I2S_INT_RAW_REG	Raw interrupt status	RO
I2S_INT_ST_REG	Masked interrupt status	RO
I2S_INT_ENA_REG	Interrupt enable bits	R/W
I2S_INT_CLR_REG	Interrupt clear bits	RO

See also:

- [soc/esp32/include/soc/i2s\\_reg.h](#)

- [soc/esp32/include/soc/i2s\\_struct.h](#)

### I2S\_CONF\_REG

This field is `conf` in the struct.

I2S_SIG_LOOPBACK	
I2S_RX_MSB_RIGHT	
I2S_TX_MSB_RIGHT	
I2S_RX_MONO	
I2S_TX_MONO	
I2S_RX_SHORT_SYNC	
I2S_TX_SHORT_SYNC	
I2S_RX_MSB_SHIFT	
I2S_TX_MSB_SHIFT	
I2S_RX_RIGHT_FIRST	Set this bit receiver right channel data first.
I2S_TX_RIGHT_FIRST	Set this bit to transmit right channel data first.
I2S_RX_SLAVE_MOD	Set this bit to enable slave receiver mode.
I2S_TX_SLAVE_MOD	Set this bit to enable slave transmitter mode.
I2S_RX_START	Set this bit to start receiving.
I2S_TX_START	Set this bit to start transmitting.
I2S_RX_FIFO_RESET	Set this bit to reset the receive FIFO.
I2S_TX_FIFO_RESET	Set this bit to reset the transmit FIFO/
I2S_RX_RESET	Set this bit to reset the receiver.
I2S_TX_RESET	Set this bit to reset the transmitter.

### I2S\_CONF2\_REG

This field is `conf2` in the struct.

I2S_INTER_VALID_EN	Enable internal validation.
I2S_EXT_ADC_START_EN	Enable external ADC.
I2S_LCD_EN	Enable LCD mode.
I2S_LCD_TX_SDX2_EN	Duplicate data pairs.
I2S_LCD_TX_WRX2_EN	Write data in duplicate in LCD mode.
I2S_CAMERA_EN	Enable camera mode.

Looking at the struct there also appears to be "data\_enable" and "data\_enable\_test\_en".

### I2S\_CLKM\_CONF\_REG

This is field `clkm_conf`.

The high level function which sets these values is `i2s_set_clk()`.

I2S_CLKA_ENA [21]	<ul style="list-style-type: none"><li>• 0 – Use PLL D2</li><li>• 1 – Use <code>clk_apll</code></li></ul>
I2S_CLKM_DIV_A [19:14]	Divider denominator
I2S_CLKM_DIV_B [13:8]	Divider numerator
I2S_CLKM_DIV_NUM[ 7:0]	Divider integral value

### I2S\_CONF\_CHAN\_REG

This field is `conf_chan` in the struct.

I2S_RX_CHAN_MOD [4:3]	
I2S_TX_CHAN_MOD [2:0]	

### I2S\_LC\_CONF\_REG

This field is `lc_conf` in the struct.

I2S_MEM_TX_EN	
I2S_CHECK_OWNER	
I2S_OUT_DATA_BURST_EN	
I2S_INDSCR_BURST_EN	
I2S_OUTDSCR_BURST_EN	DMA outlink descriptor transfer mode configuration.
I2S_OUT_EOF_MODE	Interrupt config.
I2S_OUT_AUTO_WRBACK	Set to 1 to enable automatic outlink-writeback when all the data in tx buffer has been transmitted.
I2S_OUT_LOOP_TEST	Set to loop test outlink.
I2S_IN_LOOP_TEST	Set to loop test inlink.
I2S_AHBM_RST	Toggle to 1 to reset the AHB interface of DMA.
I2S_AHBM_FIFO_RST	Toggle to 1 to reset the AHB interface cmdFIFO of DMA.
I2S_OUT_RST	Toggle to 1 to reset the outgoing DMA state machine.
I2S_IN_RST	Toggle to 1 to reset the incoming DMA state machine.

### I2S\_FIFO\_CONF\_REG

This field is `fifo_conf` in the struct.

I2S_RX_FIFO_MOD_FORCE_EN	Should always be 1.
I2S_TX_FIFO_MOD_FORCE_EN	Should always be 1.
I2S_RX_FIFO_MOD [19:16]	Receive FIFO mode config. <ul style="list-style-type: none"><li>• 0 – 16 bit dual channel data</li><li>• 1 – 16 bit single channel data</li><li>• 2 – 32 bit dual channel data</li><li>• 3 – 32 bit single channel data</li></ul>
I2S_TX_FIFO_MOD [15:13]	Transmit FIFO mode config. <ul style="list-style-type: none"><li>• 0 – 16 bit dual channel data</li><li>• 1 – 16 bit single channel data</li><li>• 2 – 32 bit dual channel data</li><li>• 3 – 32 bit single channel data</li></ul>
I2S_DSCR_EN	Set this to enable I2S DMA mode.
I2S_TX_DATA_NUM [11:6]	Threshold of data length in the transmit FIFO.
I2S_RX_DATA_NUM [5:0]	Threshold of data length in the receive FIFO.

### I2S\_IN\_LINK\_REG

This field is `in_link` in the struct.

I2S_INLINK_RESTART	
I2S_INLINK_START	
I2S_INLINK_STOP	
I2S_INLINK_ADDR	

### I2S\_RXEOF\_NUM\_REG

This field is `rx_eof_num` in the struct.

This defined the length of the data to be received. After receiving this data, an `I2S_IN_SUC_EOF_INT` interrupt will be triggered. This will indicate that all the data expected to have been received has been received.

### I2S\_CONF\_CHAN\_REG

This field is `conf_chan` in the struct.

I2S_RX_CHAN_MOD [4:3]	I2S receiver channel mode.
I2S_TX_CHAN_MOD [2:0]	I2S transmitter channel mode.

### I2S\_SAMPLE\_RATE\_CONF\_REG

This field is `sample_rate_conf` in the struct.

I2S_RX_BITS_MOD [23:18]	Bit length of I2S receiver channel.
I2S_TX_BITS_MOD [17:12]	Bit length of I2S transmitter channel.
I2S_RX_BCK_DIV_NUM [11:6]	Bit clock configuration in receiver.
I2S_TX_BCK_DIV_NUM [5:0]	Bit clock configuration in transmitter.

### I2S\_INT\_RAW\_REG

This field is `int_raw` in the struct.

I2S_OUT_TOTAL_EOF_INT_RAW	
I2S_IN_DSCR_EMPTY_INT_RAW	
I2S_OUT_DSCR_ERR_INT_RAW	
I2S_IN_DSCR_ERR_INT_RAW	
I2S_OUT_EOF_INT_RAW	
I2S_OUT_DONE_INT_RAW	
I2S_IN_SUC_EOF_INT_RAW	
I2S_IN_DONE_INT_RAW	
I2S_TX_HUNG_INT_RAW	
I2S_RX_HUNG_INT_RAW	
I2S_TX_EMPTY_INT_RAW	
I2S_TX_WFULL_INT_RAW	
I2S_RX_EMPTY_INT_RAW	
I2S_RX_WFULL_INT_RAW	
I2S_TX_PUT_DATA_INT_RAW	
I2S_RX_TAKE_DATA_INT_RAW	

### I2S\_INT\_ENA\_REG

This field is `int_ena` in the struct.

I2S_OUT_TOTAL_EOF_INT_RAW	
I2S_IN_DSCR_EMPTY_INT_RAW	
I2S_OUT_DSCR_ERR_INT_RAW	
I2S_IN_DSCR_ERR_INT_RAW	
I2S_OUT_EOF_INT_RAW	
I2S_OUT_DONE_INT_RAW	
I2S_IN_SUC_EOF_INT_RAW	
I2S_IN_DONE_INT_RAW	
I2S_TX_HUNG_INT_RAW	
I2S_RX_HUNG_INT_RAW	
I2S_TX_EMPTY_INT_RAW	
I2S_TX_WFULL_INT_RAW	
I2S_RX_EMPTY_INT_RAW	
I2S_RX_WFULL_INT_RAW	
I2S_TX_PUT_DATA_INT_RAW	
I2S_RX_TAKE_DATA_INT_RAW	

I2S\_INT\_CLR\_REG

This field is `int_clr` in the struct.

I2S_OUT_TOTAL_EOF_INT_ENA	
I2S_IN_DSCR_EMPTY_INT_ENA	
I2S_OUT_DSCR_ERR_INT_ENA	
I2S_IN_DSCR_ERR_INT_ENA	
I2S_OUT_EOF_INT_ENA	
I2S_OUT_DONE_INT_ENA	
I2S_IN_SUC_EOF_INT_ENA	
I2S_IN_DONE_INT_ENA	
I2S_TX_HUNG_INT_ENA	
I2S_RX_HUNG_INT_ENA	
I2S_TX_EMPTY_INT_ENA	
I2S_TX_WFULL_INT_ENA	
I2S_RX_EMPTY_INT_ENA	
I2S_RX_WFULL_INT_ENA	
I2S_TX_PUT_DATA_INT_ENA	
I2S_RX_TAKE_DATA_INT_ENA	



## RTC

### RTCIO\_RTC\_GPIO\_OUT\_DATA

Set the output values of RTC GPIO 0-17. Bit 14 is GPIO 0, bit 15 is GPIO 1 and so on.

### RTCIO\_RTC\_GPIO\_OUT\_DATA\_W1TS

Setting a 1 in the corresponding bit sets the corresponding output GPIO to 1. A 0 bit leaves the output GPIO unchanged.

### RTCIO\_RTC\_GPIO\_OUT\_DATA\_W1TC

Setting a 1 in the corresponding bit clears the corresponding output GPIO to 0. A 0 bit leaves the output GPIO unchanged.

### RTCIO\_RTC\_GPIO\_ENABLE

Specify which bits of GPIO are output.

### RTCIO\_RTC\_GPIO\_ENABLE\_W1TS

### RTCIO\_RTC\_GPIO\_ENABLE\_W1TC

### RTCIO\_RTC\_GPIO\_STATUS\_INT

Determine the status of the interrupt enablement flags.

### RTCIO\_RTC\_GPIO\_STATUS\_INT\_W1TS

### RTCIO\_RTC\_GPIO\_STATUS\_INT\_W1TC

### RTCIO\_RTC\_GPIO\_IN\_NEXT

The input values from the GPIOs associated with the RTC subsystem.

RTCIO\_RTC\_GPIO\_PINn\_WAKEUP\_ENABLE

RTCIO\_RTC\_GPIO\_PINn\_INT\_TYPE

RTCIO\_RTC\_GPIO\_PINn\_PAD\_DRIVER

RTCIO\_DIG\_PAD\_HOLD\_REG

RTCIO\_HALL\_XPD\_HALL

RTCIO\_HALL\_PHASE

RTCIO\_SENSOR\_SENSEn\_HOLD

RTCIO\_SENSOR\_SENSEn\_MUX\_SEL

RTCIO\_SENSOR\_SENSEn\_FUN\_SEL

RTCIO\_SENSOR\_SENSEn\_SLP\_SEL

RTCIO\_SENSOR\_SENSEn\_SLP\_IE

RTCIO\_SENSOR\_SENSEn\_FUN\_IE

RTCIO\_ADC\_ADCn\_HOLD

RTCIO\_ADC\_ADCn\_MUX\_SEL

RTCIO\_ADC\_ADCn\_FUN\_SEL

RTCIO\_ADC\_ADCn\_SLP\_SEL

RTCIO\_ADC\_ADCn\_SLP\_IE

RTCIO\_ADC\_ADCn\_FUN\_IE

RTCIO\_PAD\_PDAC1\_DRV

RTCIO\_PAD\_PDAC1\_HOLD

RTCIO\_PAD\_PDAC1\_RDE

RTCIO\_PAD\_PDAC1\_RUE

RTCIO\_PAD\_PDAC1\_DAC

RTCIO\_PAD\_PDAC1\_XPD\_DAC

RTCIO\_PAD\_PDAC1\_MUX\_SEL

RTCIO\_PAD\_PDAC1\_FUN\_SEL

RTCIO\_PAD\_PDAC1\_SLP\_SEL

RTCIO\_PAD\_PDAC1\_SLP\_IE

RTCIO\_PAD\_PDAC1\_SLP\_OE

RTCIO\_PAD\_PDAC1\_FUN\_IE

RTCIO\_PAD\_PDAC1\_DAC\_XPD\_FORCE

.... and more

## ULP Processor

The ULP is an ultra-low power consumption component in the ESP32 that can execute with extremely little power consumption. It has 4 registers, some simple arithmetic, memory access and branch instructions. The thinking behind it is that if we think about the ESP32 processor, it consumes power while operating which can drain a battery. What we might want to do is power-down the processor but leave "just enough" function ticking over to wake up the processor in the event that something "interesting" is detected. This becomes useful when the ESP32 is being used as a battery powered device.

When the ESP32 is in its deep-sleep mode, the main cores are powered down and consuming no resources. The ULP co-processor continues to function. The RAM available to it is the section known as RTC memory. It leverages the `RTC_FAST_CLK` clock which runs at 8MHz. It should also be noted that the ULP co-processor can also run just fine when the main processors are also executing.

The memory region that the ULP co-processor can access is the `RTC_SLOW_MEM` region as well as the registers in `RTC_CNTL`, `RTC_IO` and `SARADC` peripherals.

The ULP co-processor has four general purpose registers and one additional register used for loop counting. The four general purpose registers are called R0, R1, R2 and R3 with the loop counting register is called `stage_cnt`. Note that `stage_cnt` is an 8 bit register while R0-R3 are 16 bit registers.

Specs:

- Four general purpose registers each 16 bits in size

The ULP program is run by the main application which should call `ulp_load_binary()` to load the program into RTC memory and then call `ulp_run()` to start it.

See also:

- [ULP coprocessor programming](#)
- [Github: espressif/esp-idf – ULP Pulse Counting Example](#)
- [Github: krzchb/ulp-loop](#)
- [Github: ULP I2C demo application](#)

## Preparing a ULP co-processor environment

The ULP co-processor support is still quite new so instructions may change relatively quickly. As of just now (2017-11), this is the recipe.

1. Visit <https://github.com/espressif/binutils-esp32ulp/wiki#downloads> and download the tool chain for your platform.
2. Extract and ensure the resulting "bin" folder is in your execution path. In my environment, I installed at `/opt/ulp-elf-binutils` which meant that I added `/opt/ulp-elf-binutils/bin` to my path.

For any project that is going to include ULP co-processor support, we must enable it within "make menuconfig" under the Component Config > ESP32-Specific > Enable Ultra Low Power (ULP) Coprocessor

To augment a main project

1. Create a directory called ulp in the main directory.
2. Edit component.mk in the main directory and add:
3. <Editor content missing ... to be researched>

To create a component that includes ULP, we:

1. Create a component directory.
2. Create source files with ".S" extension and placed in a directory of their own within the component (eg the ./ulp directory).
3. Change the component makefile to:

```
ULP_APP_NAME ?= ulp_$(COMPONENT_NAME)
ULP_S_SOURCES = $(COMPONENT_PATH)/ulp/ulp_source_file.S
ULP_EXP_DEP_OBJECTS := main.o
include $(IDF_PATH)/components/ulp/component_ulp_common.mk
```

## ULP Instruction set

Each instruction in the ULP co-processor instruction set is composed of a 32 bit value.



The operation code (Op Code) are composed of the bits [31:28] meaning that there are potentially 16 distinct instructions with each instruction being able to be customized by its operands.

The instruction set of the ULP co-processor is made up of the following op-codes:

Op Code	Description
NOP	No operation
ADD	Add to a register *
SUB	Subtract from register *
AND	Logical AND of two operands *
OR	Logical OR of two operands *
LSH	Logical Shift Left *
RSH	Logical Shift Right *
MOVE	Move to register *
ST	Store data to memory
LD	Load data from memory
JUMP	Jump to an absolute address
JUMPR	Jump relative with condition
JUMPS	Jump relative based on stage count
STAGE_RST	Reset the stage count register *
STAGE_INC	Increment the stage count register *
STAGE_DEC	Decrement the stage count register *
HALT	End the program
WAKE	Wakeup the chip
SLEEP	Set the ULP wakeup timer period
WAIT	Wait some number of cycles
TSENS	Do measurement with the temperature sensor
ADC	Do measurement with ADC
REG_RD	Read from peripheral register
REG_WR	Write to peripheral register
I2C_RD	
I2C_WR	

Note: Instructions marked with a “\*” affect the ALU.

Each instruction is composed of 32bits with bits [28:31] representing the instruction and bits [0:27] encoding the operands. The program exists in an area of RAM called "Slow Memory" with the mnemonic `RTC_SLOW_MEM`. This memory is visible to the main CPUs in the address range `0x5000_0000` to `0x5000_1FFF` which is 8KBytes in size. As such, a ULP co-processor application can't be larger than this.

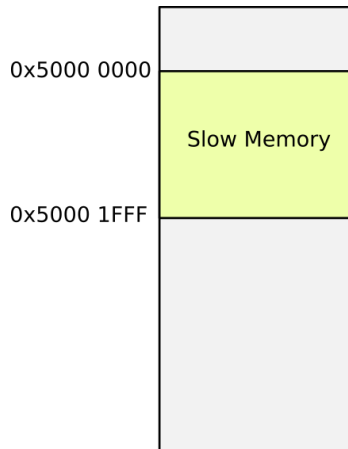

### NOP - No operation

This instruction changes no data nor changes any registers other than the program counter which is incremented to point to the next instruction. Historically, the NOP instruction was left in place in code as a holder for future instructions. These NOPs could then be “patched” with new instructions such as call-return handlers to newly injected subroutines. While in theory this is still applicable, it isn't likely to ever be used for that purpose in modern times.

### ADD - Add to a register

- `ADD Rdst, Rsrc1, Rsrc2` // `Rdst = Rsrc1 + Rsrc2`
- `ADD Rdst, Rsrc, Imm` // `Rdst = Rsrc + Imm`

Here we add either `Rsrc1` to `Rsrc2` and store the result in `Rdst` or we add an immediate value to `Rsrc` and store in `Rdst`.

### SUB - Subtract from register

- `SUB Rdst, Rsrc1, Rsrc2` // `Rdst = Rsrc1 - Rsrc2`
- `SUB Rdst, Rsrc, Imm` // `Rdst = Rsrc - Imm`

Subtract `Rsrc2` from `Rsrc1` and store in `Rdst` or subtract an immediate value from `Rsrc` and store in `Rdst`.

### AND - Logical AND of two operands

- `AND Rdst, Rsrc1, Rsrc2 // Rdst = Rsrc1 & Rsrc2`
- `AND Rdst, Rsrc, Imm // Rdst = Rsrc & Imm`

Perform a logical and of `Rsrc1` and `Rsrc2` and store the result in `Rdst` or perform a logical and of `Rsrc` and the immediate value and store in `Rdst`.

### OR - Logical OR of two operands

- `OR Rdst, Rsrc1, Rsrc2 // Rdst = Rsrc1 | Rsrc2`
- `OR Rdst, Rsrc, Imm // Rdst = Rsrc | Imm`

Perform a logical or of `Rsrc1` and `Rsrc2` and store the result in `Rdst` or perform a logical or of `Rsrc` and the immediate value and store in `Rdst`.

### LSH - Logical Shift Left

- `LSH Rdst, Rsrc1, Rsrc2 // Rdst = Rsrc1 << Rsrc2`
- `LSH Rdst, Rsrc, Imm // Rdst = Rsrc << Imm`

Perform a logical shift left of `Rsrc1` by `Rsrc2` bits and store in `Rdst` or Perform a logical shift left of `Rsrc` by the immediate value bits and store in `Rdst`.

### RSH - Logical Shift Right

- `RSH Rdst, Rsrc1, Rsrc2 // Rdst = Rsrc1 >> Rsrc1`
- `RSH Rdst, Rsrc1, Imm // Rdst = Rsrc >> Imm`

Perform a logical shift right of `Rsrc1` by `Rsrc2` bits and store in `Rdst` or Perform a logical shift right of `Rsrc1` by the immediate value bits and store in `Rdst`.

### MOVE - Move to register

- `MOVE Rdst, Rsrc // Rdst = Rsrc`
- `MOVE Rdst, Imm // Rdst = Imm`

Move the value of `Rsrc` into `Rdst` or move the immediate value into `Rdst`.

### ST - Store data to memory

- `ST Rsrc, Rdst, offset // *[Rdst + offset] = Rsrc`

Store the value of `Rsrc` to the memory address contained in `Rdst` by `offset`.

Remember that addresses are *units* of 32 bit words and that registers are 16 bits in size. This means that if we store the value of a register at an address, the value is written into the lower 16 bits of the 32 bit value. The upper 16 bits contain the program counter (11 bits in size) shifted left by 5 bits. Note that the program counter is expressed in words and not bytes.

### LD - Load data from memory

- `LD Rdst, Rsrc, offset // Rdst = *[Rsrc + offset]`

Load data from the memory location contained in `Rsrc` plus `offset` into `Rdst`.

### JUMP - Jump to an absolute address

- `JUMP Rdst`
- `JUMP ImmAddr`
- `JUMP Rdst, Condition`
- `JUMP ImmAddr, Condition`

Jump to the address specified in `Rdst`, jump to an immediate address or jump based on a condition. The condition can be `EQ` or `OV`. Within the ULP co-processor there is the notion of an arithmetic unit that is used to perform numeric operations. There will always be the notion of the “last” arithmetic operation performed. The condition is relative to that operation. The “`EQ`” means that the result of the last arithmetic operation was zero while “`OV`” means that the result of the last arithmetic operation was an overflow.

### JUMPR - Jump relative with condition

- `JUMPR Step, Threshold, Condition`

Jump a relative number of bytes from current position based on a threshold comparison of `R0`.



**JUMPS - Jump relative based on stage count**

The condition can be one of EQ, LT, GT

**STAGE\_RST - Reset the stage count register**

- STAGE\_RST

Reset the stage count register to 0.

**STAGE\_INC - Increment the stage count register**

- STAGE\_INC Value

Add the value to the stage count register.

**STAGE\_DEC - Decrement the stage count register**

- STAGE\_DEC Value

Subtract the value from the stage count register.

**HALT - End the program**

- HALT

**WAKE - Wakeup the chip**

- WAKE

**SLEEP - Set the ULP wakeup timer period**

- SLEEP sleep\_reg

**WAIT - Wait some number of cycles**

- WAIT Cycles

## TSENS - Do measurement with the temperature sensor

- TSENS Rdst, Wait\_Delay

## ADC - Do measurement with ADC

- ADC Rdst, Sar\_sel, Mux

## REG\_RD - Read from peripheral register

- `REG_RD Addr, High, Low // R0 = *(RFC_BASE + address)[high:low]`

Read from an RTC peripheral register. This instructions needs some special explanation. First let us understand that a peripheral register is 32 bits in size. We can think of these bits as having ordinal numbers and think about bit 0, bit 1, ... , bit 31. Now consider a contiguous range of bits. For example bit 7, bit 6, bit 5 and bit 4. We can describe this using the notation [7:4] or generically [high:low] where high is the high bit in the range low is the low bit in the range. As such, the whole of the 32bits could be described as [31:0].

Now let us remember that a register in the ULP co-processor is only 16 bits in size which means that we can not load the complete 32bit value of a peripheral register into a ULP co-processor register. Instead, we can only load part of the peripheral register. Using the REG\_RD instruction, we specify the address of the 32 bit peripheral register we wish to load and then specify the high and low parts of the expression. For example, `REG_RD 0x120, 7, 4` will load the contiguous bits [7:4] of the 32bit value found at register 0x120 into R0.

Some macros are defined which simplify the use of this function. These are:

- `READ_RTC_REG(rtc_reg, low_bit, bit_width)` – Read a register start at the low bit for the width.
- `READ_RTC_FIELD(rtc_reg, field)` – Read a named field from a named register.

These macros are defined in `<soc/soc_ulp.h>`.

## REG\_WR - Write to peripheral register

- `REG_WR Addr, High, Low, Data`

## ULP co-processor assembler coding

Working in assembler is a task that I performed over 30 years ago and hadn't performed since. That meant that I had to re-learn a whole bunch of techniques and tips to get running. I'm going to assume that assembly programming is new to you too.

Think of an assembler similar to creating high level language programs. We use an editor to edit a source file and then compile the source. In a language like C, each statement is compiled into a series of executable instructions to achieve the task. In assembly programming, there is a one to one correspondence between the coded "statements" and the instructions produced. This means that when you code an assembler instruction, we could actually predict with a high degree of accuracy what the resulting binary would contain. In a language like C, we compile source code. For assembler, we use a new noun called an "assembler" as I "I ran my source through an assembler".

We edit our source files as files ending in ".s".

Within the source we have a variety of components available to us.

We can use the C pre-processor and perform `#include` and `#defines`.

We define a label with the format `{name}:`. This marks the current memory location with the symbolic name so that we can refer to it later.

Instructions are commonly indented with a tab character.

We also have some control instructions which affect the assembly. These instructions begin with a period. They are:

- `.long <numeric>` – Define a 32bit numeric value at this location.
- `.global <name>` – Define a symbolic name that will be exposed from this assembly and referencable by other code. A header file will be created with the name `ulp_{sourceFileName}.h` which will contain definitions of each of the globals exported. However, some care needs to be had. If we define:

```
.global xyz
```

Then we are exposing the label called `xyz`. In the generated header file, we will find an entry of the form:

```
extern uint32_t ulp_xyz;
```

One might think that the variable `ulp_xyz` will contain the address of the label called `xyz` but that is wrong. The address of the variable (i.e. `&ulp_xyz`) is the address of the label and the variable `ulp_xyz` thus is the 32bit value of the data contained at that address.

- `.set <name> <value>` – Define a constant value with the symbol name.
- `.text` – Define the following as existing in the text section of the application.
- `.bss` – Define the following as zero initialized data.

## Loading and starting a ULP co-processor application

Once we have compiled a ULP co-processor application, we end up with a binary file that is ready for execution. The binary file is automatically linked with your ESP32 application and exists within the flash memory address space. When you prepared your ULP co-processor app, you modified the `component.mk` file and gave the application a name using the `ULP_APP_NAME` definition. This produced two symbols called:

- `_binary_{ULP_APP_NAME}_bin_start` – Start of ULP app in flash memory.
- `_binary_{ULP_APP_NAME}_bin_end` – End of ULP app in flash memory

Knowing these values, we can load the ULP co-processor map into slow memory address space in preparation for its execution. To do this, we use the `ulp_load_binary()` function.

For example:

```
extern const uint8_t ulp_start[] asm("_binary_ulp_MYAPP_bin_start");
extern const uint8_t ulp_end[]   asm("_binary_ulp_MYAPP_bin_end");
esp_err_t err = ulp_load_binary(
    0,
    ulp_main_bin_start,
    (ulp_main_bin_end - ulp_main_bin_start) / sizeof(uint32_t)
);
```

The third parameter takes a little bit of explanation. The ULP APIs don't think in terms of bytes but instead think in terms of ULP co-processor words where each word is 32bits. The `ulp_load_binary()` function takes the number of words to load.

Once the application is loaded into slow memory, we can then start it with a call to `ulp_run()`. This takes the instruction to start on which is again a word index. For example:

```
ulp_run((&ulp_entry - RTC_SLOW_MEM)/4);
```

See also:

- `ulp_load_binary`
- `ulp_run`

## Waking up the ULP co-processor

There are designs where we want the ULP co-processor to enter a deep sleep mode. Perhaps we want the ULP co-processor to wake up periodically and sense some input. It doesn't make sense to have the ULP co-processor soak up CPU busy waiting. We can arrange for the ULP co-processor to fall asleep and self awake after a given time period.

We do this by setting one of the `SENS_ULP_CP_SLEEP_CYCn_REG` peripheral registers with the time to wake up. Once the register is set, we can then execute the `SLEEP` instruction specifying which of the registers to use as the one to wake us up. There are five registers available to us. For example:

```
SLEEP 2
```

would indicate that the ULP co-processor will sleep until the interval contained in the `SENS_ULP_CP_SLEEP_CYC2_REG`.

The ULP co-processor goes to sleep when the `HALT` instruction is executed.

## Peripheral registers for ULP co-processor

### `SENS_ULP_CP_SLEEP_CYC0_REG`

Address: 0x3FF4 8818

Timer setting 0. Invoke `SLEEP 0` to use this register.

### `SENS_ULP_CP_SLEEP_CYC1_REG`

Address: 0x3FF4 881C

Timer setting 1. Invoke `SLEEP 1` to use this register.

### `SENS_ULP_CP_SLEEP_CYC2_REG`

Address: 0x3FF4 8820

Timer setting 2. Invoke `SLEEP 2` to use this register.

### `SENS_ULP_CP_SLEEP_CYC3_REG`

Address: 0x3FF4 8824

Timer setting 3. Invoke SLEEP 3 to use this register.

**SENS\_ULP\_CP\_SLEEP\_CYC4\_REG**

Address: 0x3FF4 8828

Timer setting 4. Invoke SLEEP 4 to use this register.

**SENS\_SAR\_START\_FORCE\_REG**

Address: 0x3FF4 882C

Operation flags for startup.

Field	Bits	Description
SENS_PC_INIT	[11:21]	Program counter start address.
SENS_ULP_CP_START_TOP	9	ULP co-processor is active when value is 1.
SENS_ULP_CP_FORCE_START_TOP	8	1 – ULP co-processor started by explicit request. 0 – ULP co-processor started by timer.

RTC GPIO Num	GPIO Num
RTC GPIO 0	GPIO 36
RTC GPIO 1	GPIO 37
RTC GPIO 2	GPIO 38
RTC GPIO 3	GPIO 39
RTC GPIO 4	GPIO 34
RTC GPIO 5	GPIO 35
RTC GPIO 6	GPIO 25
RTC GPIO 7	GPIO 26
RTC GPIO 8	GPIO 33
RTC GPIO 9	GPIO 32
RTC GPIO 10	GPIO 4
RTC GPIO 11	GPIO 0
RTC GPIO 12	GPIO 2
RTC GPIO 13	GPIO 15
RTC GPIO 14	GPIO 13
RTC GPIO 15	GPIO 12
RTC GPIO 16	GPIO 14
RTC GPIO 17	GPIO 27

# Electronics

## Transistors as switches

If we consider that a GPIO pin can produce a signal of high or low we see that the signal can be used to perform work. However there is a maximum current that can be drawn from any given I/O pin. If, for example, we wished to attach a device to a pin which would draw more current than the pin is rated to supply, we may very easily damage our ESP32. This is where a transistor can come into play. A transistor can be thought of as an electronic switch. A transistor has three pins labeled emitter, base and collector. If a small current flows between base and emitter a correspondingly higher current will be allowed to flow between collector and emitter. There are two types of transistor we will come across called NPN and PNP. The difference between them is whether or not the "switch" is triggered by a high signal or a low signal. The following is the schematic symbol for an NPN transistor. Normally we connect the emitter to ground and a load between the collector and +ve. If we then connect the base to the output of an I/O pin (through a resistor), then when the pin goes high, a small current will flow between B and E and a much higher current will flow between C and E.

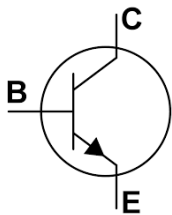

For the other type of transistor (PNP) whose symbol is shown in the following diagram, the emitter is usually connected to +ve and the collector to the load and then ground. With the base pin connected to a GPIO (through a resistor), when the base goes low, the small current flowing from the emitter through the base will be greatly amplified as the current flowing through the emitter to the collector.

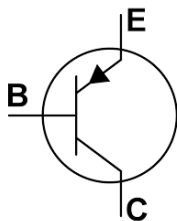

By using a transistor, we are no longer directly drawing load through the GPIO pin but instead simply using the signal present on the pin to energize the transistor.

Common transistors that can easily be obtained include:

Name	Type	Style
2N3904 (Signal transistor) – 200mA max current	NPN	TO-92
2N3906 (Signal transistor)	PNP	TO-92
PN2222	NPN	TO-92
TIP120 – 5A max current	NPN	TO-220
TIP125 – 5A max current	PNP	TO-220
BC547 – 100mA max current	NPN	TO-92
BC557 – 100mA max current	PNP	TO-92
2N3055 – 15A max current	NPN	TO-3

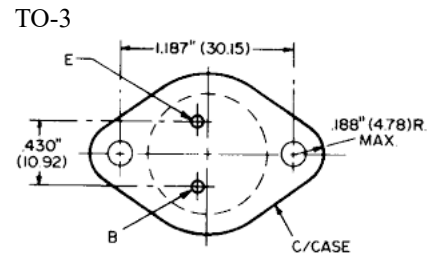
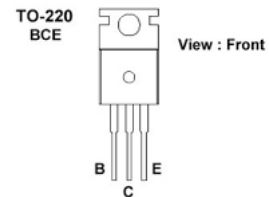
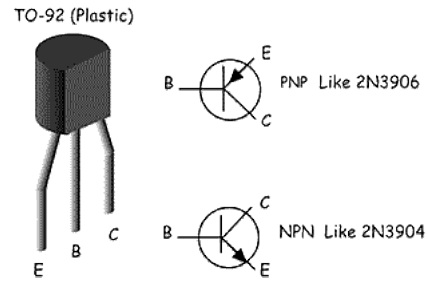

See also:

- [2N3904 Data Sheet](#)
- [2N3906 Data Sheet](#)
- [PN2222 Data Sheet](#)
- [TIP120 Data Sheet](#)
- [TIP125 Data Sheet](#)
- [BC547 Data Sheet](#)
- [BC557 Data Sheet](#)
- [You Tube: Electronic Basics #22: Transistor \(BJT\) as a switch](#)
- [Using bipolar transistors as switches](#)

## Logic Level Shifting

We have already read that the ESP32 GPIO pins are 3.3V tolerant. This means that the maximum input voltage must be 3.3V. If you go higher than that, you are at risk for frying your device. But what if we have a peripheral device that outputs a 5V signal? Conversely, the maximum output voltage on a Pi GPIO is 3.3V. If we feed that as input



to a peripheral that is expecting a 5V input, there is no assurance that it will detect the signal correctly. Fortunately there is a solution in a circuit called a logic level shifter. This circuit can convert a 3.3V signal to a 5V signal and can also convert a 5V signal to a 3.3V signal.

The module takes as input +ve and ground of the high level and +ve and ground of the low level and provides bi-directional switching.

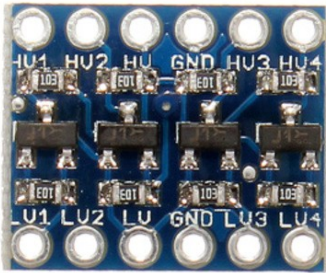

If you don't have access to such logic level circuits, an alternative solution is to create a voltage divider. This will protect 3V Pi inputs from over voltage from a 5V source. This is a simple circuit made with two resistors. A higher voltage is provided to input than output and using a correct combination of resistors, the input voltage is proportionally scaled to the output voltage.

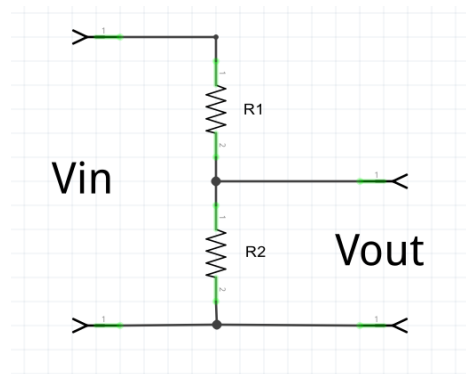

There is an equation available to us:

$$V_{out} = \frac{V_{in} \times R2}{R1 + R2}$$

As an example of a solution to this equation, if  $V_{in}$  is 5V and we want  $V_{out}$  to be 3.3V and choose  $1K\Omega$  for  $R2$  then ...

$$3.3 = \frac{1000}{R1 + 1000} \times 5$$

Which evaluates to  $R1$  having a value of  $515\Omega$ . We can use a higher value for  $R1$  but not lower.

Expressing the equation in a different order we have:

$$R1 = \frac{(V_{in} - V_{out}) \times R2}{V_{out}}$$

See also:

- Sparkfun – [Bi-Directional Logic Level Converter Hookup Guide](#)
- Wikipedia – [Voltage divider](#)

## Projects

### JerryScript library for ESP32

JerryScript is JavaScript for embedded devices including the ESP32. However, just like JavaScript on other platforms, it provides only the language. What this means is that there are no libraries of higher functions supplied by default. Projects such as IoT.js would be perfect, but it appears that their requirements and dependencies are currently too function rich for a trivial port to ESP32.

As a result of that, we now look to see if we can't do something more pragmatic. We will borrow wherever possible from the semantics and descriptions of Node.js which is the industry de-facto standard.

### The "require" capability

The concept is that we can load "modules" by name. A module is the dynamic sourcing of function which returns a JavaScript object that services that function.

Generically, we will code:

```
let myVar = require("<Module Name>");
```

Our implementation will be general enough to return built-in modules as well as external modules.

See also:

- JerryScript

## API Reference

Now we have a mini reference to the syntax of many of the ESP32 exposed APIs as well as related libraries. Do not use this reference exclusively. Please also refer to the published Espressif SDK Programming Guide and other sources of literature. Part of the purpose of recreating this quick listing is so that it can be cross referenced in the examples as well as serving as a place where notes about using an API in the context of an ESP32 can be captured.

Some acronyms and other names are used in the naming of APIs and may need some explanation to fully appreciate them:

- dhcpc – DHCP client
- dhcps – DHCP server
- softap – Access point implemented in software
- wps – WiFi Protected Setup
- sntp – Simple Network Time Protocol
- mdns – Multi-cast Domain Name System
- uart – Universal asynchronous receiver/transmitter
- pwm – Pulse width modulation

## Configuration, status and operational retrieval

There are certain APIs available to us that can be used to interrogate the operation of an ESP32 and some of its distinct parts and components. The detailed documentation for these APIs are found in the corresponding links ... but here we list their existence and brief description of what they provide:

- system\_get\_time - Get the system time measured in microseconds since last device start-up.
- esp\_chip\_info - Get information about the chip.
- esp\_get\_free\_heap\_size - Get the amount of free heap size.
- esp\_get\_idf\_version - Get the version of the ESP-IDF in use.
- esp\_wifi\_scan\_get\_ap\_records - Retrieve the access points found in a previous scan.
- esp\_wifi\_scan\_get\_ap\_num - Retrieve the count of found access points from a previous scan.
- esp\_wifi\_get\_auto\_connect - Determine whether or not auto connect at boot is enabled.
- esp\_wifi\_get\_bandwidth - Get the current bandwidth setting.
- esp\_wifi\_get\_channel - Get the current channel.
- esp\_wifi\_get\_config - Retrieve the current connection information associated with the specified WiFi interface.
- esp\_wifi\_get\_country - Retrieve the currently configured WiFi country.
- esp\_wifi\_get\_mac - Retrieve the current MAC address for the interface.
- esp\_wifi\_get\_mode - Get the WiFi operating mode.
- esp\_wifi\_get\_promiscuous
- esp\_wifi\_get\_protocol - Get the 802.11 protocol (b/g/n).
- esp\_wifi\_get\_ps - Get the power save type.
- esp\_wifi\_get\_station\_list - Get the list of stations connected to ESP32 when it is behaving as an access point.
- tcpip\_adapter\_get\_ip\_info
- tcpip\_adapter\_get\_sta\_list
- tcpip\_adapter\_get\_wifi\_if

## Arduino Mapping

The Arduino APIs are a library of functions available within the Arduino ecosystem.

There may be times when we want to port an Arduino library to the ESP-IDF environment. This section lists some of the more common Arduino APIs and how they can be mapped to the ESP-IDF.

### bitRead

```
bitRead(x, n)
```

The equivalent is:

```
(x & 1<<n) != 0
```

### bitWrite

```
bitWrite(x, n, b)
```

```
x = (x & ~(1<<n)) | (b << n)
```

### delay

```
delay(ms)
```

The equivalent in ESP-IDF is:

```
vTaskDelay(ms/portTICK_PERIOD_MS)
```

See also:

- `vTaskDelay`
- [Arduino – delay\(\)](#)

### digitalWrite

```
digitalWrite(pin, value)
```

The equivalent in ESP-IDF is:

```
gpio_set_level()
```

Parameter mappings:

HIGH	1
LOW	0

See also:

- `gpio_set_level`
- [Arduino – digitalWrite\(\)](#)

## pinMode

`pinMode(pin, mode)`

The equivalent in ESP-IDF is:

`gpio_set_direction()`

Parameter mappings:

<code>mode=INPUT</code>	<code>GPIO_MODE_INPUT</code>
<code>mode=OUTPUT</code>	<code>GPIO_MODE_OUTPUT</code>
<code>mode=INPUT_PULLUP</code>	<code>GPIO_MODE_INPUT</code> with an additional call to <code>gpio_set_pull_mode()</code> .

See also:

- `gpio_set_direction`
- [Arduino – pinMode\(\)](#)

## SPI.begin

`SPI.begin()`

The equivalent in ESP-IDF is:

```
spi_bus_initialize();  
spi_bus_add_device();
```

See also:

- `spi_bus_add_device`
- `spi_bus_initialize`
- [Arduino – SPI.begin\(\)](#)

## SPI.setBitOrder

`SPI.setBitOrder`

The equivalent in ESP-IDF is:

```
spi_bus_add_device()
```

and setting the flags properties. The default is MSB but within the flags we can specify LSB for either or both of the RX or TX.

See also:

- `spi_bus_add_device`
- [Arduino – SPI.setBitOrder\(\)](#)

### **SPI.setClockDivider**

`SPI.setClockDivider()`

The equivalent in ESP-IDF is:

`spi_bus_add_device()`

and setting the clock speed in Hz.

See also:

- `spi_bus_add_device`
- [Arduino – SPI.setClockDivider\(\)](#)

### **SPI.setDataMode**

`SPI.setDataMode()`

The equivalent in ESP-IDF is:

`spi_bus_add_device()`

and setting the `mode` property of the structure.

See also:

- `spi_bus_add_device`
- [Arduino – SPI.setDataMode\(\)](#)

### **SPI.transfer**

`SPI.transfer(val)`

`SPI.transfer(buffer, size)`

The equivalent in ESP-IDF is:

`spi_device_transmit()`

See also:

- `spi_device_transmit`
- [Arduino – SPI.transfer\(\)](#)

### **Wire.begin**

Initialize the I2C interface.

`Wire.begin()`

`Wire.begin(address)`

The equivalent ESP-IDF is

```
i2c_cmd_handle_t cmd = i2c_cmd_link_create();
i2c_master_start(cmd);
i2c_master_write_byte(cmd, (address << 1) | I2C_MASTER_WRITE, 1 /* expect ack */);
```

### **Wire.beginTransmission**

Wire.beginTransmission(address)

The equivalent ESP-IDF is:

```
i2c_cmd_handle_t cmd = i2c_cmd_link_create();
i2c_master_start(cmd);
i2c_master_write_byte(cmd, (address << 1) | I2C_MASTER_WRITE, 1 /* expect ack */);
```

### **Wire.endTransmission**

Wire.endTransmission()

The equivalent ESP-IDF is:

```
i2c_master_stop(cmd);
i2c_master_cmd_begin(0, cmd, 0);
i2c_cmd_link_delete(cmd);
```

### **Wire.read**

Wire.read()

The equivalent ESP-IDF is:

```
i2c_master_read(cmd, data, length, ack)
i2c_master_read_byte(cmd, data, ack)
```

### **Wire.requestFrom**

Wire.requestFrom(address, quantity)

### **Wire.write**

Wire.write(string)  
Wire.write(data, length)

The equivalent ESP-IDF is:

```
i2c_master_write(cmd, data, length, 1);
```

## **FreeRTOS API reference**

See also:

- [Using FreeRTOS](#)

### **portENABLE\_INTERRUPTS**

Enable interrupts and context switching.

## portDISABLE\_INTERRUPTS

Disable interrupts and context switching.

## xPortGetCoreID

This is a macro that returns the current core ID on which we are running.

```
uint32 xPortGetCoreID()
```

Since the ESP32 has two cores, the result will either only ever be 0 or 1.

## pvPortMalloc

Allocate storage.

```
void *pvPortMalloc(size_t size)
```

See also:

- `malloc`

## pvPortFree

Release storage.

```
void vPortFree(void *data)
```

## xPortGetFreeHeapSize()

Return the amount of storage that is free on the heap. Equivalent to calling

```
heap_caps_get_free_size(MALLOC_CAP_DEFAULT).
```

See also:

- `heap_caps_get_free_size`

## xEventGroupClearBits

Clear one or more bits in an event group.

```
EventBits_t xEventGroupClearBits(  
    EventGroupHandle_t eventGroup,  
    const EventBits_t bitsToClear)
```

- `eventGroup` – The event group that contains the bits to be cleared.
- `bitsToClear` – The set of bits to be cleared within the event group.

Includes:

- `#include <freertos/FreeRTOS.h>`



- `#include <freertos/event_groups.h>`

See also:

- Blocking and synchronization within FreeRTOS

### **xEventGroupCreate**

Create a new FreeRTOS event group.

```
EventGroupHandle_t xEventGroupCreate()
```

Includes:

- `#include <freertos/FreeRTOS.h>`
- `#include <freertos/event_groups.h>`

See also:

- Blocking and synchronization within FreeRTOS

### **xEventGroupCreateStatic**

```
EventGroupHandle_t xEventGroupCreateStatic(  
    StaticEventGroup_t* pxEventGroupBuffer)
```

Create an event group where the storage needed for the group is supplied by the caller as opposed to dynamically allocated from the heap.

### **vEventGroupDelete**

Delete an event group.

```
void vEventGroupDelete(EventGroupHandle_t eventGroup)
```

Includes:

- `#include <freertos/event_groups.h>`

### **xEventGroupSetBits**

Set one or more bits in an event group.

```
EventBits_t xEventGroupSetBits(  
    EventGroupHandle_t eventGroup,  
    const EventBits_t bitsToSet)
```

- `eventGroup` – The event group that contains the bits to be set.

- `bitsToSet` – The set of bits to be set within the event group. This is a bit mask.

Includes:

- `#include <freertos/FreeRTOS.h>`
- `#include <freertos/event_groups.h>`

See also:

- Blocking and synchronization within FreeRTOS

## **xEventGroupWaitBits**

Block waiting for one or more "bits" to become set.

```
EventBits_t xEventGroupWaitBits(
    const EventGroupHandle_t eventGroup,
    const EventBits_t        bitsToWaitFor,
    const BaseType_t         clearOnExit,
    const BaseType_t         waitForAllBits,
    TickType_t               ticksToWait)
```

Calling this function can cause the caller to block until bits are set or a timeout is met.

Bits can be set through `xEventGroupSetBits()`.

- `eventGroup` – The event group that references the bits to be watched.
- `bitsToWaitFor` – The set of bits within the event group that we are waiting upon. This is a bit mask.
- `clearOnExit` – Should the bits that we are waiting on be cleared automatically when set and this method returns?
- `waitForAllBits` – Should we unblock on the first bit that is set that we are watching for or alternatively should we wait on all the bits being set?
- `ticksToWait` – How many ticks should we wait for before returning? This provides a timeout (if needed). The RTOS variable "`portMAX_DELAY`" can be used to specify that we wish to wait indefinitely.

Includes:

- `#include <freertos/FreeRTOS.h>`
- `#include <freertos/event_groups.h>`

See also:

- `xEventGroupSetBits`
- Blocking and synchronization within FreeRTOS

## xQueueAddToSet

Add a queue to the set of queues monitored by this queue set.

```
 BaseType_t xQueueAddToSet(
    QueueSetMemberHandle_t xQueueOrSemaphore,
    QueueSetHandle_t xQueueSet)
```

See also:

- [xQueueCreateSet](#)
- [xQueueRemoveFromSet](#)
- [xQueueSelectFromSet](#)

## xQueueCreate

Create a queue for holding items.

```
 QueueHandle_t xQueueCreate(
    UBaseType_t uxQueueLength,
    UBaseType_t uxItemSize)
```

This call creates a queue for holding queue items. The maximum number of items that the queue can hold is supplied as well as the size of each item in a queue. On return, a handle to the new queue is supplied or has a value of NULL on error.

If the queue is no longer needed, it can be deleted with a call to `vQueueDelete()`.

- `uxQueueLength` – The maximum number of items that the queue can contain.
- `uxItemSize` – The size in bytes reserved for each element in the queue.

Includes:

- `#include <freertos/FreeRTOS.h>`
- `#include <freertos/queue.h>`

See also:

- [vQueueDelete](#)
- [xQueueCreate](#)
- [xQueueSendToBack](#)

## xQueueCreateSet

Create a queue set.

```
 QueueSetHandle_t xQueueCreateSet( const UBaseType_t uxEventQueueLength)
```

The `uxEventQueueLength` must be at least the size of all the queues that will be concurrently watched by this queue set.

See also:

- `xQueueAddToSet`
- `xQueueRemoveFromSet`
- `xQueueSelectFromSet`

### **xQueueCreateStatic**

Create a queue for holding items but allow the application to own the management of queue records.

```
QueueHandle_t xQueueCreateStatic(  
    UBaseType_t uxQueueLength,  
    UBaseType_t uxItemSize,  
    uint8_t *queueStorageBuffer,  
    StaticQueue_t pxQueueBuffer)
```

Includes:

- `#include <freertos/FreeRTOS.h>`
- `#include <freertos/queue.h>`

### **vQueueDelete**

Delete a previously created queue.

```
void vQueueDelete(xQueueHandle xQueue)
```

Includes:

- `#include <freertos/FreeRTOS.h>`
- `#include <freertos/queue.h>`

See also:

- `xQueueCreate`
- `xQueueCreateStatic`

### **xQueueGenericReceive**

```
BaseType_t xQueueGenericReceive(  
    QueueHandle_t xQueue,  
    void* const pvBuffer,  
    TickType_t xTicksToWait,  
    const BaseType_t xJustPeek)
```

### **uxQueueMessagesWaiting**

Return the count of messages on the queue.

```
UBaseType_t uxQueueMessagesWaiting(QueueHandle_t xQueue)
```

The return is the number of messages currently on the queue.

Includes:

- `#include <freertos/FreeRTOS.h>`
- `#include <freertos/queue.h>`

### **xQueueOverwrite**

```
BaseType_t xQueueOverwrite(QueueHandle_t xQueue, const void *pvItemToQueue)
```

Includes:

- `#include <freertos/FreeRTOS.h>`
- `#include <freertos/queue.h>`

### **xQueuePeek**

```
BaseType_t xQueuePeek(QueueHandle_t xQueue, void* pvBuffer, TickType_t xTicksToWait)
```

Includes:

- `#include <freertos/FreeRTOS.h>`
- `#include <freertos/queue.h>`

### **xQueuePeekFromISR**

```
BaseType_t xQueuePeekFromISR(QueueHandle_t xQueue, void* const pvBuffer)
```

### **xQueueReceive**

Retrieve an item from the head of the queue.

```
BaseType_t xQueueReceive(QueueHandle_t xQueue, void* pvBuffer, TickType_t xTicksToWait)
```

The `xQueue` is the handle to the queue we wish to receive from. The `pvBuffer` is a pointer to storage that will receive the item from the queue. The `xTicksToWait` is how long we wish to wait for an item to become available assuming the queue is empty. Specifying 0 means return immediately while specifying `portMAX_DELAY` means block indefinitely.

The return is `pdPASS` if we receive an item or `errQUEUE_EMPTY` if no item was retrieved.

Includes:

- `#include <freertos/FreeRTOS.h>`
- `#include <freertos/queue.h>`

### **xQueueReceiveFromISR**

```
 BaseType_t xQueueReceiveFromISR(  
     QueueHandle_t xQueue,  
     void*        pvBuffer,  
     BaseType_t*  pxHigherPriorityTaskWoken  
 )
```

### **xQueueRemoveFromSet**

```
 BaseType_t xQueueRemoveFromSet(  
     QueueSetMemberHandle_t xQueueOrSemaphore,  
     QueueSetHandle_t       xQueueSet)
```

### **xQueueReset**

```
 BaseType_t xQueueReset(QueueHandle_t xQueue)
```

Includes:

- `#include <freertos/FreeRTOS.h>`
- `#include <freertos/queue.h>`

### **xQueueSelectFromSet**

Watch a queue set for a member becoming ready.

```
 QueueSetMemberHandle_t xQueueSelectFromSet(  
     QueueSetHandle_t xQueueSet,  
     const TickType_t xTicksToWait)
```

The return is the handle of the queue which is ready for reading without blocking.

See also:

- `xQueueAddToSet`
- `xQueueCreateSet`
- `xQueueRemoveFromSet`

## **xQueueSelectFromSetFromISR**

`QueueSetMemberHandle_t xQueueSelectFromSetFromISR(QueueSetHandle_t xQueueSet)`

## **xQueueSend**

This is a macro for backwards compatibility only. Do not use for new projects.

```
BaseType_t xQueueSend(
    QueueHandle_t xQueue,
    const void*   pvItemToQueue,
    TickType_t    xTicksToWait
);
```

## **xQueueSendFromISR**

This is a macro for backwards compatibility only. Do not use for new projects. Use

`xQueueSendToBackFromISR()`.

```
BaseType_t xQueueSendFromISR(
    QueueHandle_t xQueue,
    const void*   pvItemToQueue,
    BaseType_t*   pxHigherPriorityTaskWoken
);
```

## **xQueueSendToBack**

Place an item at the end of the queue.

```
BaseType_t xQueueSendToBack(
    QueueHandle_t xQueue,
    const void*   pvItemToQueue,
    TickType_t    xTicksToWait)
```

The `xQueue` is the reference to the queue into which we are going to place the item. The `pvItemToQueue` is a pointer to the item we are going to copy into the queue. Note that this is indeed a copy and not saved as a reference. The `xTicksToWait` is how long we are prepared to wait if the queue is currently full. Specifying 0 returns immediately while `portMAX_DELAY` blocks indefinitely.

On return the value `pdPASS` indicates that the message was queued while `errQUEUE_FULL` indicates that the message was not queued and we timed out waiting for space to become available.

Includes:

- `#include <freertos/FreeRTOS.h>`
- `#include <freertos/queue.h>`

### **xQueueSendToBackFromISR**

Place an item at the end of the queue.

```
 BaseType_t xQueueSendToBackFromISR(
    QueueHandle_t xQueue,
    const void* pvItemToQueue,
    BaseType_t* pxHigherPriorityTaskWoken
)
```

This function is an ISR safe version of the `xQueueSendToBack()` function. The `xQueue` is the reference to the queue into which we are going to place the item. The `pvItemToQueue` is a pointer to the item we are going to copy into the queue. Note that this is indeed a copy and not saved as a reference.

The `pxHigherPriorityTaskWoken` is a pointer to a flag that is set on return. If its value is `pdTRUE` then a higher priority task is ready and a context switch is possible. It can be `NULL` to be ignored.

The return is `pdPASS` if the item was queued otherwise `errQUEUE_FULL` to indicate that the queue was full.

Includes:

- `#include <freertos/FreeRTOS.h>`
- `#include <freertos/queue.h>`

See also:

- [xQueueSendToBackFromISR](#)

### **xQueueSendToFront**

```
 BaseType_t xQueueSendToFront(
    QueueHandle_t xQueue,
    const void * pvItemToQueue,
    TickType_t xTicksToWait)

```

The `xQueue` is the reference to the queue into which we are going to place the item. The `pvItemToQueue` is a pointer to the item we are going to copy into the queue. Note that



this is indeed a copy and not saved as a reference. The `xTicksToWait` is how long we are prepared to wait if the queue is currently full. Specifying 0 returns immediately while `portMAX_DELAY` blocks indefinitely.

On return the value `pdPASS` indicates that the message was queued while `errQUEUE_FULL` indicates that the message was not queued and we timed out waiting for space to become available.

Includes:

- `#include <freertos/FreeRTOS.h>`
- `#include <freertos/queue.h>`

### **xQueueSendToFrontFromISR**

```
 BaseType_t xQueueSendToFrontFromISR(  
     QueueHandle_t xQueue,  
     const void*   pvItemToQueue,  
     BaseType_t*   pxHigherPriorityTaskWoken  
 )
```

### **uxQueueSpacesAvailable**

```
 UBaseType_t uxQueueSpacesAvailable(QueueHandle_t xQueue)
```

Includes:

- `#include <freertos/FreeRTOS.h>`
- `#include <freertos/queue.h>`

### **xRingbufferAddToQueueSetRead**

```
 BaseType_t xRingbufferAddToQueueSetRead(  
     RingbufHandle_t ringbuf,  
     QueueSetHandle_t xQueueSet)
```

### **xRingbufferAddToQueueSetWrite**

Add the ring buffer as an indicator item to the queue set.

```
 BaseType_t xRingbufferAddToQueueSetWrite(  
     RingbufHandle_t ringbuf,  
     QueueSetHandle_t xQueueSet)
```

Making this call adds the ring buffer to the queue set such that a write to the ring buffer will cause a trigger of any queue set being watched.

See also:

- `xQueueCreateSet`
- `xQueueSelectFromSet`

### **xRingbufferCreate**

Create a new ring buffer.

```
RingbufHandle_t xRingbufferCreate(  
    size_t length,  
    ringbuf_type_t type)
```

- `length` – The size in bytes that we wish to allocate for the ring buffer.
- `type` – The type of ring buffer with respect to how wrapping is to occur. The choices are:
  - `RINGBUF_TYPE_NOSPLIT` – Do not allow splits of data.
  - `RINGBUF_TYPE_ALLOWSPPLIT` – Allow splits of data.
  - `RINGBUF_TYPE_BYTEBUF` – Byte buffer.

### **vRingbufferDelete**

Delete a ring buffer.

```
void vRingbufferDelete(RingbufHandle_t ringbuf)
```

Delete a ring buffer previously created with a call to `xRingbufferCreate()`.

### **xRingbufferGetMaxItemSize**

Get the maximum size of an item that will fit within the remaining space in the ring buffer.

```
size_t xRingbufferGetMaxItemSize(RingbufHandle_t ringbuf)
```

### **xRingBufferPrintInfo**

Dump the internals of the ring buffer.

```
void xRingbufferPrintInfo(RingbufHandle_t ringbuf)
```

## xRingbufferReceive

Retrieve an item from the ring buffer.

```
void* xRingbufferReceive(  
    RingbufHandle_t ringbuf,  
    size_t* item_size,  
    TickType_t ticks_to_wait)
```

- `ringbuf` – The ringbuf to receive an item from.
- `item_size` – The size of the item received.
- `ticks_to_wait` – How long to wait. Specify `portMAX_DELAY` for an indefinite block.

The return from this call is a pointer to storage that is the next item within the buffer. Since items in a ring buffer can be of distinct sizes, the `item_size` variable is populated with the size of the data in this returned record instance. We must subsequently call `vRingbufferReturnItem()` to release the storage when we are finished with it.

## xRingbufferReceiveFromISR

```
void* xRingbufferReceiveFromISR(  
    RingbufHandle_t ringbuf,  
    size_t* item_size)
```

## xRingbufferReceiveUpTo

Return data from the ring buffer up to a maximum size.

```
void* xRingbufferReceiveUpTo(  
    RingbufHandle_t ringbuf,  
    size_t* item_size,  
    TickType_t ticks_to_wait,  
    size_t wanted_size)
```

## xRingbufferReceiveUpToFromISR

```
void* xRingbufferReceiveUpToFromISR(  
    RingbufHandle_t ringbuf,  
    size_t* item_size,  
    size_t wanted_size)
```

## xRingbufferRemoveFromQueueSetRead

```
BaseType_t xRingbufferRemoveFromQueueSetRead(  
    RingbufHandle_t ringbuf,  
    QueueSetHandle_t xQueueSet)
```

## xRingbufferRemoveFromQueueSetWrite

```
BaseType_t xRingbufferRemoveFromQueueSetWrite(  
    RingbufHandle_t ringbuf,  
    QueueSetHandle_t xQueueSet)
```

## vRingbufferReturnItem

Release the storage for a previously retrieved item.

```
void vRingbufferReturnItem(  
    RingbufHandle_t ringbuf,  
    void* item)
```

When we make a call to `xRingbufferReceive()` we are supplied a pointer to storage that is contained within the ring buffer. That storage is not released until we invoke `vRingbufferReturnItem()`.

## vRingbufferReturnItemFromISR

```
void vRingbufferReturnItemFromISR(  
    RingbufHandle_t ringbuf,  
    void* item,  
    BaseType_t* higher_prio_task_awoken)
```

## xRingbufferSend

Insert an item into the ring buffer.

```
BaseType_t xRingbufferSend(  
    RingbufHandle_t ringbuf,  
    void* data,  
    size_t data_size,  
    TickType_t ticks_to_wait)
```

- `ringbuf` – A ring buffer handle.
- `data` – Pointer to the data to be inserted into the buffer.
- `data_size` – Size of the data to insert into the buffer.
- `ticks_to_wait` – Ticks to wait before giving up for enough space to be available in the buffer to insert the item. This can be `portMAX_DELAY` to wait indefinitely.

## xRingbufferSendFromISR

Insert an item into the ring buffer from an ISR.

```
 BaseType_t xRingbufferSendFromISR(  
     RingbufHandle_t ringbuf,  
     void*          data,  
     size_t         data_size,  
     BaseType_t*    higher_prio_task_awoken)
```

- ringbuf – A ring buffer handle.
- data – Pointer to the data to be inserted into the buffer.
- data\_size – Size of the data to insert into the buffer.
- higher\_prio\_task\_awoken

## vSemaphoreCreateBinary

Includes:

- #include <freertos/semphr.h>

## xSemaphoreCreateCounting

Includes:

- #include <freertos/semphr.h>

## xSemaphoreCreateMutex

Create a mutex.

```
SemaphoreHandle_t xSemaphoreCreateMutex()
```

Create an instance of a semaphore.

Includes:

- #include <freertos/semphr.h>

See also:

- xSemaphoreTake
- xSemaphoreGive

## **vSemaphoreDelete**

Delete a semaphore.

```
void vSemaphoreDelete(SemaphoreHandle_t semaphore);
```

Release resources for the given semaphore.

Includes:

- `#include <freertos/semphr.h>`

## **uxSemaphoreGetCount**

### **xSemaphoreGive**

Release a mutex.

```
xSemaphoreGive(SemaphoreHandle_t semaphore)
```

Release a mutex.

Includes:

- `#include <freertos/semphr.h>`

See also:

- `xSemaphoreCreateMutex`
- `xSemaphoreTake`

### **xSemaphoreGiveFromISR**

```
xSemaphoreGive(SemaphoreHandle_t semaphore, BaseType_t *pxHigherPriorityTaskWoken)
```

Includes:

- `#include <freertos/semphr.h>`

### **xSemaphoreTake**

Take a semaphore/mutex.

```
bool xSemaphoreTake(SemaphoreHandle_t semaphore, TickType_t ticksToWait)
```

- `semaphore` – A semaphore handle.

- `ticksToWait` – How long to wait before returning due to a timeout because we didn't obtain the semaphore. The value `portMAX_DELAY` will block indefinitely. A value of 0 will return immediately, effectively polling the semaphore.

Returns true if the semaphore was taken and false otherwise.

Includes:

- `#include <freertos/semphr.h>`

See also:

- `xSemaphoreCreateMutex`
- `xSemaphoreGive`

## xTaskCreate

Create a new instance of a task.

```
BaseType_t xTaskCreate(
    pdTASK_CODE          pvTaskCode,
    const signed portCHAR* pcName,
    unsigned portSHORT   usStackDepth,
    void*                 pvParameters,
    unsigned portBASE_TYPE uxPriority,
    xTaskHandle*         pxCreatedTask)
```

- `pvTaskCode` – Pointer to the task function. In C programming, we can simply supply the name of a function or, as has been seen in some samples, the address of the name of the function. Apparently these equate to items that are close enough to be used interchangeably.
- `pcName` – Debugging name of the task.
- `usStackDepth` – Size of the stack for the task.
- `pvParameters` – Parameters for the task instance. This may be NULL.
- `uxPriority` – Priority of the task instance.
- `pxCreatedTask` – Reference to the newly created task instance. This may be passed in as NULL if no task handle is required to be returned.

In an ESP32 environment, an example, we might have:

```
void myTask(void *parms) {
    // Do something
    vTaskDelete(NULL);
}

main() {
```

```
xTaskCreate(&myTask, "myTask", 2048, NULL, 5, NULL);  
}
```

When a created task is invoked and then decides to end via a return, it is essential that the task call `vTaskDelete(NULL)` before it completes. Calling this is an indication to FreeRTOS that the task is finished and need no longer be considered for context switching. Experience seems to show that if we don't do this then the ESP32 will crash. In summary, end your return logic in your task functions with:

```
{  
    // Previous code here.  
    vTaskDelete(NULL);  
    return;  
}
```

Include:

- `#include <freertos/FreeRTOS.h>`
- `#include <freertos/task.h>`

See also:

- The architecture of a task in FreeRTOS
- `vTaskDelete`
- [xTaskCreate](#)

### **xTaskCreatePinnedToCore**

```
 BaseType_t xTaskCreatePinnedToCore(  
    TaskFunction_t pxTaskCode,  
    const char*    pcName,  
    const uint16_t usStackDepth,  
    void*          pvParameters,  
    UBaseType_t    uxPriority,  
    TaskHandle_t*  pxCreatedTask,  
    const BaseType_t xCoreID)
```

This is a mysterious function that appears to be ESP32 specific.

When a created task is invoked and then decides to end via a return, it is essential that the task call `vTaskDelete(NULL)` before it completes. Calling this is an indication to FreeRTOS that the task is finished and need no longer be considered for context switching. Experience seems to show that if we don't do this then the ESP32 will crash. In summary, end your return logic in your task functions with:

```
{  
    // Previous code here.  
    vTaskDelete(NULL);  
    return;  
}
```



In an ESP32 environment, an example, we might have:

```
void myTask(void *parms) {
    // Do something
    vTaskDelete(NULL);
}

main() {
    xTaskCreatePinnedToCore(&myTask, "myTask", 2048, NULL, 5, NULL, 0);
}
```

The `xCoreID` specifies which core to run on. Choices are 0 (PRO CPU) or 1 (APP CPU) to `"tskNO_AFFINITY"`.

Include:

- `#include <freertos/FreeRTOS.h>`
- `#include <freertos/task.h>`

See also:

- `vTaskDelete`

### **vTaskDelay**

Delay a task for a specified number of ticks.

```
void vTaskDelay(const TickType_t xTicksToDelay)
```

The constant called `portTICK_PERIOD_MS` provides the number of ticks in a millisecond.

If we wished to delay for 1 second, we could then supply `1000 / portTICK_PERIOD_MS`.

Example:

Sleep for 5 seconds:

```
vTaskDelay(5*1000/portTICK_PERIOD_MS);
```

Include:

- `#include <freertos/FreeRTOS.h>`
- `#include <freertos/task.h>`

See also:

- [vTaskDelay](#)
- Timers in FreeRTOS

### **vTaskDelayUntil**

Delay a task until a specified absolute time.

```
void vTaskDelayUntil(  
    const TickType_t* pxPreviousWakeTime,  
    const TickType_t xTimeIncrement)
```

**Note:** This is flagged as an un-tested FreeRTOS function.

This function blocks a task until some absolute time in the future.

- `pxPreviousWakeTime` – The base time which the increment will be relative from.
- `xTimeIncrement` – The time in ticks which, when added to the `pxPreviousWakeTime`, will be the time that the task is ready to run again.

Include:

- `#include <freertos/FreeRTOS.h>`
- `#include <freertos/task.h>`

See also:

- [vTaskDelayUntil](#)
- Timers in FreeRTOS

## vTaskDelete

Delete an instance of a task.

```
void vTaskDelete(TaskHandle_t pxTask)
```

This function will delete an instance of a task. If the `pxTask` handle is `NULL` then the current task will be deleted. A task should commonly call this to delete itself when finished.

Include:

- `#include <freertos/FreeRTOS.h>`
- `#include <freertos/task.h>`

See also:

- `xTaskCreate`
- `xTaskCreatePinnedToCore`
- [vTaskDelete](#)

## taskDISABLE\_INTERRUPTS

```
taskDISABLE_INTERRUPTS()
```

This is a macro that disables interrupts.

Include:

- `#include <freertos/FreeRTOS.h>`

- `#include <freertos/task.h>`

See also:

- `taskENABLE_INTERRUPTS`

### `taskENABLE_INTERRUPTS`

#### `taskENABLE_INTERRUPTS()`

This is a macro that enables interrupts.

Include:

- `#include <freertos/FreeRTOS.h>`
- `#include <freertos/task.h>`

See also:

- `taskDISABLE_INTERRUPTS`

### `vTaskGetInfo`

```
void vTaskGetInfo(
    TaskHandle_t xTask,
    TaskStatus_t* pxTaskStatus,
    BaseType_t xGetFreeStackSpace,
    eTaskState eState)
```

The calculation of the current state that is returned can be time consuming, to calculate its value, pass in `eState` with a value of `eInvalid`.

The calculation of the minimum amount of free stack space we have seen is also expensive so pass in a value of `pdTRUE` to retrieve it and `pdFALSE` to ignore it.

The `TaskStatus_t` contains:

- `TaskHandle_t xHandle` –
- `const signed char* pcTaskname` –
- `UBaseType_t xTaskNumber` –
- `eTaskState eCurrentState` –
- `UBaseType_t uxCurrentPriority` –
- `UBaseType_t uxBasePriority` –
- `unsigned long ulRunTimeCounter` –
- `StackType_t* pxStackBase` –

- unsigned short usStackHighWaterMark –

### **xTaskGetCurrentTaskHandle**

Get the current task handle.

```
TaskHandle_t xTaskGetCurrentTaskHandle()
```

Can be called withing the context of a task to return our own task handle.

Includes:

- `#include <freertos/task.h>`

See also:

- `esp_task_wdt_add`

### **pcTaskGetTaskName**

Get the name of the task.

```
char *pcTaskGetTaskName(TaskHandle_t xTaskToQuery)
```

If we supply NULL for the task handle, we get our own task name.

Includes:

- `#include <freertos/FreeRTOS.h>`
- `#include <freertos/task.h>`

### **uxTaskGetNumberOfTasks**

Get the number of tasks.

```
UBaseType_t uxTaskGetNumberOfTasks()
```

Once we know the number of tasks, we can retrieve the details of them through a call to `uxTaskGetSystemState()`.

Includes:

- `#include <freertos/FreeRTOS.h>`
- `#include <freertos/task.h>`

See also:

- `uxTaskGetSystemState`

## uxTaskGetSnapshotAll

```
UBaseType_t uxTaskGetSnapshotAll(  
    TaskSnapshot_t* const pxTaskSnapshotArray,  
    const UBaseType_t uxArraySize,  
    UBaseType_t* const pxTcbSz)
```

### Includes:

- #include <freertos/FreeRTOS.h>
- #include <freertos/task.h>

## uxTaskGetStackHighWaterMark

```
UBaseType_t uxTaskGetStackHighWaterMark(TaskHandle_t xTask)
```

### Includes:

- #include <freertos/FreeRTOS.h>
- #include <freertos/task.h>

## pxTaskGetStackStart

```
uint8_t* pxTaskGetStackStart(TaskHandle_t xTask)
```

### Includes:

- #include <freertos/FreeRTOS.h>
- #include <freertos/task.h>

## eTaskGetState

Retrieve the state of a task.

```
eTaskState eTaskGetState(TaskHandle_t xTask)
```

The possible values are:

- eReady –
- eRunning –
- eBlocked –
- eSuspended –
- eDeleted –

Includes:

- `#include <freertos/FreeRTOS.h>`
- `#include <freertos/task.h>`

### **uxTaskGetSystemState**

**Note:** This is disabled by default. To enable the `configUSE_TRACE_FACILITY` definition in `FreeRTOSConfig.h` must be set to 1. When enabled, we still get an assert as this is flagged as an "untested" function.

Retrieve the task state for all tasks in the environment.

```
UBaseType_t uxTaskGetSystemState(  
    TaskStatus_t*      pxTaskStatusArray,  
    const UBaseType_t uxArraySize,  
    uint32_t*          pulTotalRunTime)
```

The `TaskStatus_t` contains:

- `TaskHandle_t xHandle` –
- `const signed char* pcTaskname` –
- `UBaseType_t xTaskNumber` –
- `eTaskState eCurrentState` –
- `UBaseType_t uxCurrentPriority` –
- `UBaseType_t uxBasePriority` –
- `unsigned long ulRunTimeCounter` –
- `StackType_t* pxStackBase` –
- `unsigned short usStackHighWaterMark` –

The return type is the number of tasks populated. We can call `uxTaskGetNumberOfTasks()` to determine how many tasks are present.

The `pulTotalRunTime` is set to the total run time since booted. We can pass NULL if we don't need the value.

Includes:

- `#include <freertos/FreeRTOS.h>`
- `#include <freertos/task.h>`

See also:

- `uxTaskGetNumberOfTasks`

- `vTaskGetInfo`

### **xTaskGetTickCount**

Get the current tick count.

```
TickType_t xTaskGetTickCount()
```

Return the number of ticks that have occurred since the task scheduler was started.

The macro called `portTICK_PERIOD_MS` defines the duration of a single tick in milliseconds.

Include:

- `#include <freertos/task.h>`

See also:

- [Timers in FreeRTOS](#)

### **xTaskGetTickCountFromISR**

Get the current tick count from an Interrupt Service Routine.

```
TickType_t xTaskGetTickCountFromISR()
```

Include:

- `#include <freertos/task.h>`

### **vTaskList**

```
void vTaskList(char* pcWriteBuffer)
```

**NOT AVAILABLE**

### **uxTaskPriorityGet**

Get the priority of the task.

```
UbaseType_t uxTaskPriorityGet(TaskHandle_t xTask)
```

Include:

- `#include <freertos/task.h>`

See also:

- [Priorities and FreeRTOS tasks](#)

- `vTaskPrioritySet`

### **uxTaskPriorityGetFromISR**

Get the priority of the task.

```
UbaseType_t uxTaskPriorityGet(TaskHandle_t xTask)
```

Include:

- `#include <freertos/task.h>`

See also:

- Priorities and FreeRTOS tasks

### **vTaskPrioritySet**

Set the priority for the given task.

```
void vTaskPrioritySet(TaskHandle_t pxTask, UbaseType_t uxNewPriority)
```

The handle for the task to have its priority changed can be supplied as `NULL` which will mean the current task.

Include:

- `#include <freertos/task.h>`

See also:

- Priorities and FreeRTOS tasks
- `uxTaskPriorityGet`

### **vTaskResume**

Resume a task that was previously suspended.

```
void vTaskResume(TaskHandle_t pxTaskToResume)
```

Include:

- `#include <freertos/task.h>`

See also:

- `vTaskSuspend`

### **vTaskResumeFormISR**

Resume a task that was previously suspended.

```
void vTaskResume(TaskHandle_t pxTaskToResume)
```



Include:

- `#include <freertos/task.h>`

### **xTaskResumeAll**

`BaseType_t xTaskResumeAll ()`

Include:

- `#include <freertos/task.h>`

See also:

- [vTaskResumeAll](#)

### **vTaskResumeFromISR**

`void xTaskResumeFromISR (TaskHandle_t pxTaskToResume)`

Include:

- `#include <freertos/task.h>`

### **vTaskSuspend**

Suspend the given task.

`void vTaskSuspend (TaskHandle_t pxTaskToSuspend)`

The identified task is suspended until it is allowed to continue.

Include:

- `#include <freertos/task.h>`

See also:

- `vTaskResume`
- `xTaskResumeAll`

### **vTaskSuspendAll**

`void vTaskSuspendAll ()`

Include:

- `#include <freertos/task.h>`

See also:

- [vTaskSuspendAll](#)

## xTimerChangePeriod

Change the period of an existing timer.

```
BaseType_t xTimerChangePeriod(  
    TimerHandle_t xTimer,  
    TickType_t    xNewPeriod,  
    TickType_t    xBlockTime)
```

When a timer is created through a call to `xTimerCreate()`, we can subsequently change the period of that timer.

- `xTimer` – The handle to the existing timer.
- `xNewPeriod` – The new period value for the timer.
- `xBlockTime` – The duration that this function can maximally wait for processing.

Includes:

- `#include <freertos/timers.h>`

## xTimerChangePeriodFromISR

Change the period of an existing timer from within an Interrupt Service Routine.

```
BaseType_t xTimerChangePeriodFromISR(  
    TimerHandle_t xTimer,  
    TickType_t    xNewPeriod,  
    BaseType_t*   pxHigherPriorityTaskWoken)
```

- `xTimer` – The handle to the existing timer.
- `xNewPeriod` – The new period value for the timer.
- `pxHigherPriorityTaskWoken` – Flag indicating that a context switch should occur.

Includes:

- `#include <freertos/timers.h>`

## xTimerCreate

Create a new timer.

```
TimerHandle_t xTimerCreate(  
    const char*          pcTimerName,  
    const TickType_t     xTimerPeriod,  
    const UBaseType_t    uxAutoReload,
```

```
void*                pvTimerID,  
TimerCallbackFunction_t pxCallbackFunction)
```

- `pcTimerName` – The name of the timer used for debugging and reporting.
- `xTimerPeriod` – The period, measured in ticks, after which the timer should fire.
- `uxAutoReload` – A flag which indicates whether or not the timer should restart once fired. If restarted, it will start again using the `xTimerPeriod` value for the next interval.
- `pvTimerID` – Data available to the timer callback function when fired.
- `pxCallbackFunction` – Function called when the timer expires. The signature of this function is:

```
void vCallbackFunction(TimerHandle_t xTimer)
```

The return from the `xTimerCreate` function is a handle that can be used to refer to this timer in the future.

Includes:

- `#include <freertos/timers.h>`

### **xTimerCreateStatic**

```
TimerHandle_t xTimerCreateStatic(  
    const char*          pcTimerName,  
    const TickType_t     xTimerPeriod,  
    const UBaseType_t    uxAutoReload,  
    void*                pvTimerID,  
    TimerCallbackFunction_t pxCallbackFunction  
    StaticTimer_t*       pxTimerBuffer)
```

Includes:

- `#include <freertos/timers.h>`

### **xTimerDelete**

Delete an existing timer.

```
BaseType_t xTimerDelete(TimerHandle_t xTimer, TickType_t xBlockTime)
```

This call deletes a timer that was previous created by an `xTimerCreate()` call. Following a successful call, we should not attempt to refer to this timer again.

- `xTimer` – The handle to the timer to delete.

- `xBlockTime` – The length of timer we should block waiting for the delete to be processed.

Includes:

- `#include <freertos/timers.h>`

### **pcTimerGetName**

Get the name of the timer.

```
const char* pcTimerGetName(TimerHandle_t xTimer)
```

When we created a timer using `xTimerCreate()` we supplied a name identity for the timer. This call returns that value.

- `xTimer` – The handle to a previously created timer.

Includes:

- `#include <freertos/timers.h>`

### **xTimerGetExpiryTime**

**Note: Not implemented in ESP-IDF.**

Return the time at which the timer will fire.

```
TickType_t xTimerGetExpiryTime(TimerHandle_t xTimer)
```

For an active timer, this call will return the tick value at which the timer will fire. This is an absolute value. If we want to know how many ticks in the future this will be, we can obtain the current tick value and subtract one from the other.

- `xTimer` – The handle to a previously created timer.

Includes:

- `#include <freertos/timers.h>`

See also:

- `xTaskGetTickCount`

### **xTimerGetPeriod**

**Note: Not implemented in ESP-IDF.**

Get the period value for a timer.

```
TickType_t xTimerGetPeriod(TimerHandle_t xTimer)
```

Return the period value for the timer. This is the value passed in when `xCreateTimer()` was initially created. It is a relative value rather than an absolute expiry time. If the timer is configured to restart, this is the value that will be used to fire the next instance of the timer.

- `xTimer` – The handle to a previously created timer.

Includes:

- `#include <freertos/timers.h>`

### **pvTimerGetTimerDaemonTaskHandle**

Retrieve the task handle to the timer daemon.

```
TaskHandle_t xTimerGetTimerDaemonTaskHandle(void)
```

Behind the scenes, FreeRTOS is running a task that is managing the timers. There may be times when we want to get access to the handle for this task. This API returns the handle.

Includes:

- `#include <freertos/timers.h>`

### **pvTimerGetTimerID**

Retrieve the data associated with an instance of the timer.

```
void *pvTimerGetTimerID(TimerHandle_t xTimer)
```

When a timer is created, we can associate data with it. We can also update that data at a later timer. This API retrieves the current value of the data.

- `xTimer` – The handle to a previously created timer.

Includes:

- `#include <freertos/timers.h>`

### **xTimerIsTimerActive**

Determine if the timer is active.

```
 BaseType_t xTimerIsTimerActive(TimerHandle_t xTimer)
```

An active timer is one that is ticking down to a time when it will fire.

- `xTimer` – The handle to a previously created timer.

Includes:

- `#include <freertos/timers.h>`

### **xTimerPendFunctionCall**

Execute a function on the timer daemon task.

```
BaseType_t xTimerPendFunctionCall(
    PendedFunction_t xFunctionToPend,
    void*            pvParameter1,
    uint32_t         ulParameter2,
    TickType_t       xTicksToWait)
```

Calling this API causes the function supplied to execute on the timer daemon task.

- `xFunctionToPend` – The function to be executed in the context of the timer daemon task. The function has the following signature:

```
void vPendableFunction(void *pvParameter1, uint32_t ulParameter2)
```

- `pvParameter1` – A parameter to be passed to the function.
- `ulParameter2` – A parameter to be passed to the function.
- `xTicksToWait` – A duration to wait for the function to be started.

Includes:

- `#include <freertos/timers.h>`

### **xTimerPendFunctionCallFromISR**

```
BaseType_t xTimerPendFunctionCallFromISR(
    PendedFunction_t xFunctionToPend,
    void*            pvParameter1,
    uint32_t         ulParameter2,
    BaseType_t*      pxHigherPriorityTaskWoken)
```

Includes:

- `#include <freertos/timers.h>`

### **xTimerReset**

Reset the value of the timer.

```
BaseType_t xTimerReset(TimerHandle_t xTimer, TickType_t xBlockTime)
```

Reset the value of the timer to start ticking from the time when this API was called with the period associated with the timer.

- `xTimer` – The handle to a previously created timer.
- `xBlockTime` – The time to wait for the reset to complete.

Includes:

- `#include <freertos/timers.h>`

### **xTimerResetFromISR**

```
 BaseType_t xTimerResetFromISR(
     TimerHandle_t xTimer,
     BaseType_t* pxHigherPriorityTaskWoken)
```

### **vTimerSetTimerID**

**Note: Not implemented in ESP-IDF.**

Associate data with the timer.

```
void vTimerSetTimerID(TimerHandle_t xTimer, void *pvNewID)
```

- `xTimer` – The handle to a previously created timer.
- `pvNewID` – Reference to data to be associated with the timer.

Includes:

- `#include <freertos/timers.h>`

### **xTimerStart**

Start a timer ticking.

```
BaseType_t xTimerStart(TimerHandle_t xTimer, TickType_t xBlockTime)
```

The timer can be stopped before expiration with a call to `xTimerStop()`.

- `xTimer` – The handle to a previously created timer.
- `xBlockTime` – The time to wait for the start request to complete.

Includes:

- `#include <freertos/timers.h>`

## xTimerStartFromISR

```
 BaseType_t xTimerStartFromISR(  
     TimerHandle_t xTimer,  
     BaseType_t *pxHigherPriorityTaskWoken)
```

Includes:

- `#include <freertos/timers.h>`

## xTimerStop

Stop a timer ticking.

```
 BaseType_t xTimerStop(TimerHandle_t xTimer, TickType_t xBlockTime)
```

- `xTimer` – The handle to a previously created timer.
- `xBlockTime` – The time to wait for the stop request to complete.

Includes:

- `#include <freertos/timers.h>`

## xTimerStopFromISR

```
 BaseType_t xTimerStopFromISR(  
     TimerHandle_t xTimer,  
     BaseType_t *pxHigherPriorityTaskWoken)
```

Includes:

- `#include <freertos/timers.h>`

## List Processing

### vListInitialise

Initialize a list.

```
void vListInitialise(xList * const pxList)
```

The `pxList` is a list that should be initialized.

### vListInitialiseItem

Initialize an item for insertion into a list.

```
void vListInitialiseItem(xListItem * const pxItem)
```

Initialize an item that can be added to a list.



### vListInsert

Insert an item into a list.

```
void vListInsert(xList * const pxList, xListItem * const pxNewListItem)
```

### vListInsertEnd

Insert an item at the end of a list

```
void vListInsertEnd( xList * const pxList, xListItem * const pxNewListItem)
```

## Sockets APIs

For the TCP/IP protocol, the programming API originally developed for the Unix platform and written in C was called "sockets". The notion of a socket is that it logically represents an endpoint of a network connection. A sender of data sends data through the socket and the receiver of data receives data through the socket. The implementation of the "socket" itself is provided by the libraries but the logical notion of the socket remains. You will find yourself working with an "instance" of a socket and you should think of it as an opaque data type that refers to a communication link.

Sockets remains the primary API and is present in the majority of languages. Here we discuss some of the variants for some of the more common languages.

See also:

- [TCP/IP Sockets](#)

### **accept**

Accept an incoming request.

```
int accept(int socket_fd, struct sockaddr* addr, socklen_t* addrlen)
```

Here we can block waiting for an incoming connection request from the server socket. We will return immediately if there is a client connection awaiting acceptance. The address of the client is returned to us along with its length.

If we try and accept too many concurrent sockets, the ESP32 may return `ENFILE` to indicate that we have an overflow.

The return is the accepted socket connection to the client or -1 if an error. The `addr` structure is filled in with the *remote* address information of the partner.

See also:

- [TCP/IP Sockets](#)
- [man\(2\) – accept](#)

## bind

Associate a socket with an address.

```
int bind(int s, const struct sockaddr* name, socklen_t namelen)
```

The `name` parameter is the socket address to be bound to the socket. The `namelen` provides the length of the address. If the `sin_addr.s_addr` is `htonl(INADDR_ANY)` then we are being a server listening on any incoming IP address.

A return of `< 0` on error.

Here is an example of us defining ourselves as a server:

```
struct sockaddr_in serverAddr;
serverAddr.sin_family      = AF_INET;
serverAddr.sin_addr.s_addr = htonl(INADDR_ANY);
serverAddr.sin_port       = htons(80);

int rc = bind(serverSocket, (struct sockaddr*)&serverAddr, sizeof(serverAddr));
```

If we have bound a socket to a local port and then close that bound socket, the port number remains reserved for a period of time to "cleanup" any in-flight traffic. This prevents the socket from being re-used and a `bind()` attempt can result in an "address already in use" error. We can request that the `bind()` succeed even if the port is in this timed wait state. We do this by running:

```
setsockopt(s, SOL_SOCKET, SO_REUSEADDR, &(int){ 1 }, sizeof(int));
```

which sets the sockets level "SO\_REUSEADDR" flag.

See also:

- [TCP/IP Sockets](#)
- [man\(2\) – bind](#)

## close

Close the corresponding socket.

```
int close(int s)
```

Close the socket. After closing a socket, no further sockets APIs should be called against it. This is the last call in the chain. Take care to realize that when a socket is

created with the `socket()` API the return is a socket handle that is also known as a file descriptor. A socket handle is unique **only** for the lifetime of the socket. For example, if you call `socket()`, you might get back a handle that has a value of 3. While that socket is alive, no other caller of `socket()` will be issued the same handle. However, once you close the `socket()`, it is entirely possible that the next caller of `socket()` will itself be issued the value of 3 because, at that time, the socket handle is unused. The reason for spending time on this is that if you are saving socket handles it is not difficult to close a handle and then forget that you have closed it and later make a sockets API call against the value of the handle when in fact it has been assigned to a different socket in the intervening time period. No technical errors will be thrown as at the time you are making a socket API call, it is indeed a valid socket handle you are using ... it just happens to not be the one your were expecting to use.

See also:

- [man\(2\) – close](#)
- `socket`

## **closesocket**

Close the corresponding socket.

```
closesocket(int s)
```

Close the socket.

## **connect**

Connect to a server.

```
int connect(int sockFd, const struct sockaddr* partnerAddr, socklen_t addrlen)
```

Connect the socket to a partner. The address of the partner is supplied in the `partnerAddr` field. This is a client initiated call and is expected to connect with a listening server.

For example:

```
struct sockaddr_in serverAddress;  
serverAddress.sin_family = AF_INET;  
inet_pton(AF_INET, "192.168.1.200", &serverAddress.sin_addr.s_addr);  
serverAddress.sin_port = htons(9999);
```

```
int rc = connect(sock, (struct sockaddr *)&serverAddress, sizeof(struct sockaddr_in));
```

Includes:

- `#include <lwip/sockets.h>`

See also:

- [man\(2\) – connect](#)

## fcntl

Perform control functions.

```
fcntl(int s, int cmd, int val)
```

We can set control functions on sockets here.

Command	Value	Description
F_SETFL	O_NONBLOCK	Set the socket non blocking.

See also:

- [man\(2\) – fcntl](#)

## freeaddrinfo

Release storage allocated by `getaddrinfo()`.

```
void freeaddrinfo(struct addrinfo* res)
```

Includes:

- `#include <lwip/netdb.h>`

See also:

- `getaddrinfo`

## getaddrinfo

Build an address structure for a desired target.

```
int getaddrinfo(  
    const char*      node,  
    const char*      service,  
    const struct addrinfo* hints,  
    struct addrinfo** res)
```

The `node` parameter is the host-name of the target server. The `service` is the name of a service used to look-up the target port number. It isn't clear how that would work on an ESP32. Where would the service to port mappings be kept?

The `hints` provides a filter for what to return. It can be `NULL`. If it is supplied, it is a pointer to a `struct addrinfo` with the following fields filled in:

The `ai_family` can be one of:

- `AF_INET`
- `AF_INET6`
- `AF_UNSPEC`

The `ai_socktype` can be one of:

- `SOCK_STREAM`
- `SOCK_DGRAM`

The `addrinfo` structure is defined as follows:

```
struct addrinfo {
    int          ai_flags;
    int          ai_family;
    int          ai_socktype;
    int          ai_protocol;
    socklen_t    ai_addrlen;
    struct sockaddr* ai_addr;
    char*        ai_canonname;
    struct addrinfo* ai_next;
};
```

A return code of 0 indicates success otherwise it returns an error code. Note that `errno` is not used as that is not thread safe.

The `res` pointer points to an allocated `struct addrinfo` storage area that must be subsequently released with a call to `freeaddrinfo()`.

The `struct sockaddr` is common cast to a `struct sockaddr_in` which is defined as:

```
struct sockaddr_in {
    short        sin_family;
    unsigned short sin_port;
    struct in_addr sin_addr;
    char         sin_zero[8];
};

struct in_addr {
    unsigned long s_addr;
};
```

What this means is that the IP address can be found at `var.sin_addr` or `var.sin_addr.s_addr`.

Includes:

- `#include <lwip/netdb.h>`

See also:

- `freeaddrinfo`
- `gethostbyname`
- `gethostbyname_r`
- [man\(3\) – getaddrinfo](#)

## gethostbyname

Look-up a host name through name resolution.

```
struct hostent *gethostbyname(const char *name)
```

Most likely a wrapper around the lwip `dns_gethostbyname()` implementation provided by the underlying lwip implementation.

A pointer to a `struct hostent` is returned. This is a buffer maintained by the network layer and will be changed in the next call. The members of a `struct hostent` are:

Member	Description
<code>char* h_name</code>	The name of the host.
<code>char** h_aliases</code>	An array of alternative names. Last entry is a NULL pointer.
<code>int h_addrtype</code>	The type of addresses. One of <code>AF_INET</code> or <code>AF_INET6</code> .
<code>int h_length</code>	The length of an address in bytes.
<code>char** h_addr_list</code>	An array of network addresses for the host. Last entry is a NULL pointer.

Includes:

- `#include <lwip/netdb.h>`

See also:

- `dns_getserver`
- `dns_setserver`
- `inet_ntop`
- `inet_pton`
- [LWIP Wiki – DNS](#)
- [man\(3\) – gethostbyname](#)

## gethostbyname\_r

A re-entrant version of name resolution.

```
int gethostbyname_r(
    const char*    name,
    struct hostent* ret,
    char*          buf,
    size_t         buflen,
    struct hostent** result,
    int*           h_errnop)
```

See [here](#) for an example of use.

See also:

- [man\(3\) – gethostbyname\\_r](#)

## getpeername

Retrieve the address associated with the partner/peer to which the socket is connected.

```
int getpeername(int s,
                struct sockaddr* peerAddr,
                socklen_t* namelen)
```

Note that `namelen` must be primed with the size of the available address buffer.

See also:

- [man\(2\) – getpeername](#)

## getsockname

Retrieve the current local address to which the socket is bound.

```
getsockname(int s,
            struct sockaddr* name,
            socklen_t* namelen)
```

Note that `namelen` must be primed with the size of the available address buffer.

Example:

```
struct sockaddr_in addrInfo;
unsigned int addrInfoSize = sizeof(addrInfo);
getsockname(mySocket, (struct sockaddr*)&addrInfo, &addrInfoSize);
```

See also:

- [man\(2\) – getsockname](#)

## getsockopt

```
int getsockopt(
    int s,
    int level,
    int optname,
    void* optval,
    socklen_t* optlen)
```

An important example of using this function is to retrieve the last error associated with the socket. The following code fragment illustrates this:

```
int esp_x_last_socket_errno(int socket) {
    int ret = 0;
    u32_t optlen = sizeof(ret);
```

```
    getsockopt(socket, SOL_SOCKET, SO_ERROR, &ret, &optlen);
    return ret;
}
```

See also:

- [man\(2\) - getsockopt](#)

## htonl

Convert a host formatted long integer to network byte order.

```
uint32_t htonl(uint32_t netLong)
```

See also:

- [man\(3\) - htonl](#)

## htons

Convert a host formatted short integer to network byte order.

```
uint16_t htons(uint16_t hostShort)
```

See also:

- [man\(3\) - htons](#)

## inet\_ntop

Convert an IP address structure into a character string.

```
char *inet_ntop(int af, const char* src, char* dst, socklen_t size)
```

The `af` parameter specified the address family. It may have a value of:

- `AF_INET` – IPv4 network addresses.
- `AF_INET6` – IPv6 network addresses.

The `src` is the pointer to the address structure. The `dst` is the buffer that will be filled with the text and `size` is the length of that buffer available to be filled. For `AF_INET`, the buffer should be at least `INET_ADDRSTRLEN` bytes long while for `AF_INET6`, it should be at least `INET6_ADDRSTRLEN` bytes long.

Includes:

- `#include <lwip/sockets.h>`

See also:

- [man\(3\) - inet\\_ntop](#)



## inet\_pton

Convert an IP address from string to binary form.

```
int inet_pton(int af, const char* src, void* dst)
```

The `af` parameter is the address family. It must be one of:

- `AF_INET` – IPv4 network address.
- `AF_INET6` – IPv6 network address.

The `src` is the pointer to a null terminate string that represents the text format of the address.

Returns 1 on success.

Includes:

- `#include <lwip/sockets.h>`

See also:

- [man\(3\)–inet\\_pton](#)

## ioctlsocket

```
ioctl(int s, long cmd, void *argp)
```

## listen

Start listening for incoming connections.

```
int listen(int socket_fd, int backlog)
```

If we are bound as a server, we will start to listen for incoming connections requests on the socket. The `backlog` parameter defines how many sockets we can keep a handle to before we accept them.

A return value `< 0` means an error.

See also:

- TCP/IP Sockets
- [man\(2\)–listen](#)

## read

Receive data from a partner.

```
ssize_t read(int s, void* mem, size_t len)
```

Similar to the `recv()` function.

See also:

- `recv`
- `recvfrom`
- [man\(2\) – read](#)

## **recv**

Receive data from a partner.

```
ssize_t recv(int s,  
             void* mem,  
             size_t len,  
             int flags)
```

This function returns the number of bytes actually received. A value of -1 indicates an error. A value of zero indicates the partner having closed the connection.

The flags is the boolean combination of:

- `MSG_CMSG_CLOEXEC` –
- `MSG_DONTWAIT` – Indicate that we don't want to block waiting for data. If there is no data immediately available for us to receive, we return -1 to indicate an error and the error code is "EAGAIN".
- `MSG_ERRQUEUE` –
- `MSG_OOB` –
- `MSG_PEEK` –
- `MSG_TRUNC` –
- `MSG_WAITALL` –

Includes:

- `#include <lwip/sockets.h>`

See also:

- `read`
- `recvfrom`
- [man\(2\) – recv](#)

## **recvfrom**

Receive a datagram from another machine/device.

```
ssize_t recvfrom(int sock,  
                void* mem,
```

```

size_t len,
int      flags,
struct sockaddr* from,
socklen_t* fromlen)

```

The `sock` is a socket handle that was previously opened by calling `socket()`. The `mem` is a pointer to a buffer that will hold the incoming data. The `len` parameter supplies the length of the buffer. The `from` is a pointer to a storage area that will hold the address of the partner and `fromLen` will be the length of that address. On initial call, it should contain the length of the `from` address. If we don't need the return address of the caller, we can supply NULL for both `from` and `fromlen`.

The flags can be specified as:

- `MSG_DONTWAIT` – Don't block waiting for a message not yet arrived.
- `MSG_OOB` – Check for an out of band message.
- `MSG_PEEK` – Receive the first message without consuming it.

The return value is the number of bytes actually received or -1 on an error.

Includes

- `#include <sys/types.h>`

See also:

- `read`
- `recv`
- `socket`
- `sendto`
- [man\(2\) – recvfrom](#)

## select

Check for data available for reading or writing.

```

int select(
    int      maxfdp1,
    fd_set*  readset,
    fd_set*  writeset,
    fd_set*  exceptset,
    struct timeval* timeout)

```

The notion of "ready" is that an operation could be performed without blocking.

The `maxfdp1` is the maximum value of the file descriptor plus 1.

On some Linux systems, to use `select`, one would include `<sys/select.h>`. In ESP-IDF that is not present but does not appear to be needed.

Each of the `fd_set` variables defines a set of file descriptors. To include a file descriptor in a set we can run `FD_SET(fd, &set)`. To remove an entry we can call `FD_CLR(fd, &set)`. To test if a file descriptor is in a set we can run `FD_ISSET(fd, *set)` and to clear a complete set we can run `FD_ZERO(&set)`. If we aren't interested in some of the sets, we can supply `NULL` to have them ignored.

If `timeout` is `NULL`, then there will be no timeout and `select` will wait indefinitely. If both fields in the `timeval` are 0, then we return immediately.

On return, `select()` returns the number of bits set in the various sets (which may be 0 if there was a timeout). An error of -1 is returned on an error.

A socket that is a server socket is considered "ready" if a call to `accept()` would not block. This socket should be supplied in the `readset`.

Take care with the first parameter. This is the number of file descriptor bits to check in the file descriptor mask set. If the highest file descriptor value we have is "n" then the number of file descriptor bits we are examining is "n+1".

See also:

- Using `select()`
- [man\(2\) – select](#)

## send

Send a set of bytes down the socket to the partner.

```
ssize_t send(int s, const void* dataptr, size_t size, int flags)
```

The data pointed to by `dataptr` for `size` bytes is transmitted.

See also:

- [man\(2\) – send](#)

## sendmsg

```
ssize_t sendmsg(int s, const struct msghdr* msg, int flags)
```

See also:

- [man\(2\) – sendmsg](#)

## sendto

Send data to a UDP partner.

```
ssize_t sendto(int sock,
               const void* dataptr,
               size_t size,
```

```
int          flags,  
const struct sockaddr* to,  
socklen_t   tolen)
```

The `sock` is the socket handle that was previously opened by a call to `socket()`. The `dataptr` is a pointer to a buffer of data that we wish to send. The `size` is the size of the datagram that we wish to send. It can be a maximum of 64K. The `to` is the address of the destination of the message and `tolen` is the length of the address structure.

The flags can be one or more of:

- `MSG_DONTWAIT` – Do not wait if waiting would be needed.
- `MSG_OOB` – Send a message out of band.

The return is the number of bytes actually sent or -1 on an error.

See also:

- `recvfrom`
- `socket`
- [man\(2\) – sendto](#)

## setsockopt

```
int setsockopt(  
int          s,  
int          level,  
int          optname,  
const void*  optval,  
socklen_t   optlen)
```

The options that are anticipated to be available are:

- `TCP_NODELAY` – Disable the Nagle algorithm.
- `SO_KEEPALIVE` – Enable liveness pinging.
- `SO_RCVTIMEO` – Specify a timeout on a `recv()` call.

See also:

- [man\(2\) – setsockopt](#)

## shutdown

Shutdown parts of a socket.

```
int shutdown(int s, int how)
```

Shutdown all or part of the socket.

The socket is shutdown based on the how parameter which may be one of:

- `SHUT_RD` – No further receives are allowed.
- `SHUT_WR` – No further writes are allowed.
- `SHUT_RDWR` – No further reads or writes are allowed.

See also:

- [man\(2\) – shutdown](#)

## socket

Create a new socket for the specific domain, type and protocol.

```
int socket(int domain, int type, int protocol)
```

Domain can be one of:

- `AF_INET` – TCP/IP
- Others ...

Type can be one of:

- `SOCK_STREAM`
- `SOCK_DGRAM`
- `SOCK_RAW`

Protocol can be one of:

- `IPPROTO_IP`
- `IPPROTO_TCP`
- `IPPROTO_UDP`

A common usage pattern is:

```
int sock = socket(AF_INET, SOCK_STREAM, IPPROTO_TCP)
```

Returns a new socket descriptor or a value `< 0` on error.

Includes:

- `#include <lwip/sockets.h>`

See also:

- TCP/IP Sockets
- [man\(2\) – socket](#)

## write

```
ssize_t write(int s, const void* dataptr, size_t size)
```

See also:

- [man\(2\) – write](#)

## writev

See also:

- [man\(2\) – writev](#)

## Socket data structures

[Sockets - struct sockaddr](#)

[Sockets - struct sockaddr\\_in](#)

- `sin_family` – `AF_INET`
- `sin_port`
- `struct in_addr sin_addr` – This structure has a member called `s_addr` which is an IP address. Special values have special meanings. For example `INADDR_ANY` is any address.

## Working with WiFi

In the ESP32 environment, we include the header `<esp_wifi.h>` which provides the signatures for the WiFi functions we will be using. Prior to working with any WiFi components, we want to call `esp_wifi_init()`. This function initializes the WiFi subsystem. Internally it will allocate resources. We have a partner function called `esp_wifi_deinit()` which will destroy our WiFi environment and release the resources. We should not call any other WiFi functions prior to `esp_wifi_init()` and call no further WiFi functions following an `esp_wifi_deinit()`. There is a mandatory parameter to the `esp_wifi_init()` which is a pointer to an instance of `wifi_init_config_t`. We can supply a useful default to this call using the `WIFI_INIT_CONFIG_DEFAULT` macro.

```
wifi_init_config_t config = WIFI_INIT_CONFIG_DEFAULT();  
err = esp_wifi_init(&config);
```

Since an ESP32 can be simultaneously both a station and an access point, that means it has two interfaces. Two interfaces means two distinct mac addresses. We can set or get the values for these 6 byte mac addresses using `esp_wifi_set_mac()` and `esp_wifi_get_mac()`. The first parameter of these calls defines which interface we wish to interact. The value can either be `WIFI_IF_STA` for the station interface or `WIFI_IF_AP` for the access point interface.

If we are acting as an access point, we can ask what stations are connected to us with a call to `esp_wifi_get_station_list()`. This returns us a list of stations that is based on the ESP32 queuing structure.

Once we have performed an access point scan, the ESP32 has a notion of the access points out there. We can then ask for a copy of this information. We need to understand that each access point is identified by a record of type `wifi_ap_record_t` which is composed of:

```
uint8_t bssid[6]
uint8_t ssid[32]
uint8_t primary
wifi_second_chan_t second
int8_t rssi
wifi_auth_mode_t authmode
```

When we call `esp_wifi_get_station_list()` we pass in a pointer to storage which will be populated by these records. We also pass in the maximum number of records we will accept. On return, we are told how many records were populated. We are managing the storage for these records and ESP32 neither allocates nor releases this data.

For example:

```
wifi_ap_record_t apList[10];
uint16_t count = 10;
esp_wifi_get_station_list(&count, apList);
printf("Number of stations populated = %d\n", count);
```

## DNS

The DNS component of ESP32 is provided by the underlying LWIP implementation.

See also:

- [lwip - DNS - Doxygen](#)



## dns\_getserver

Retrieve one of the defined DNS servers.

```
const ip_addr_t dns_getserver(u8_t numdns)
```

- `numdns` – The index of the defined DNS server. ESP32 defined 0 and 1.

The `ip_addr_t` contains a field called `ip4` which is an `ip4_addr_t` which itself contains a field called `addr` which is a `uint32_t`.

Includes:

- `#include <lwip/dns.h>`

See also:

- `gethostbyname`
- [lwip – DNS – Doxygen](#)

## dns\_setserver

Set one of the defined DNS servers.

```
void dns_setserver(u8_t numdns, const ip_addr_t *dnsserver)
```

- `numdns` – The index of the defined DNS server. ESP32 defines 0 and 1.

Here is an example of usage:

```
ip_addr_t dnsserver;
inet_pton(AF_INET, "8.8.8.8", &dnsserver);
dns_setserver(0, &dnsserver);
inet_pton(AF_INET, "8.8.4.4", &dnsserver);
dns_setserver(1, &dnsserver);
```

Includes:

- `#include <lwip/dns.h>`

See also:

- `gethostbyname`
- `tcpip_adapter_set_dns_info`
- `tcpip_adapter_get_dns_info`
- `dns_setserver`
- [lwip – DNS – Doxygen](#)

## System Functions

### esp\_chip\_info

Retrieve information about this instance of the ESP32.

```
void esp_chip_info(esp_chip_info_t* outInfo)
```

The `outInfo` is a structure which contains:

- `esp_chip_model_t model` – Which model of chip are we?
  - `CHIP_ESP32` – We are an ESP32.
- `uint32_t features` – A bit mask describing a set of features:
  - `CHIP_FEATURE_EMB_FLASH` – Do we have embedded flash?
  - `CHIP_FEATURE_WIFI_BGN` – Do we have Wifi?
  - `CHIP_FEATURE_BLE` – Do we have BLE?
  - `CHIP_FEATURE_BT` – Do we have bluetooth?
- `uint8_t cores` – The number of cores present on the device.
- `uint8_t revision` – The revision of the device.

Includes:

- `#include <esp_system.h>`

### `esp_cpu_in_ocd_debug_mode`

Determine if a JTAG debugger is attached to CPU.

```
bool esp_cpu_in_ocd_debug_mode()
```

### `esp_deregister_freertos_idle_hook`

```
void esp_deregister_freertos_idle_hook(esp_freertos_idle_cb_t old_idle_cb)
```

Includes:

- `#include <esp_freertos_hooks.h>`

### `esp_deregister_freertos_tick_hook`

```
void esp_deregister_freertos_tick_hook(esp_freertos_tick_cb_t old_tick_cb)
```

Includes:

- `#include <esp_freertos_hooks.h>`

### `esp_efuse_read_mac`

```
esp_err_t system_efuse_read_mac(uint8_t mac[6])
```

### **esp\_get\_free\_heap\_size**

Get the size of the available memory heap.

```
uint32_t esp_get_free_heap_size()
```

For example 40544.

As a test I wrote an app that logged the free heap size after boot. This is as of 2016-10-05. The result was 195568.

This is implemented by a call to `heap_caps_get_free_size()`.

Includes:

- `#include <esp_system.h>`

See also:

- RAM Utilization
- `heap_caps_get_free_size`

### **esp\_get\_idf\_version**

Return a representation of the ESP-IDF version against which the application was compiled.

```
const char *esp_get_idf_version()
```

An example of the return might be:

```
v2.0-rc1-930-g058eb26
```

Includes:

- `#include <esp_system.h>`

### **esp\_ipc\_call**

Invoke a function on a specific CPU.

```
esp_err_t esp_ipc_call(uint32_t cpu_id, esp_ipc_func_t func, void* arg)
```

- `cpu_id` – The CPU on which to invoke the function.
- `func` – The function to be invoked.
- `arg` – An argument to the function.

The function signature must be:

```
void func(void* arg)
```

### **esp\_ipc\_call\_blocking**

Invoke a function on a specific CPU and wait for completion.

```
esp_err_t esp_ipc_call(uint32_t cpu_id, esp_ipc_func_t func, void* arg)
```

- `cpu_id` – The CPU on which to invoke the function.
- `func` – The function to be invoked.
- `arg` – An argument to the function.

The function signature must be:

```
void func(void* arg)
```

### **esp\_random**

Get a hardware based random number.

```
uint32_t esp_random()
```

Includes

- `#include <esp_system.h>`

### **esp\_register\_freertos\_idle\_hook**

```
esp_err_t esp_register_freertos_idle_hook(esp_freertos_idle_cb_t new_idle_cb)
```

Includes:

- `#include <esp_freertos_hooks.h>`

### **esp\_register\_freertos\_idle\_hook\_for\_cpu**

```
esp_err_t esp_register_freertos_idle_hook_for_cpu(  
    esp_freertos_idle_cb_t new_idle_cb,  
    UBaseType_t cpuid)
```

Includes:

- `#include <esp_freertos_hooks.h>`

### **esp\_register\_freertos\_tick\_hook**

```
esp_err_t esp_register_freertos_tick_hook(esp_freertos_tick_cb_t new_tick_cb)
```

Includes:

- `#include <esp_freertos_hooks.h>`

### **esp\_register\_freertos\_tick\_hook\_for\_cpu**

```
esp_err_t esp_register_freertos_tick_hook_for_cpu(  
    esp_freertos_tick_cb_t new_tick_cb,  
    UBaseType_t cpuid)
```

Includes:

- `#include <esp_freertos_hooks.h>`

### **esp\_restart**

Restart the system.

```
void esp_restart()
```

Includes

- `#include <esp_system.h>`

### **esp\_sleep\_get\_wakeup\_cause**

```
esp_sleep_wakeup_cause_t esp_sleep_get_wakeup_cause()
```

Returns the reason we "woke up". One of:

- `ESP_SLEEP_WAKEUP_UNDEFINED`
- `ESP_SLEEP_WAKEUP_EXT0`
- `ESP_SLEEP_WAKEUP_EXT1`
- `ESP_SLEEP_WAKEUP_TIMER`
- `ESP_SLEEP_WAKEUP_TOUCHPAD`
- `ESP_SLEEP_WAKEUP_ULP` – Woken by ULP co-processor.

Includes:

- `#include <esp_sleep.h>`
- 

### **ets\_delay\_us**

Delay (by busy waiting) the specified number of microseconds.

```
void ets_delay_us(uint32_t us)
```

Includes:

- `#include <rom/ets_sys.h>`

See also:

- `vTaskDelay`

### **system\_rtc\_mem\_write**

Storage space for saving data during a deep sleep in RTC storage.

Includes:

- `#include <esp_system.h>`

### **rtc\_get\_reset\_reason**

Get the reset reason for a CPU.

```
RESET_REASON rtc_get_reset_reason(int cpuNo)
```

The `RESET_REASON` that is returned may be one of:

- `NO_MEAN` —
- `POWERON_RESET` —
- `SW_RESET` —
- `OWDT_RESET` —
- `DEEPSLEEP_RESET` —
- `SDIO_RESET` —
- `TG0WDT_SYS_RESET` —
- `TG1WDT_SYS_RESET` —
- `RTCWDT_SYS_RESET` —
- `INTRUSION_RESET` —
- `TGWDT_CPU_RESET` —
- `SW_CPU_RESET` —
- `RTCWDT_CPU_RESET` —
- `EXT_CPU_RESET` —
- `RTCWDT_BROWN_OUT_RESET` —
- `RTCWDT_RTC_RESET` —

## software\_reset

```
void software_reset()
```

Includes:

- `#include <rom/rtc.h>`

## software\_reset\_cpu

```
void software_reset_cpu(int cpuNo)
```

The CPU numbers supplied by `cpuNo` are 0 for the PRO CPU and 1 for the APP CPU.

Includes:

- `#include <rom/rtc.h>`

## system\_deep\_sleep

Puts the device to sleep for a period of time.

```
void system_deep_sleep(uint32_t microseconds)
```

The device goes to sleep and when it awakes, it will start at the `user_init` location.

Includes

- `#include <esp_system.h>`

## system\_get\_time

**Note:** `system_get_time()` has been deprecated. Use `gettimeofday()` as a replacement.

Get the system time measured in microseconds since last device start-up.

```
uint32_t system_get_time()
```

This timer will roll over after 71 minutes.

**Note:** Experimentation seems to show that as of 2016-10, the timer does **not** tick until after a call to `esp_wifi_init()`.

Includes:

- `#include <esp_system.h>`

See also:

- Timers and time
- `gettimeofday`

### **system\_restore**

Reset some system settings to defaults.

```
void system_restore()
```

The settings returned to defaults include:

- `wifi_station_set_auto_connect`
- `wifi_set_phy_mode`
- `wifi_softap_set_config`
- `wifi_station_set_config`
- `wifi_set_opmode`

Includes

- `#include <esp_system.h>`

### **system\_rtc\_mem\_read**

Read data from RTC available storage.

Includes:

- `#include <esp_system.h>`

### **system\_rtc\_mem\_write**

Storage space for saving data during a deep sleep in RTC storage.

Includes:

- `#include <esp_system.h>`

### **system\_rtc\_mem\_read**

Read data from RTC available storage.

Includes:

- `#include <esp_system.h>`



## WiFi

The WiFi function provide access to the WiFi capabilities of the device.

See also:

### **esp\_event\_loop\_init**

Initialize the WiFi event loop processing and specify an event handler.

```
esp_err_t esp_event_loop_init(system_event_cb_t cb, void* ctx)
```

Initialize the WiFi event loop processing.

The callback function for the event handler is defined as:

```
esp_err_t (*system_event_cb_t)(void* ctx, system_event_t* event)
```

See also:

- Handling WiFi events
- esp\_event\_loop\_set\_cb

### **esp\_event\_loop\_set\_cb**

Change the event handler used for WiFi events.

```
system_event_cb_t esp_event_loop_set_cb(system_event_cb_t cb, void* ctx)
```

Specify an event handler to be invoked when a WiFi event occurs. The previous event handler is returned.

The callback function for the event handler is defined as:

```
esp_err_t (*system_event_cb_t)(void* ctx, system_event_t* event)
```

If we supply NULL for the callback, then we have removed callback event processing.

Includes:

- `#include <esp_event_loop.h>`

See also:

- Handling WiFi events
- esp\_event\_loop\_init

### **esp\_wifi\_ap\_get\_sta\_list**

```
esp_err_t esp_wifi_ap_get_sta_list(wifi_sta_list_t* sta)
```

## esp\_wifi\_clear\_fast\_connect

Not implemented.

```
esp_err_t esp_wifi_clear_fast_connect()
```

## esp\_wifi\_connect

Connect to an access point.

```
esp_err_t esp_wifi_connect()
```

Prior to calling this function we should have:

- Initialized WiFi – `esp_wifi_init()`
- Set our mode to be either a station or station+ap – `esp_wifi_set_mode()`
- Set our desired access point connection information – `esp_wifi_set_config()`
- Started the WiFi subsystem – `esp_wifi_start()` and received a `SYSTEM_EVENT_STA_START` event message.

It is very important to realize that we can't just call `esp_wifi_start()` and then immediately turn around and call `esp_wifi_connect()`. We **must** wait for the start event to have signaled completion.

We can disconnect from an access point by calling `esp_wifi_disconnect()`. Experience seems to show that before we can connect to a new access point, we must first explicitly disconnect from a previous access point.

Includes:

- `#include <esp_wifi.h>`

See also:

- Connecting to an access point
- `esp_wifi_init`
- `esp_wifi_set_mode`
- `esp_wifi_set_config`
- `esp_wifi_start`
- `esp_wifi_disconnect`

## esp\_wifi\_deauth\_sta

De-authenticate stations.

```
esp_err_t esp_wifi_deauth_sta(uint16_t aid)
```

If aid is 0, all stations will be de-authenticated. If aid is a value, just that station will be de-authenticated.

Includes:

- `#include <esp_wifi.h>`

### **esp\_wifi\_deinit**

Release the ESP32 WiFi environment.

```
esp_err_t esp_wifi_deinit()
```

Includes:

- `#include <esp_wifi.h>`

See also:

- `esp_wifi_init`

### **esp\_wifi\_disconnect**

Disconnect from an access point.

```
esp_err_t esp_wifi_disconnect()
```

We assume that we have previously connected to an access point using

```
esp_wifi_connect().
```

Includes:

- `#include <esp_wifi.h>`

See also:

- `Connecting to an access point`
- `esp_wifi_connect`

### **esp\_wifi\_free\_station\_list**

Release the storage for the previously returned list of stations.

```
esp_err_t esp_wifi_free_station_list()
```

Includes:

- `#include <esp_wifi.h>`

See also:

- `Working with connected stations`
- `esp_wifi_get_station_list`

### **esp\_wifi\_get\_auto\_connect**

Determine whether or not auto connect at boot is enabled.

```
esp_err_t esp_wifi_set_auto_connect(bool *enabled)
```

Includes:

- esp\_wifi.h

See also:

- Connecting to an access point
- esp\_wifi\_set\_auto\_connect

### **esp\_wifi\_get\_bandwidth**

Get the current bandwidth.

```
esp_err_t esp_wifi_get_bandwidth(wifi_interface_t ifx, wifi_bandwidth_t *bandWidth)
```

Includes:

- #include <esp\_wifi.h>

See also:

- esp\_wifi\_set\_bandwidth

### **esp\_wifi\_get\_channel**

Get the current channel.

```
esp_err_t esp_wifi_get_channel(uint8_t *primary, wifi_second_chan_t *second)
```

Includes:

- #include <esp\_wifi.h>

See also:

- esp\_wifi\_set\_channel

### **esp\_wifi\_get\_config**

Retrieve the current connection information associated with the specified WiFi interface.

```
esp_err_t esp_wifi_get_config(wifi_interface_t interface, wifi_config_t *conf)
```

The interface is one of:

- WIFI\_IF\_STA – The station interface.

- `WIFI_IF_AP` – The access point interface.

The `conf` parameter is populated with the current configuration. See the details of `esp_wifi_set_config` for the nature and content of this data type.

Includes:

- `#include <esp_wifi.h>`

See also:

- `esp_wifi_set_config`

### **esp\_wifi\_get\_country**

Retrieve the currently configured WiFi country.

```
esp_err_t esp_wifi_get_country(wifi_country_t *country)
```

The default WiFi country is China. Allowable values are:

- `WIFI_COUNTRY_CN`
- `WIFI_COUNTRY_JP`
- `WIFI_COUNTRY_US`
- `WIFI_COUNTRY_EU`

Includes:

- `#include <esp_wifi.h>`

See also:

- `esp_wifi_set_country`

### **esp\_wifi\_get\_event\_mask**

```
esp_err_t esp_wifi_get_event_mask(uint32_t *mask)
```

Includes:

- `#include <esp_wifi.h>`

See also:

- `esp_wifi_set_event_mask`

### **esp\_wifi\_get\_mac**

Retrieve the current MAC address for the interface.

```
esp_err_t esp_wifi_get_mac(wifi_interface_t interface, uint8_t mac[6])
```

The `interface` is one of:

- `WIFI_IF_STA` – The station interface.
- `WIFI_IF_AP` – The access point interface.

Includes:

- `#include <esp_wifi.h>`

See also:

- `esp_wifi_set_mac`

### **esp\_wifi\_get\_mode**

Get the WiFi operating mode.

```
esp_err_t esp_wifi_get_mode(wifi_mode_t *mode)
```

Get the operating WiFi mode. The choices available are:

- `WIFI_MODE_NULL` – No WiFi.
- `WIFI_MODE_STA` – A station.
- `WIFI_MODE_AP` – An access point.
- `WIFI_MODE_APSTA` – Both a station and an access point.

Includes:

- `#include <esp_wifi.h>`

See also:

- Setting the operation mode
- Station configuration
- `esp_wifi_set_mode`
- `esp_wifi_set_config`

### **esp\_wifi\_get\_promiscuous**

```
esp_err_t esp_wifi_get_promiscuous(uint8_t *enable)
```

Includes:

- `#include <esp_wifi.h>`

See also:

- `esp_wifi_set_promiscuous`

### **esp\_wifi\_get\_protocol**

Get the 802.11 protocol (b/g/n).

```
esp_err_t esp_wifi_get_protocol(wifi_interface_t ifx, uint8_t *protocolBitmap)
```

The possible protocols are:

- WIFI\_PROTOCOL\_11B
- WIFI\_PROTOCOL\_11G
- WIFI\_PROTOCOL\_11N
- WIFI\_PROTOCOL\_LR

Includes:

- `#include <esp_wifi.h>`

See also:

- `esp_wifi_set_protocol`

### **esp\_wifi\_get\_ps**

Get the power save type.

```
esp_err_t esp_wifi_get_ps(wifi_ps_type_t *type)
```

The type of power save will be one of:

- WIFI\_PS\_NONE –
- WIFI\_PS\_MODEM –
- WIFI\_PS\_LIGHT –
- WIFI\_PS\_MAC –

Includes:

- `#include <esp_wifi.h>`

See also:

- `esp_wifi_set_ps`

### **esp\_wifi\_get\_station\_list**

Get the list of stations connected to ESP32 when it is behaving as an access point.

```
esp_err_t esp_wifi_get_station_list(wifi_sta_list_t **station)
```

The structure of a "struct station\_info" is:

```
STAILQ_ENTRY(station_info) next
uint8_t bssid[6]
```

To walk through this list we can use the following algorithm:

```
wifi_sta_list_t *stations;
//
while (stations != NULL) {
    printf("bssid: %.2x:%.2x:%.2x:%.2x:%.2x:%.2x\n",
        stations->bssid[0],stations->bssid[1],stations->bssid[2],
        stations->bssid[3],stations->bssid[4],stations->bssid[5]);
    stations = STAILQ_NEXT(stations, next);
}
```

Includes:

- `#include <esp_wifi.h>`

See also:

- Working with connected stations
- `esp_wifi_free_station_list`
- `tcpip_adapter_get_sta_list`

## esp\_wifi\_init

Initialize the ESP32 WiFi environment.

```
esp_err_t esp_wifi_init(wifi_init_config_t *config)
```

This API call should be invoked before all other WiFi related calls. The `wifi_init_config_t` contains:

```
void * event_q
uint8_t rx_ba_win
uint8_t rx_ba_win
uint8_t rx_ba_win
```

A macro called `WIFI_INIT_CONFIG_DEFAULT` can be used to initialize the configuration structure. For example:

```
wifi_init_config_t config = WIFI_INIT_CONFIG_DEFAULT();
esp_wifi_init(&config);
```

Includes:

- `#include <esp_wifi.h>`

See also:



- Initializing the WiFi environment
- `esp_wifi_start`
- `esp_wifi_deinit`

### **esp\_wifi\_restore**

```
esp_err_t esp_wifi_restore()
```

### **esp\_wifi\_reg\_rxcb**

```
esp_err_t esp_wifi_reg_rxcb(wifi_interface_t ifx, wifi_rxcb_t fn)
```

Includes:

- `#include <esp_wifi.h>`

### **esp\_wifi\_scan\_get\_ap\_records**

Retrieve the access points found in a previous scan.

```
esp_err_t esp_wifi_scan_get_ap_records(uint16_t *number, wifi_ap_record_t *apRecords);
```

The `apList` is a contiguous chunk of storage capable of holding objects of type `wifi_ap_record_t`. The number of such records is the initial value of the number parameter. On return, the actual number of items will be updated.

This command is usually called as a result of a previous scan. This is a destructive read meaning that after calling this function, the data that was previously stored and maintained by the ESP-IDF will be released as a copy has now been made available to the caller.

A `wifi_ap_record_t` record contains:

```

        uint8_t bssid[6]
        uint8_t ssid[32]
        uint8_t primary
wifi_second_chan_t second
        int8_t rssi
        wifi_auth_mode_t authmode
wifi_cipher_type_t pairwise_cipher
wifi_cipher_type_t group_cipher
        uint32_t phy_11b:1
        uint32_t phy_11g:1
        uint32_t phy_11n:1
        uint32_t phy_lr:1
        uint32_t wps:1

```

The `authmode` can be one of:

- `WIFI_AUTH_OPEN` –
- `WIFI_AUTH_WEP` –
- `WIFI_AUTH_WPA_PSK` –
- `WIFI_AUTH_WPA2_PSK` –
- `WIFI_AUTH_WPA_WPA2_PSK` –

Includes:

- `#include <esp_wifi.h>`

See also:

- Scanning for access points
- `esp_wifi_scan_stop`

### `esp_wifi_scan_get_ap_num`

Retrieve the count of found access points from a previous scan.

```
esp_err_t esp_wifi_scan_get_ap_num(uint16_t *number)
```

Retrieve the number of discovered access points from the previous scan. We need to be careful that the scan has completed before getting the count.

Includes:

- `#include <esp_wifi.h>`

See also:

- Scanning for access points

## **esp\_wifi\_scan\_start**

Scan for access points.

```
esp_err_t esp_wifi_scan_start(wifi_scan_config_t* conf, bool block)
```

Govern how the scan should be performed. The `wifi_scan_config_t` contains the following fields:

```
char * ssid
uint8_t * bssid
uint8_t channel
bool show_hidden
```

The `block` parameter defines whether or not this call blocks until the data is available.

The results of a WiFi scan are stored internally in ESP32 dynamically allocated storage. The data is returned to us when we call `esp_wifi_get_ap_list()` which also releases the internally allocated storage. As such, this should be considered a destructive read.

Includes:

- `#include <esp_wifi.h>`

See also:

- Scanning for access points
- `esp_wifi_scan_stop`

## **esp\_wifi\_scan\_stop**

Stop an access point scan that is in progress.

```
esp_err_t esp_wifi_scan_stop()
```

By calling `esp_wifi_scan_start()`, we can request that a WiFi scan be performed in the background. Should we wish to interrupt or stop that activity, this function can be used.

Includes:

- `#include <esp_wifi.h>`

See also:

- Scanning for access points
- `esp_wifi_scan_start`
- Error: Reference source not found
- `esp_wifi_set_config`

### **esp\_wifi\_set\_auto\_connect**

```
esp_err_t esp_wifi_set_auto_connect(bool enabled)
```

Includes:

- `#include <esp_wifi.h>`

See also:

- Connecting to an access point
- `esp_wifi_get_auto_connect`

### **esp\_wifi\_set\_bandwidth**

Set the current bandwidth.

```
esp_err_t esp_wifi_set_bandwidth(
    wifi_interface_t interface,
    wifi_bandwidth_t bandWidth)
```

The interface is one of:

- `WIFI_IF_STA` – The station interface.
- `WIFI_IF_AP` – The access point interface.

The `bandWidth` parameter can be one of:

- `WIFI_BW_HT20` –
- `WIFI_BW_HT40` –

Includes:

- `#include <esp_wifi.h>`

See also:

- `esp_wifi_get_bandwidth`

### **esp\_wifi\_set\_channel**

```
esp_err_t esp_wifi_set_channel(uint8_t primary, wifi_second_chan_t second)
```

Includes:

- `#include <esp_wifi.h>`

See also:

- `esp_wifi_get_channel`

## **esp\_wifi\_set\_config**

Set the WiFi interface configuration.

```
esp_err_t esp_wifi_set_config(
    wifi_interface_t interface,
    wifi_config_t* conf)
```

The interface is one of:

- `WIFI_IF_STA` – The station interface.
- `WIFI_IF_AP` – The access point interface.

The choice of which interface will be used will be dependent on whether or not we are being an access point, a station or both. If a station, we will configure the station interface, if an access point, we will configure the access point interface and if both, then we will configure both interfaces. We should previously have called `esp_wifi_set_mode()`.

The `wifi_config_t` defines properties of the interface. It is a C language union of `wifi_ap_config_t` and `wifi_sta_config_t`.

The `wifi_sta_config_t` contains:

```
        char ssid[32]
        char password[64]
    wifi_scan_method_t scan_method
        bool bssid_set
        uint8_t bssid[6]
        uint8_t channel
        wifi_sort_method_t sort_method
    wifi_fast_scan_threshold threshold
```

An example initialization for this structure might be:

```
wifi_config_t staConfig = {
    .sta = {
        .ssid="<access point name>",
        .password="<password>",
        .bssid_set=false
    }
};
```

The `wifi_ap_config_t` contains:

```
        char ssid[32]
        char password[64]
        uint8_t ssid_len
        uint8_t channel
wifi_auth_mode_t authmode
        uint8_t ssid_hidden
        uint8_t max_connection
        uint16_t beacon_interval
```

If `ssid_len` is 0, then look for a string termination character in the `ssid` field. Otherwise if `ssid_len` is greater than 0, the value defines the number of bytes in `ssid` to read for the `ssid` value.

The `password` is the password used to authenticate with the access point. Reports have said that the password needs to be at least 8 character long. This has not yet been verified but may be worth considering if you try and use a password shorter than this.

The `channel` is the channel we are using for WiFi.

The `authmode` indicates how stations can connect. Options include:

- `WIFI_AUTH_OPEN`
- `WIFI_AUTH_WEP`
- `WIFI_AUTH_WPA_PSK`
- `WIFI_AUTH_WPA2_PSK`
- `WIFI_AUTH_WPA_WPA2_PSK`

The `ssid_hidden` is 0 meaning that the SSID is broadcast and can be found.

The `max_connection` is the maximum number of stations that can connect. The default is 4.

The `beacon_interval` is some magic related to WiFi and should have a default value of 100.

An example of initialization of this structure might be:

```
wifi_config_t apConfig = {
    .ap = {
        .ssid="<access point name>",
        .password="<password>",
        .ssid_len=0,
        .channel=0,
        .authmode=WIFI_AUTH_OPEN,
        .ssid_hidden=0,
```

```
        .max_connection=4,  
        .beacon_interval=100  
    }  
};
```

Includes:

- `#include <esp_wifi.h>`

See also:

- `esp_wifi_get_config`
- Being an access point
- Station configuration

### `esp_wifi_set_country`

Set the WiFi country.

```
esp_err_t esp_wifi_set_country(wifi_country_t country)
```

The default WiFi country is China. Allowable values are:

- `WIFI_COUNTRY_CN` – China.
- `WIFI_COUNTRY_JP` – Japan.
- `WIFI_COUNTRY_US` – United States of America.
- `WIFI_COUNTRY_EU` – European Union.

Includes:

- `#include <esp_wifi.h>`

See also:

- `esp_wifi_get_country`

### `esp_wifi_set_event_mask`

Choose which events will **not** be delivered.

```
esp_err_t esp_wifi_set_event_mask(uint32_t mask)
```

See also:

- `esp_wifi_get_event_mask`

### `esp_wifi_set_mac`

```
esp_err_t esp_wifi_set_mac(wifi_interface_t ifx, uint8_t mac[6])
```

Includes:

- `#include <esp_wifi.h>`

See also:

- `esp_wifi_get_mac`

## **esp\_wifi\_set\_mode**

Set the operating mode.

```
esp_err_t esp_wifi_set_mode(wifi_mode_t mode)
```

Set the operating WiFi mode. The choices are:

- `WIFI_MODE_NULL` – No WiFi.
- `WIFI_MODE_STA` – A station.
- `WIFI_MODE_AP` – An access point.
- `WIFI_MODE_APSTA` – Both a station and an access point.

You will also need to call `esp_wifi_set_config()` to specify the configuration parameters. If we are being an access point, we will not actually start listening for stations until after `esp_wifi_start()` and if we are being a station, we will not connect to an access point until after a call to `esp_wifi_start()` and then `esp_wifi_connect()`.

Includes:

- `#include <esp_wifi.h>`

See also:

- Setting the operation mode
- Station configuration
- `esp_wifi_get_mode`
- `esp_wifi_set_config`

## **esp\_wifi\_set\_promiscuous\_rx\_cb**

```
esp_err_t esp_wifi_set_promiscuous_rx_cb(wifi_promiscuous_cb_t cb)
```

Includes:

- `#include <esp_wifi.h>`

See also:

## **esp\_wifi\_set\_promiscuous**

```
esp_err_t esp_wifi_set_promiscuous(uint8_t enable)
```



Includes:

- `#include <esp_wifi.h>`

See also:

- `esp_wifi_get_promiscuous`

### **esp\_wifi\_set\_protocol**

Set the 802.11 protocol (b/g/n)

```
esp_err_t esp_wifi_set_protocol(wifi_interface_t ifx, uint8_t protocolBitmap)
```

The allowable protocols are:

- `WIFI_PROTOCOL_11B`
- `WIFI_PROTOCOL_11G`
- `WIFI_PROTOCOL_11N`
- `WIFI_PROTOCOL_LR`

Includes:

- `#include <esp_wifi.h>`

See also:

- `esp_wifi_get_protocol`

### **esp\_wifi\_set\_ps**

Set the power save type.

```
esp_err_t esp_wifi_set_ps(wifi_ps_type_t type)
```

The type of power save will be one of:

- `WIFI_PS_NONE` —
- `WIFI_PS_MODEM` —
- `WIFI_PS_LIGHT` —
- `WIFI_PS_MAC` —

Includes:

- `#include <esp_wifi.h>`

See also:

- `esp_wifi_get_ps`

## **esp\_wifi\_set\_storage**

Define where WiFi configuration will be stored.

```
esp_err_t esp_wifi_set_storage(wifi_storage_t storage)
```

The options available are:

- `WIFI_STORAGE_FLASH` – Configuration stored in both flash and RAM. This is the default.
- `WIFI_STORAGE_RAM` – Configuration stored in RAM only (not in flash as well).

The value of this method is that we can choose to save our configuration set by `esp_wifi_set_config()` to RAM or both flash and RAM. If we save our settings in flash then it is these settings that will be used during an auto connect when we call `esp_wifi_set_auto_connect()` to connect at start up.

Includes:

- `#include <esp_wifi.h>`

See also:

- Connecting to an access point
- `esp_wifi_set_config`
- `esp_wifi_set_auto_connect`

## **esp\_wifi\_set\_vendor\_ie**

```
esp_err_t esp_wifi_set_vendor_ie(  
    bool          enable,  
    wifi_vendor_ie_type_t type,  
    wifi_vendor_ie_id_t  idx,  
    uint8_t*      vnd_ie)
```

Includes:

- `#include <esp_wifi.h>`

## **esp\_wifi\_set\_vendor\_ie\_cb**

```
esp_err_t esp_wifi_set_vendor_ie_cb(  
    esp_vendor_ie_cb_t cb,  
    void *ctx)
```

Includes:

- `#include <esp_wifi.h>`

## **esp\_wifi\_sta\_get\_ap\_info**

Get information about the access point to which we are connected,

```
esp_err_t esp_wifi_sta_get_ap_info(wifi_ap_record_t *apInfo)
```

## **esp\_wifi\_start**

Start the WiFi subsystem.

```
esp_err_t esp_wifi_start()
```

Prior to calling this function, we should have called `esp_wifi_init()` and configured our mode (`esp_wifi_set_mode`) and interfaces (`esp_wifi_set_config`). If we are an access point, then after calling this function, we will start to accept incoming client connections.

We should not attempt to perform any further networking or WiFi commands until after we have received the corresponding event saying that the start command has completed.

Includes:

- `#include <esp_wifi.h>`

See also:

- Starting up the WiFi environment
- `esp_wifi_stop`
- `esp_wifi_init`
- `esp_wifi_set_mode`

## **esp\_wifi\_stop**

Stop the WiFi subsystem.

```
esp_err_t esp_wifi_stop()
```

This will stop the ESP32 WiFi subsystem. This could be called after a previous `esp_wifi_start()` call.

Includes:

- `#include <esp_wifi.h>`

See also:

- Starting up the WiFi environment
- `esp_wifi_start`

## WiFi WPS

### wifi\_wps\_enable

```
bool wifi_wps_enable(WPS_TYPE_t wps_type)
```

The type parameter can be one of the following:

- WPS\_TYPE\_DISABLE – Unsupported
- WPS\_TYPE\_PBC – Push Button Configuration – Supported
- WPS\_TYPE\_PIN – Unsupported
- WPS\_TYPE\_DISPLAY – Unsupported
- WPS\_TYPE\_MAX – Unsupported

See also:

- WiFi Protected Setup – WPS

### wifi\_wps\_disable

```
bool wifi_wps_disable()
```

See also:

- WiFi Protected Setup – WPS

### wifi\_wps\_start

```
bool wifi_wps_start()
```

See also:

- WiFi Protected Setup – WPS

### wifi\_set\_wps\_cb

```
bool wifi_set_wps_cb(wps_st_cb_t callback)
```

The signature of the callback function is:

```
void (*functionName)(int status)
```

The status parameter will be one of:

- WPS\_CB\_ST\_SUCCESS –
- WPS\_CB\_ST\_FAILED –
- WPS\_CB\_ST\_TIMEOUT –

See also:

- [WiFi Protected Setup – WPS](#)

## **mbed TLS**

The mbed TLS is an implementation of SSL/TLS security and is supplied with ESP-IDF.

See also:

- [TLS, SSL and security](#)
- [mbed TLS home page](#)
- [mbed TLS tutorial](#)

### **MBEDTLS\_CTR\_DRBG\_FREE**

```
void mbedtls_ctr_drbg_free(mbedtls_ctr_drbg_context *ctx)
```

### **MBEDTLS\_CTR\_DRBG\_INIT**

```
void mbedtls_ctr_drbg_init(mbedtls_ctr_drbg_context *ctx)
```

Includes:

- `#include <mbedtls/ctr_drbg.h>`

### **MBEDTLS\_CTR\_DRBG\_SEED**

Initial seeding.

```
int mbedtls_ctr_drbg_seed(
    mbedtls_ctr_drbg_context *ctx,
    int (*)(void *, unsigned char *, size_t) f_entropy,
    void *p_entropy,
    const unsigned char *custom,
    size_t len)
```

Includes:

- `mbedtls/ctr_drbg.h`

### **MBEDTLS\_DEBUG\_SET\_THRESHOLD**

Set the debug level.

```
void mbedtls_debug_set_threshold(int threshold)
```

Set the level of debugging to be generated from the library. The threshold value can be one of:

- 0 – no debug
- 1 – error
- 2 – state change
- 3 – informational
- 4 – verbose

A higher level captures that level and the entries of lower level.

**Note:** To use this function, mbedTLS debugging must be enabled by editing the Curl `mbedtls.c`.

Includes:

- `#include <mbedtls/debug.h>`

See also:

- `mbedtls_ssl_conf_dbg`
- `mbedtls_strerror`

### **mbedtls\_entropy\_free**

```
void mbedtls_entropy_free(mbedtls_entropy_context *ctx)
```

Includes:

- `mbed/entropy.h`

### **mbedtls\_entropy\_init**

```
void mbedtls_entropy_init(mbedtls_entropy_context *ctx)
```

Includes:

- `#include <mbedtls/entropy.h>`

### **mbedtls\_net\_accept**

```
int mbedtls_net_accept(  
    mbedtls_net_context* bind_ctx,  
    mbedtls_net_context* client_ctx,  
    void* client_ip,  
    size_t buf_size,  
    size_t* ip_len)
```

Block on the given network endpoint waiting for a new partner connection. Compare this to the `accept()` system call in sockets.

- `bind_ctx` – A pointer to the network context (file descriptor) that is bound to a local address. This is the socket on which we are listening for incoming connections.
- `client_ctx` – A pointer to the network context (file descriptor) that will be filled in with the new connection to our partner when a connection arrives.
- `client_ip` – A pointer to data that will hold the address of the newly connected partner. Can be NULL if we don't care.
- `buf_size` – The size of the buffer pointed to by `client_ip` into which the address of the newly connected partner will be stored. Can be 0 if we don't care.
- `ip_len` – The length of the completed address of the partner. Can be NULL if we don't care.

Returns 0 on success.

Example:

```
int rc = mbedtls_net_accept(&serverCtx, &clientCtx, NULL, 0, NULL);
```

### **mbedtls\_net\_bind**

```
int mbedtls_net_bind(
    mbedtls_net_context* ctx,
    const char*         bind_ip,
    const char*         port,
    int                 proto
)
```

The `proto` is one of `MBEDTLS_NET_PROTO_TCP` or `MBEDTLS_NET_PROTO_UDP`.

### **mbedtls\_net\_connect**

Initiate a network connection.

```
int mbedtls_net_connect(
    mbedtls_net_context *context,
    const char *host,
    const char *port,
    int proto)

```

The `context` is the network context to use, `host` is the host to connect to, `port` is the port number (as a string) and `proto` is one of `MBEDTLS_NET_PROTO_TCP` or `MBEDTLS_NET_PROTO_UDP`.

Includes:

- `mbed/net.h`

See also:

- `mbedtls_net_init`

### **`mbedtls_net_free`**

Gracefully shutdown the connection and release data.

```
void mbedtls_net_free(mbedtls_net_context* context)
```

Release any resources associated with the context. A call to `mbedtls_net_init()` will have been called prior to this release call.

See also:

- `mbedtls_net_init`

### **`mbedtls_net_init`**

Initialize a context for use.

```
void mbedtls_net_init(mbedtls_net_context* context)
```

Invoke this function early to initialize the context. Don't try and use a context before calling this function.

Includes:

- `#include <mbed/net.h>`

See also:

- `mbedtls_net_free`

### **`mbedtls_net_recv`**

Read data from a socket.

```
int mbedtls_net_recv(  
    void*          ctx,  
    unsigned char* buf,  
    size_t         len  
)
```

See also:

- `mbedtls_net_send`
- `mbedtls_ssl_set_bio`



## **MBEDTLS\_NET\_RECV\_TIMEOUT**

```
int mbedtls_net_recv_timeout(  
    void*          ctx,  
    unsigned char* buf,  
    size_t         len,  
    uint32_t       timeout  
)
```

### **See also:**

- `mbedtls_net_recv`
- `mbedtls_net_send`
- `mbedtls_ssl_set_bio`

## **MBEDTLS\_NET\_SEND**

Send data down a socket.

```
int mbedtls_net_send(  
    void*          ctx,  
    const unsigned char* buf,  
    size_t         len)
```

### **See also:**

- `mbedtls_net_recv`
- `mbedtls_net_recv_timeout`
- `mbedtls_ssl_set_bio`

## **MBEDTLS\_NET\_SET\_BLOCK**

```
int mbedtls_net_set_block(mbedtls_net_context* ctx)
```

## **MBEDTLS\_NET\_SET\_NONBLOCK**

```
int mbedtls_net_set_nonblock(mbedtls_net_context* ctx)
```

## **MBEDTLS\_PK\_DECRYPT**

```
int mbedtls_pk_decrypt(  
    mbedtls_pk_context* ctx,  
    const unsigned char *input,  
    size_t ilen,  
    unsigned char *output,  
    size_t *olen,  
    size_t osize,  
    int(*f_rng)(void *, unsigned char *, size_t),  
    void *p_rng)
```

Includes:

- `#include <mbedtls/pk.h>`

### **mbedtls\_pk\_encrypt**

```
int mbedtls_pk_encrypt(
    mbedtls_pk_context* ctx,
    const unsigned char* input,
    size_t ilen,
    unsigned char* output,
    size_t olen,
    size_t osize,
    int(*f_rng)(void *, unsigned char*, size_t),
    void* p_rng)
```

- `ctx` – PK context to use.
- `input` – Message to encrypt.
- `ilen` – Size of message to be encrypted.
- `output` – Encrypted output.
- `olen` – Size of resulting encrypted data. This is an output parameter.
- `osize` – Size of output data.
- `f_rng` – RNG function.
- `p_rng` – RNG parameter.

Returns 0 on success.

Includes:

- `#include <mbedtls/pk.h>`

### **mbedtls\_pk\_free**

```
void mbedtls_pk_free(mbedtls_pk_context* ctx)
```

Includes:

- `#include <mbedtls/pk.h>`

### **mbedtls\_pk\_get\_len**

```
size_t mbedtls_pk_get_len(const mbedtls_pk_context* ctx)
```

Includes:

- `#include <mbedtls/pk.h>`

### **mbedtls\_pk\_get\_name**

Get the name of the type of `pk_context`.

```
const char* mbedtls_pk_get_name(const mbedtls_pk_context* ctx)
```

The name of the contained in the context. For example "RSA".

Includes:

- `#include <mbedtls/pk.h>`

### **mbedtls\_pk\_info\_from\_type**

Return data for the associated pk type.

```
const mbedtls_pk_info_t* mbedtls_pk_info_from_type(mbedtls_pk_type_t pk_type)
```

The type can be one of:

- `MBEDTLS_PK_NONE`
- `MBEDTLS_PK_RSA`
- others ...

Includes:

- `#include <mbedtls/pk.h>`

See also:

- `mbedtls_pk_setup`

### **mbedtls\_pk\_init**

Initialize a pk context.

```
void mbedtls_pk_init(mbedtls_pk_context* ctx)
```

Includes:

- `#include <mbedtls/pk.h>`

### **mbedtls\_pk\_parse\_key**

Parse a private key in PEM or DER format.

```
int mbedtls_pk_parse_key(  
    mbedtls_pk_context* ctx,  
    const unsigned char* key,  
    size_t keylen,
```

```
const unsigned char* pwd,  
size_t                pwrlen  
)
```

- `ctx` – Key to be initialized
- `key` – input buffer
- `keylen` – size of the key buffer. If we are passing in a PEM then this must **include** the '\0' byte at the end.
- `pwd` – password for decryption
- `pwrlen` – size of the password

On entry the context must have been just created with `mbedtls_pk_init()` or cleaned with `mbedtls_pk_free()`.

I must stress the inclusion of the null terminator for PEM data. If we use `xxd` to generate hard-coded keys, this is NOT included by default.

Returns 0 on success.

Includes:

- `#include <mbedtls/pk.h>`

See also:

- RSA encryption/decryption
- `mbedtls_pk_init`

### `mbedtls_pk_rsa_context`

Retrieve an RSA context.

```
static mbedtls_rsa_context* mbedtls_pk_rsa(const mbedtls_pk_context pk)
```

Includes:

- `#include <mbedtls/pk.h>`

### `mbedtls_pk_setup`

Initialize a PK context with information.

```
int mbedtls_pk_setup(mbedtls_pk_context* ctx, const mbedtls_pk_info_t* info)
```

Includes:

- `#include <mbedtls/pk.h>`

See also:

- `mbedtls_pk_info_from_type`

### `mbedtls_pk_write_key_der`

Write a private key to a DER structure.

```
int mbedtls_pk_write_pubkey_der(
    mbedtls_pk_context* ctx,
    unsigned char*      buf,
    size_t              size)
```

The `ctx` is the context which contains the key. The `buf` is a buffer into which to write the DER formatted data. The `size` is the size of the buffer in bytes.

Strangely, the DER data is written from the end of the buffer backwards. So the start of the data will be:

```
buf + size - rc
```

The return is the length of the data used (if positive).

See also:

- `mbedtls_pk_write_pubkey_der`
- `mbedtls_pk_write_pubkey_pem`
- `mbedtls_pk_write_key_pem`

### `mbedtls_pk_write_key_pem`

Write a private key to a PEM string.

```
int mbedtls_pk_write_key_pem(
    mbedtls_pk_context* ctx,
    unsigned char*      buf,
    size_t              size)
```

The `ctx` is the context which contains the key. The `buf` is a buffer into which to write the PEM formatted string. The `size` is the size of the buffer in bytes.

Returns 0 on success.

Includes:

- `#include <mbedtls/pk.h>`

### `mbedtls_pk_write_pubkey_der`

Write a public key to a DER structure.

```
int mbedtls_pk_write_pubkey_der(
    mbedtls_pk_context* ctx,
    unsigned char*      buf,
    size_t              size)
```

The `ctx` is the context which contains the key. The `buf` is a buffer into which to write the DER formatted data. The `size` is the size of the buffer in bytes.

Strangely, the DER data is written from the end of the buffer backwards. So the start of the data will be:

```
buf + size - rc
```

The return is the length of the data used (if positive). Empirical sizes seem to show:

- 1024 bits – 607 bytes

Includes:

- `#include <mbedtls/pk.h>`

### **mbedtls\_pk\_write\_pubkey\_pem**

Write a public key to a PEM string.

```
int mbedtls_pk_write_pubkey_pem(
    mbedtls_pk_context* ctx,
    unsigned char*      buf,
    size_t              size)
```

The `ctx` is the context which contains the key. The `buf` is a buffer into which to write the PEM formatted string. The `size` is the size of the buffer in bytes.

Returns 0 on success.

Includes:

- `#include <mbedtls/pk.h>`

### **mbedtls\_printf**

Printf macro.

Includes:

- `mbed/platform.h`

### **mbedtls\_sha1**

Produce a 160bit (20 byte) hash value.

```
void mbedtls_sha1(const unsigned char* input, size_t ilen, unsigned char output[20])
```

The `input` is the pointer to the data to be hashed. The `ilen` is the length of the input. The `output` is the resulting hash.

Includes:

- `#include <mbedtls/sha1.h>`

### **mbedtls\_rsa\_check\_privkey**

Validate that an `mbedtls_rsa_context` contains a private key.

### **mbedtls\_rsa\_check\_pubkey**

Validate that an `mbedtls_rsa_context` contains a public key.

### **mbedtls\_rsa\_free**

Frees components of an RSA key.

### **mbedtls\_rsa\_gen\_key**

Generate an RSA keypair.

```
int mbedtls_rsa_gen_key(
    mbedtls_rsa_context    ctx,
    int() (void*, unsigned char*, size_t) f_rng,
    void*                  p_rng,
    unsigned int           nbits,
    int                    exponent)
```

The `ctx` must be initialized with a preceding call to `mbedtls_rsa_init()`.

Includes:

- `#include <mbedtls/rsa.h>`

See also:

- Generate DER data containing a private key
- `mbedtls_rsa_init`
- [RSA Key Pair generator](#)

### **mbedtls\_rsa\_init**

```
void mbedtls_rsa_init(
    mbedtls_rsa_context* ctx,
    int padding,
    int hash_id)
```

Padding is one of `MBEDTLS_RSA_PKCS_V15` or `MBEDTLS_RSA_PKCS_V21`. When padding is `MBEDTLS_RSA_PKCS_V15`, the `hash_id` is 0.

Includes:

- `#include <mbedtls/rsa.h>`

See also:

### **mbedtls\_rsa\_pkcs\_encrypt**

```
int mbedtls_rsa_pkcs1_encrypt(
    mbedtls_rsa_context *ctx,
    int(*) (void *, unsigned char *, size_t) f_rng,
    void* p_rng,
    int mode,
    size_t ilen,
    const unsigned char* input,
    unsigned char* output)
```

- `ctx` – The RSA context.
- `f_rng` – The RNG function.
- `p_rng` – The parameter to the RNG function.
- `mode` – `MBEDTLS_RSA_PUBLIC`
- `ilen` – The length of the plain text.
- `input` – The buffer holding the plain text.
- `output` – The buffer holding the cipher text.

Includes:

- `#include <mbedtls/rsa.h>`

### **mbedtls\_ssl\_close\_notify**

Notify the peer that the connection is being closed.

```
int mbedtls_ssl_close_notify(mbedtls_ssl_context* ssl)
```

The return is 0 on success.

### **mbedtls\_ssl\_conf\_authmode**

Set the certificate verification mode.



```
void mbedtls_ssl_conf_authmode(
    mbedtls_ssl_config* sslConf,
    int authmode)
```

The `sslConf` is the SSL configuration. The `authmode` is one of:

- `MBEDTLS_SSL_VERIFY_NONE` –
- `MBEDTLS_SSL_VERIFY_OPTIONAL` –
- `MBEDTLS_SSL_VERIFY_REQUIRED` –

Includes:

- `mbed/ssl.h`

## `mbedtls_ssl_conf_ca_chain`

### `mbedtls_ssl_conf_dbg`

Set the debug callback.

```
void mbedtls_ssl_conf_dbg(
    mbedtls_ssl_config *conf,
    void(*func)(void *debugContext, int level, char *file, int line, const char *str),
    void *debugContext)
```

An example of a function that can be used to log data might be:

```
static void my_debug(
    void *ctx,
    int level,
    const char *file,
    int line,
    const char *str) {

    ((void) level);
    ((void) ctx);
    printf("%s:%04d: %s", file, line, str);
}
```

See also:

- `mbedtls_debug_set_threshold`
- `mbedtls_strerror`

### `mbedtls_ssl_conf_rng`

Set the random number generator callback.

```
void mbedtls_ssl_conf_rng(
    mbedtls_ssl_config conf,
```

```
int(*) (void *, unsigned char *, size_t) f_rng,  
void *p_rng)
```

Includes:

- mbed/ssl.h

### **mbedtls\_ssl\_config\_defaults**

```
int mbedtls_ssl_config_defaults(  
    mbedtls_ssl_config *sslConfig,  
    int endpoint,  
    int transport,  
    int preset)
```

The `endpoint` is one of `MBEDTLS_SSL_IS_CLIENT` or `MBEDTLS_SSL_IS_SERVER`.

The `transport` is `MBEDTLS_SSL_TRANSPORT_STREAM` or `MBEDTLS_SSL_TRANSPORT_DATAGRAM`.

The `preset` is currently not used. Supply `MBEDTLS_SSL_PRESET_DEFAULT`.

Includes:

- mbed/ssl.h

### **mbedtls\_ssl\_config\_free**

Release the resources for an SSL configuration context.

```
void mbedtls_ssl_config_free(mbedtls_ssl_config *sslConf)
```

Includes:

- mbed/ssl.h

See also:

- `mbedtls_ssl_config_init`

### **mbedtls\_ssl\_config\_init**

Initialize an SSL Config record.

```
void mbedtls_ssl_config_init(mbedtls_ssl_config* sslConf)
```

Includes:

`#include <mbed/ssl.h>`

See also:

- `mbedtls_ssl_config_free`

## **MBEDTLS\_SSL\_FREE**

Release resources for an SSL context.

```
void mbedtls_ssl_free(mbedtls_ssl_context *sslContext)
```

Release any resources that may have been previously allocated by a call to `mbedtls_ssl_init()`.

Includes:

- `mbed/ssl.h`

See also:

- `mbedtls_ssl_init`

## **MBEDTLS\_SSL\_GET\_VERIFY\_RESULT**

### **MBEDTLS\_SSL\_HANDSHAKE**

```
int mbedtls_ssl_handshake(mbedtls_ssl_context *ssl)
```

- `ssl` – The SSL context.

## **MBEDTLS\_SSL\_INIT**

Initialize an SSL context.

```
void mbedtls_ssl_init(mbedtls_ssl_context* sslContext)
```

The data structure is a black box and this function initializes it for us.

Includes:

- `#include <mbed/ssl.h>`

See also:

- `mbedtls_ssl_free`

## **MBEDTLS\_SSL\_READ**

Read data from the context.

```
int mbedtls_ssl_read(  
    mbedtls_ssl_context* sslContext,  
    unsigned char*      buf,  
    size_t              len  
)
```

See also:

- `mbedtls_ssl_write`

## `mbedtls_ssl_session_reset`

Reset an initialized SSL context for re-use.

```
int mbedtls_ssl_session_reset(mbedtls_ssl_context *ssl)
```

- `ssl` – The context to reset.

## `mbedtls_ssl_set_bio`

Identify the functions to be used for sending and receiving data.

```
void mbedtls_ssl_set_bio(
    mbedtls_ssl_context*    context,
    void*                   p_bio,
    mbedtls_ssl_send_t*     f_send,
    mbedtls_ssl_recv_t*     f_recv,
    mbedtls_ssl_recv_timeout_t* f_recv_timeout
)
```

The `context` is the SSL context we are currently using for this communication.

The `p_bio` is a pointer to storage that is passed into the send and receive functions to give them context. This is typically the address of the `mbedtls_net_context` data associated with the peer. This represents the socket file descriptor.

The `f_send` is a function to be called to transmit SSL encrypted data. It can be `mbedtls_net_send`. The signature for this function is:

```
int functionName(void* ctx, const unsigned char* buf, size_t len)
```

The `f_recv` is a function to be called to receive SSL encrypted data. It can be `mbedtls_net_recv`. The signature for this function is:

```
int functionName(void* ctx, unsigned char* buf, size_t len)
```

The `f_recv_timeout` is a function to be called to receive SSL encrypted data with a timeout. It can be `NULL`. The signature of this function is:

```
int functionName(void* ctx, unsigned char* buf, size_t len, uint32_t timeout)
```

See also:

- `mbedtls_net_recv`
- `mbedtls_net_recv_timeout`
- `mbedtls_net_send`

## `mbedtls_ssl_set_hostname`

Set the hostname to check against.

```
int mbedtls_ssl_set_hostname(  
    mbedtls_ssl_context* context,  
    const char*          hostname)
```

Returns 0 on success.

Includes:

- `mbed/ssl.h`

### **mbedtls\_ssl\_setup**

Setup an SSL context for use.

```
int mbedtls_ssl_setup(  
    mbedtls_ssl_context* sslContext,  
    mbedtls_ssl_config*  sslConfig)
```

Includes:

- `mbed/ssl.h`

### **mbedtls\_ssl\_write**

Write a buffer of data down the socket.

```
int mbedtls_ssl_write(  
    mbedtls_ssl_context* ssl,  
    const unsigned char* buf,  
    size_t              len)
```

The number of bytes written or < 0 on error.

Includes:

- `mbed/ssl.h`

See also:

- `mbedtls_ssl_read`

### **mbedtls\_strerror**

```
void mbedtls_strerror(  
    int    errnum,  
    char*  buffer,  
    size_t buflen  
)
```

Convert an error code into a C string representing the error.

We can also print the error code using:

```
printf("-0x%x\n", -errno);
```

Includes:

- `#include <mbed/error.h>`

See also:

- `mbedtls_debug_set_threshold`
- `mbedtls_ssl_conf_dbg`

### **mbedtls\_x509\_crt\_init**

Initialize a certificate chain.

```
void mbedtls_x509_crt_init(mbedtls_x509_crt* crt)
```

### **mbedtls\_x509\_crt\_parse**

Parse one or more certificates and add to the chain.

```
int mbedtls_x509_crt_parse(  
    mbedtls_x509_crt*    chain,  
    const unsigned char* buf,  
    size_t                buflen  
)
```

- `chain` – Pointer to the certification chain.
- `buf` – Buffer holding certificate data in PEM or DER format.
- `len` – Length of the buffer. If we are passing in a PEM then this must **include** the `'\0'` byte at the end.

### **mbedtls\_x509\_crt\_verify\_info**

## **ESP-TLS**

### **esp\_tls\_conn\_delete**

```
void esp_tls_conn_delete(esp_tls_t* tls)
```

Includes:

- `#include <esp_tls.h>`

### **esp\_tls\_conn\_http\_new**

```
esp_tls_t* esp_tls_conn_http_new(  
    const char* url,  
    constesp_tls_cfg_t* cfg)
```

Includes:

- `#include <esp_tls.h>`

### **esp\_tls\_conn\_new**

Create a new TLS connection.

```
esp_tls_t* esp_tls_conn_new(  
    const char* hostname,  
    int hostlen,  
    int port,  
    constesp_tls_cfg_t* cfg)
```

Includes:

- `#include <esp_tls.h>`

### **esp\_tls\_conn\_read**

```
ssize_t esp_tls_conn_read(  
    esp_tls_t* tls,  
    void* data,  
    size_t datalen)
```

Includes:

- `#include <esp_tls.h>`

### **esp\_tls\_conn\_write**

```
ssize_t esp_tls_conn_write(  
    esp_tls_t* tls,  
    const void* data,  
    size_t datalen)
```

Includes:

- `#include <esp_tls.h>`

## Bluetooth LE

See also:

- Bluetooth

### esp\_bt\_uuid\_t

A representation of a UUID.

- `uint16_t len` – The length of the UUID
  - `ESP_UUID_LEN_16` – 16 bits in length.
  - `ESP_UUID_LEN_32` – 32 bits in length.
  - `ESP_UUID_LEN_128` – 128 bits in length.
- union `uuid`
  - `uint16_t uuid16` – Data for a 16 bit uuid.
  - `uuid32_t uuid32` – Data for a 32 bit uuid.
  - `uint8_t uuid128[ESP_UUID_LEN_128]` – Data for a 128 bit uuid.

For the 128 bit UUID, you need to take care that you realize that the data is in little endian format. Putting it another way, the data is Least Significant Byte First.

For example, if your UUID is `12345678-90ab-cdef-1234-567890abcdef`, the you would store this in memory as

```
0xef 0xcd 0xab 0x90 0x78 0x56 0x 34 0x12 0xef 0xcd 0xab 0x90 0x78 0x56 0x34
0x12
```

Includes:

- `#include <esp_gatt_defs.h>`

### esp\_attr\_value\_t

Characteristic value.

- `uint16_t attr_max_len`
- `uint16_t attr_len`
- `uint8_t* attr_value`

### esp\_gatt\_id\_t

The description of a gatt id.



This data type describes a gatt entry.

- `esp_bt_uuid_t uuid` – The UUID of the entry.
- `uint8_t inst_id` – The instance index of this entry.

### `esp_gatt_srv_id_t`

The description of a service.

- `esp_gatt_id_t id` – The identity of the service.
  - `esp_bt_uuid_t uuid` – The UUID of the service.
  - `uint8_t inst_id` – The instance index of this service on the server.
- `bool is_primary` – Is this a primary service?

See also:

- `esp_gatt_id_t`
- `esp_ble_gatts_create_service`

### `esp_gatt_status_t`

The status code for GATT.

- `ESP_GATT_OK`
- `ESP_GATT_INVALID_HANDLE`
- `ESP_GATT_READ_NOT_PERMIT`
- `ESP_GATT_WRITE_NOT_PERMIT`
- `ESP_GATT_INVALID_PDU`
- `ESP_GATT_INSUF_AUTHENTICATION`
- `ESP_GATT_REQ_NOT_SUPPORTED`
- `ESP_GATT_INVALID_OFFSET`
- `ESP_GATT_INSUF_AUTHORIZATION`
- `ESP_GATT_PREPARE_Q_FULL`
- `ESP_GATT_NOT_FOUND`
- `ESP_GATT_NOT_LONG`
- `ESP_GATT_INSUF_KEY_SIZE`

- ESP\_GATT\_INVALID\_ATTR\_LEN
- ESP\_GATT\_ERR\_UNLIKELY
- ESP\_GATT\_INSUF\_ENCRYPTION
- ESP\_GATT\_UNSUPPORT\_GRP\_TYPE
- ESP\_GATT\_INSUF\_RESOURCE
- ESP\_GATT\_NO\_RESOURCES
- ESP\_GATT\_INTERNAL\_ERROR
- ESP\_GATT\_WRONG\_STATE
- ESP\_GATT\_DB\_FULL
- ESP\_GATT\_BUSY
- ESP\_GATT\_ERROR
- ESP\_GATT\_CMD\_STARTED
- ESP\_GATT\_ILLEGAL\_PARAMETER
- ESP\_GATT\_PENDING
- ESP\_GATT\_AUTH\_FAIL
- ESP\_GATT\_MORE
- ESP\_GATT\_INVALID\_CFG
- ESP\_GATT\_SERVICE\_STARTED
- ESP\_GATT\_ENCRYPED\_MITM
- ESP\_GATT\_ENCRYPED\_NO\_MITM
- ESP\_GATT\_NOT\_ENCRYPTED
- ESP\_GATT\_CONGESTED
- ESP\_GATT\_DUP\_REG
- ESP\_GATT\_ALREADY\_OPEN
- ESP\_GATT\_CANCEL
- ESP\_GATT\_STACK\_RSP
- ESP\_GATT\_APP\_RSP
- ESP\_GATT\_UNKNOWN\_ERROR
- ESP\_GATT\_CCC\_CFG\_ERR

- `ESP_GATT_PRC_IN_PROGRESS`
- `ESP_GATT_OUT_OF_RANGE`

### `esp_gattc_char_elem_t`

- `uint16_t char_handle` – The handle for the characteristic.
- `esp_gatt_char_prop_t properties` – The properties of the characteristic.
- `esp_bt_uuid_t uuid` – The UUID of the characteristic.

See also:

- `esp_ble_gattc_get_all_char`

### `esp_gattc_db_elem_t`

- `esp_gatt_db_attr_type_t type` – The type of attribute. One of:
  - `ESP_GATT_DB_PRIMARY_SERVICE`
  - `ESP_GATT_DB_SECONDARY_SERVICE`
  - `ESP_GATT_DB_CHARACTERISTIC`
  - `ESP_GATT_DB_DESCRIPTOR`
  - `ESP_GATT_DB_INCLUDED_SERVICE`
  - `ESP_GATT_DB_ALL`
- `uint16_t attribute_handle` – The attribute handle.
- `uint16_t start_handle` – Service handle start. Only valid when type is `ESP_GATT_DB_PRIMARY_SERVICE` or `ESP_GATT_DB_SECONDARY_SERVICE`.
- `uint16_t end_handle` – Service handle end. Only valid when type is `ESP_GATT_DB_PRIMARY_SERVICE` or `ESP_GATT_DB_SECONDARY_SERVICE`.
- `esp_gatt_char_prop_t properties` – Properties of the entry. Only valid when type is `ESP_GATT_DB_CHARACTERISTIC`.
- `esp_bt_uuid_t uuid` – The UUID of the entry.

### `esp_gattc_descr_elem_t`

- `uint16_t handle` – The handle for the descriptor.

- `esp_bt_uuid_t uuid` – The UUID of the descriptor.

See also:

- `esp_ble_gattc_get_all_descr`

### `esp_gattc_service_elem_t`

The data associated with a given service. We should think of the characteristics of a service as being addressable by *handles*. This structure describes the handles associated with a given service.

- `esp_bt_uuid_t uuid` – The UUID of this service.
- `uint16_t start_handle` – The first handle within the service.
- `uint16_t end_handle` – The last handle within the service.
- `bool is_primary` – Is this a primary service.

See also:

- `esp_ble_gattc_get_service`

### `esp_ble_gap_config_adv_data`

Specify the data that we wish to advertise.

```
esp_err_t esp_ble_gap_config_adv_data(esp_ble_adv_data_t* adv_data)
```

The `adv_data` is a structure including:

- `bool set_scan_rsp` – Set to false to indicate that this is a normal advertisement and set to true to indicate that this is a scan response advertisement.
- `bool include_name`
- `bool include_txpower`
- `int min_interval`
- `int max_interval`
- `int appearance` – Indicate how this advertises device should be presented to the user in terms of appearance. Typically this is used to define the icon that represents the device.
- `uint16_t manufacturer_len`
- `uint8_t* p_manufacturer_data`

- uint16\_t service\_data\_len
- uint8\_t\* p\_service\_data
- uint16\_t service\_uuid\_len – The length of the advertised service UUID array in bytes. Note that this **must** be a multiple of 16. Specify 0 if no service UUID is being advertised.
- uint8\_t\* p\_service\_uuid – Pointer to the storage of the UUIDs being advertised. We can supply multiple UUIDs but they **must** be in 128bit format. Can be NULL if no service UUID is being advertised.
- uint8\_t flag – The flag is a boolean "or" of the following:
  - ESP\_BLE\_ADV\_FLAG\_LIMIT\_DISC – Limited discovery flag.
  - ESP\_BLE\_ADV\_FLAG\_GEN\_DISC – General Discovery flag.
  - ESP\_BLE\_ADV\_FLAG\_BREDR\_NOT\_SPT – Bluetooth standard not supported.
  - ESP\_BLE\_ADV\_FLAG\_DMT\_CONTROLLER\_ST
  - ESP\_BLE\_ADV\_FLAG\_DMT\_HOST\_SPT
  - ESP\_BLE\_ADV\_FLAG\_NON\_LIMIT\_DISC

An example structure might be:

```
static esp_ble_adv_data_t adv_data;
adv_data.set_scan_rsp      = false;
adv_data.include_name     = true;
adv_data.include_txpower  = true;
adv_data.min_interval     = 0x20;
adv_data.max_interval     = 0x40;
adv_data.appearance      = 0x00;
adv_data.manufacturer_len = 0;
adv_data.p_manufacturer_data = NULL;
adv_data.service_data_len = 0;
adv_data.p_service_data   = NULL;
adv_data.service_uuid_len = 0;
adv_data.p_service_uuid   = NULL;
adv_data.flag              = (ESP_BLE_ADV_FLAG_GEN_DISC |
ESP_BLE_ADV_FLAG_BREDR_NOT_SPT);
```

Take special note of the p\_service\_uuid and service\_uuid\_len properties. This is actually an array of services that we are exposing. For 128bit UUIDs, there is no question but for 16bit and 32bit UUIDs we must supply them expanded to their full 128bit values. By this we mean that a 16bit UUID of the form:

XXYY is actually

0000XXYY-0000-1000-8000-00805f9b34fb

and a 32bit UUID of the form AABBCDD is actually

```
AABBCDD-0000-1000-8000-00805f9b34fb
```

Includes:

- `#include <esp_gap_ble_api.h>`

See also:

- Performing advertising
- `esp_ble_gap_start_advertising`
- `esp_ble_gap_stop_advertising`

### **esp\_ble\_gap\_config\_adv\_data\_raw**

Set the data that is to be sent in an advert at the raw level. If this is called, it replaces/over-rides the default advertising data.

```
esp_err_t esp_ble_gap_config_adv_data_raw(  
    uint8_t* rawData,  
    uint32_t len)
```

- `rawData` – The data to be sent in an advert.
- `len` – The length of the data to be sent in an advert. Must be less than or equal to the maximum length of 31 bytes.

### **esp\_ble\_gap\_config\_scan\_rsp\_data\_raw**

Set the data that is to be sent in a scan response at the raw level. If this is called, it replaces/over-rides the default advertising data.

```
esp_err_t esp_ble_gap_config_scan_rsp_data_raw(  
    uint8_t* rawData,  
    uint32_t len  
)
```

- `rawData` – The data to be sent in an advert.
- `len` – The length of the data to be sent in an advert. Must be less than or equal to the maximum length of 31 bytes.

### **esp\_ble\_gap\_config\_local\_privacy**

```
esp_err_t esp_ble_gap_config_local_privacy(bool privacy_enable)
```

Includes:

- `#include <esp_gap_ble_api.h>`

### **esp\_ble\_gap\_disconnect**

```
esp_err_t esp_ble_gap_disconnect(esp_bd_addr_t remote_device)
```

### **esp\_ble\_gap\_get\_whitelist\_size**

```
esp_err_t esp_ble_gap_get_whitelist_size(uint16_t *length)
```

### **esp\_ble\_gap\_read\_rssi**

```
esp_err_t esp_ble_gap_read_rssi(esp_bd_addr_t remote_addr)
```

Invoking this function results in an eventual GAP event of

`ESP_GAP_BLE_READ_RSSI_COMPLETE_EVT`.

See also:

- `ESP_GAP_BLE_READ_RSSI_COMPLETE_EVT`

### **esp\_ble\_gap\_register\_callback**

Register a callback for gap events.

```
esp_err_t esp_ble_gap_register_callback(esp_profile_cb_t callback)
```

While not explicitly stated it is assumed that the ESP-IDF maintains knowledge of just a single callback. Thus if you want multiple functions to be invoked on an event, you would be responsible for implementing a mediator using your own logic.

The `esp_profile_cb_t` is a C function with the following signature:

```
void func(esp_gap_ble_cb_event_t event, esp_ble_gap_cb_param_t *param)
```

The `param` is an an instance of a pointer to an `esp_ble_gap_cb_param_t`.

Event types include:

#### `ESP_GAP_BLE_ADD_WHITELIST_COMPLETE_EVT`

Called when a whitelist entry has been added. Structure parameter is called `add_whitelist_cmpl`.

- `esp_bt_status_t` status
- `esp_ble_wl_operation` wl\_operation
  - `ESP_BLE_WHITELIST_REMOVE`
  - `ESP_BLE_WHITELIST_ADD`

See also:

- `esp_ble_gap_update_whitelist`

#### ESP\_GAP\_BLE\_ADV\_DATA\_SET\_COMPLETE\_EVT

Called when advertising data set is complete. Structure parameter is called `adv_data_cmpl`.

- `esp_bt_status_t` status

#### ESP\_GAP\_BLE\_ADV\_DATA\_RAW\_SET\_COMPLETE\_EVT

Structure parameter is called `adv_data_raw_cmpl`.

- `esp_bt_status_t` status

#### ESP\_GAP\_BLE\_ADV\_START\_COMPLETE\_EVT

Structure parameter is called `adv_start_cmpl`.

- `esp_bt_status_t` status

See also:

- `esp_ble_gap_start_scanning`

#### ESP\_GAP\_BLE\_ADV\_STOP\_COMPLETE\_EVT

On receipt, the param field called `adv_stop_cmpl` is populated, This is a structure which contains:

- `esp_bt_status_t` status

#### ESP\_GAP\_BLE\_AUTH\_CMPL\_EVT

On receipt, the `param` field called `ble_security` is populated which is itself a union. The field called `auth_cmpl` within it is populated:

- `esp_bd_addr_t` `bd_addr`
- `bool` `key_present`
- `esp_link_key` `key`
- `uint8_t` `key_type`
- `bool` `success`
- `uint8_t` `fail_reason`



- esp\_bd\_addr\_type\_t addr\_type
- esp\_bt\_dev\_type\_t dev\_type

#### ESP\_GAP\_BLE\_CLEAR\_BOND\_DEV\_COMPLETE\_EVT

On receipt, the param filed called `clear_bond_dev_cmpl` is populated:

- esp\_bt\_status\_t status

#### ESP\_GAP\_BLE\_GET\_BOND\_DEV\_COMPLETE\_EVT

#### ESP\_GAP\_BLE\_KEY\_EVT

#### ESP\_GAP\_BLE\_LOCAL\_ER\_EVT

#### ESP\_GAP\_BLE\_LOCAL\_IR\_EVT

#### ESP\_GAP\_BLE\_NC\_REQ\_EVT

Numeric comparison request.

The parameter passed in the event is an instance of `esp_ble_sec_t` called `ble_security`. This is itself a union and the populated field is `key_notif`.

- esp\_ble\_sec\_key\_notif\_t key\_notif
  - esp\_bd\_addr\_t bd\_addr
  - uint32\_t passkey

#### ESP\_GAP\_BLE\_OOB\_REQ\_EVT

#### ESP\_GAP\_BLE\_PASSKEY\_NOTIF\_EVT

## ESP\_GAP\_BLE\_PASSKEY\_REQ\_EVT

### ESP\_GAP\_BLE\_READ\_RSSI\_COMPLETE\_EVT

Structure parameter is called `read_rssi_cmpl`.

- `esp_bt_status_t` status
- `int8_t` rssi
- `esp_bd_addr_t` remote\_addr

See also:

- `esp_ble_gap_read_rssi`

### ESP\_GAP\_BLE\_REMOVE\_BOND\_DEV\_COMPLETE\_EVT

On receipt, the param filed called `remove_bond_dev_cmpl` is populated:

- `esp_bt_status_t` status

### ESP\_GAP\_BLE\_SCAN\_PARAM\_SET\_COMPLETE\_EVT

Called when scan parameters set complete. Structure parameter is called `scan_param_cmpl`.

- `esp_bt_status_t` status

See also:

- Error: Reference source not found

### ESP\_GAP\_BLE\_SCAN\_RESULT\_EVT

The parameter is an instance of `esp_ble_gap_cb_param_t`. Called when one scan result is ready. Structure parameter is called `scan_rst`.

- `esp_gap_search_evt_t` search\_evt – Choices are
  - `ESP_GAP_SEARCH_INQ_RES_EVT` – We have received a search result.
  - `ESP_GAP_SEARCH_INQ_CMPL_EVT` – The search is complete.
  - `ESP_GAP_SEARCH_DISC_RES_EVT`
  - `ESP_GAP_SEARCH_DISC_BLE_RES_EVT`
  - `ESP_GAP_SEARCH_DISC_CMPL_EVT`
  - `ESP_GAP_SEARCH_DI_DISC_CMPL_EVT`

- ESP\_GAP\_SEARCH\_SEARCH\_CANCEL\_CMPL\_EVT
  - esp\_bd\_addr\_t bda – The address of the device. 6 bytes of data.
  - esp\_bt\_dev\_type\_t dev\_type – One of:
    - ESP\_BT\_DEVICE\_TYPE\_BREDR
    - ESP\_BT\_DEVICE\_TYPE\_BLE
    - ESP\_BT\_DEVICE\_TYPE\_DUMO
  - esp\_ble\_addr\_type\_t ble\_addr\_type – One of
    - BLE\_ADDR\_TYPE\_PUBLIC
    - BLE\_ADDR\_TYPE\_RANDOM
    - BLE\_ADDR\_TYPE\_RPA\_PUBLIC
    - BLE\_ADDR\_TYPE\_RPA\_RANDOM
  - esp\_ble\_evt\_type\_t ble\_evt\_type – One of
    - ESP\_BLE\_EVT\_CONN\_ADV
    - ESP\_BLE\_EVT\_CONN\_DIR\_ADV
    - ESP\_BLE\_EVT\_DISC\_ADV
    - ESP\_BLE\_EVT\_NON\_CONN\_ADV
    - ESP\_BLE\_EVT\_SCAN\_RSP
  - int rssi – The signal strength.
  - uint8\_t ble\_adv[ESP\_BLE\_ADV\_DATA\_LEN\_MAX]
  - int flag
  - int num\_resps
  - uint8\_t adv\_data\_len
  - uint8\_t scan\_rsp\_len
- ESP\_GAP\_BLE\_SCAN\_RSP\_DATA\_SET\_COMPLETE\_EVT – Called when the scan response data set is complete. Structure parameter is called scan\_rsp\_data\_cmpl.
    - esp\_bt\_status\_t status

#### ESP\_GAP\_BLE\_SCAN\_RSP\_DATA\_RAW\_SET\_COMPLETE\_EVT

The parameter contains `scan_rsp_data_raw_cmpl`. It contains:

- `esp_bt_status_t status` – The status of the event.

#### ESP\_GAP\_BLE\_SCAN\_RSP\_DATA\_SET\_COMPLETE\_EVT

The parameter contains `scan_rsp_data_cmpl`. It contains:

- `esp_bt_status_t status` – The status of the event.

#### ESP\_GAP\_BLE\_SCAN\_START\_COMPLETE\_EVT

The parameter contains `scan_start_cmpl`. It contains:

- `esp_bt_status_t status` – The status of the event.

#### ESP\_GAP\_BLE\_SCAN\_STOP\_COMPLETE\_EVT

The structure associated with this event is `struct ble_scan_stop_cmpl_evt_param` found in the field called `scan_stop_cmpl`. It contains:

- `esp_bt_status_t status` – The status of the event.

#### ESP\_GAP\_BLE\_SEC\_REQ\_EVT

BLE Security request.

The parameter passed in the event is an instance of `esp_ble_sec_t` called `ble_security`. This is itself a union and the populated field is `ble_req`. It is expected that a call to `esp_ble_gap_security_rsp()` will be made on receipt.

A union of:

- `esp_ble_sec_key_notif_t key_notif`
  - `esp_bd_addr_t bd_addr`
  - `uint32_t passkey`
- `esp_ble_sec_req_t ble_req`
  - `esp_bd_addr_t bd_addr`
- `esp_ble_key_t ble_key`

- esp\_bd\_addr\_t bd\_addr
- esp\_ble\_key\_type\_t key\_type
- esp\_ble\_key\_value\_t p\_key\_value
- esp\_ble\_local\_id\_keys\_t ble\_id\_keys
  - esp\_bt\_octet16\_t ir
  - esp\_bt\_octet16\_t irk
  - esp\_bt\_octet16\_t dhk
- esp\_ble\_auth\_cmpl\_t auth\_cmpl
  - esp\_bd\_addr\_t bd\_addr
  - bool key\_present
  - esp\_link\_key key
  - uint8\_t key\_type
  - bool success
  - uint8\_t fail\_reason
  - esp\_ble\_addr\_type\_t addr\_type
  - esp\_bt\_dev\_type\_t dev\_type

Includes:

- #include <esp\_gap\_ble\_api.h>

See also:

ESP\_GAP\_BLE\_SET\_LOCAL\_PRIVACY\_COMPLETE\_EVT

ESP\_GAP\_BLE\_SET\_PKT\_LENGTH\_COMPLETE\_EVT

ESP\_GAP\_BLE\_SET\_STATIC\_RAND\_ADDR\_EVT

ESP\_GAP\_BLE\_UPDATE\_CONN\_PARAMS\_EVT

Parameter contains `update_conn_params`. This contains:

- esp\_bt\_status\_t status

- `esp_bd_addr_t bda`
- `uint16_t min_int`
- `uint16_t max_int`
- `uint16_t latency`
- `uint16_t conn_int`
- `uint16_t timeout`

### **esp\_ble\_gap\_security\_rsp**

Respond to a secure request.

```
esp_err_t esp_ble_gap_security_rsp(esp_bd_addr_t bd_addr, bool accept)
```

- `bd_addr` – The address of the peer.
- `accept` – True to accept the request and false to reject.

See also:

- `ESP_GAP_BLE_SEC_REQ_EVT`

### **esp\_ble\_gap\_set\_device\_name**

Set the name of the device as it will appear in advertising. In addition this appears under the service 0x1800 under characteristic 0x2a00 – Device Name.

```
esp_err_t esp_ble_gap_set_device_name(const char* name)
```

Includes:

- `#include <esp_gap_ble_api.h>`

### **esp\_ble\_set\_encryption**

```
esp_err_t esp_ble_set_encryption(
    esp_bd_addr_t bd_addr,
    esp_ble_sec_act_t sec_act
)
```

- `bd_addr`
- `sec_act`
  - `ESP_BLE_SEC_NONE`
  - `ESP_BLE_SEC_ENCRYPT`

- ESP\_BLE\_SEC\_ENCRYPT\_NO\_MITM
- ESP\_BLE\_SEC\_ENCRYPT\_MITM

### esp\_ble\_gap\_set\_pkt\_data\_len

```
esp_err_t esp_ble_gap_set_pkt_data_len(
    esp_bd_addr_t remote_device,
    uint16_t tx_data_length)
```

Includes:

- #include <esp\_gap\_ble\_api.h>

### esp\_ble\_gap\_set\_prefer\_conn\_params

```
esp_err_t esp_ble_gap_set_prefer_conn_params(
    esp_bd_addr_t bd_addr,
    uint16_t min_conn_int,
    uint16_t max_conn_int,
    uint16_t slave_latency,
    uint16_t supervision_tout)
```

### esp\_ble\_gap\_set\_rand\_addr

```
esp_err_t esp_ble_gap_set_rand_addr(esp_bd_addr_t rand_addr)
```

Includes:

- #include <esp\_gap\_ble\_api.h>

### esp\_ble\_gap\_set\_security\_param

```
esp_err_t esp_ble_gap_set_security_param(
    esp_ble_sm_param_t param_type,
    void* value,
    uint8_t len
)
```

- param\_type – The type of parameter to set.
  - ESP\_BLE\_SM\_PASSKEY
  - ESP\_BLE\_SM\_AUTHEN\_REQ\_MODE
  - ESP\_BLE\_SM\_IOCAP\_MODE – Does the device have input/output capability? The value parameter would be an instance of `esp_ble_io_cap_t`. Values of this are:

- ESP\_IO\_CAP\_OUT – Display only.
- ESP\_IO\_CAP\_IO – Keyboard and display.
- ESP\_IO\_CAP\_IN – Keyboard input only.
- ESP\_IO\_CAP\_NONE – No input and no output.
- ESP\_IO\_CAP\_KBDISP – Keyboard display.
- ESP\_BLE\_SM\_SET\_INIT\_KEY
- ESP\_BLE\_SM\_SET\_RSP\_KEY
- ESP\_BLE\_SM\_MAX\_KEY\_SIZE
- value – The value of the parameter.
- len – The length of the parameter.

For example:

```
esp_ble_io_cap_t iocap = ESP_IO_CAP_NONE;
esp_ble_gap_set_security_param(ESP_BLE_SM_IOCAP_MODE, &iocap, sizeof(uint8_t));
```

### esp\_ble\_gap\_set\_scan\_params

Set the parameters for a subsequent BLE scan.

```
esp_err_t esp_ble_gap_set_scan_params(esp_ble_scan_params_t *scan_params)
```

- esp\_ble\_scan\_type\_t scan\_type – Scan type. One of:
  - BLE\_SCAN\_TYPE\_PASSIVE – Perform a passive scan where no scan response is requested from the advertiser.
  - BLE\_SCAN\_TYPE\_ACTIVE – Perform an active scan where a scan response is requested from the advertiser.
- esp\_ble\_addr\_type\_t own\_addr\_type – Own address type. One of:
  - BLE\_ADDR\_TYPE\_PUBLIC
  - BLE\_ADDR\_TYPE\_RANDOM
  - BLE\_ADDR\_TYPE\_RPA\_PUBLIC
  - BLE\_ADDR\_TYPE\_RPA\_RANDOM
- esp\_ble\_scan\_filter\_t scan\_filter\_policy – Filter policy. One of:
  - BLE\_SCAN\_FILTER\_ALLOW\_ALL
  - BLE\_SCAN\_FILTER\_ALLOW\_ONLY\_WLST



- BLE\_SCAN\_FILTER\_ALLOW\_UND\_RPA\_DIR
- BLE\_SCAN\_FILTER\_ALLOW\_WLIST\_PRA\_DIR
- `uint16_t scan_interval` – Interval between scans. Value is multiplied by 0.625 msecs.
- `uint16_t scan_window` – Duration of the scan. Must be less than or equal to the `scan_interval`.

Includes:

- `#include <esp_gap_ble_api.h>`

See also:

- `esp_ble_resolve_adv_data`
- `esp_ble_gap_start_scanning`
- `esp_ble_gap_stop_scanning`
- `ESP_GAP_BLE_SCAN_PARAM_SET_COMPLETE_EVT`

### **esp\_ble\_gap\_start\_advertising**

Start GAP protocol advertising.

```
esp_err_t esp_ble_gap_start_advertising(esp_ble_adv_params_t* adv_params)
```

We can stop GAP protocol advertising by calling `esp_ble_gap_stop_advertising()`.

The `adv_params` structure contains the following:

- `uint16_t adv_int_min`
- `uint16_t adv_int_max`
- `esp_ble_adv_type_t adv_type` – One of:
  - `ADV_TYPE_IND` – Un-directed connectable mode (ADV\_IND)
  - `ADV_TYPE_DIRECT_IND_HIGH`
  - `ADV_TYPE_DIRECT_IND_LOW`
  - `ADV_TYPE_NONCONN_IND` – Non-connectable (ADV\_NONCONN\_IND)
  - `ADV_TYPE_SCAN_IND` – Non-connectable but scan response available (ADV\_SCAN\_IND)
- `esp_ble_addr_type_t own_addr_type` – One of
  - `BLE_ADDR_TYPE_PUBLIC`
  - `BLE_ADDR_TYPE_RANDOM`

- BLE\_ADDR\_TYPE\_RPA\_PUBLIC
  - BLE\_ADDR\_TYPE\_RPA\_RANDOM
- esp\_bd\_addr\_t peer\_addr
- esp\_ble\_addr\_type\_t peer\_addr\_type – One of
  - BLE\_ADDR\_TYPE\_PUBLIC
  - BLE\_ADDR\_TYPE\_RANDOM
  - BLE\_ADDR\_TYPE\_RPA\_PUBLIC
  - BLE\_ADDR\_TYPE\_RPA\_RANDOM
- esp\_ble\_adv\_channel\_t channel\_map – One of:
  - ADV\_CHNL\_37
  - ADV\_CHNL\_38
  - ADV\_CHNL\_39
  - ADV\_CHNL\_ALL
- esp\_ble\_adv\_filter\_t adv\_filter\_policy – One of:
  - ADV\_FILTER\_ALLOW\_SCAN\_ANY\_CON\_ANY – Allow scan request processing and connections from anyone.
  - ADV\_FILTER\_ALLOW\_SCAN\_WLST\_CON\_ANY – Scan request processing only from those on the white list but connection from anyone.
  - ADV\_FILTER\_ALLOW\_SCAN\_ANY\_CON\_WLST – Allow scan request processing from anyone but connections only from those on the white list.
  - ADV\_FILTER\_ALLOW\_SCAN\_WLST\_CON\_WLST – Allow ONLY scan request processing and connection from those on the white list.

An example structure might be:

```
esp_ble_adv_params_t adv_params;
adv_params.adv_int_min      = 0x20;
adv_params.adv_int_max     = 0x40;
adv_params.adv_type        = ADV_TYPE_IND;
adv_params.own_addr_type   = BLE_ADDR_TYPE_PUBLIC;
adv_params.channel_map     = ADV_CHNL_ALL;
adv_params.adv_filter_policy = ADV_FILTER_ALLOW_SCAN_ANY_CON_ANY;
```

Includes:

- #include <esp\_gap\_ble\_api.h>

See also:

- Performing advertising
- esp\_ble\_gap\_stop\_advertising
- esp\_ble\_gap\_config\_adv\_data
- esp\_ble\_gap\_register\_callback

### esp\_ble\_gap\_start\_scanning

Start scanning for arriving advertising packets.

```
esp_err_t esp_ble_gap_start_scanning(uint32_t duration)
```

The duration is how long we are to perform scanning and is measured in seconds. A duration of 0 means scan indefinitely.

Includes:

- `#include <esp_gap_ble_api.h>`

See also:

- Error: Reference source not found
- esp\_ble\_gap\_stop\_scanning

### esp\_ble\_gap\_stop\_advertising

Stop advertising.

```
esp_err_t esp_ble_gap_stop_advertising(void)
```

Includes:

- `#include <esp_gap_ble_api.h>`

### esp\_ble\_gap\_stop\_scanning

Stop the current in progress scanning looking for advertising packets.

```
esp_err_t esp_ble_gap_stop_scanning(void)
```

Includes:

- `#include <esp_gap_ble_api.h>`

See also:

- esp\_ble\_gap\_start\_scanning

## **esp\_ble\_gap\_update\_conn\_params**

`esp_err_t esp_ble_gap_update_conn_params(esp_ble_conn_update_params_t* params)`

The `esp_ble_conn_update_params_t` contains:

- `esp_bd_addr_t bda`
- `uint16_t min_int` – Minimum connection interval.
- `uint16_t max_int` – maximum connection interval.
- `uint16_t latency` – Slave latency.
- `uint16_t timeout` – Timeout in 10 msec units. Range is 0x0a to 0xc80 (100msecs to 32 seconds).

Includes:

- `#include <esp_gap_ble_api.h>`

## **esp\_ble\_gap\_update\_whitelist**

Update the BLE white list for this BLE device.

`esp_err_t esp_ble_gap_update_whitelist(bool add_remove, esp_bd_addr_t remoteBda)`

- `add_remove` – true to add the address to the white list and false to remove it.
- `remoteBda` – The address to add/remove from the white list.

See also:

- `ESP_GAP_BLE_ADD_WHITELIST_COMPLETE_EVT`

## **esp\_ble\_gattc\_app\_register**

Register application.

`esp_err_t esp_ble_gattc_app_register(uint16_t app_id)`

The `app_id` is the identity of an application. This can be any numeric smaller than 0x7fff.

Includes:

- `#include <esp_gattc_api.h>`

See also:

- `ESP_GATTC_REG_EVT`

### **esp\_ble\_gattc\_app\_unregister**

```
esp_err_t esp_ble_gattc_app_unregister(esp_gatt_if_t gatt_if)
```

Includes:

- `#include <esp_gattc_api.h>`

### **esp\_ble\_gattc\_close**

Close a previously opened connection.

```
esp_err_t esp_ble_gattc_close(  
    esp_gatt_if_t gattc_if,  
    uint16_t      conn_id)
```

Includes:

- `#include <esp_gattc_api.h>`

See also:

- `esp_ble_gattc_open`

### **esp\_ble\_gattc\_cache\_refresh**

```
esp_err_t esp_ble_gattc_cache_refresh(esp_bd_addr_t remote_bda)
```

### **esp\_ble\_gattc\_config\_mtu**

```
esp_err_t esp_ble_gattc_config_mtu(  
    uint16_t conn_id,  
    uint16_t mtu)
```

Includes:

- `#include <esp_gattc_api.h>`

### **esp\_ble\_gattc\_execute\_write**

```
esp_err_t esp_ble_gattc_execute_write(  
    esp_gattc_if_t gattc_if,  
    uint16_t      conn_id,  
    bool          is_execute)
```

- `gattc_if`

- conn\_id
- is\_execute

Includes:

- #include <esp\_gattc\_api.h>

### esp\_ble\_gattc\_get\_all\_char

Find all the characteristics with the given service in the GATT cache.

```
esp_gatt_status_t esp_ble_gattc_get_all_char(
    esp_gatt_if_t      gattc_if,
    uint16_t           conn_id,
    uint16_t           start_handle,
    uint16_t           end_handle,
    esp_gattc_char_elem_t* result,
    uint16_t*          count,
    uint16_t           offset
)
```

Think of a service as having a range of handles. Each of these handles is a reference to some record held on the BLE server. The record types can be the service itself, a characteristic or a descriptor. When called, this function will retrieve the characteristics of the service. In order to get this information, we need to provide some help to the function. First of all we need to provide the start and end handles associated with the service. This will bracket the retrieval for only characteristics associated with that service.

It is our responsibility to provide storage into which the characteristic data associated with the service will be stored on return from the call. Before this call, we might not know how many characteristics the service has. We can find out that answer by making a call to `esp_ble_gattc_get_attr_count()`. This gives us the option of pre-allocating a buffer large enough for all the characteristics.

An alternative design would be to iterate through each of the characteristics of the service one at a time. In that scenario, we wouldn't need to provide storage for all the characteristics. Instead, we could provide storage for just one characteristic and loop over each of them. This design pattern is also supported by using the offset mechanism. The first characteristic is known as offset 0, the second as offset 1 and so on. If we ask for a characteristic beyond the available set of characteristics, when we make the call we are returned the status value of `ESP_GATT_INVALID_OFFSET` which indicates to us that we have read all the characteristics.

- gattc\_if – GATT client access interface.
- conn\_id – Connection id identifying the server.

- `start_handle` – The characteristic start handle.
- `end_handle` – The characteristic end handle.
- `result` – Results. The storage into which the characteristic data will be written. The number of elements in this storage must be passed in with the `count` parameter. An element of this type contains:
  - `uint16_t char_handle` – The handle for the characteristic.
  - `esp_gatt_char_prop_t properties` – The properties of the characteristic.
  - `esp_bt_uuid uuid` – The UUID of the characteristic.
- `count` – Count of results. On input, this is the number of elements in the result buffer and on out, the number of elements filled in.
- `offset` – Offset. The offset into the characteristic entries held on the server. We would specify 0 if we are retrieving all of the characteristics because we have allocated enough storage or we would specify the index of the next characteristic we wish if we are iterating over the values.

See also:

- `esp_gattc_char_elem_t`

### `esp_ble_gattc_get_all_descr`

```
esp_gatt_status_t esp_ble_gattc_get_all_descr(
    uint16_t          conn_id,
    esp_gatt_if_t     gattc_if,
    uint16_t          char_handle,
    esp_gattc_descr_elem_t* result,
    uint16_t*         count,
    uint16_t          offset
)
```

- `gattc_if` – GATT client access interface.
- `conn_id` – Connection id identifying the server.
- `start_handle` – The descriptor start handle.
- `end_handle` – The descriptor end handle.
- `result` – Results.
- `count` – Count of results.
- `offset` – Offset.

## esp\_ble\_gattc\_get\_attr\_count

Obtains the number of handles of a certain type in a certain handle range.

```
esp_gatt_status_t esp_ble_gattc_get_attr_count(  
    esp_gatt_if_t          gattc_if,  
    uint16_t              conn_id,  
    esp_gatt_db_attr_type_t type,  
    uint16_t              start_handle,  
    uint16_t              end_handle,  
    uint16_t              char_handle,  
    uint16_t*             count  
)
```

- `gattc_if` – The GATT client access interface.
- `conn_id` – The connection ID which identifies the server.
- `type` – The attribute type.
  - `ESP_GATT_DB_PRIMARY_SERVICE`
  - `ESP_GATT_DB_SECONDARY_SERVICE`
  - `ESP_GATT_DB_CHARACTERISTIC`
  - `ESP_GATT_DB_DESCRIPTOR`
  - `ESP_GATT_DB_INCLUDED_SERVICE`
  - `ESP_GATT_DB_ALL`
- `start_handle` – The start handle. Not used for type `ESP_GATT_DB_DESCRIPTOR`.
- `end_handle` – The end handle. Not used for type `ESP_GATT_DB_DESCRIPTOR`.
- `char_handle` – The characteristic handle. Only used when the type is `ESP_GATT_DB_DESCRIPTOR`.
- `count` – The number of attributes found.

## esp\_ble\_gattc\_get\_char\_by\_uuid

Find a given characteristic from its UUID value.

```
esp_gatt_status_t esp_ble_get_char_by_uuid(  
    esp_gatt_if_t          gattc_if,  
    uint16_t              conn_id,  
    uint16_t              start_handle,  
    uint16_t              end_handle,
```



```

    esp_bt_uuid_t          char_uuid,
    esp_gattc_char_elem_t* result,
    uint16_t*             count
)

```

- `gattc_if` – The GATT client access interface.
- `conn_id` – The connection ID used to identify the server.
- `start_handle` – The characteristic start handle.
- `end_handle` – The characteristic end handle.
- `char_uuid` – The characteristic UUID.
- `result` – Characteristic within the service.
- `count` – The number of returned items.

See also:

- `esp_gattc_char_elem_t`

## esp\_ble\_gattc\_get\_characteristic

**Warning: Removed in ESP-IDF 3.0**

Ask the BLE partner to return a characteristic.

```

esp_err_t esp_ble_gattc_get_characteristic(
    esp_gatt_if_t          gattc_if,
    uint16_t              conn_id,
    esp_gatt_srv_id_t*    srv_id,
    esp_gatt_id_t*        last_characteristic_id)

```

When this call is made a request is sent to the GATT server to return the "next" characteristic. We should imagine that a GATT service has a set of 0 or more characteristics that it maintains in some form of internal order. The numeric order is not important, only that there is the concept of a "next" and "no more". When we call this function with `last_characteristic_id` set to NULL then we are saying "get me the first characteristic". If we subsequently call the function again passing in the id of the last characteristic returned, we will get the next characteristic. When we reach the end of the characteristics, the status code in the returned event will no longer be ok.

This call is a request only and the response will come asynchronously as an `ESP_GATTC_GET_CHAR_EVT` event.

The `conn_id` is the identity of a connection to the server.

The `srvc_id` is the identity of a service on the GATT server. This can be obtained by performing a search request against the server and the `esp_gatt_srvc_id_t` is returned in an `ESP_GATTC_SEARCH_RES_EVT` callback.

The `last_characteristic_id` can be NULL to get the first characteristic. Since we are iterating through characteristics, there must be a way to learn that there are no more. This is determined because we get a status value of `ESP_GATT_ERROR` for the `ESP_GATTC_GET_CHAR_EVT` event.

Includes:

- `#include <esp_gattc_api.h>`

See also:

- `ESP_GATTC_SEARCH_RES_EVT`
- `ESP_GATTC_GET_CHAR_EVT`
- `esp_ble_gattc_search_service`

### `esp_ble_gattc_get_db`

```
esp_gatt_status_t esp_ble_gattc_get_db(  
    esp_gatt_if_t      gattc_if,  
    uint16_t          conn_id,  
    uint16_t          start_handle,  
    uint16_t          end_handle,  
    esp_gattc_db_elem_t* db,  
    uint16_t*         count  
)
```

- `gattc_if` – The client access interface.
- `conn_id` – The connection ID to the server.
- `start_handle` – The start handle.
- `end_handle` – The end handle.
- `db` – A pointer to DB data. The caller is responsible for calling `free()` to release it.
- `count` – The number of elements returned.

See also:

- `esp_gattc_db_elem_t`

### `esp_ble_gattc_get_descr_by_char_handle`

Find a descriptor handle given a characteristic handle and a descriptor UUID.

```

esp_gatt_status_t esp_ble_gattc_get_descr_by_char_handle(
    esp_gatt_if_t      gattc_if,
    uint16_t           conn_id,
    uint16_t           char_handle,
    esp_bt_uuid_t      descr_uuid,
    esp_gattc_descr_elem_t* result,
    uint16_t*          count
)

```

- `gattc_if` – The GATT client access interface.
- `conn_id` – The connection ID that identifies the server.
- `char_handle` – The characteristic handle to be used as a key.
- `descr_uuid` – The UUID of the descriptor.
- `result` – The result. This contains.
  - `uint16_t handle` – The handle for the descriptor.
  - `esp_bt_uuid_t uuid` – The UUID of the descriptor.
- `count` – The count of results.

### **esp\_ble\_gattc\_get\_descr\_by\_uuid**

Determine the descriptor handle from a handle range, a characteristic UUID and the descriptor UUID.

```

esp_gatt_status_t esp_ble_gattc_get_descr_by_uuid(
    esp_gatt_if_t      gattc_if,
    uint16_t           conn_id,
    uint16_t           start_handle,
    uint16_t           end_handle,
    esp_bt_uuid_t      char_uuid,
    esp_bt_uuid_t      descr_uuid,
    esp_gattc_descr_elem_t* result,
    uint16_t*          count
)

```

- `gattc_if` – The GATT client access interface.
- `conn_id` – The connection ID identifying the server.
- `start_handle` – The start handle.
- `end_handle` – The end handle.
- `char_uuid` – The characteristic UUID containing the sought descriptor.
- `descr_uuid` – The descriptor UUID.

- `result` – The result.
- `count` – The number of results.

See also:

- `esp_gattc_descr_elem_t`

### `esp_ble_gattc_get_descriptor`

```
esp_err_t esp_ble_gattc_get_descriptor(
    esp_gatt_if_t      gattc_if,
    uint16_t           conn_id,
    esp_gatt_srvc_id_t* srvc_id,
    esp_gatt_id_t*     characteristic_id,
    esp_gatt_id_t*     start_descriptor_id)
```

The `start_descriptor_id` can be NULL to get the first descriptor.

Includes:

- `#include <esp_gattc_api.h>`

### `esp_ble_gattc_get_include_service`

```
esp_gatt_status_t esp_ble_gattc_get_include_service(
    esp_gatt_if_t      gattc_if,
    uint16_t           conn_id,
    uint16_t           start_handle,
    uint16_t           end_handle,
    esp_bt_uuid_t*     incl_uuid,
    esp_gattc_incl_svc_elem_t* result,
    uint16_t*          count
)
```

- `gattc_if` – The GATT client access interface.
- `conn_id` – The connection ID which identifies the server.
- `start_handle` – The start handle.
- `end_handle` – The end handle.
- `incl_uuid` – The included service UUID.
- `result` – The result.
- `count` – The count of results.

### `esp_ble_gattc_get_included_service`

**Warning: Removed in ESP-IDF 3.0**

```

esp_err_t esp_ble_gattc_get_included_service(
    esp_gatt_if_t      gattc_if,
    uint16_t           conn_id,
    esp_gatt_srvc_id_t* srvc_id,
    esp_gatt_srvc_id_t* start_incl_srvc_id)

```

Includes:

- `#include <esp_gattc_api.h>`

### `esp_ble_gattc_get_service`

Retrieve the handles that are associated with a service.

```

esp_gatt_status_t esp_ble_gattc_get_service(
    esp_gatt_if_t      gattc_if,
    uint16_t           conn_id,
    esp_bt_uuid_t*     svc_uuid,
    esp_gattc_service_elem_t* result,
    uint16_t*          count,
    uint16_t           offset
)

```

It is important to note that this call will **not** reach out to the BLE server to learn about it. Instead, the data returned comes from a local cache maintained by the ESP-IDF BLE client library. If we need to query the BLE server directly, makes calls to

`esp_ble_gattc_search_service`.

- `gattc_if` – The GATT client access interface.
- `conn_id` – The connection id used to identify the server.
- `svc_uuid` – The Service ID sought. Can be NULL to get all the services.
- `result` – A pointer to the structure describing the service.
- `count` – On input, the number of items that can be stored in the buffer; On output, the count of elements actually written.
- `offset` – Unknown

See also:

- `esp_gattc_service_elem_t`
- `esp_ble_gattc_search_service`

### `esp_ble_gattc_open`

Open a connection to the GATT server.

```
esp_err_t esp_ble_gattc_open(  
    esp_gatt_if_t gatt_if,  
    esp_bd_addr_t remote_bda,  
    bool          is_direct)
```

The `gatt_if` is the application client interface. The initial is `ESP_GATT_IF_NONE`. We must store the `gattc_if` when we receive the first `ESP_GATTC_REG_EVT`.

The `remote_bda` is the bluetooth device address to which we wish to connect.

If `is_direct` then we are asking for a direct connection otherwise a background auto connection.

Includes:

- `#include <esp_gattc_api.h>`

See also:

- `esp_ble_gattc_close`
- `ESP_GATTC_REG_EVT`
- `ESP_GATTC_OPEN_EVT`
- `ESP_GATTC_CLOSE_EVT`

### `esp_ble_gattc_prepare_write`

**Warning: Changed in ESP-IDF 3.0**

```
esp_err_t esp_ble_gattc_prepare_write(  
    esp_gattc_if_t    gattc_if,  
    uint16_t          conn_id,  
    uint16_t          handle,  
    uint16_t          offset,  
    uint16_t          value_len,  
    uint8_t*          value,  
    esp_gatt_auth_req_t auth_req)
```

- `gattc_if`
- `conn_id`
- `handle`
- `offset`
- `value_len`
- `value`
- `auth_req`

Includes:

- `#include <esp_gattc_api.h>`

## esp\_ble\_gattc\_prepare\_write\_char\_descr

```
esp_err_t esp_ble_gattc_prepare_write_char_descr(  
    esp_gatt_if_t      gattc_if,  
    uint16_t          conn_id,  
    uint16_t          handle,  
    uint16_t          offset,  
    uint16_t          value_len,  
    uint8_t*          value,  
    esp_gatt_auth_req_t auth_req  
)
```

## esp\_ble\_gattc\_read\_char

**Warning: Changes in ESP-IDF 3.0**

Read the value of a characteristic.

```
esp_err_t esp_ble_gattc_read_char(  
    esp_gatt_if_t      gattc_if,  
    uint16_t          conn_id,  
    uint16_t          handle,  
    esp_gatt_auth_req_t auth_req)
```

The handle is used to identify which characteristic to read.

The `auth_req` is one of:

- ESP\_GATT\_AUTH\_REQ\_NONE
- ESP\_GATT\_AUTH\_REQ\_NO\_MITM
- ESP\_GATT\_AUTH\_REQ\_MITM
- ESP\_GATT\_AUTH\_REQ\_SIGNED\_NO\_MITM
- ESP\_GATT\_AUTH\_REQ\_SIGNED\_MITM

Includes:

- `#include <esp_gattc_api.h>`

See also:

- ESP\_GATTC\_READ\_CHAR\_EVT

## esp\_ble\_gattc\_read\_char\_descr

**Warning: Changed in ESP-IDF 3.0**

```
esp_err_t esp_ble_gattc_read_char_descr(  
    esp_gatt_if_t      gattc_if,  
    uint16_t          conn_id,
```

```

uint16_t          handle,
esp_gatt_auth_req_t auth_req
)

```

- gattc\_if
- conn\_id
- handle
- auth\_req

Includes:

- #include <esp\_gattc\_api.h>

### esp\_ble\_gattc\_read\_multiple

```

esp_err_t esp_ble_gattc_read_multiple(
    resp_gatt_if_t    gattc_if,
    uint16_t          conn_id,
    esp_gattc_multi_t* read_multi,
    esp_gatt_auth_t   authReq
)

```

- gattc\_if – The GATT client access interface.
- conn\_id – The connection ID to the server.
- read\_multi – Pointer to the read multiple data.
- authReq – Authenticate request type.

### esp\_ble\_gattc\_register\_callback

Register a callback to be invoked when a GATT event is received.

```

esp_err_t esp_ble_gattc_register_callback(esp_gattc_cb_t callback)

```

The `esp_gattc_cb_t` is a C function definition for a function with the signature:

```

void func(
    esp_gattc_cb_event_t    event,
    esp_gatt_if_t          gattc_if,
    esp_ble_gattc_cb_param_t* param
)

```

Event types include:

- ESP\_GATTC\_ACL\_EVT
- ESP\_GATTC\_ADV\_DATA\_EVT
- ESP\_GATTC\_ADV\_VSC\_EVT



- ESP\_GATTC\_BTH\_SCAN\_CFG\_EVT
- ESP\_GATTC\_BTH\_SCAN\_DIS\_EVT
- ESP\_GATTC\_BTH\_SCAN\_ENB\_EVT
- ESP\_GATTC\_BTH\_SCAN\_PARAM\_EVT
- ESP\_GATTC\_BTH\_SCAN\_RD\_EVT
- ESP\_GATTC\_BTH\_SCAN\_THR\_EVT
- ESP\_GATTC\_CANCEL\_OPEN\_EVT
- ESP\_GATTC\_CFG\_MTU\_EVT
- ESP\_GATTC\_CLOSE\_EVT – Invoked when a connection is closed.
- ESP\_GATTC\_CONGEST\_EVT
- ESP\_GATTC\_ENC\_CMPL\_CB\_EVT
- ESP\_GATTC\_EXEC\_EVT
- ESP\_GATTC\_GET\_CHAR\_EVT – Response to getting a characteristic.
- ESP\_GATTC\_GET\_DESCR\_EVT – Response to getting a characteristic description.
- ESP\_GATTC\_GET\_INCL\_SRVC\_EVT
- ESP\_GATTC\_MULT\_ADV\_DATA\_EVT
- ESP\_GATTC\_MULT\_ADV\_DIS\_EVT
- ESP\_GATTC\_MULT\_ADV\_ENB\_EVT
- ESP\_GATTC\_MULT\_ADV\_UPD\_EVT
- ESP\_GATTC\_NOTIFY\_EVT
- ESP\_GATTC\_OPEN\_EVT – Invoked when a connection is opened.
- ESP\_GATTC\_PREP\_WRITE\_EVT – Response to write a characteristic.
- ESP\_GATTC\_READ\_CHAR\_EVT – Response to read a characteristic.
- ESP\_GATTC\_REG\_EVT – Invoked when a GATT client has been registered.
- ESP\_GATTC\_REG\_FOR\_NOTIFY\_EVT
- ESP\_GATTC\_SCAN\_FLT\_CFG\_EVT
- ESP\_GATTC\_SCAN\_FLT\_PARAM\_EVT
- ESP\_GATTC\_SCAN\_FLT\_STATUS\_EVT

- `ESP_GATTC_SEARCH_CMPL_EVT` – Invoked when we have seen all search results.
- `ESP_GATTC_SEARCH_RES_EVT` – Invoked when we have a search result.
- `ESP_GATTC_SRVC_CHG_EVT`
- `ESP_GATTC_READ_DESCR_EVT`
- `ESP_GATTC_UNREG_EVT`
- `ESP_GATTC_UNREG_FOR_NOTIFY_EVT`
- `ESP_GATTC_WRITE_CHAR_EVT`
- `ESP_GATTC_WRITE_DESCR_EVT`

The `param` is a data structure that provides further details on the event. It appears to be an instance of `esp_ble_gattc_cb_param_t` which is a union of:

- `cfg_mtu` – set for `ESP_GATTC_CFG_MTU_EVT`.
- `close` – set for `ESP_GATTC_CLOSE_EVT`.
- `congest` – `ESP_GATTC_CONGEST_EVT`.
- `exec_cmpl` – set for `ESP_GATTC_EXEC_EVT`.
- `get_char` – set for `ESP_GATTC_GET_CHAR_EVT`.
- `get_descr` – set for `ESP_GATTC_GET_DESCR_EVT`.
- `get_incl_srvc` – set for `ESP_GATTC_GET_INCL_SRVC_EVT`.
- `notify` – set for `ESP_GATTC_NOTIFY_EVT`.
- `open` – set for `ESP_GATTC_OPEN_EVT`.
- `read` – set for `ESP_GATTC_READ_CHAR_EVT` and `ESP_GATTC_READ_DESCR_EVT`.
- `reg` – set for `ESP_GATTC_REG_EVT`.
- `reg_for_notify` – set for `ESP_GATTC_REG_FOR_NOTIFY_EVT`.
- `search_cmpl` – set for `ESP_GATTC_SEARCH_CMPL_EVT`.
- `search_res` – set for `ESP_GATTC_SEARCH_RES_EVT`.
- `srvc_chg` – set for `ESP_GATTC_SRVC_CHG_EVT`.
- `unreg_for_notify` – set for `ESP_GATTC_UNREG_FOR_NOTIFY_EVT`.
- `write` – set for `ESP_GATTC_WRITE_CHAR_EVT`, `ESP_GATTC_PREP_WRITE_EVT` and `ESP_GATTC_WRITE_DESCR_EVT`.

Includes:

- `#include <esp_gattc_api.h>`

Now let us look more deeply at each event type.

ESP\_GATTC\_ACL\_EVT

ESP\_GATTC\_ADV\_DATA\_EVT

ESP\_GATTC\_ADV\_VSC\_EVT

ESP\_GATTC\_BTH\_SCAN\_CFG\_EVT

ESP\_GATTC\_BTH\_SCAN\_DIS\_EVT

ESP\_GATTC\_BTH\_SCAN\_ENB\_EVT

ESP\_GATTC\_BTH\_SCAN\_PARAM\_EVT

ESP\_GATTC\_BTH\_SCAN\_RD\_EVT

ESP\_GATTC\_BTH\_SCAN\_THR\_EVT

ESP\_GATTC\_CANCEL\_OPEN\_EVT

ESP\_GATTC\_CFG\_MTU\_EVT

`struct gattc_cfg_mtu_evt_param`

`cfg_mtu`

- `esp_gatt_status_t status`
- `uint16_t conn_id`
- `uint16_t mtu`

ESP\_GATTC\_CLOSE\_EVT

Published when a GATT client connection is closed. This will commonly be the result of a call to `esp_ble_gattc_close()`. The `close` field of `esp_ble_gattc_cb_param_t` is populated. It contains:

- `esp_gatt_status_t status` – Operation status.
- `uint16_t conn_id` – Connection id.
- `esp_gatt_if_t gatt_if` – Gatt interface id, different application on gatt client different `gatt_if`.

- `esp_bd_addr_t remote_bda` – Remote bluetooth device address.
- `esp_gatt_conn_reason_t reason` – The reason of gatt connection close. One of:
  - `ESP_GATT_CONN_UNKNOWN` – Gatt connection unknown.
  - `ESP_GATT_CONN_L2C_FAILURE` – General L2cap failure.
  - `ESP_GATT_CONN_TIMEOUT` – Connection timeout.
  - `ESP_GATT_CONN_TERMINATE_PEER_USER` – Connection terminate by peer user.
  - `ESP_GATT_CONN_TERMINATE_LOCAL_HOST` – Connection terminated by local host.
  - `ESP_GATT_CONN_FAIL_ESTABLISH` – Connection failed to establish.
  - `ESP_GATT_CONN_LMP_TIMEOUT` – Connection failed for LMP response time out.
  - `ESP_GATT_CONN_CONN_CANCEL` – L2CAP connection canceled.
  - `ESP_GATT_CONN_NONE` – No connection to cancel.

See also:

- `esp_ble_gattc_close`
- `ESP_GATTC_DISCONNECT_EVT`

#### ESP\_GATTC\_CONGEST\_EVT

`struct gattc_congest_evt_param`

`congest`

- `uint16_t conn_id`
- `bool congested`

#### ESP\_GATTC\_CONNECT\_EVT

`struct gattc_connect_evt_param`

`connect`

- `esp_gatt_status_t status`
- `uint16_t conn_id`
- `esp_bd_addr_t remote_bda`

### ESP\_GATTC\_DISCONNECT\_EVT

struct gattc\_disconnect\_evt\_param

disconnect

- esp\_gatt\_conn\_reason\_t reason – The reason for the disconnection.
- uint16\_t conn\_id – The connection id that was disconnected.
- esp\_bd\_addr\_t remote\_bda – The remote address of the peer BLE device.

### ESP\_GATTC\_ENC\_CMPL\_CB\_EVT

#### ESP\_GATTC\_EXEC\_EVT

struct gattc\_exec\_cmpl\_evt\_param

exec\_cmpl

- esp\_gatt\_status\_t status
- uint16\_t conn\_id

### ESP\_GATTC\_GET\_CHAR\_EVT

**Warning: Removed in ESP-IDF 3.0**

Published when a GATT call to esp\_ble\_gattc\_get\_characteristic() has been made.

The get\_char field of esp\_ble\_gattc\_cb\_param\_t is populated. It contains:

- esp\_gatt\_status\_t status – Operation status. On success, ESP\_GATT\_OK is returned.
- uint16\_t conn\_id – Connection id.
- esp\_gatt\_srvc\_id\_t srvc\_id – Service id, includes service uuid and other information.
- esp\_gatt\_id\_t char\_id – Characteristic id, include characteristic uuid and other information. If the status field indicates an error, this field should not be examined.
  - esp\_bt\_uuid\_t uuid
  - uint8\_t inst\_id

- `esp_gatt_char_prop_t char_prop` – Characteristic properties. This is the set of flags that identify what can be done against the characteristic. If the status field indicates an error, this field should not be examined. The bit flags are:
  - `ESP_GATT_CHAR_PROP_BIT_AUTH`
  - `ESP_GATT_CHAR_PROP_BIT_BROADCAST`
  - `ESP_GATT_CHAR_PROP_BIT_EXT_PROP`
  - `ESP_GATT_CHAR_PROP_BIT_INDICATE`
  - `ESP_GATT_CHAR_PROP_BIT_NOTIFY`
  - `ESP_GATT_CHAR_PROP_BIT_READ`
  - `ESP_GATT_CHAR_PROP_BIT_WRITE`
  - `ESP_GATT_CHAR_PROP_BIT_WRITE_NR`

See also:

- `esp_ble_gattc_get_characteristic`

#### ESP\_GATTC\_GET\_DESCR\_EVT

**Warning: Removed in ESP-IDF 3.0**

`struct gattc_get_descr_evt_param`

`get_descr`

- `esp_gatt_status_t status`
- `uint16_t conn_id`
- `esp_gatt_srv_id_t srv_id`
- `esp_gatt_id_t char_id`
- `esp_gatt_id_t descr_id`

#### ESP\_GATTC\_GET\_INCL\_SRVC\_EVT

**Warning: Removed in ESP-IDF 3.0**

`struct gattc_get_incl_srvc_evt_param`

`get_incl_srvc`

- `esp_gatt_status_t status`

- `uint16_t conn_id`
- `esp_gatt_srv_id_t srv_id`
- `esp_gatt_srv_id_t incl_srv_id`

#### ESP\_GATTC\_MULT\_ADV\_DATA\_EVT

#### ESP\_GATTC\_MULT\_ADV\_DIS\_EVT

#### ESP\_GATTC\_MULT\_ADV\_ENB\_EVT

#### ESP\_GATTC\_MULT\_ADV\_UPD\_EVT

#### ESP\_GATTC\_NOTIFY\_EVT

**Warning: Changed in ESP-IDF 3.0**

Received when the server indicates/notify that a characteristic value has changed. The `notify` field of the `esp_ble_gattc_cb_param_t` is populated. It contains:

- `uint16_t conn_id` – The connection id
- `esp_bd_addr_t remote_bda` – The address of the partner
- `uint16_t handle` – The handle of the attribute that changed.
- `uint16_t value_len` – The length of the new data.
- `uint8_t* value` – The new data
- `bool is_notify` – True if this is a notify, false if it is an indicate.

#### ESP\_GATTC\_OPEN\_EVT

Published when a GATT client open call has been made. This is normally the result of calling `esp_ble_gattc_open()`. The `open` field of `esp_ble_gattc_cb_param_t` is populated. It contains:

- `esp_gatt_status_t status` – Operation status. The status should be checked to see what the outcome of the request may be. A good return is `ESP_GATT_OK`.
- `uint16_t conn_id` – Connection id.
- `esp_gatt_if_t gatt_if` – GATT interface id, different application on GATT client different `gatt_if`
- `esp_bd_addr_t remote_bda` – Remote bluetooth device address.
- `uint16_t mtu` – MTU size.

See also:

- `esp_ble_gattc_open`

### ESP\_GATTC\_PREP\_WRITE\_EVT

### ESP\_GATTC\_READ\_CHAR\_EVT

**Warning: Changed in ESP-IDF 3.0**

Published when a GATT characteristic value has been received. The `read` field of `esp_ble_gattc_cb_param_t` is populated. It contains:

- `esp_gatt_status_t status` – Operation status.
- `uint16_t conn_id` – Connection id.
- `uint16_t handle` – Handle id.
- `uint8_t* value` – Characteristic value.
- `uint16_t value_len` – Characteristic value length.

See also:

- `esp_ble_gattc_read_char`

### ESP\_GATTC\_READ\_DESC\_EVT

### ESP\_GATTC\_REG\_EVT

Published when a GATT client has been registered. This will result from a previous call to `esp_ble_gattc_app_register()`. The `reg` field of `esp_ble_gattc_cb_param_t` is populated. It contains:

- `esp_gatt_status_t status` – Operation status. A GATT status code.



- `uint16_t app_id` – Application id which input in register API.

See also:

- `esp_ble_gattc_app_register`

#### ESP\_GATTC\_REG\_FOR\_NOTIFY\_EVT

**Warning: Changed in ESP-IDF 3.0**

Following a call to `esp_ble_gattc_register_for_notify`, this event will be returned.

`struct gattc_reg_for_notify_evt_param`

`reg_for_notify`

- `esp_gatt_status_t status`
- `uint16_t handle`

See also:

- `esp_ble_gattc_register_for_notify`

#### ESP\_GATTC\_SEARCH\_CMPL\_EVT

Published when all search results has been received following a call to `esp_ble_gattc_search_service()`. The `search_cmpl` field of `esp_ble_gattc_cb_param_t` is populated. It contains:

- `esp_gatt_status_t status` – Operation status.
- `uint16_t conn_id` – Connection id.

See also:

- `esp_ble_gattc_search_service`

#### ESP\_GATTC\_SEARCH\_RES\_EVT

**Warning: Changed in ESP-IDF 3.0**

Published a search result has been received following a call to `esp_ble_gattc_search_service()`. The `search_res` field of `esp_ble_gattc_cb_param_t` is populated. This is an instance of `struct gattc_search_res_evt_param`. It contains:

- `uint16_t conn_id` – Connection id.

- `uint16_t start_handle` – The start handle of the service.
- `uint16_t end_handle` – The end handle of the service.
- `esp_gatt_id_t srvc_id` – The `srvcid`. This contains
  - `esp_gatt_id_t id` – The identity of the service.
    - `esp_bt_uuid_t uuid` – The UUID of the service.
    - `uint8_t inst_id` – The instance index of this service on the server.

See also:

- `esp_ble_gattc_search_service`
- `esp_ble_gattc_get_characteristic`
- `ESP_GATTC_SEARCH_CMPL_EVT`
- `esp_gatt_id_t`

[ESP\\_GATTC\\_SCAN\\_FLT\\_CFG\\_EVT](#)

[ESP\\_GATTC\\_SCAN\\_FLT\\_PARAM\\_EVT](#)

[ESP\\_GATTC\\_SCAN\\_FLT\\_STATUS\\_EVT](#)

[ESP\\_GATTC\\_SRVC\\_CHG\\_EVT](#)

`struct gattc_srvc_chg_evt_param`

- `srvc_chg`
- `esp_bd_addr_t remote_bda`

[ESP\\_GATTC\\_UNREG\\_EVT](#)

[ESP\\_GATTC\\_UNREG\\_FOR\\_NOTIFY\\_EVT](#)

**Warning: Changed in ESP-IDF 3.0**

`struct gattc_unreg_for_notify_evt_param`

`unreg_for_notify`

- `esp_gatt_status_t status`
- `uint16_t handle`

See also:

- `esp_ble_gattc_unregister_for_notify`

## ESP\_GATTC\_WRITE\_CHAR\_EVT

**Warning: Changed in ESP-IDF 3.0**

struct gattc\_write\_evt\_param

write

- esp\_gatt\_status\_t status
- uint16\_t conn\_id
- uint16\_t handle

## **esp\_ble\_gattc\_register\_for\_notify**

**Warning: Changed in ESP-IDF 3.0**

Called to register for notification.

```
esp_err_t esp_ble_gattc_register_for_notify(  
    esp_gatt_if_t gattc_if,  
    esp_bd_addr_t server_bda,  
    uint16_t      handle  
)
```

- gattc\_if – Interface to partner.
- server\_bda – Bluetooth device address
- handle – Handle for the characteristic against which we wish to register for notifications.

Subsequent to this call, we should expect to receive an `ESP_GATTC_REG_FOR_NOTIFY_EVT`.

Includes:

- `#include <esp_gattc_api.h>`

See also:

- `ESP_GATTC_REG_FOR_NOTIFY_EVT`

## **esp\_ble\_gattc\_unregister\_for\_notify**

**Warning: Changed in ESP-IDF 3.0**

```
esp_err_t esp_ble_gattc_unregister_for_notify (  
    esp_gatt_if_t gattc_if,  
    esp_bd_addr_t server_bda,
```

```
uint16_t      handle
)
```

- gattc\_if
- server\_bda
- handle

Includes:

- #include <esp\_gattc\_api.h>

### esp\_ble\_gattc\_search\_service

Ask the BLE device for the set of services it provides. The services will be returned asynchronously via GATT events.

```
esp_err_t esp_ble_gattc_search_service(
    esp_gatt_if_t  gattc_if,
    uint16_t       conn_id,
    esp_bt_uuid_t* filter_uuid)
```

The `gattc_if` is returned to us in the open event callback.

The `conn_id` is the identity of a connection that was opened by a call to `esp_ble_gattc_open()` and obtained from a GATT event callback.

The `filter_uuid` allows us to filter UUIDs or else we can specify `NULL`.

After calling this function we might expect to see a sequence of `ESP_GATTC_SEARCH_RES_EVT` events published finalized with an `ESP_GATTC_SEARCH_CMPL_EVT`.

Includes:

- #include <esp\_gattc\_api.h>

See also:

- `ESP_GATTC_SEARCH_CMPL_EVT`
- `ESP_GATTC_SEARCH_RES_EVT`
- `esp_ble_gattc_get_service`

### esp\_ble\_gattc\_write\_char

**Warning: Changed in ESP-IDF 3.0**

Set the value of a remote device's characteristic.

```
esp_err_t esp_ble_gattc_write_char(
    esp_gatt_if_t      gattc_if,
    uint16_t           conn_id,
```

```

uint16_t          handle,
uint16_t          value_len,
uint8_t*         value,
esp_gatt_write_type_t write_type,
esp_gatt_auth_req_t auth_req)

```

- **esp\_gatt\_if\_t gattc\_if**
- **uint16\_t conn\_id**
- **uint16\_t handle**
- **uint16\_t value\_len** – The length, in bytes, of the value.
- **uint8\_t\* value** – A pointer to the start of the data for the value.
- **esp\_gatt\_write\_type\_t write\_type** – Whether or not we require a response.
  - **ESP\_GATT\_WRITE\_TYPE\_NO\_RSP**
  - **ESP\_GATT\_WRITE\_TYPE\_RSP**
- **esp\_gatt\_auth\_req\_t auth\_req** – The authentication:
  - **ESP\_GATT\_AUTH\_REQ\_NONE**
  - **ESP\_GATT\_AUTH\_REQ\_NO\_MITM**
  - **ESP\_GATT\_AUTH\_REQ\_MITM**
  - **ESP\_GATT\_AUTH\_REQ\_SIGNED\_NO\_MITM**
  - **ESP\_GATT\_AUTH\_REQ\_SIGNED\_MITM**

Includes:

- `#include <esp_gattc_api.h>`

See also:

- `ESP_GATTC_WRITE_CHAR_EVT`

## esp\_ble\_gattc\_write\_char\_descr

**Warning: Changed in ESP-IDF 3.0**

```

esp_err_t esp_ble_gattc_write_char_descr(
    esp_gatt_if_t      gattc_if,
    uint16_t           conn_id,
    uint16_t           handle,
    uint16_t           value_len,
    uint8_t*          value,
    esp_gatt_write_type_t write_type,
    esp_gatt_auth_req_t auth_req)

```

- `esp_gatt_if_t gattc_if` – Interface to the BLE device.
- `uint16_t conn_id` – Connection to the remote device.
- `uint16_t handle` – Descriptor handle.
- `uint16_t value_len` – Number of bytes in the value.
- `uint8_t* value` – Pointer to the value to write.
- `esp_gatt_write_t write_type` – Whether or not we require a response.
  - `ESP_GATT_WRITE_TYPE_NO_RSP`
  - `ESP_GATT_WRITE_TYPE_RSP`
- `esp_gatt_auth_req_t auth_req` – The authentication:
  - `ESP_GATT_AUTH_REQ_NONE`
  - `ESP_GATT_AUTH_REQ_NO_MITM`
  - `ESP_GATT_AUTH_REQ_MITM`
  - `ESP_GATT_AUTH_REQ_SIGNED_NO_MITM`
  - `ESP_GATT_AUTH_REQ_SIGNED_MITM`

Includes:

- `#include <esp_gattc_api.h>`

### `esp_ble_gatts_add_char`

Add a characteristic to the service.

```
esp_err_t esp_ble_gatts_add_char(
    uint16_t          serviceHandle,
    esp_bt_uuid_t*   characteristicUuid,
    esp_gatt_perm_t   permissions,
    esp_gatt_char_prop_t properties,
    esp_attr_value_t* characteristicValue,
    esp_attr_control_t* control)
```

Within BLE we have the notion of a service and a service can have zero or more characteristics associated with it. Invoking this function declares a new characteristic associated with the service. When we think about a characteristic, we should also understand that it has a value associated with it. This value can either be managed by our application logic explicitly or it can be managed by the ESP-IDF environment. The choice is governed by the `control` property. If we set that to be `ESP_GATT_AUTO_RSP` then the ESP environment is managing our value on our behalf and we must supply an initial value through the `characteristicValue` parameter. However, if we set the control

parameter to be `ESP_GATT_RSP_BY_APP` then we are declaring that there will be events arriving to set/get our characteristic value.

- `serviceHandle` – Attribute handle for the service to which this characteristic is to be added.
- `characteristicUuid` – UUID for the characteristic.
- `permissions` – Attribute permissions. These can be "or'd" together
  - `ESP_GATT_PERM_READ`
  - `ESP_GATT_PERM_READ_ENCRYPTED`
  - `ESP_GATT_PERM_READ_ENC_MITM`
  - `ESP_GATT_PERM_WRITE`
  - `ESP_GATT_PERM_WRITE_ENCRYPTED`
  - `ESP_GATT_PERM_WRITE_ENC_MITM`
  - `ESP_GATT_PERM_WRITE_SIGNED`
  - `ESP_GATT_PERM_WRITE_SIGNED_MITM`
- `properties` – Characteristic properties.
  - `ESP_GATT_CHAR_PROP_BIT_BROADCAST`
  - `ESP_GATT_CHAR_PROP_BIT_READ`
  - `ESP_GATT_CHAR_PROP_BIT_WRITE_NR`
  - `ESP_GATT_CHAR_PROP_BIT_WRITE`
  - `ESP_GATT_CHAR_PROP_BIT_NOTIFY`
  - `ESP_GATT_CHAR_PROP_BIT_INDICATE`
  - `ESP_GATT_CHAR_PROP_BIT_AUTH`
  - `ESP_GATT_CHAR_PROP_BIT_EXT_PROP`
- `characteristicValue` – Characteristic value.
  - `uint16_t attr_max_len`
  - `uint16_t attr_len`
  - `uint8_t *attr_value`
- `control` – Control flags.
  - `auto_rsp` – How to automatically respond.

- ESP\_GATT\_RSP\_BY\_APP
- ESP\_GATT\_AUTO\_RSP

Includes:

- #include <esp\_gatts\_api.h>

See also:

- ESP\_GATTS\_ADD\_CHAR\_EVT

### esp\_ble\_gatts\_add\_char\_descr

```
esp_err_t esp_ble_gatts_add_char_descr(
    uint16_t          serviceHandle,
    esp_bt_uuid_t*    descriptorUuid,
    esp_gatt_perm_t   permissions,
    esp_attr_value_t* characteristicDescriptorValue,
    esp_attr_control_t* control)
```

- `serviceHandle` – The handle of the service to which to add this characteristic descriptor.
- `descriptorUuid` – The UUID for the new descriptor.
- `permissions` – Attribute permissions. These can be "or'd" together
  - ESP\_GATT\_PERM\_READ
  - ESP\_GATT\_PERM\_READ\_ENCRYPTED
  - ESP\_GATT\_PERM\_READ\_ENC\_MITM
  - ESP\_GATT\_PERM\_WRITE
  - ESP\_GATT\_PERM\_WRITE\_ENCRYPTED
  - ESP\_GATT\_PERM\_WRITE\_ENC\_MITM
  - ESP\_GATT\_PERM\_WRITE\_SIGNED
  - ESP\_GATT\_PERM\_WRITE\_SIGNED\_MITM
- `characteristicDescriptorValue` – Characteristic descriptor value:
  - `uint16_t attr_max_len`
  - `uint16_t attr_len`
  - `uint8_t *attr_value`
- `control` – Control flags.
  - `auto_rsp` – How to automatically respond.



- ESP\_GATT\_RSP\_BY\_APP
- ESP\_GATT\_AUTO\_RSP

Includes:

- #include <esp\_gatts\_api.h>

See also:

- ESP\_GATTS\_ADD\_CHAR\_DESCR\_EVT

### **esp\_ble\_gatts\_add\_included\_service**

```
esp_err_t esp_ble_gatts_add_included_service(
    uint16_t service_handle,
    uint16_t included_service_handle)
```

Includes:

- #include <esp\_gatts\_api.h>

See also:

- ESP\_GATTS\_ADD\_INCL\_SRVC\_EVT

### **esp\_ble\_gatts\_app\_register**

```
esp_err_t esp_ble_gatts_app_register(uint16_t app_id)
```

The `app_id` is the identity of an application. This can be any numeric smaller than 0x7fff.

Includes:

- #include <esp\_gatts\_api.h>

See also:

- ESP\_GATTS\_REG\_EVT

### **esp\_ble\_gatts\_app\_unregister**

```
esp_err_t esp_ble_gatts_app_unregister(esp_gatt_if_t gatts_if)
```

Includes:

- #include <esp\_gatts\_api.h>

## esp\_ble\_gatts\_close

Close a connection that was opened by a client.

```
esp_err_t esp_ble_gatts_close(  
    esp_gatt_if_t gatts_if,  
    uint16_t conn_id)
```

Includes:

- `#include <esp_gatts_api.h>`

See also:

- `ESP_GATTS_CLOSE_EVT`

## esp\_ble\_gatts\_create\_attribute\_tab

Have the attributes automatically maintained for us.

```
esp_err_t esp_ble_gatts_create_attr_tab(  
    const esp_gatts_attr_db_t* gatts_attr_db,  
    esp_gatt_if_t gatts_if,  
    uint8_t max_nb_attr,  
    uint8_t srvc_inst_id)
```

- `gatts_attr_db`
- `gatts_if`
- `max_nb_attr`
- `srvc_inst_id`

Don't mix this technique with `esp_gatts_create_service/esp_ble_gatts_add_char`.

Includes:

- `#include <esp_gatts_api.h>`

See also:

- `esp_ble_gatts_set_attr_value`
- `esp_ble_gatts_get_attr_value`

## esp\_ble\_gatts\_create\_service

Create a service definition.

```
esp_err_t esp_ble_gatts_create_service(  
    esp_gatt_if_t gatts_if,  
    esp_gatt_srvc_id_t* service_id,  
    uint16_t num_handles)
```

The `service_id` is a structure containing the identity of the service.

- `esp_gatt_id_t id`
- `bool is_primary`

The `num_handle` is the number of handles requested for this service. This takes a bit of explanation. When a service is created, it will need a set of handles associated with it. There will be one handle for the service itself and then handles for each characteristic and handles for each descriptor (if any) for each characteristic. One of the rules of the BLE specification is that handles have to be grouped together to form a range. For example, we may say that handles 0x20 to 0x2F correspond to a single service. There can't be handles in that numeric range that belong to a different service. Note that handles don't have to be directly consecutive. For example, for a given service, we might find 0x20, 0x21, 0x24, 0x26 as handles.

When we create a service against the ESP32 BLE subsystem, the ESP32 allocates a handle and returns it to us. However, what if we create two services? What should the value of the second handle be? It shouldn't be sequential to the first handle because there would be no room for characteristic and descriptor handles and it shouldn't be *too far away* from the first handle that we will run out of handles if we try and create too many services. The solution adopted is to allow the programmer to define the anticipated maximum number of handles needed to be associated with the service. What this means is that if say we need  $n$  handles when we request a service, then the ESP32 BLE stack will allocate the handle  $h$  to  $h+n-1$  for the service. If a second service is requested, its handle will be on or after the handle value of  $h+n$ .

A call to this function will result in an eventual `ESP_GATTS_CREATE_EVT` event being raised. It is that event which will contain the service handle used in subsequent calls.

Here is a practical example.

Imagine we have an ESP32 running a BLE server. If we then use `bluetoothctl` on a Linux system, connect to the BLE server and then perform the `list-attributes` command, we may get an output as follows:

```
Primary Service
  /org/bluez/hci0/dev_24_0A_C4_11_A5_16/service0028
  4fafc200-1fb5-459e-8fcc-c5c9c331914b
  Vendor specific
Characteristic
  /org/bluez/hci0/dev_24_0A_C4_11_A5_16/service0028/char0029
  4fafc201-1fb5-459e-8fcc-c5c9c331914b
  Vendor specific
Descriptor
  /org/bluez/hci0/dev_24_0A_C4_11_A5_16/service0028/char0029/desc002b
  00002902-0000-1000-8000-00805f9b34fb
  Client Characteristic Configuration
```

```
Primary Service
  /org/bluez/hci0/dev_24_0A_C4_11_A5_16/service0001
  00001801-0000-1000-8000-00805f9b34fb
  Generic Attribute Profile
Characteristic
  /org/bluez/hci0/dev_24_0A_C4_11_A5_16/service0001/char0002
  00002a05-0000-1000-8000-00805f9b34fb
  Service Changed
```

Let us look at just one "path" entry ... for example:

```
/org/bluez/hci0/dev_24_0A_C4_11_A5_16/service0028/char0029/desc002b
```

The way to read this is that we are looking at BLE device with address 24:0A:C4:11:A5:16. This is a descriptor associated with a service with a handle of 0x28 which has a characteristic at handle 0x29 which has a descriptor with handle 0x2b.

Another tool we can use is `gatttool`. Using this we can connect to the BLE server and run "primary" which will show the exposed services... for example:

```
attr handle: 0x0001, end grp handle: 0x0005 uuid: 00001801-0000-1000-8000-00805f9b34fb
attr handle: 0x0014, end grp handle: 0x001c uuid: 00001800-0000-1000-8000-00805f9b34fb
attr handle: 0x0028, end grp handle: 0xffff uuid: 4fafc200-1fb5-459e-8fcc-c5c9c331914b
```

This shows that there are three services exposed with handles in the ranges of 0x01 to 0x05, 0x14 to 0x1c and 0x28 to 0xffff.

If we wish to see a list of all handles in use, we can run the `char-desc` command:

```
handle: 0x0001, uuid: 00002800-0000-1000-8000-00805f9b34fb
handle: 0x0002, uuid: 00002803-0000-1000-8000-00805f9b34fb
handle: 0x0003, uuid: 00002a05-0000-1000-8000-00805f9b34fb
handle: 0x0014, uuid: 00002800-0000-1000-8000-00805f9b34fb
handle: 0x0015, uuid: 00002803-0000-1000-8000-00805f9b34fb
handle: 0x0016, uuid: 00002a00-0000-1000-8000-00805f9b34fb
handle: 0x0017, uuid: 00002803-0000-1000-8000-00805f9b34fb
handle: 0x0018, uuid: 00002a01-0000-1000-8000-00805f9b34fb
handle: 0x0019, uuid: 00002803-0000-1000-8000-00805f9b34fb
handle: 0x001a, uuid: 00002aa6-0000-1000-8000-00805f9b34fb
handle: 0x0028, uuid: 00002800-0000-1000-8000-00805f9b34fb
handle: 0x0029, uuid: 00002803-0000-1000-8000-00805f9b34fb
handle: 0x002a, uuid: 4fafc201-1fb5-459e-8fcc-c5c9c331914b
handle: 0x002b, uuid: 00002902-0000-1000-8000-00805f9b34fb
```

This basically shows us the content of the table.

- UUID 0x2800 – Primary service – Payload - UUID
- UUID 0x2803 – Characteristics declaration -
  - Characteristic properties (1 byte)
  - Characteristic value handle (2 bytes)

- Characteristic UUID (2, 4, 16 bytes)

Includes:

- `#include <esp_gatts_api.h>`

See also:

- `ESP_GATTS_CREATE_EVT`
- `esp_gatt_srv_id_t`

### **esp\_ble\_gatts\_delete\_service**

```
esp_err_t esp_ble_gatts_delete_service(uint16_t service_handle);
```

Includes:

- `#include <esp_gatts_api.h>`

See also:

- `ESP_GATTS_DELETE_EVT`

### **esp\_ble\_gatts\_get\_attr\_value**

```
esp_err_t esp_ble_gatts_get_attr_value(
    uint16_t attr_handle,
    uint16_t *length,
    const uint8_t **value)
```

Includes:

- `#include <esp_gatts_api.h>`

### **esp\_ble\_gatts\_open**

```
esp_err_t esp_ble_gatts_open(
    esp_gatt_if_t gatts_if,
    esp_bd_addr_t remote_bda,
    bool is_direct)
```

Includes:

- `#include <esp_gatts_api.h>`

See also:

- `ESP_GATTS_OPEN_EVT`

## esp\_ble\_gatts\_register\_callback

Register GATT server callbacks.

```
esp_err_t esp_ble_gatts_register_callback(esp_gatts_cb_t callback)
```

The callback is an instance of a callback function that has the following signature:

```
void callback(  
    esp_gatts_cb_event_t event,  
    esp_gatt_if_t gatts_if,  
    esp_ble_gatts_cb_param_t *param  
)
```

The `esp_ble_gatts_cb_param_t` is a union of:

- `struct gatts_add_attr_tab_evt_param add_attr_tab`
- `struct gatts_add_char_evt_param add_char`
- `struct gatts_add_char_descr_evt_param add_char_descr`
- `struct gatts_conf_evt_param conf`
- `struct gatts_connect_evt_param connect`
- `struct gatts_create_evt_param create`
- `struct gatts_delete_evt_param del`
- `struct gatts_disconnect_evt_param disconnect`
- `struct gatts_exec_write_evt_param exec_write`
- `struct gatts_mtu_evt_param mtu`
- `struct gatts_read_evt_param read`
- `struct gatts_reg_evt_param reg`
- `struct gatts_rsp_evt_param rsp`
- `struct gatts_set_attr_val_evt_param set_attr_val`
- `struct gatts_start_evt_param start`
- `struct gatts_stop_evt_param stop`
- `struct gatts_write_evt_param write`

The event is one of:

### ESP\_GATTS\_ADD\_CHAR\_DESCR\_EVT

The passed in parameter is an instance of `struct gatts_add_char_descr_evt_param` which is identified by the field called `add_char_descr`. The structure contains:

- `esp_gatt_status_t status` – Status of the descriptor creation.
- `uint16_t attr_handle` – Attribute handle of the descriptor.
- `uint16_t service_handle` – Handle of the service.
- `esp_bt_uuid_t char_uuid` – UUID of descriptor.

See also:

- `esp_ble_gatts_add_char_descr`

### ESP\_GATTS\_ADD\_CHAR\_EVT

When a GATT client connects, we receive this event. The passed in parameter is an instance of `struct gatts_add_char_evt_param` which is identified by the field called `add_char`. The structure contains:

- `esp_gatt_status_t status` – Status of the creation of the characteristic.
- `uint16_t attr_handle` – Attribute handle for the characteristic.
- `uint16_t service_handle` – Service handle.
- `esp_bt_uuid_t char_uuid` – UUID of the characteristic.

See also:

- `esp_ble_gatts_add_char`
- `esp_bt_uuid_t`

### ESP\_GATTS\_ADD\_INCL\_SRVC\_EVT

The passed in parameter is an instance of `struct gatts_add_incl_srvc_evt_param` identified by the field called `add_incl_srvc`. The structure contains:

- `esp_gatt_status_t status`
- `uint16_t attr_handle`
- `uint16_t service_handle`

### ESP\_GATTS\_CANCEL\_OPEN\_EVT

The passed in parameter is an instance of `struct gatts_cancel_open_evt_param` identified by the field called `cancel_open`. The structure contains:

- `esp_gatt_status_t status`

### ESP\_GATTS\_CLOSE\_EVT

The passed in parameter is an instance of `struct gatts_close_evt_param` which is identified by the field called `close`. The structure contains:

- `esp_gatt_status_t status`
- `uint16_t conn_id`

### ESP\_GATTS\_CONF\_EVT

A confirmation event of a request that we issued.

The passed in parameter is an instance of `struct gatts_conf_evt_param` which is identified by the field called `conf`. The structure contains:

- `esp_gatt_status_t status` – The status code.
- `uint16_t conn_id` – The connection used.
- `uint16_t len` – ??? - Only valid when status indicates an error.
- `uint8_t* value` – ??? - Only valid when status indicates an error.

See also:

- `esp_ble_gatts_send_indicate`

### ESP\_GATTS\_CONGEST\_EVT

The passed in parameter is an instance of `struct gatts_congest_evt_param` which is identified by the field called `congest`. The structure contains:

- `uint16_t conn_id`
- `bool congested`

### ESP\_GATTS\_CONNECT\_EVT

When a GATT client connects, we receive this event. The passed in parameter is an instance of `struct gatts_connect_evt_param` which is identified by the field called `connect`. The structure contains:

- `uint16_t conn_id` – The connection id.
- `esp_bd_addr_t remote_bda` – The address of the peer device.
- `bool is_connected` – Are we connected?



### ESP\_GATTS\_CREAT\_ATTR\_TAB\_EVT

The passed in parameter is an instance of `struct gatts_add_attr_tab_evt_param` which is identified by the field called `add_attr_tab`. The structure contains:

- `esp_gatt_status_t` status
- `esp_bt_uuid_t` svc\_uuid
- `uint16_t` num\_handle
- `uint16_t` \*handles

### ESP\_GATTS\_CREATE\_EVT

This event is found when a new service has been created. As such, it is commonly found after a call to `esp_ble_gatts_create_service()`. The passed in parameter is an instance of `struct gatts_create_evt_param` which is identified by the field called `create`. The structure contains:

- `esp_gatt_status_t` status – The status of the creation request.
- `uint16_t` service\_handle – The handle allocated by the environment to this service.
- `esp_gatt_srv_id_t` service\_id – The identity of the service.

See also:

- `esp_ble_gatts_create_service`
- `esp_gatt_srv_id_t`

### ESP\_GATTS\_DELETE\_EVT

The passed in parameter is an instance of `struct gatts_delete_evt_param` which is identified by the field called `del`. The structure contains:

- `esp_gatt_status_t` status
- `uint16_t` service\_handle

### ESP\_GATTS\_DISCONNECT\_EVT

When a GATT client connects, we receive this event. The passed in parameter is an instance of `struct gatts_disconnect_evt_param` which is identified by the field called `disconnect`. The structure contains:

- `uint16_t conn_id` – The connection id that just disconnected.
- `esp_bd_addr_t remote_bda` – The device address of the device which just disconnected.
- `bool is_connected` – Are we connected? Should be false.

If we are a GATT server, following a disconnect, we must start advertising again in order to be able to receive further incoming connections.

See also:

- `esp_ble_gap_config_adv_data`

### ESP\_GATTS\_EXEC\_WRITE\_EVT

The passed in parameter is an instance of `struct gatts_exec_write_evt_param` which is identified by the field called `exec_write`. The structure contains:

- `uint16_t conn_id`
- `uint32_t trans_id`
- `esp_bd_addr_t bda`
- `uint8_t exec_write_flag`
  - `ESP_GATT_PREP_WRITE_CANCEL`
  - `ESP_GATT_PREP_WRITE_EXEC`

Upon receipt of one of these events, we should acknowledge it with a call to `esp_ble_gatts_send_response()`.

See also:

- `ESP_GATTS_WRITE_EVT`
- `esp_ble_gatts_send_response`

### ESP\_GATTS\_LISTEN\_EVT

### ESP\_GATTS\_MTU\_EVT

Called when set MTU complete. The passed in parameter is an instance of `struct gatts_mtu_evt_param` which is identified by the field called `mtu`. The structure contains:

- `uint16_t conn_id` – Connection id.

- `uint16_t mtu` – MTU size.

### ESP\_GATTS\_OPEN\_EVT

The passed in parameter is an instance of `struct gatts_open_evt_param` which is identified by the field called `open`. The structure contains:

- `esp_gatt_status_t status`

### ESP\_GATTS\_READ\_EVT

When a GATT client requests to read an attribute, we receive this event. The passed in parameter is an instance of `struct gatts_read_evt_param` which is identified by the field called `read`. The structure contains:

- `uint16_t conn_id` – Connection id.
- `uint32_t trans_id` – Transfer id.
- `esp_bd_addr_t bda` – Address of partner requesting read.
- `uint16_t handle` – Attribute handle.
- `uint16_t offset` – offset within value.
- `bool is_long` – value is long or not.
- `bool need_rsp` – Read operations needs a response.

See also:

- `esp_ble_gatts_send_response`

### ESP\_GATTS\_REG\_EVT

Invoked when ??.

The passed in parameter is an instance of `struct gatts_reg_evt_param` which is identified by the field called `reg`. The structure contains:

- `esp_gatt_status_t status`
- `uint16_t app_id`

### ESP\_GATTS\_RESPONSE\_EVT

The passed in parameter is an instance of `struct gatts_rsp_evt_param` which is identified by the field called `rsp`. The structure contains:

- `esp_gatt_status_t` status
- `uint16_t` handle

### ESP\_GATTS\_SET\_ATTR\_VAL\_EVT

The passed in parameter is an instance of `struct gatts_set_attr_val_evt_param` which is identified by the field called `set_attr_val`. The structure contains:

- `uint16_t` `srvc_handle`
- `uint16_t` `attr_handle`
- `esp_gatt_status_t` status

### ESP\_GATTS\_START\_EVT

When a GATT service started, we receive this event. As such, this is commonly the response from a call to `esp_ble_gatts_start_service()`. The passed in parameter is an instance of `struct gatts_start_evt_param` which is identified by the field called `start`. The structure contains:

- `esp_gatt_status_t` status
- `uint16_t` `service_handle`

See also:

- `esp_ble_gatts_start_service`

### ESP\_GATTS\_STOP\_EVT

The passed in parameter is an instance of `struct gatts_stop_evt_param` which is identified by the field called `stop`. The structure contains:

- `esp_gatt_status_t` status
- `uint16_t` `service_handle`

### ESP\_GATTS\_UNREG\_EVT

### ESP\_GATTS\_WRITE\_EVT

The passed in parameter is an instance of `struct gatts_write_evt_param` which is identified by the field called `write`. The structure contains:

- `uint16_t conn_id` – The connection id.
- `uint16_t trans_id` – The transfer id.
- `esp_bd_addr_t bda` – The address of the partner.
- `uint16_t handle` – The attribute handle.
- `uint16_t offset` – The offset of the currently received within the whole value.
- `bool need_rsp` – Do we need a response?
- `bool is_prep` – Is this a write prepare? If set, then this is to be considered part of the received value and not the whole value. A subsequent `ESP_GATTS_EXEC_WRITE` will mark the total.
- `uint16_t len` – The length of the incoming value part.
- `uint8_t* value` – The data for this value part.

If a write event arrives and the `need_rsp` is true, we must call `esp_ble_gatts_send_response()` to respond. The response `rsp` structure should contain the handle that we are responding to.

Because the packet size of a BLE message is not very large, and is usually much smaller than the maximum size of a characteristic value, a request to write a new value of a characteristic must arrive as a sequence of packets. This is indicated by the `is_prep` flag being set. The full name for this flag might be considered to be "is part of a prepare to write". The piece parts should arrive and be accumulated without actually setting the value of the characteristic. Once all the parts have arrived and are assembled, an event of type `ESP_GATTS_EXEC_WRITE` will arrive indicating that the accumulated new value is complete and can be written as the value of a characteristic as a complete whole.

The high level algorithm for handling a write may thus be:

```
if (is_prep == TRUE) {
    append this current data to the accumulating data starting at offset in the
    accumulating data. The new total data will be original accumulating data plus
    an additional "len" bytes of new data.
}
```

We should also be aware of `trans_id`. This is an incrementing transfer id. Each part will have a value one higher than the previous value. If we receive a part that is not expected, this can indicate an error to which we can respond appropriately.

The `need_rsp` flag indicates whether or not we should send a response back to the client. If yes, then we call `esp_ble_gatts_send_response()`. The response payload will include the passed in data offset, length and a copy of the received data.

Includes:

- `#include <esp_gatts_api.h>`

See also:

- `esp_ble_gatts_send_response`
- `ESP_GATTS_EXEC_WRITE_EVT`

### `esp_ble_gatts_send_indicate`

Send an indication or notification to the GATT client.

```
esp_err_t esp_ble_gatts_send_indicate(  
    esp_gatt_if_t gatts_if,  
    uint16_t      conn_id,  
    uint16_t      attr_handle,  
    uint16_t      value_len,  
    uint8_t*      value,  
    bool          need_confirm);
```

Note that the BLE specification constrains the maximum data size to be 20 bytes or less. If we try and send more, the data is truncated to 20 bytes. If more data needs to be sent, consider using the indication as an indication of new/more data being available and have the partner perform a read request to get the full span of data.

- `esp_gatt_if_t gatts_if` – The interface on which to send the indication.
- `uint16_t conn_id` – The connection on which to send the indication.
- `uint16_t attr_handle` – The handle of the characteristic we are indicating.
- `uint16_t value_len` – The length of the data value. The maximum data size is 20 bytes.
- `uint8_t* value` – The data value.
- `bool need_confirm` – Whether or not we need a confirmation from the peer. If we ask for a confirmation the request is known as `indicate` while if we don't require a confirmation, the request is known as a `notify`.

The `need_confirm` requires a little explanation. If set to false, then we **will** receive a `ESP_GATTS_CONF_EVT` event ... but this will be from the *local* BLE stack indicating whether or not the request was transmitted.

Includes:

- `#include <esp_gatts_api.h>`

See also:

- ESP\_GATTS\_CONF\_EVT

## esp\_ble\_gatts\_send\_response

Send a response back for a request.

```
esp_err_t esp_ble_gatts_send_response(  
    esp_gatt_if_t    gatts_if,  
    uint16_t         conn_id,  
    uint32_t         trans_id,  
    esp_gatt_status_t status,  
    esp_gatt_rsp_t*  rsp)
```

- gatts\_if – The server access interface.
- conn\_id – The connection id.
- trans\_id – The transfer id.
- status – The status. ESP\_GATT\_OK for normal.
- rsp – The response to send back to the partner. A union of:
  - esp\_gatt\_value\_t attr\_value
    - uint16\_t value[ESP\_GATT\_MAX\_ATTR\_LEN] // 600 bytes
    - uint16\_t handle
    - uint16\_t offset
    - uint16\_t len
    - uint16\_t auth\_req – Authorization
      - ESP\_GATT\_AUTH\_REQ\_NONE
      - ESP\_GATT\_AUTH\_REQ\_NO\_MITM
      - ESP\_GATT\_AUTH\_REQ\_MITM
      - ESP\_GATT\_AUTH\_REQ\_SIGNED\_NO\_MITM
      - ESP\_GATT\_AUTH\_REQ\_SIGNED\_MITM
  - uint16\_t handle

The responses sent back from the server are indications of outcome for the following events:

- ESP\_GATTS\_EXEC\_WRITE\_EVT

- ESP\_GATTS\_READ\_EVT
- ESP\_GATTS\_WRITE\_EVT

Includes:

- `#include <esp_gatts_api.h>`

See also:

- ESP\_GATTS\_READ\_EVT

### **esp\_ble\_gatts\_set\_attr\_value**

```
esp_err_t esp_ble_gatts_set_attr_value(
    uint16_t      attr_handle,
    uint16_t      length,
    const uint8_t* value)
```

Includes:

- `#include <esp_gatts_api.h>`

### **esp\_ble\_gatts\_start\_service**

Start the service identified by the service handle.

```
esp_err_t esp_ble_gatts_start_service(uint16_t serviceHandle)
```

The `serviceHandle` is the local handle for the service. This is the value returned when we created the service and received the corresponding `ESP_GATTS_CREATE_EVT`.

A call to this function will result in an eventual `ESP_GATTS_START_EVT` event being raised.

Includes:

- `#include <esp_gatts_api.h>`

See also:

- ESP\_GATTS\_START\_EVT
- `esp_ble_gatts_create_service`

### **esp\_ble\_gatts\_stop\_service**

```
esp_err_t esp_ble_gatts_stop_service(uint16_t service_handle)
```

Includes:

- `#include <esp_gatts_api.h>`

See also:

- ESP\_GATTS\_STOP\_EVT



## esp\_ble\_resolve\_adv\_data

Resolve Advertized data.

```
uint8_t *esp_ble_resolve_adv_data(  
    uint8_t *adv_data,  
    uint8_t type,  
    uint8_t *length)
```

When a GAP protocol callback occurs, one of the event types that can cause this is the `ESP_GAP_BLE_SCAN_RESULT_EVT` which indicates that we have received a scan result. If found, we can further ask what kind of a result and we can get an `ESP_GAP_SEARCH_INQ_RES_EVT`. If that is the case, then our ADV data is good and we can "decode it".

The `adv_data` is a pointer to the advertized data.

The type specifies the decode value. In the spec this is also known as the "Advertising Data Type"

- `ESP_BLE_AD_TYPE_FLAG (0x01)` – The advert contains flags that are defined as following:
  - Bit 0 – LE Limited Discoverable Mode
  - Bit 1 – LE General Discoverable Mode
  - Bit 2 – BR/EDR is NOT supported.
  - Bit 3 – Indicates whether LE and BR/EDR Controller operates simultaneously
  - Bit 4 – Indicates whether LE and BR/EDR Host operates simultaneously
  - Bits 5-7 – Reserved.
- `ESP_BLE_AD_TYPE_16SRV_PART (0x02)` – Incomplete list of 16bit service class UUIDs.
- `ESP_BLE_AD_TYPE_16SRV_CMPL (0x03)`
- `ESP_BLE_AD_TYPE_32SRV_PART (0x04)`
- `ESP_BLE_AD_TYPE_32SRV_CMPL (0x05)`
- `ESP_BLE_AD_TYPE_128SRV_PART (0x06)` – Incomplete list of 16bit service class UUIDs.
- `ESP_BLE_AD_TYPE_128SRV_CMPL (x07)`
- `ESP_BLE_AD_TYPE_NAME_SHORT (0x08)` – Shortened local name.

- `ESP_BLE_AD_TYPE_NAME_CMPL` (0x09) – Complete local name.
- `ESP_BLE_AD_TYPE_TX_PWR` (0x0A)
- `ESP_BLE_AD_TYPE_DEV_CLASS` (0x0D)
- `ESP_BLE_AD_TYPE_SM_TK` (0x10)
- `ESP_BLE_AD_TYPE_SM_OOB_FLAG` (0x11)
- `ESP_BLE_AD_TYPE_INT_RANGE` (0x12)
- `ESP_BLE_AD_TYPE_SOL_SRV_UUID` (0x14)
- `ESP_BLE_AD_TYPE_128SOL_SRV_UUID` (0x15)
- `ESP_BLE_AD_TYPE_SERVICE_DATA` (0x16)
- `ESP_BLE_AD_TYPE_PUBLIC_TARGET` (0x17)
- `ESP_BLE_AD_TYPE_RANDOM_TARGET` (0x18)
- `ESP_BLE_AD_TYPE_APPEARANCE` (0x19) – It is likely this conforms to the assigned numbers found here <https://www.bluetooth.com/specifications/gatt/viewer?attributeXmlFile=org.bluetooth.characteristic.gap.appearance.xml> and
- `ESP_BLE_AD_TYPE_ADV_INT` (0x1A)
- `ESP_BLE_AD_TYPE_32SOL_SRV_UUID` (0x1B)
- `ESP_BLE_AD_TYPE_32SERVICE_DATA` (0x1C)
- `ESP_BLE_AD_TYPE_128SERVICE_DATA` (0x1D)
- `ESP_BLE_AD_MANUFACTURER_SPECIFIC_TYPE` (0xFF) – Custom payload.

The `length` is the length of the advertised data.

Includes:

- `#include <esp_gap_ble_api.h>`

See also:

- GAP Advertising data
- `esp_ble_gap_register_callback`

### `esp_ble_tx_power_get`

```
esp_power_level_t esp_ble_tx_power_get(esp_ble_power_type_t power_type)
```

## esp\_ble\_tx\_power\_set

```
esp_err_t esp_ble_tx_power_set(  
    esp_ble_power_type_t power_type,  
    esp_power_level_t    power_level  
)
```

Set the transmission power level.

### power\_type

- ESP\_BLE\_PWR\_TYPE\_CONN\_HDL0
- ESP\_BLE\_PWR\_TYPE\_CONN\_HDL1
- ESP\_BLE\_PWR\_TYPE\_CONN\_HDL2
- ESP\_BLE\_PWR\_TYPE\_CONN\_HDL3
- ESP\_BLE\_PWR\_TYPE\_CONN\_HDL4
- ESP\_BLE\_PWR\_TYPE\_CONN\_HDL5
- ESP\_BLE\_PWR\_TYPE\_CONN\_HDL6
- ESP\_BLE\_PWR\_TYPE\_CONN\_HDL7
- ESP\_BLE\_PWR\_TYPE\_CONN\_HDL8
- ESP\_BLE\_PWR\_TYPE\_ADV
- ESP\_BLE\_PWR\_TYPE\_SCAN
- ESP\_BLE\_PWR\_TYPE\_DEFAULT
- ESP\_BLE\_PWR\_TYPE\_NUM

### power\_level

- ESP\_PWR\_LVL\_N14
- ESP\_PWR\_LVL\_N11
- ESP\_PWR\_LVL\_N8
- ESP\_PWR\_LVL\_N5
- ESP\_PWR\_LVL\_N2
- ESP\_PWR\_LVL\_P1
- ESP\_PWR\_LVL\_P4
- ESP\_PWR\_LVL\_P7

### **esp\_bluedroid\_deinit**

Disable and release all resources for bluetooth.

```
esp_err_t esp_bluedroid_deinit(void);
```

Includes:

- `#include <esp_bt_main.h>`

### **esp\_bluedroid\_disable**

Disable bluetooth.

```
esp_err_t esp_bluedroid_disable(void)
```

Includes:

- `#include <esp_bt_main.h>`

### **esp\_bluedroid\_enable**

Enable bluetooth.

```
esp_err_t esp_bluedroid_enable(void)
```

Includes:

- `#include <esp_bt_main.h>`

### **esp\_bluedroid\_init**

Initialize and enable bluetooth resources.

```
esp_err_t esp_bluedroid_init(void)
```

Includes:

- `#include <esp_bt_main.h>`

### **esp\_bt\_controller\_deinit**

```
esp_err_t esp_bt_controller_deinit(void)
```

Includes:

- `#include <bt.h>`

### **esp\_bt\_controller\_disable**

`esp_err_t esp_bt_controller_disable(void)`

Includes:

- `#include <bt.h>`

### **esp\_bt\_controller\_enable**

Enable the bluetooth controller.

`esp_err_t esp_bt_controller_enable(esp_bt_mode_t mode)`

The value of `mode` can be one of:

- `ESP_BT_MODE_ILDE` – Not run.
- `ESP_BT_MODE_BLE` – BLE mode.
- `ESP_BT_MODE_CLASSIC_BT` – Classic mode.
- `ESP_BT_MODE_BTDM` – Dual mode.

Note: Currently only `ESP_BT_MODE_BTDM` is supported.

Includes:

- `#include <bt.h>`

### **esp\_bt\_controller\_get\_status**

`esp_bt_controller_status_t esp_bt_controller_get_status(void)`

Includes:

- `#include <bt.h>`

### **esp\_bt\_controller\_init**

`esp_err_t esp_bt_controller_init(esp_bt_controller_config_t* cfg)`

Includes:

- `#include <bt.h>`

Typically, we will code this as:

```
esp_bt_controller_config_t bt_cfg = BT_CONTROLLER_INIT_CONFIG_DEFAULT();  
ret = esp_bt_controller_init(&bt_cfg);
```

Includes:

- `#include <bt.h>`

### **esp\_bt\_controller\_mem\_release**

```
esp_err_t esp_bt_controller_mem_release(esp_bt_mode_t mode)
```

The value of `mode` can be one of:

- `ESP_BT_MODE_ILDE` – Not run.
- `ESP_BT_MODE_BLE` – BLE mode.
- `ESP_BT_MODE_CLASSIC_BT` – Classic mode.
- `ESP_BT_MODE_BTDM` – Dual mode.

Includes:

- `#include <bt.h>`

### **esp\_bt\_dev\_get\_address**

Get the bluetooth device address.

```
const uint8_t* esp_bt_dev_get_address(void)
```

Includes:

- `#include <esp_bt_device.h>`

### **esp\_bt\_dev\_set\_device\_name**

Set the name of the bluetooth device.

```
esp_err_t esp_bt_dev_set_device_name(const char* name)
```

Includes:

- `#include <esp_bt_device.h>`

### **esp\_vhci\_host\_check\_send\_available**

```
bool esp_vhci_host_check_send_available()
```

Includes:

- `#include <bt.h>`

### **esp\_vhci\_host\_register\_callback**

```
void esp_vhci_host_register_callback(const esp_vhci_host_callback_t *callback)
```

Includes:

- `#include <bt.h>`

### **esp\_vhci\_host\_send\_packet**

```
void esp_vhci_host_send_packet(uint8_t *data, uint16_t len)
```

Includes:

- `#include <bt.h>`

## **ESP MQTT**

We configure a client by passing in a populated reference to an `esp_mqtt_client_config_t` structure.

This structure contains:

- `mqtt_event_callback_t event_handle` – Event handler.
- `const char* host`
- `const char* uri`
- `uint32_t port`
- `const char* client_id`
- `const char* username` – User name for authentication.
- `const char* password` – Password for authentication.
- `const char* lwt_topic` – Last will topic.
- `const char* lwt_msg` – Last will message.
- `int lwt_qos` – Last will QOS.
- `int lwt_retain` – Last will retain.
- `int lwt_msg_len` – Last will message length.
- `int disable_clean_session`
- `int keepalive`
- `bool disable_auto_reconnect`

- `void* user_context` – A pointer to data that is passed to all event functions.
- `int task_prio` – The task priority. Default is 5.
- `int task_stack` – The size of the processing stack.
- `int buffer_size` – Size of the MQTT send/receive buffer. Default is 1024.
- `const char* cert_pem` – CERT data in PEM format.
- `esp_mqtt_transport_t transport` – The transport to use. One of:
  - `MQTT_TRANSPORT_UNKNOWN`
  - `MQTT_TRANSPORT_OVER_TCP`
  - `MQTT_TRANSPORT_OVER_SSL`
  - `MQTT_TRANSPORT_OVER_WS`
  - `MQTT_TRANSPORT_OVER_WSS`

We register an event handler. The handler has the following signature:

```
esp_err_t mqtt_event_handler(esp_mqtt_event_handle_t event)
```

The event structure contains:

- `esp_mqtt_event_t event_id` – The type of event.
  - `MQTT_EVENT_ERROR`
  - `MQTT_EVENT_CONNECTED` – A connection was successful.
  - `MQTT_EVENT_DISCONNECTED`
  - `MQTT_EVENT_SUBSCRIBED` – A subscription was successful.
  - `MQTT_EVENT_UNSUBSCRIBED`
  - `MQTT_EVENT_PUBLISHED` – A message was published.
  - `MQTT_EVENT_DATA` – A new subscribed message was received.
- `esp_mqtt_client_handle_t client` – Always populated.
- `void* user_context` – A pointer to data that may have been supplied in `esp_mqtt_client_config_t`.
- `char* data` – The payload data of the message.
- `int data_len` – The length of the data received.
- `int total_data_len` – The length of the total message.



- `int current_data_offset` – Where are we in the message.
- `char* topic` – The identity of the topic.
- `int topic_len` – The length of the topic in bytes.
- `int msg_id` – The identity of the received message.

### **esp\_mqtt\_client\_destroy**

```
esp_err_t esp_mqtt_client_destroy(esp_mqtt_client_handle_t client)
```

### **esp\_mqtt\_client\_init**

```
esp_mqtt_client_handle_t esp_mqtt_client_init(
    const esp_mqtt_client_config_t* config)
```

#### **Includes:**

- `#include <mqtt_client.h>`

### **esp\_mqtt\_client\_publish**

```
int esp_mqtt_client_publish(
    esp_mqtt_client_handle_t client,
    const char* topic,
    const char* data,
    int len,
    int qos,
    int retain)
```

- `client` – The handle that was returned from a previous call to `esp_mqtt_client_init()`.
- `topic` – The topic to publish upon.
- `data` – The payload of the message.
- `len` – The length of the payload.
- `qos` – The quality of service. This should be 0, 1 or 2.
- `retain` – Should the message be retained.

#### **Includes:**

- `#include <mqtt_client.h>`

### **esp\_mqtt\_client\_set\_uri**

```
esp_err_t esp_mqtt_client_set_uri(  
    esp_mqtt_client_handle_t client,  
    const char* uri)
```

Includes:

- `#include <mqtt_client.h>`

### **esp\_mqtt\_client\_start**

```
esp_err_t esp_mqtt_client_start(esp_mqtt_client_handle_t client)
```

Includes:

- `#include <mqtt_client.h>`

See also:

- `esp_mqtt_client_stop`

### **esp\_mqtt\_client\_stop**

```
esp_err_t esp_mqtt_client_stop(esp_mqtt_client_handle_t client)
```

Includes:

- `#include <mqtt_client.h>`

See also:

- `esp_mqtt_client_start`

### **esp\_mqtt\_client\_subscribe**

```
esp_err_t esp_mqtt_client_subscribe(  
    esp_mqtt_client_handle_t client,  
    const char* topic,  
    int qos)
```

Includes:

- `#include <mqtt_client.h>`

See also:

- `esp_mqtt_client_unsubscribe`

### **esp\_mqtt\_client\_unsubscribe**

```
esp_err_t esp_mqtt_client_unsubscribe(  
    esp_mqtt_client_handle_t client,  
    const char* topic)
```

Includes:

- `#include <mqtt_client.h>`

See also:

- `esp_mqtt_client_subscribe`

## Mesh

### `esp_mesh_allow_root_conflicts`

```
esp_err_t esp_mesh_allow_root_conflicts(const bool allowed)
```

Includes:

- `#include <esp_mesh.h>`

### `esp_mesh_available_txupQ_num`

```
int esp_mesh_available_txupQ_num(  
    const mesh_addr_t* addr,  
    uint32_t* xseqno_in)
```

Includes:

- `#include <esp_mesh.h>`

### `esp_mesh_deinit`

```
esp_err_t esp_mesh_deinit(void)
```

Stop mesh processing and release internal resources. Effectively undoes the `esp_mesh_init()`.

Includes:

- `#include <esp_mesh.h>`

See also:

- `esp_mesh_init`

### `esp_mesh_delete_group_id`

```
esp_err_t esp_mesh_delete_group_id(  
    const mesh_addr_t* addr,  
    const int num)
```

Includes:

- `#include <esp_mesh.h>`

### **esp\_mesh\_get\_ap\_assoc\_expire**

`int esp_mesh_get_ap_assoc_expire(void)`

Includes:

- `#include <esp_mesh.h>`

### **esp\_mesh\_get\_ap\_authmode**

`wifi_auth_mode_t esp_mesh_get_ap_authmode(void)`

Includes:

- `#include <esp_mesh.h>`

### **esp\_mesh\_get\_ap\_connections**

`int esp_mesh_get_ap_connections(void)`

Includes:

- `#include <esp_mesh.h>`

### **esp\_mesh\_get\_capacity\_num**

`int esp_mesh_get_capacity_num(void)`

Includes:

- `#include <esp_mesh.h>`

### **esp\_mesh\_get\_config**

`esp_err_t esp_mesh_get_config(mesh_cfg_t* config)`

Includes:

- `#include <esp_mesh.h>`

### **esp\_mesh\_get\_group\_list**

`esp_err_t esp_mesh_get_group_list(mesh_addr_t* addr, const int num)`

Includes:

- `#include <esp_mesh.h>`

### **esp\_mesh\_get\_group\_num**

`int esp_mesh_get_group_num(void)`

Includes:

- `#include <esp_mesh.h>`

### **esp\_mesh\_get\_id**

`esp_err_t esp_mesh_get_id(mesh_addr_t* id)`

Includes:

- `#include <esp_mesh.h>`

### **esp\_mesh\_get\_ie\_crypto\_key**

`esp_err_t esp_mesh_get_ie_crypto_key(uint8_t* key, int len)`

Includes:

- `#include <esp_mesh.h>`

### **esp\_mesh\_get\_layer**

`int esp_mesh_get_layer(void)`

Includes:

- `#include <esp_mesh.h>`

### **esp\_mesh\_get\_max\_layer**

`int esp_mesh_get_max_layer(void)`

Includes:

- `#include <esp_mesh.h>`

### **esp\_mesh\_get\_parent\_bssid**

esp\_err\_t esp\_mesh\_get\_parent\_bssid(mesh\_addr\_t \*bssid)

Includes:

- #include <esp\_mesh.h>

### **esp\_mesh\_get\_root\_healing\_delay**

int esp\_mesh\_get\_root\_healing\_delay(void)

Includes:

- #include <esp\_mesh.h>

### **esp\_mesh\_get\_router**

esp\_err\_t esp\_mesh\_get\_router(mesh\_router\_t \*router)

Includes:

- #include <esp\_mesh.h>

### **esp\_mesh\_get\_routing\_table**

esp\_err\_t esp\_mesh\_get\_routing\_table(  
mesh\_addr\_t\* mac,  
int len,  
int\* size)

Includes:

- #include <esp\_mesh.h>

### **esp\_mesh\_get\_routing\_table\_size**

int esp\_mesh\_get\_routing\_table\_size(void)

Includes:

- #include <esp\_mesh.h>

### **esp\_mesh\_get\_rx\_pending**

esp\_err\_t esp\_mesh\_get\_rx\_pending(mesh\_rx\_pending\_t\* pending)

Includes:

- #include <esp\_mesh.h>

### **esp\_mesh\_get\_self\_organized**

bool esp\_mesh\_get\_self\_organized(void)

Includes:

- #include <esp\_mesh.h>

### **esp\_mesh\_get\_total\_node\_num**

int esp\_mesh\_get\_total\_node\_num(void)

Includes:

- #include <esp\_mesh.h>

### **esp\_mesh\_get\_tx\_pending**

esp\_err\_t esp\_mesh\_get\_tx\_pending(mesh\_tx\_pending\_t\* pending)

Includes:

- #include <esp\_mesh.h>

### **esp\_mesh\_get\_type**

mesh\_type\_t esp\_mesh\_get\_type(void)

Includes:

- #include <esp\_mesh.h>

### **esp\_mesh\_get\_vote\_percentage**

float esp\_mesh\_get\_vote\_percentage(void)

Includes:

- #include <esp\_mesh.h>

### **esp\_mesh\_get\_xon\_qsize**

int esp\_mesh\_get\_xon\_qsize(void)

Includes:

- `#include <esp_mesh.h>`

### **esp\_mesh\_init**

```
esp_err_t esp_mesh_init()
```

Initialize the mesh environment and internal state. Must not be called before WiFi is started.

Includes:

- `#include <esp_mesh.h>`

See also:

- `esp_mesh_deinit`

### **esp\_mesh\_is\_my\_group**

```
bool esp_mesh_is_my_group(const mesh_addr_t* addr)
```

Includes:

- `#include <esp_mesh.h>`

### **esp\_mesh\_is\_root**

```
bool esp_mesh_is_root(void)
```

Includes:

- `#include <esp_mesh.h>`

### **esp\_mesh\_post\_toDS\_state**

```
esp_err_t esp_mesh_post_toDS_state(const bool reachable)
```

Includes:

- `#include <esp_mesh.h>`

### **esp\_mesh\_recv**

```
esp_err_t esp_mesh_recv(  
    mesh_addr_t* from,  
    mesh_data_t* data,  
    int          timeout_ms,  
    int*         flag,
```



```
mesh_opt_t  opt[],
int         opt_count)
```

- from
- data
- timeout\_ms
  - 0 – no wait
  - portMAX\_DELAY – wait forever
- flag
  - MESH\_DATA\_FROMDS
  - MESH\_DATA\_TODS
- opt
  - MESH\_OPT\_RECV\_DS\_ADDR
- opt\_count

Includes:

- #include <esp\_mesh.h>

### esp\_mesh\_recv\_toDS

```
esp_err_t esp_mesh_recv_toDS(
    mesh_addr_t* from,
    mesh_addr_t* to,
    mesh_data_t* data,
    int         timeout_ms,
    int*        flag,
    mesh_opt_t  opt[],
    int         opt_count)
```

- from
- to
- data
- timeout\_ms
- flag
  - MESH\_DATA\_TODS
- opt

- `opt_count`

Includes:

- `#include <esp_mesh.h>`

### **esp\_mesh\_send**

```
esp_err_t esp_mesh_send(  
    const mesh_addr_t* to,  
    const mesh_data_t* data,  
    const int          flag,  
    const mesh_opt_t  opt[],  
    const int          opt_count)
```

Send a packet of data over the mesh network.

- `to` - The address of the destination of the message. To send to root, supply `NULL`.
- `data`
- `flag` – Flags that affect processing. A bit-wise or of:
  - `MESH_DATA_P2P`
  - `MESH_DATA_TODS`
  - `MESH_DATA_FROMDS`
  - `MESH_DATA_NONBLOCK`
  - `MESH_DATA_DROP`
- `opt`
  - `MESH_OP_SEND_GROUP`
  - `MESH_OP_RECV_DS_ADDR`
- `opt_count`

Includes:

- `#include <esp_mesh.h>`

### **esp\_mesh\_set\_ap\_assoc\_expire**

```
esp_err_t esp_mesh_set_ap_assoc_expire(const int seconds)
```

Includes:

- `#include <esp_mesh.h>`

### **esp\_mesh\_set\_ap\_authmode**

esp\_err\_t esp\_mesh\_set\_ap\_authmode(const wifi\_auth\_mode\_t authmode)

Includes:

- #include <esp\_mesh.h>

### **esp\_mesh\_set\_ap\_connections**

esp\_err\_t esp\_mesh\_set\_ap\_connections(const int connections)

Includes:

- #include <esp\_mesh.h>

### **esp\_mesh\_set\_ap\_password**

esp\_err\_t esp\_mesh\_set\_ap\_password(  
const uint8\_t\* pwd,  
const int len)

Includes:

- #include <esp\_mesh.h>

### **esp\_mesh\_set\_capacity\_num**

esp\_err\_t esp\_mesh\_set\_capacity\_num(int num)

Includes:

- #include <esp\_mesh.h>

### **esp\_mesh\_set\_config**

esp\_err\_t esp\_mesh\_set\_config(const mesh\_cfg\_t\* config)

Includes:

- #include <esp\_mesh.h>

### **esp\_mesh\_set\_event\_cb**

esp\_err\_t esp\_mesh\_set\_event\_cb(const mesh\_event\_cb\_t event\_cb)

Includes:

- `#include <esp_mesh.h>`

### **esp\_mesh\_set\_group\_id**

```
esp_err_t esp_mesh_set_group_id(  
    const mesh_addr_t* addr,  
    const int num)
```

Includes:

- `#include <esp_mesh.h>`

### **esp\_mesh\_set\_id**

```
esp_err_t esp_mesh_set_id(const mesh_addr_t* id)
```

This should be called between `esp_mesh_init()` and `esp_mesh_start()`.

Includes:

- `#include <esp_mesh.h>`

### **esp\_mesh\_set\_ie\_crypto\_funcs**

```
esp_err_t esp_mesh_set_ie_crypto_funcs(  
    const mesh_crypto_funcs_t* crypto_funcs)
```

Includes:

- `#include <esp_mesh.h>`

### **esp\_mesh\_set\_ie\_crypto\_key**

```
esp_err_t esp_mesh_set_ie_crypto_key(const uint8_t* key, int len)
```

Includes:

- `#include <esp_mesh.h>`

### **esp\_mesh\_set\_max\_layer**

```
esp_err_t esp_mesh_set_max_layer(const int max_layer)
```

Includes:

- `#include <esp_mesh.h>`

### **esp\_mesh\_set\_root\_healing\_delay**

`esp_err_t esp_mesh_set_root_healing_delay(int delay_ms)`

Includes:

- `#include <esp_mesh.h>`

### **esp\_mesh\_set\_router**

`esp_err_t esp_mesh_set_router(const mesh_router_t* router)`

Includes:

- `#include <esp_mesh.h>`

### **esp\_mesh\_set\_self\_organized**

`esp_err_t esp_mesh_set_self_organized(const bool enable)`

Includes:

- `#include <esp_mesh.h>`

### **esp\_mesh\_set\_type**

`esp_err_t esp_mesh_set_type(const mesh_type_t type)`

Includes:

- `#include <esp_mesh.h>`

### **esp\_mesh\_set\_vote\_percentage**

`esp_err_t esp_mesh_set_vote_percentage(const float percentage)`

Includes:

- `#include <esp_mesh.h>`

### **esp\_mesh\_set\_xon\_qsize**

`esp_err_t esp_mesh_set_xon_qsize(int qsize)`

Includes:

- `#include <esp_mesh.h>`

## **esp\_mesh\_start**

`esp_err_t esp_mesh_start(void)`

Start the mesh executing. Should not be called before calling `esp_mesh_init()` and `esp_mesh_set_config()`.

Includes:

- `#include <esp_mesh.h>`

See also:

- `esp_mesh_init`
- `esp_mesh_set_config`
- `esp_mesh_stop`

## **esp\_mesh\_stop**

`esp_err_t esp_mesh_stop(void)`

Stop the mesh from processing. The opposite of `esp_mesh_start()`.

Includes:

- `#include <esp_mesh.h>`

See also:

- `esp_mesh_start`

## **esp\_mesh\_waive\_root**

`esp_err_t esp_mesh_waive_root(const mesh_vote_t* vote, const int reason)`

Includes:

- `#include <esp_mesh.h>`

## **Upgrade APIs**

### **system\_upgrade\_flag\_check**

Retrieve the upgrade status flag.

`uint8 system_upgrade_flag_check()`

The returned value will be one of:

- `UPGRADE_FLAG_IDLE` –
- `UPGRADE_FLAG_START` –

- UPGRADE\_FLAG\_FINISH –

### **system\_upgrade\_flag\_set**

Set the upgrade status flag.

```
void system_upgrade_flag_set(uint8 flag)
```

The flag can be one of:

- UPGRADE\_FLAG\_IDLE –
- UPGRADE\_FLAG\_START –
- UPGRADE\_FLAG\_FINISH –

### **system\_upgrade\_reboot**

Reboot the ESP8266 and run the new firmware.

```
void system_upgrade_reboot()
```

### **system\_upgrade\_start**

Start downloading the new firmware from the server.

```
bool system_upgrade_start(struct upgrade_server_info *server)
```

The server parameter is a structure ...

### **system\_upgrade\_userbin\_check**

Determine which of the two possible firmware images can be upgraded.

```
uint8 system_upgrade_userbin_check()
```

The result will be either UPGRADE\_FW\_BIN1 or UPGRADE\_FW\_BIN2.

## **Smart config APIs**

### **smartconfig\_start**

```
bool smartconfig_start(sc_callback_t cb, uint8 log)
```

## **smartconfig\_stop**

`bool smartconfig_stop(void)`

## **SNTP API**

Handle Simple Network Time Protocol requests.

See also:

- Working with SNTP

## **sntp\_enabled**

Determine whether or not SNTP is enabled.

`u8_t sntp_enabled()`

Includes:

- `#include <apps/sntp/sntp.h>`

## **sntp\_getoperatingmode**

Retrieve the current operating mode.

`u8_t sntp_getoperatingmode()`

The operating mode returned can be one if:

- `SNTP_OPMODE_POLL` – This is the default.
- `SNTP_OPMODE_LISTENONLY` –

Includes:

- `#include <apps/sntp/sntp.h>`

## **sntp\_getserver**

`ip_addr_t sntp_getserver(u8_t idx)`

Includes:

- `#include <apps/sntp/sntp.h>`

## **sntp\_getservername**

Get the hostname of a target SNTP server.



```
char *sntp_getservername(u8_t index)
```

Retrieve the host name of a specific SNTP server that was previously registered.

The `index` parameter is the index of an SNTP server that was previously set. It may be either 0, 1 or 2.

The return from this function is a NULL terminated string.

Includes:

- `#include <apps/sntp/sntp.h>`

See also:

- Working with SNTP

### **sntp\_init**

```
void sntp_init()
```

Initialize the SNTP functions. Prior to calling this function, set the operating mode and server name.

Includes:

- `#include <apps/sntp/sntp.h>`

See also:

- Working with SNTP
- `sntp_stop`

### **sntp\_servermode\_dhcp**

Enable use of DHCP for SNTP server location.

```
sntp_servermode_dhcp(int setServersFromDhcp)
```

The `setServersFromDhcp` is a flag that should be 1 or 0. If set to 1, then we are requesting that the servers to be used for SNTP should be requested from the DHCP server.

Includes:

- `#include <apps/sntp/sntp.h>`

### **sntp\_setoperatingmode**

Set the operating mode of SNTP access.

```
void sntp_setoperatingmode(u8_t operatingMode)
```

Operating mode can be one of:

- `SNTP_OPMODE_POLL` – This is the default.
- `SNTP_OPMODE_LISTENONLY` –

Includes:

- `#include <apps/sntp/sntp.h>`

### **sntp\_setserver**

Set the address of an SNTP server.

```
void sntp_serverserver(u8_t index, ip_addr_t *addr)
```

Set the address of one of the three possible SNTP servers to be used.

The `index` parameter must be either 0, 1 or 2 and specifies which of the SNTP server slots is to be set.

The `addr` parameter is the IP address of the SNTP server to be recorded.

Includes:

- `#include <apps/sntp/sntp.h>`

See also:

- [Working with SNTP](#)

### **sntp\_setservername**

Set the host name of a target SNTP server.

```
void sntp_setservername(u8_t index, char *server)
```

Specify an SNTP server by its host name.

The `index` parameter is the index of an SNTP server to be set. It may be either 0, 1 or 2.

The `server` parameter is a NULL terminated string that names the host that is an SNTP server instance.

Includes:

- `#include <apps/sntp/sntp.h>`

See also:

- [Working with SNTP](#)

## sntp\_stop

Stop SNTP processing.

```
void sntp_stop()
```

Includes:

- `#include <apps/sntp/sntp.h>`

See also:

- Working with SNTP

## Generic TCP/UDP APIs

### ipaddr\_addr

Build a TCP/IP address from a dotted decimal string representation.

```
uint32 ipaddr_addr(char *addressString)
```

Return an IP address (4 byte) value from a dotted decimal string representation supplied in the `addressString` parameter. Note that the `uint32` type is **not** assignable to the addresses in an `esp_tcp` or `esp_udp` structure. Instead we have to use a local variable and then copy the content. For example:

```
uint32 addr = ipaddr_addr(server);  
memcpy(m_tcp.remote_ip, &addr, 4);
```

### IP4\_ADDR

Set the value of a variable to an IP address from its decimal representation.

```
IP4_ADDR(struct ip_addr * addr, a, b, c, d)
```

The `addr` parameter is a pointer to storage to hold an IP address. This may be an instance of `struct ip_addr`, a `uint32`, `uint8[4]`. It must be cast to a pointer to a `struct ip_addr` if not already of that type.

The parameters `a`, `b`, `c` and `d` are the parts of an IP address if it were written in dotted decimal notation.

Includes:

- `ip_addr.h`

See also:

- Error: Reference source not found

## IP2STR

Generate four int values used in a `printf` statement

```
IP2STR(ip_addr_t *address)
```

This is a macro which takes a pointer to an IP address and returns four comma separated decimal values representing the 4 bytes of an IP address. This is commonly used in code such as:

```
printf("%d.%d.%d.%d", IP2STR(&addr));
```

The macro `IPSTR` can be used in place of 4 `"%d"` macros:

```
printf(IPSTR, IP2STR(&addr));
```

Includes:

- `tcpip_adapter.h`

See also:

- `tcpip_adapter_get_ip_info`

## MAC2STR

Generate 6 values for a `printf` format.

```
MAC2STR(char *[6])
```

Use this in conjunction with the `MACSTR` macro. Here is an example:

```
char mac[6];  
...  
printf(MACSTR, MAC2STR(mac));
```

Includes:

- `rom/ets_sys.h`

## TCP Adapter APIs

The TCP/IP adapter.

### `tcpip_adapter_ap_input`

Receive low level data.

```
esp_err_t tcpip_adapter_ap_input(  
    void *buffer,  
    uint16_t len,  
    void *eb)
```

This function is exposed but somewhat of a mystery. It appears to be related to getting data from the WiFi layer to be supplied to the TCP/IP layer but we have no knowledge about when or how it might be used.

Includes:

- `#include <tcpip_adapter.h>`

### **tcpip\_adapter\_ap\_start**

```
esp_err_t tcpip_adapter_ap_start(uint8_t *mac, tcpip_adapter_ip_info_t *ip_info)
```

### **tcpip\_adapter\_create\_ip6\_linklocal**

```
esp_err_t tcpip_adapter_create_ip6_linklocal(tcpip_adapter_if_t tcpip_if)
```

### **tcpip\_adapter\_dhcpc\_get\_status**

Get the status of the DHCP client subsystem.

```
esp_err_t tcpip_adapter_dhcpc_get_status(  
    tcpip_adapter_if_t tcpip_if,  
    tcpip_adapter_dhcp_status_t *status)
```

The `tcpip_if` is the interface is one of the following:

- `TCPIP_ADAPTER_IF_STA` – Station interface.
- `TCPIP_ADAPTER_IF_AP` – Access point interface.

The status can be one of:

- `TCPIP_ADAPTER_DHCP_STARTED` – DHCP client has started for this interface.
- `TCPIP_ADAPTER_DHCP_STOPPED` – DHCP client has stopped for this interface.

Includes:

- `#include <tcpip_adapter.h>`

### **tcpip\_adapter\_dhcpc\_option**

```
esp_err_t tcpip_adapter_dhcpc_option(  
    tcpip_adapter_option_mode_t opt_op,  
    tcpip_adapter_option_id_t opt_id,  
    void *opt_val, uint32_t opt_len)
```

The `tcpip_if` is the interface is one of the following:

- TCPIP\_ADAPTER\_IF\_STA – Station interface.
- TCPIP\_ADAPTER\_IF\_AP – Access point interface.

The `opt_op` can be one of:

- TCPIP\_ADAPTER\_OP\_SET – Set the option.
- TCPIP\_ADAPTER\_OP\_GET – Get the option.

The `opt_id` can be one of:

- TCPIP\_ADAPTER\_ROUTER\_SOLICITATION\_ADDRESS
- TCPIP\_ADAPTER\_REQUESTED\_IP\_ADDRESS
- TCPIP\_ADAPTER\_IP\_ADDRESS\_LEASE\_TIME
- TCPIP\_ADAPTER\_IP\_REQUEST\_RETRY\_TIME

Includes:

- `#include <tcpip_adapter.h>`

### **tcpip\_adapter\_dhcp\_start**

Start the DHCP client on the specified interface.

```
esp_err_t tcpip_adapter_dhcp_start(tcpip_adapter_if_t tcpip_if)
```

The `tcpip_if` is the interface is one of the following:

- TCPIP\_ADAPTER\_IF\_STA – Station interface.
- TCPIP\_ADAPTER\_IF\_AP – Access point interface.

### **tcpip\_adapter\_dhcp\_stop**

Stop the DHCP client on the specified interface.

```
esp_err_t tcpip_adapter_dhcp_stop(tcpip_adapter_if_t tcpip_if)
```

The `tcpip_if` is the interface is one of the following:

- TCPIP\_ADAPTER\_IF\_STA – Station interface.
- TCPIP\_ADAPTER\_IF\_AP – Access point interface.

Includes:

- `#include <tcpip_adapter.h>`

## tcpip\_adapter\_dhcps\_get\_status

Retrieve the status of the DHCP server subsystem.

```
esp_err_t tcpip_adapter_dhcps_get_status(  
    tcpip_adapter_if_t tcpip_if,  
    tcpip_adapter_dhcp_status_t *status)
```

The `tcpip_if` is the interface is one of the following:

- `TCPIP_ADAPTER_IF_STA` – Station interface.
- `TCPIP_ADAPTER_IF_AP` – Access point interface.

The `status` parameter returns the possible states of the DHCP subsystem which are:

- `TCPIP_ADAPTER_DHCP_INIT` – Initial state.
- `TCPIP_ADAPTER_DHCP_STARTED` – The DHCP service is running.
- `TCPIP_ADAPTER_DHCP_STOPPED` – The DHCP service is stopped.

Includes:

- `#include <tcpip_adapter.h>`

## tcpip\_adapter\_dhcps\_option

Set or get the options for the DHCP server

```
esp_err_t tcpip_adapter_dhcps_option(  
    tcpip_adapter_option_mode_t optMode,  
    tcpip_adapter_option_id_t optId,  
    void* opt_val,  
    uint32_t opt_len)
```

The `optMode` defines whether we are getting or setting an option. The possible values are:

- `TCPIP_ADAPTER_OP_SET` – Used to set an option.
- `TCPIP_ADAPTER_OP_GET` – Used to get an option.

The `optId` defines the option being set or retrieved. The currently defined values are:

- `TCPIP_ADAPTER_DOMAIN_NAME_SERVER` –
- `TCPIP_ADAPTER_ROUTER_SOLICITATION_ADDRESS` –

- TCPIP\_ADAPTER\_REQUESTED\_IP\_ADDRESS –
- TCPIP\_ADAPTER\_IP\_ADDRESS\_LEASE\_TIME –
- TCPIP\_ADAPTER\_IP\_REQUEST\_RETRY\_TIME –

For setting the address range of available IP addresses/network when being an access point, we appear to be able to perform the following:

```
tcpip_adapter_dhcps_stop(TCPIP_ADAPTER_IF_AP);
dhcps_lease_t optValue;
optValue.enable = true;
optValue.start_ip = // Start IP Address
optValue.end_ip = // End IP Address
tcpip_adapter_dhcps_option(
    TCPIP_ADAPTER_OP_SET,
    TCPIP_ADAPTER_REQUESTED_IP_ADDRESS,
    &optValue, sizeof(optValue));
tcpip_adapter_dhcps_start(TCPIP_ADAPTER_IF_AP);
```

Includes:

- #include <tcpip\_adapter.h>

### tcpip\_adapter\_dhcps\_start

Start the DHCP server on the specified interface.

```
esp_err_t tcpip_adapter_dhcps_start(tcpip_adapter_if_t tcpip_if)
```

The `tcpip_if` is the interface is one of the following:

- TCPIP\_ADAPTER\_IF\_STA – Station interface.
- TCPIP\_ADAPTER\_IF\_AP – Access point interface.

Includes:

- #include <tcpip\_adapter.h>

### tcpip\_adapter\_dhcps\_stop

Stop the DHCP server on the specified interface.

```
esp_err_t tcpip_adapter_dhcps_stop(tcpip_adapter_if_t tcpip_if)
```

The `tcpip_if` is the interface is one of the following:



- TCPIP\_ADAPTER\_IF\_STA – Station interface.
- TCPIP\_ADAPTER\_IF\_AP – Access point interface.

Includes:

- `#include <tcpip_adapter.h>`

### **tcpip\_adapter\_down**

Stop the TCP/IP interface.

```
esp_err_t tcpip_adapter_down(tcpip_adapter_if_t tcpip_if)
```

The `tcpip_if` is the interface is one of the following:

- TCPIP\_ADAPTER\_IF\_STA – Station interface.
- TCPIP\_ADAPTER\_IF\_AP – Access point interface.

### **tcpip\_adapter\_eth\_input**

```
esp_err_t tcpip_adapter_eth_input(void *buffer, uint16_t len, void *eb)
```

### **tcpip\_adapter\_eth\_start**

```
esp_err_t tcpip_adapter_eth_start(uint8_t *mac, tcpip_adapter_ip_info_t *ip_info);
```

### **tcpip\_adapter\_free\_sta\_list**

Release storage for the connected station list.

```
esp_err_t tcpip_adapter_free_sta_list(tcpip_adapter_sta_list_t *sta_list)
```

The storage was allocated with a call to `tcpip_adapter_get_sta_list()`.

Includes:

- `#include <tcpip_adapter.h>`

See also:

- `tcpip_adapter_get_sta_list`

### **tcpip\_adapter\_get\_esp\_if**

```
esp_interface_t tcpip_adapter_get_esp_if(void *dev)
```

### tcpip\_adapter\_get\_dns\_info

```
esp_err_t tcpip_adapter_get_dns_info(  
    tcpip_adapter_if_t tcpip_if,  
    tcpip_adapter_dns_type_t type,  
    tcpip_adapter_dns_info_t *dns)
```

### tcpip\_adapter\_get\_hostname

Get the host name of the interface.

```
esp_err_t tcpip_adapter_get_hostname(tcpip_adapter_if, const char **hostname)
```

The `tcpip_if` is the interface is one of the following:

- `TCPIP_ADAPTER_IF_STA` – Station interface.
- `TCPIP_ADAPTER_IF_AP` – Access point interface.

The `hostname` is the address of a pointer to a string. On successful return, the string pointer will now point to the null terminated string representing the host name of that interface.

Includes:

- `#include <tcpip_adapter.h>`

See also:

- `tcpip_adapter_set_hostname`

### tcpip\_adapter\_get\_ip\_info

Get the current IP address information.

```
esp_err_t tcpip_adapter_get_ip_info(  
    tcpip_adapter_if_t tcpip_if,  
    tcpip_adapter_ip_info_t* ipInfo)
```

The `tcpip_if` is the interface is one of the following:

- `TCPIP_ADAPTER_IF_STA` – Station interface.
- `TCPIP_ADAPTER_IF_AP` – Access point interface.

The `ipInfo` contains:

- `ip` – The ip address of the interface. 4 byte IP address.
- `netmask` – The network mask of the interface. 4 byte IP address.
- `gw` – The default gateway of the interface. 4 byte IP address.

Each of these fields is an instance of an `ip4_addr_t` which contains a field called `addr` which is an `uint32_t`.

Includes:

- `#include <tcpip_adapter.h>`

See also:

- IP2STR

### **tcpip\_adapter\_get\_ip6\_linklocal**

```
esp_err_t tcpip_adapter_get_ip6_linklocal(  
    tcpip_adapter_if_t tcpip_if,  
    ip6_addr_t*        if_ip6);
```

### **tcpip\_adapter\_get\_netif**

```
esp_err_t tcpip_adapter_get_netif(  
    tcpip_adapter_if_t tcpip_if,  
    void**             netif)
```

### **tcpip\_adapter\_get\_old\_ip\_info**

```
esp_err_t tcpip_adapter_get_old_ip_info(  
    tcpip_adapter_if_t tcpip_if,  
    tcpip_adapter_ip_info_t* ip_info)
```

### **tcpip\_adapter\_get\_sta\_list**

Populate a list of `tcpip_adapter_sta_list_t` from data.

```
esp_err_t tcpip_adapter_get_sta_list(  
    wifi_sta_list_t*    sta_info,  
    tcpip_adapter_sta_list_t** sta_list)
```

Populate a list of "`tcpip_adapter_sta_list_t`" from a list of "`wifi_sta_list_t`". The `tcpip_adapter_sta_list_t` contains:

```
    STAILQ_ENTRY(station_list) next  
        uint8_t [6] mac  
        ip4_addr_t ip
```

Here is an example of use:

```
wifi_sta_list_t *stations;  
ESP_ERROR_CHECK(esp_wifi_get_station_list(&stations));  
tcpip_adapter_sta_list_t *infoList;  
  
ESP_ERROR_CHECK(tcpip_adapter_get_sta_list(stations, &infoList));  
struct station_list *head = infoList;  
while(infoList != NULL) {  
    printf("mac: %.2x:%.2x:%.2x:%.2x:%.2x:%.2x " IPSTR " %d\n",  
        infoList->mac[0],infoList->mac[1],infoList->mac[2],
```

```

        infoList->mac[3],infoList->mac[4],infoList->mac[5],
        IP2STR(&(infoList->ip)),
        (uint32_t)(infoList->ip.addr));
    infoList = STAILQ_NEXT(infoList, next);
}
ESP_ERROR_CHECK(esp_adapter_free_sta_list(head));
ESP_ERROR_CHECK(esp_wifi_free_station_list());

```

#### Includes:

- `#include <tcpip_adapter.h>`

#### See also:

- `esp_wifi_get_station_list`

#### **tcpip\_adapter\_get\_wifi\_if**

```
wifi_interface_t tcpip_adapter_get_wifi_if(void *dev)
```

#### Includes:

- `#include <tcpip_adapter.h>`

#### **tcpip\_adapter\_init**

```
void tcpip_adapter_init(void)
```

#### Includes:

- `#include <tcpip_adapter.h>`

#### **tcpip\_adapter\_set\_dns\_info**

```
esp_err_t tcpip_adapter_set_dns_info(
    tcpip_adapter_if_t      tcpip_if,
    tcpip_adapter_dns_type_t type,
    tcpip_adapter_dns_info_t* dns)
```

#### **tcpip\_adapter\_set\_hostname**

Set the host name associated with the supplied interface.

```
esp_err_t tcpip_adapter_set_hostname(
    tcpip_adapter_if_t tcpip_if,
    char*               hostname)
```

The `tcpip_if` is the interface is one of the following:

- `TCPIP_ADAPTER_IF_STA` – Station interface.
- `TCPIP_ADAPTER_IF_AP` – Access point interface.

The `hostname` is the host name to be associated with the interface. The maximum size of the host name is `TCPIP_HOSTNAME_MAX_SIZE`.

Includes:

- `#include <tcpip_adapter.h>`

See also:

- `tcpip_adapter_get_hostname`

### `tcpip_adapter_set_ip_info`

Set our IP info.

```
esp_err_t tcpip_adapter_set_ip_info(  
    tcpip_adapter_if_t      tcpip_if,  
    tcpip_adapter_ip_info_t* ip_info)
```

Set the IP address of the adapter. If we are setting the station address, then the DHCP client must be already stopped. If we are setting the access point interface address, then the DHCP server must be already stopped.

The `tcpip_if` is the interface is one of the following:

- `TCPIP_ADAPTER_IF_STA` – Station interface.
- `TCPIP_ADAPTER_IF_AP` – Access point interface.

The `ipInfo` contains:

- `ip`
- `netmask`
- `gw`

Each of these fields are an `"ip4_addr_t"` which is itself a struct containing a field called `"addr"` which is a 32bit unsigned integer. One can set the value of such an address using the macro `"IP4_ADDR(ip4_addr_t *, int, int, int, int)"`.

For example:

```
tcpip_adapter_ip_info_t ipInfo;  
IP4_ADDR(&ipInfo.ip, 192,168,1,99);
```

Includes:

- `#include <tcpip_adapter.h>`

See also:

- The DHCP client

### tcpip\_adapter\_set\_old\_ip\_info

```
esp_err_t tcpip_adapter_set_old_ip_info(  
    tcpip_adapter_if_t      tcpip_if,  
    tcpip_adapter_ip_info_t* ip_info)
```

### tcpip\_adapter\_sta\_input

```
esp_err_t tcpip_adapter_sta_input(  
    void *buffer,  
    uint16_t len, void *eb)
```

#### Includes:

- `#include <tcpip_adapter.h>`

### tcpip\_adapter\_sta\_start

```
esp_err_t tcpip_adapter_sta_start(  
    uint8_t*      mac,  
    tcpip_adapter_ip_info_t* ip_info);
```

### tcpip\_adapter\_start

Start the TCP/IP interface.

```
esp_err_t tcpip_adapter_start(  
    tcpip_adapter_if_t      tcpip_if,  
    uint8_t*                mac,  
    tcpip_adapter_ip_info_t* ip_info)
```

The `tcpip_if` is the interface is one of the following:

- `TCPIP_ADAPTER_IF_STA` – Station interface.
- `TCPIP_ADAPTER_IF_AP` – Access point interface.

The `mac` contains the hardware mac address we are to use.

The `ipInfo` contains:

- `ip`
- `netmask`
- `gw`

#### Includes:

- `#include <tcpip_adapter.h>`

## tcpip\_adapter\_stop

```
esp_err_t tcpip_adapter_stop(tcpip_adapter_if_t tcpip_if)
```

The `tcpip_if` is the interface is one of the following:

- `TCPIP_ADAPTER_IF_STA` – Station interface.
- `TCPIP_ADAPTER_IF_AP` – Access point interface.

Includes:

- `#include <tcpip_adapter.h>`

## tcpip\_adapter\_up

Bring up the TCP/IP interface.

```
esp_err_t tcpip_adapter_up(tcpip_adapter_if_t tcpip_if)
```

The `tcpip_if` is the interface is one of the following:

- `TCPIP_ADAPTER_IF_STA` – Station interface.
- `TCPIP_ADAPTER_IF_AP` – Access point interface.

Includes:

- `#include <tcpip_adapter.h>`

## mdns

See also:

- Multicast Domain Name Systems

## mdns\_free

Stop and release resources for a previously initialized mDNS server.

```
void mdns_free(mdns_server_t* server)
```

The `server` parameter would have been previously created with a call to `mdns_init()`.

Includes:

- `#include <mdns.h>`

## mdns\_init

Initialize mDNS on an interface.

```
esp_err_t mdns_init(  
    tcpip_adapter_if_t tcpip_if,  
    mdns_server_t **server)
```

The `tcpip_if` is the interface on which mDNS is being initialized. The choices are `TCPIP_ADAPTER_IF_STA` or `TCPIP_ADAPTER_IF_AP`. The `server` is a pointer that is updated to point to an `mdns_server_t` data structure. That structure appears to be opaque.

Includes:

- `#include <mdns.h>`
- `#include <tcpip_adapter.h>`

## mdns\_query

Search for mDNS records of a given service or protocol.

```
size_t mdns_query(  
    mdns_server_t *server,  
    const char *service,  
    const char *proto,  
    uint32_t timeout)
```

If the `timeout` is 0, then `mdns_query_end()` must be called to explicitly end the search.

The return is the number of results found.

Includes:

- `#include <mdns.h>`

## mdns\_query\_end

Terminate a query where no timeout was specified.

```
size_t mdns_query_end(mdns_server_t *server)
```

Includes:

- `#include <mdns.h>`

## mdns\_result\_free

```
esp_err_t mdns_result_free(mdns_server_t *server)
```



Includes:

- `#include <mdns.h>`

### **mdns\_result\_get**

Get a specific result by index.

```
const mdns_result_t * mdns_result_get(
    mdns_server_t *server,
    size_t num)
```

Includes:

- `#include <mdns.h>`

### **mdns\_result\_get\_count**

Get the number of results currently in memory.

```
size_t mdns_result_get_count(mdns_server_t * server)
```

Includes:

- `#include <mdns.h>`

### **mdns\_service\_add**

Define a service we are advertizing when we are being an mDNS responder/server.

```
esp_err_t mdns_service_add(
    mdns_server_t *server,
    const char *service,
    const char *proto,
    uint16_t port)
```

The `server` is the value we got when we previously called `mdns_init()` to initialize ourselves as an mDNS responder.

The `port` is the port number on which our advertized service will be listening on for incoming connections.

We can call `mdns_service_remove()` to remove a service.

Includes:

- `#include <mdns.h>`

### **mdns\_service\_instance\_set**

```
esp_err_t mdns_service_instance_set(  
    mdns_server_t *server,  
    const char *service,  
    const char *proto,  
    const char *instance)
```

Includes:

- `#include <mdns.h>`

### **mdns\_service\_port\_set**

```
esp_err_t mdns_service_port_set(  
    mdns_server_t *server,  
    const char *service,  
    const char *proto, uint16_t port)
```

Includes:

- `#include <mdns.h>`

### **mdns\_service\_remove**

```
esp_err_t mdns_service_remove(  
    mdns_server_t *server,  
    const char *service,  
    const char *proto)
```

We call `mdns_service_add()` to add a service.

Includes:

- `#include <mdns.h>`

### **mdns\_service\_remove\_all**

```
esp_err_t mdns_service_remove_all(mdns_server_t *server)
```

Includes:

- `#include <mdns.h>`

### **mdns\_service\_txt\_set**

```
esp_err_t mdns_service_txt_set(  
    mdns_server_t *server,  
    const char *service,  
    const char *proto,
```

```
uint8_t num_items,  
const char **txt)
```

The `txt` is an array of strings where each entry is of the form "name=value".

Includes:

- `#include <mdns.h>`

### **mdns\_set\_hostname**

Set the host name of our mDNS server.

```
esp_err_t mdns_set_hostname(  
    mdns_server_t *server,  
    const char *hostname)
```

Includes:

- `#include <mdns.h>`

### **mdns\_set\_instance**

Set the instance name for our mDNS server.

```
esp_err_t mdns_set_instance(  
    mdns_server_t *server,  
    const char *instance)
```

Includes:

- `#include <mdns.h>`

## **OTA**

Over The Air (OTA) is the capability to save a new image in flash for subsequent execution on next boot/restart.

Loosely, imagine that we have two partitions in the partition table. Let us call them `ota_0` and `ota_1`. Let us assume that `ota_0` contains the image that we wish to run. When the ESP32 boots, it executes the application found in that partition.

An example partition table might be:

```
# Name,   Type, SubType, Offset,   Size, Flags  
nvs,     data, nvs,    0x9000, 0x4000  
otadata, data, ota,    0xd000, 0x2000  
phy_init, data, phy,    0xf000, 0x1000  
factory, 0,    0,      0x10000, 1M
```

```
ota_0, 0, ota_0, , 1M
ota_1, 0, ota_1, , 1M
```

Now let us assume we have a new version of our application we wish to deploy. One way would be to flash the ESP32 using the UART serial technology. However, this requires that we are able to attach the ESP32 to a PC using a UART connection. This is not a practical solution as the ESP32 may be in an embedded device such as a thermostat. The solution we wish to achieve is to download a new image via WiFi (over the air). We can't simply over-write the current image for two obvious reasons. The first is that the current image is actually the one running and responsible for performing the network retrieval of data. We can't assume that a running program can (or should) attempt to overwrite itself. The second problem is that something could go wrong with the data transmission and we would end up with a partially written replacement application which likely would not boot. This would result in a "bricked" device.

The solution is to load our new version in a completely separate (but equally sized) area of flash. If the download of the new application completes successfully, only then should we flag the new partition as the one we wish to boot from.

The configuration data which defines *which* partition we wish to use to load our application is known as the OTA Data Partition and is of type `data` (`ESP_PARTITION_TYPE_DATA`) with subtype `ota` (`ESP_PARTITION_SUBTYPE_DATA_OTA`). The size of the OTA Data Partition is 0x2000 bytes (8192 bytes).

Here is how we believe OTA works:

1. We call `esp_ota_begin()` to start the beginning of an OTA image write
2. We receive data that is part of the image
3. We call `esp_ota_write()` to write the data we just read
4. Go back to 2 while there is more of the image to receive over the network
5. We call `esp_ota_end()` to flag the end of the OTA image write
6. We call `esp_ota_set_boot_partition()` to specify which partition will be booted on next reboot. This will update the OTA data partition which records such information.

For those who are very technically minded, there may seem to be a puzzle related to how OTA works. To delve into this, let us review how an application is prepared for execution. First we write our source with an editor. Next we compile it to an object file that contains the compiled code but doesn't yet know where in memory it will live. Finally we link the object file (perhaps with other libraries) which produces an executable that has had all its unresolved symbols mapped and has provided the final execution locations for the code.

For example, upon compiling a source file which has a function called `foo()` within it, the linker may place `foo()` at address `0x400D0000`. With the compiled program ready, we copy that into flash at some flash offset corresponding to an OTA partition. For example, `0x20 0000`. If we now change the source code and recompile the application, we will have a second binary file that we also want to load into flash at a different OTA partition. Let us say that we load this into flash at `0x30 0000`. The puzzle starts to manifest here. When we compile and link code, we end up with the code thinking that it will execute at a specific location. For the first application, it thought it was going to run at `0x400D0000`. What of the second application? The answer is that the second application also believes it will run at the same address ranges. Obviously, only one application can possibly be at a given address range at any given time, how then does OTA work when we have two physically different binaries at two distinct areas of flash that both believe that they are going to execute at the same address? It works through a technology called memory mapping. Within an ESP32 there is a component called the memory mapping unit (MMU) that can map areas of flash memory to areas within the address space of the ESP32. For example, when the first program is to be run, the ESP32 will map flash at offset `0x20 0000` to the virtual memory at `0x400D0000`. If we subsequently boot and decide that the other application should run, the ESP32 will perform the same technique (mapping) but will now map flash at offset `0x30 0000` to the virtual memory at `0x400D0000`. The important idea to take away from this story is that areas of flash memory do not have fixed address in address space memory. Instead, the ESP32 can map flash to memory areas of our choosing.

See also:

- Partition table
- Partition API
- [ESP32 docs on OTA](#)

## esp\_ota\_begin

Begin the activity of flashing/loading the new image.

```
esp_err_t esp_ota_begin(  
    const esp_partition_t* partition,  
    size_t image_size,  
    esp_ota_handle_t* out_handle)
```

- `partition` – The partition to load with the new image. This is an input parameter.
- `image_size` – The size of the new image. If at the time of starting the OTA transaction we don't know the size of the image, supply the constant `OTA_SIZE_UNKNOWN`.

- `out_handle` – The handle used for this OTA activity. This is an output parameter.

Includes:

- `#include <esp_ota_ops.h>`

See also:

- `esp_ota_end`
- `esp_ota_get_next_update_partition`

See also:

- `esp_ota_end`

### **esp\_ota\_end**

Finish the update and validate the image.

```
esp_err_t esp_ota_end(esp_ota_handle_t handle)
```

The `handle` comes from a previous call to `esp_ota_begin()`.

Includes:

- `#include <esp_ota_ops.h>`

See also:

- `esp_ota_begin`

### **esp\_ota\_get\_boot\_partition**

Get the partition information of the current boot partition.

```
const esp_partition_t* esp_ota_get_boot_partition(void)
```

Includes:

- `#include <esp_ota_ops.h>`

### **esp\_ota\_get\_next\_update\_partition**

```
const esp_partition_t* esp_ota_get_next_update_partition(  
    const esp_partition_t *start_from)
```

Get the next update partition that can be used as the target for a new OTA load and passed into `esp_ota_begin()`.

Includes:

- `#include <esp_ota_ops.h>`

See also:

- `esp_ota_begin`

### **esp\_ota\_get\_running\_partition**

```
const esp_partition_t* esp_ota_get_running_partition(void)
```

Includes:

- `#include <esp_ota_ops.h>`

### **esp\_ota\_set\_boot\_partition**

Set the partition of the next partition to be booted.

```
esp_err_t esp_ota_set_boot_partition(const esp_partition_t* partition)
```

A subsequent call to `esp_restart()` will cause this partition's app to be booted.

Includes:

- `#include <esp_ota_ops.h>`

See also:

- `esp_restart`

### **esp\_ota\_write**

Write data into the OTA partition.

```
esp_err_t esp_ota_write(  
    esp_ota_handle_t handle,  
    const void*      data,  
    size_t           size)
```

Stream more data into the OTA partition being written to with the new application version. The `handle` comes from a previous call to `esp_ota_begin()`.

- `data` – A pointer to a chunk of data to write.
- `size` – The size of this chunk of data.

Includes:

- `#include <esp_ota_ops.h>`

## esp\_https\_ota

Perform an OTA request from a given HTTP endpoint.

```
esp_err_t esp_https_ota(const esp_http_client_config_t *config)
```

Includes:

- `#include <esp_https_ota.h>`

## GPIO Driver

The gpio functions in the ESP32 are provided through the ESP-IDF. One must include the "driver/gpio.h" header.

See also:

- GPIOs
- Analog to Digital Conversion

## gpio\_config

Configure one or more GPIO settings in a single operation.

```
esp_err_t gpio_config(gpio_config_t *pGPIOConfig)
```

The `gpio_config_t` data structure contains:

```
uint64_t pin_bit_mask
gpio_mode_t mode
gpio_pullup_t pull_up_en
gpio_pulldown_t pull_down_en
gpio_int_type_t intr_type
```

The `pin_bit_mask` defines which pins we are configuring. Constants are defined to assist us here. For example, if we are configuring GPIO16 and GPIO34 we can set the `pin_bit_mask` to `GPIO_SEL_16 | GPIO_SEL_34` which is the boolean "or" of the two constant values.

The `mode` is used to set the mode of all of the pins we are configuring. The allowable values are:

- `GPIO_MODE_INPUT`
- `GPIO_MODE_OUTPUT`
- `GPIO_MODE_OUTPUT_OD`



- GPIO\_MODE\_INPUT\_OUTPUT\_OD
- GPIO\_MODE\_INPUT\_OUTPUT

The `pull_up_en` enables an internal pull-up resistor. The allowable values are:

- GPIO\_PULLUP\_ENABLE
- GPIO\_PULLUP\_DISABLE

The `pull_down_en` enables an internal pull-down resistor. The allowable values are:

- GPIO\_PULLDOWN\_ENABLE
- GPIO\_PULLDOWN\_DISABLE

The `intr_type` configures how interrupts are handled for the pin. The allowable values are:

- GPIO\_INTR\_DISABLE
- GPIO\_INTR\_POSEDGE
- GPIO\_INTR\_NEGEDGE
- GPIO\_INTR\_ANYEDGE
- GPIO\_INTR\_LOW\_LEVEL
- GPIO\_INTR\_HIGH\_LEVEL

Here is an example:

```
gpio_config_t gpioConfig;
gpioConfig.pin_bit_mask = (1 << 16) | (1 << 17);
gpioConfig.mode = GPIO_MODE_OUTPUT;
gpioConfig.pull_up_en = GPIO_PULLUP_DISABLE;
gpioConfig.pull_down_en = GPIO_PULLDOWN_DISABLE;
gpioConfig.intr_type = GPIO_INTR_DISABLE;
gpio_config(&gpioConfig);
```

By setting the mode to `GPIO_MODE_INPUT_OUTPUT_OD`, we can read back the last value we set on the pin.

Includes:

- `#include <driver/gpio.h>`

### **gpio\_get\_level**

Retrieve the signal level on the pin.

```
int gpio_get_level(gpio_num_t gpioNum)
```

Get the signal level on the specified pin. Either 0 or 1. The direction of the pin should be set to be INPUT to retrieve a useful result.

Includes

- `#include <driver/gpio.h>`

See also:

- `gpio_set_direction`
- GPIOs

### **gpio\_install\_isr\_service**

Install the GPIO ISR service.

```
esp_err_t gpio_install_isr_service(int intr_alloc_flags)
```

Think of this as a pre-supplied handler that ESP-IDF makes available to provide per-GPIO ISR routines. Those are registered with calls to `gpio_isr_handler_add()`.

Includes:

- `#include <driver/gpio.h>`

See also:

- `gpio_uninstall_isr_service`
- `gpio_isr_handler_add`
- `gpio_isr_handler_remove`

### **gpio\_intr\_enable**

Enable interrupts on the specified pin.

```
esp_err_t gpio_intr_enable(gpio_num_t gpioNum)
```

Enabling the interrupt on the pin will cause an interrupt trigger when the type of interrupt as specified by `gpio_set_intr_type()` occurs.

Includes

- `#include <driver/gpio.h>`

See also:

- GPIO Interrupt handling
- `gpio_set_intr_type`
- `gpio_intr_disable`

## gpio\_intr\_disable

Disable interrupts on the specified pin.

```
esp_err_t gpio_intr_disable(gpio_num_t gpioNum)
```

Disabling the interrupt on the pin will prevent an interrupt trigger from being registered.

Includes

- `#include <driver/gpio.h>`

See also:

- `gpio_intr_enable`

## gpio\_isr\_handler\_add

Associate an ISR with a given pin.

```
esp_err_t gpio_isr_handler_add(  
    gpio_num_t gpio_num,  
    gpio_isr_t isr_handler,  
    void*      args)
```

The `gpio_num` is the pin to which we are associating an interrupt handler. This can be one of the `GPIO_NUM_XX` values.

The `isr_handler` is the function we wish to invoke to process the interrupt. The handler does not need to be declared in instruction RAM unless the ISR is defined with the `ESP_INTR_FLAG_IRAM`.

The signature of an interrupt handler function is:

```
void func(void *args)
```

The `args` is a pointer that will be passed to the ISR.

Includes:

- `#include <driver/gpio.h>`

See also:

- `gpio_install_isr_service`
- `gpio_isr_handler_remove`
- GPIO Interrupt handling

## gpio\_isr\_handler\_remove

Remove a previously associated ISR handler.

```
esp_err_t gpio_isr_handler_remove(gpio_num_t gpio_num)
```

The `gpio_num` identifies the pin against which any ISR handler should be removed. This can be one of the `GPIO_NUM_XX` values.

Includes:

- `#include <driver/gpio.h>`

See also:

- `gpio_isr_handler_add`
- `gpio_install_isr_service`

## gpio\_isr\_register

Register an interrupt handler.

```
esp_err_t gpio_isr_register(  
    void (*fn)(void *), void *arg,  
    int intr_alloc_flags,  
    gpio_isr_handle_t handle)
```

The `fn` is a function that will be called to handle the interrupt. The implementation of this function must reside in instruction RAM (IRAM) as it must be handled as quickly as possible and we can't afford loading it from flash. The function must be defined with the `"IRAM_ATTR"` function to force it to be in IRAM.

For example:

```
static void IRAM_ATTR myISR(void *arg) {  
    // Do something.  
}
```

If we want to perform logging within the handler, we must use:

```
ESP_EARLY_LOGx()
```

The `arg` is a parameter passed into the interrupt handler function (`fn`).

The flags are flags that control the definition of the interrupt.

- `ESP_INTR_FLAG_INTRDISABLED`
- `ESP_INTR_FLAG_IRAM`
- ???

The `handle` is a handle used to reference this ISR and is populated on return from this call.

Note that this is only *one* of the techniques for ISR processing. The other is the combination of `gpio_install_isr_service()` and `gpio_isr_handled_add()`.

Includes

- `#include <driver/gpio.h>`

See also:

- GPIO Interrupt handling

### **gpio\_set\_direction**

Set the direction of a pin.

```
esp_err_t gpio_set_direction(gpio_num_t gpioNum, gpio_mode_t mode)
```

The `mode` is used to set the mode of the pin we are configuring. The allowable values are:

- `GPIO_MODE_INPUT`
- `GPIO_MODE_OUTPUT`
- `GPIO_MODE_OUTPUT_OD`
- `GPIO_MODE_INPUT_OUTPUT_OD`
- `GPIO_MODE_INPUT_OUTPUT`

Interestingly, there is no equivalent to get the current direction.

Includes:

- `#include <driver/gpio.h>`

See also:

- GPIOs
- `gpio_get_level`
- `gpio_set_level`

### **gpio\_set\_intr\_type**

Set the interrupt type of a pin.

```
esp_err_t gpio_set_intr_type(gpio_num_t gpioNum, gpio_int_type_t intrType)
```

The `gpioNum` defines which pins is having its interrupt type changed. This can be one of the `GPIO_NUM_XX` values.

The `intr_type` configures how interrupts are handled for the pin. The allowable values are:

- `GPIO_INTR_ANYEDGE`
- `GPIO_INTR_DISABLE`
- `GPIO_INTR_NEGEDGE`
- `GPIO_INTR_POSEDGE`
- `GPIO_INTR_LOW_LEVEL`
- `GPIO_INTR_HIGH_LEVEL`

### Includes

- `#include <driver/gpio.h>`

### See also:

- GPIO Interrupt handling
- `gpio_isr_register`

### `gpio_set_level`

Set the level of a pin.

```
esp_err_t gpio_set_level(gpio_num_t gpioNum, uint32_t level)
```

Set the level of an output pin. The `level` should be either 0 or 1.

### Includes:

- `#include <driver/gpio.h>`

### See also:

- GPIOs
- `gpio_set_direction`
- `gpio_get_level`

### `gpio_set_pull_mode`

Set the pullup/pulldown mode of the pin.

```
esp_err_t gpio_set_pull_mode(gpio_num_t gpioNum, gpio_pull_mode_t pull)
```

The allowable values for pull are:

- `GPIO_PULLUP_ONLY` – Set the pin to be pulled-up. If no active signal on the pin, it will register as high.

- `GPIO_PULLDOWN_ONLY` – Set the pin to be pulled-down. If no active signal on the pin, it will register as low.
- `GPIO_PULLUP_PULLDOWN` – Set the pin to be both pulled-up and pulled-down so that if there is no actual signal on the input, it will be ½ the reference voltage.
- `GPIO_FLOATING` – No pull-up or pull-down. It is not defined what signal will be read from this pin if there is no active signal.

Includes:

- `#include <driver/gpio.h>`

See also:

- Pull up and pull down settings

### **gpio\_uninstall\_isr\_service**

```
void gpio_uninstall_isr_service()
```

Includes:

- `#include <driver/gpio.h>`

See also:

- `gpio_install_isr_service`

### **gpio\_wakeup\_enable**

Enable GPIO wake-up.

```
esp_err_t gpio_wakeup_enable(gpio_num_t gpioNum, gpio_int_type_t intrType)
```

Wake-up a sleeping device when an interrupt occurs. The allowable interrupt types are:

- `GPIO_INTR_LOW_LEVEL`
- `GPIO_INTR_HIGH_LEVEL`

Includes

- `#include <driver/gpio.h>`

See also:

- `gpio_wakeup_disable`

### **gpio\_wakeup\_disable**

Disable GPIO wake-up.

```
esp_err_t gpio_wakeup_disable(gpio_num_t gpioNum)
```

Disable waking up on a pin interrupt.

Includes

- `#include <driver/gpio.h>`

See also:

- `gpio_wakeup_enable`

## GPIO Low Level

### **gpio\_init**

Initialize GPIO.

```
void gpio_init()
```

This is a ROM exposed function. It should not be called in normal applications.

Includes

- `#include <rom/gpio.h>`

### **gpio\_input\_get**

Retrieve a bit-mask of the values of the first 32 GPIOs (0-31).

```
uint32_t gpio_input_get()
```

Includes:

- `#include <rom/gpio.h>`

### **gpio\_input\_get\_high**

Retrieve a bit-mask of the values of the last 8 GPIOs (32-39).

```
uint32_t gpio_input_get_high()
```

Includes:

- `#include <rom/gpio.h>`

### **gpio\_intr\_ack**

```
void gpio_intr_ack(uint32_t ackMask)
```



This is a ROM exposed function. It is not expected to be called in normal applications.

Includes:

- rom/gpio.h

### **gpio\_intr\_ack\_high**

```
void gpio_intr_ack_high(uint32_t ackMask)
```

This is a ROM exposed function. It is not expected to be called in normal applications.

Includes

- #include <rom/gpio.h>

### **gpio\_intr\_handler\_register**

```
void gpio_intr_handler_register(  
    gpio_intr_handler_fn_t fn,  
    void *arg)
```

This is a ROM exposed function. It is not expected to be called in normal applications.

Includes

- #include <rom/gpio.h>

### **gpio\_intr\_pending**

```
uint32_t gpio_intr_pending()
```

This is a ROM exposed function. It is not expected to be called in normal applications.

Includes

- #include <rom/gpio.h>

### **gpio\_intr\_pending\_high**

```
uint32_t gpio_intr_pending_high()
```

This is a ROM exposed function. It is not expected to be called in normal applications.

Includes

- `#include <rom/gpio.h>`

### **gpio\_matrix\_in**

Map a physical pin to its logical mapping.

```
void gpio_matrix_in(  
    uint32_t gpioNum,  
    uint32_t signalIdx,  
    bool     inv)
```

Here we can map a physical input pin to its logical mapping. This is the heart of the multiplexing function.

Two special physical gpio number are used. The value `0x30` means a constant low value while `0x38` means a constant high value.

If the `inv` flag is set then the incoming signal is logically inverted before processing.

Includes

- `#include <rom/gpio.h>`

See also:

- Pads and multiplexing

### **gpio\_matrix\_out**

Set the signal output to a given gpio.

```
void gpio_matrix_out(  
    uint32_t gpio,  
    uint32_t signalIdx,  
    bool outInv,  
    bool oenInv)
```

The `gpio` is the gpio output number between 0 and 39. The `signalIdx` is the index of the signal to be sent to that gpio. To invert the signal set `outInv` to be 1. To invert the signal output enable set `oenInv` to be 1.

Includes

- `#include <rom/gpio.h>`

See also:

- Pads and multiplexing

### **gpio\_output\_set**

Set GPIOs that need to be input, output, high or low on bulk

```
void gpio_output_set(  
    uint32_t setMask,  
    uint32_t clearMask,  
    uint32_t enableMask,  
    uint32_t disableMask)
```

Work with the first 32 GPIOs (0-31) specifying which ones are input, which ones are output, which ones should be left alone and which ones should be set high/low. This API lets us set a batch of GPIOs in one operation.

Includes

- `#include <rom/gpio.h>`

### **gpio\_output\_set\_high**

Set GPIOs that need to be input, output, high or low on bulk

```
void gpio_output_set_high(  
    uint32_t setMask,  
    uint32_t clearMask,  
    uint32_t enableMask,  
    uint32_t disableMask)
```

Work with the last 8 GPIOs (32-39) specifying which ones are input, which ones are output, which ones should be left alone and which ones should be set high/low. This API lets us set a batch of GPIOs in one operation.

Includes

- `#include <rom/gpio.h>`

### **gpio\_pad\_hold**

```
void gpio_pad_hold(uint8_t gpioNum)
```

Includes

- `#include <rom/gpio.h>`

### **gpio\_pad\_pulldown**

```
void gpio_pad_pulldown(uint8_t gpioNum)
```

#### **Includes**

- `#include <rom/gpio.h>`

### **gpio\_pad\_pullup**

```
void gpio_pad_pullup(uint8_t gpioNum)
```

#### **Includes**

- `#include <rom/gpio.h>`

### **gpio\_pad\_select\_gpio**

Specify that a given pin should be used for GPIO.

```
void gpio_pad_select_gpio(uint8_t gpioNum)
```

The `gpioNum` is the identity of the GPIO (0-39).

#### **Includes**

- `#include <rom/gpio.h>`

#### **See also:**

- [GPIOs](#)

### **gpio\_pad\_set\_drv**

```
void gpio_pad_set_drv(uint8_t gpioNum, uint8_t drv)
```

#### **Includes**

- `#include <rom/gpio.h>`

### **gpio\_pad\_unhold**

```
void gpio_pad_unhold(uint8_t gpioNum)
```

#### **Includes**

- `#include <rom/gpio.h>`

### **gpio\_pin\_wakeup\_disable**

`void gpio_pin_wakeup_disable()`

This is a ROM exposed function. It is not expected to be called in normal applications.

Includes

- `#include <rom/gpio.h>`

### **gpio\_pin\_wakeup\_enable**

`void gpio_pin_wakeup_enable(uint32_t I, GPIO_INT_TYPE intrState)`

This is a ROM exposed function. It is not expected to be called in normal applications.

Includes

- `#include <rom/gpio.h>`

## **GPIO RTC**

### **rtc\_gpio\_init**

`esp_err_t rtc_gpio_init(gpio_num_t gpio_num)`

### **rtc\_gpio\_deinit**

`esp_err_t rtc_gpio_deinit(gpio_num_t gpio_num)`

### **rtc\_gpio\_get\_level**

`uint32_t rtc_gpio_get_level(gpio_num_t gpio_num)`

### **rtc\_gpio\_set\_level**

`esp_err_t rtc_gpio_set_level(gpio_num_t gpio_num, uint32_t level)`

### **rtc\_gpio\_set\_direction**

`esp_err_t rtc_gpio_set_direction(gpio_num_t gpio_num, rtc_gpio_mode_t mode)`

`rtc_gpio_pullup_en`

`esp_err_t rtc_gpio_pullup_en(gpio_num_t gpio_num)`

`rtc_gpio_pulldown_en`

`esp_err_t rtc_gpio_pulldown_en(gpio_num_t gpio_num)`

`rtc_gpio_pullup_dis`

`esp_err_t rtc_gpio_pullup_dis(gpio_num_t gpio_num)`

## Interrupts

Normally, we think of an application running from sequential code statements one after the other and that these run to completion without performing other tasks. The reality is that there are times when we aren't prepared to wait to "poll" some peripheral to see if may or may not have data for us. Instead we want to be interrupted in the middle of whatever we are doing, do something else and then return to the activity that was previously being executed. This concept is called an interrupt. A function that is invoked as a result of an interrupt occurring is called an Interrupt Service Routine (ISR). The signature of this function is:

```
void IRAM_ATTR func(void* arg)
```

Now we distinguish between internal and external peripheral interrupts. Internal interrupts originate within the CPU core itself while external interrupts originate from a peripheral in the CPU.

There are six internal interrupts. These are:

- `ETS_INTERNAL_TIMER0_INTR_SOURCE`
- `ETS_INTERNAL_TIMER1_INTR_SOURCE`
- `ETS_INTERNAL_TIMER2_INTR_SOURCE`
- `ETS_INTERNAL_SW0_INTR_SOURCE`
- `ETS_INTERNAL_SW1_INTR_SOURCE`
- `ETS_ETS_INTERNAL_PROFILING_INTR_SOURCE`

The external interrupts are:

- `ETS_WIFI_MAC_INTR_SOURCE`
- `ETS_WIFI_MAC_NMI_SOURCE`
- `ETS_WIFI_BB_INTR_SOURCE`
- `ETS_BT_MAC_INTR_SOURCE`
- `ETS_BT_BB_INTR_SOURCE`

- ETS\_BT\_BB\_NMI\_SOURCE
- ETS\_RWBT\_INTR\_SOURCE
- ETS\_RWBLE\_INTR\_SOURCE
- ETS\_RWBT\_NMI\_SOURCE
- ETS\_RWBLE\_NMI\_SOURCE
- ETS\_SLC0\_INTR\_SOURCE
- ETS\_SLC1\_INTR\_SOURCE
- ETS\_UHCI0\_INTR\_SOURCE
- ETS\_UHCI1\_INTR\_SOURCE
- ETS\_TG0\_T0\_LEVEL\_INTR\_SOURCE
- ETS\_TG0\_T1\_LEVEL\_INTR\_SOURCE
- ETS\_TG0\_WDT\_LEVEL\_INTR\_SOURCE
- ETS\_TG0\_LACT\_LEVEL\_INTR\_SOURCE
- ETS\_TG1\_T0\_LEVEL\_INTR\_SOURCE
- ETS\_TG1\_T1\_LEVEL\_INTR\_SOURCE
- ETS\_TG1\_WDT\_LEVEL\_INTR\_SOURCE
- ETS\_TG1\_LACT\_LEVEL\_INTR\_SOURCE
- ETS\_GPIO\_INTR\_SOURCE
- ETS\_GPIO\_NMI\_SOURCE
- ETS\_FROM\_CPU\_INTR0\_SOURCE
- ETS\_FROM\_CPU\_INTR1\_SOURCE
- ETS\_FROM\_CPU\_INTR2\_SOURCE
- ETS\_FROM\_CPU\_INTR3\_SOURCE
- ETS\_SPI0\_INTR\_SOURCE
- ETS\_SPI1\_INTR\_SOURCE
- ETS\_SPI2\_INTR\_SOURCE
- ETS\_SPI3\_INTR\_SOURCE
- ETS\_I2S0\_INTR\_SOURCE – Source of interrupts for I2S0.

- ETS\_I2S1\_INTR\_SOURCE – Source of interrupts for I2S1.
- ETS\_UART0\_INTR\_SOURCE
- ETS\_UART1\_INTR\_SOURCE
- ETS\_UART2\_INTR\_SOURCE
- ETS\_SDIO\_HOST\_INTR\_SOURCE
- ETS\_ETH\_MAC\_INTR\_SOURCE
- ETS\_PWM0\_INTR\_SOURCE
- ETS\_PWM1\_INTR\_SOURCE
- ETS\_PWM2\_INTR\_SOURCE
- ETS\_PWM3\_INTR\_SOURCE
- ETS\_LEDC\_INTR\_SOURCE
- ETS\_EFUSE\_INTR\_SOURCE
- ETS\_CAN\_INTR\_SOURCE
- ETS\_RTC\_CORE\_INTR\_SOURCE
- ETS\_RMT\_INTR\_SOURCE
- ETS\_PCNT\_INTR\_SOURCE
- ETS\_I2C\_EXT0\_INTR\_SOURCE
- ETS\_I2C\_EXT1\_INTR\_SOURCE
- ETS\_RSA\_INTR\_SOURCE
- ETS\_SPI1\_DMA\_INTR\_SOURCE
- ETS\_SPI2\_DMA\_INTR\_SOURCE
- ETS\_SPI3\_DMA\_INTR\_SOURCE
- ETS\_WDT\_INTR\_SOURCE
- ETS\_TIMER1\_INTR\_SOURCE
- ETS\_TIMER2\_INTR\_SOURCE
- ETS\_TG0\_T0\_EDGE\_INTR\_SOURCE
- ETS\_TG0\_T1\_EDGE\_INTR\_SOURCE
- ETS\_TG0\_WDT\_EDGE\_INTR\_SOURCE
- ETS\_TG0\_LACT\_EDGE\_INTR\_SOURCE



- ETS\_TG1\_T0\_EDGE\_INTR\_SOURCE
- ETS\_TG1\_T1\_EDGE\_INTR\_SOURCE
- ETS\_TG1\_WDT\_EDGE\_INTR\_SOURCE
- ETS\_TG1\_LACT\_EDGE\_INTR\_SOURCE
- ETS\_MMU\_IA\_INTR\_SOURCE
- ETS\_MPU\_IA\_INTR\_SOURCE
- ETS\_CACHE\_IA\_INTR\_SOURCE

The ESP32 provides 32 interrupts (per CPU).

<b>Intrerrupt Number</b>	<b>Category</b>	<b>Type</b>	<b>Priority</b>
0	Peripheral	Level-Triggered	1
1	Peripheral	Level-Triggered	1
2	Peripheral	Level-Triggered	1
3	Peripheral	Level-Triggered	1
4	Peripheral	Level-Triggered	1
5	Peripheral	Level-Triggered	1
6	Internal	Timer.0	1
7	Internal	Software	1
8	Peripheral	Level-Triggered	1
9	Peripheral	Level-Triggered	1
10	Peripheral	Edge-Triggered	1
11	Internal	Profiling	3
12	Peripheral	Level-Triggered	1
13	Peripheral	Level-Triggered	1
14	Peripheral	NMI	NMI
15	Internal	Timer.1	3
16	Internal	Timer.2	5
17	Peripheral	Level-Triggered	1
18	Peripheral	Level-Triggered	1
19	Peripheral	Level-Triggered	2
20	Peripheral	Level-Triggered	2
21	Peripheral	Level-Triggered	2
22	Peripheral	Edge-Triggered	3
23	Peripheral	Level-Triggered	3
24	Peripheral	Level-Triggered	4
25	Peripheral	Level-Triggered	4
26	Peripheral	Level-Triggered	5
27	Peripheral	Level-Triggered	3
28	Peripheral	Edge-Triggered	4
29	Internal	Software	3
30	Peripheral	Edge-Triggered	4
31	Peripheral	Level-Triggered	5

See also:

- [ESP-IDF Docs – Interrupt allocation](#)
- [ESP-IDF Docs – High-Level Interrupts](#)

## esp\_intr\_alloc

```
esp_err_t esp_intr_alloc(
    int          source,
    int          flags,
    intr_handler_t handler,
    void*        arg,
    intr_handle_t* ret_handle)
```

- `source` – The source of the interrupt.
- `flags` – Flags for registering the interrupt. Includes:
  - `ESP_INTR_FLAG_INTRDISABLED` – Return with the interrupt disabled. Can be enabled with a subsequent call to `esp_intr_enable()`.
  - `ESP_INTR_FLAG_IRAM` – Can be called if cache disabled.
  - `ESP_INTR_FLAG_LEVEL1`
  - `ESP_INTR_FLAG_LEVEL2`
  - `ESP_INTR_FLAG_LEVEL3`
  - `ESP_INTR_FLAG_LEVEL4`
  - `ESP_INTR_FLAG_LEVEL5`
  - `ESP_INTR_FLAG_LEVEL6`
  - `ESP_INTR_FLAG_NMI`
  - `ESP_INTR_FLAG_SHARED` – Can be shared between ISRs.
  - `ESP_INTR_FLAG_EDGE` – Edge triggered interrupt.
  - `ESP_INTR_FLAG_LOWMED` – Same as `ESP_INTR_FLAG_LEVEL1` | `ESP_INTR_FLAG_LEVEL2` | `ESP_INTR_FLAG_LEVEL3`.
  - `ESP_INTR_FLAG_HIGH` – Same as `ESP_INTR_FLAG_LEVEL4` | `ESP_INTR_FLAG_LEVEL5` | `ESP_INTR_FLAG_LEVEL6` | `ESP_INTR_FLAG_NMI`.
  - `ESP_INTR_FLAG_LEVELMASK` – Same as `ESP_INTR_FLAG_LEVEL1` | `ESP_INTR_FLAG_LEVEL2` | `ESP_INTR_FLAG_LEVEL3` | `ESP_INTR_FLAG_LEVEL4` | `ESP_INTR_FLAG_LEVEL5` | `ESP_INTR_FLAG_LEVEL6` | `ESP_INTR_FLAG_NMI`
- `handler`
- `arg` – Optional argument passed into the interrupt handler.

- `ret_handle` – Handle to be used to query or free the interrupt. May be NULL if no handle is required.

Includes:

- `#include <esp_intr_alloc.h>`

### **esp\_intr\_alloc\_intrstatus**

```
esp_err_t esp_intr_alloc_intrstatus(
    int          source,
    int          flags,
    uint32_t     intrstatusreg,
    uint32_t     intrstatusmask,
    intr_handler_t handler,
    void*        arg,
    intr_handle_t* ret_handle)
```

- `source` – The source of the interrupt.
- `flags`
- `intrstatusreg`
- `intrstatusmask`
- `handler`
- `arg` – Optional argument passed into the interrupt handler.
- `ret_handle` – Handle to be used to query or free the interrupt. May be NULL if no handle is required.

Includes:

- `#include <esp_intr_alloc.h>`

### **esp\_intr\_disable**

Disable the interrupt.

```
esp_err_t esp_intr_disable(intr_handle_t handle)
```

An interrupt handler can be disabled by calling this function or by creating with the flag `ESP_INTR_FLAG_INTRDISABLED`. It can be subsequently re-enabled by calling `esp_intr_enable()`.

Includes:

- `#include <esp_intr_alloc.h>`

See also:

- `esp_intr_alloc`
- `esp_intr_alloc_intrstatus`
- `esp_intr_enable`

### **esp\_intr\_enable**

Enable the interrupt processing.

```
esp_err_t esp_intr_enable(intr_handle_t handle)
```

Interrupt processing can be disabled by creating the interrupt with the flag including `ESP_INTR_FLAG_INTRDISABLED` or by called `esp_intr_disable()`.

Includes:

- `#include <esp_intr_alloc.h>`

See also:

- `esp_intr_alloc`
- `esp_intr_alloc_intrstatus`
- `esp_intr_disable`

### **esp\_intr\_free**

Release the resources for an interrupt.

```
esp_err_t esp_intr_free(intr_handle_t handle)
```

Includes:

- `#include <esp_intr_alloc.h>`

See also:

- `esp_intr_alloc`
- `esp_intr_alloc_intrstatus`

### **esp\_intr\_get\_cpu**

```
int esp_intr_get_cpu(intr_handle_t handle)
```

Includes:

- `#include <esp_intr_alloc.h>`

See also:

- `esp_intr_alloc`
- `esp_intr_alloc_intrstatus`

### **esp\_intr\_get\_intno**

```
int esp_intr_get_intno(intr_handle_t handle)
```

Includes:

- `#include <esp_intr_alloc.h>`

See also:

- `esp_intr_alloc`
- `esp_intr_alloc_intrstatus`

### **esp\_intr\_mark\_shared**

Mark the interrupt as shared.

```
esp_err_t esp_intr_mark_shared(int intno, int cpu, bool is_in_iram)
```

- `intno` – The number of the interrupt. 0-31.
- `cpu` – The CPU on which the interrupt is marked as shared (0-1).
- `is_in_iram` – Is the handler in IRAM?

Includes:

- `#include <esp_intr_alloc.h>`

### **esp\_intr\_noniram\_disable**

```
void esp_intr_noniram_disable()
```

Includes:

- `#include <esp_intr_alloc.h>`

### **esp\_intr\_noniram\_enable**

```
void esp_intr_noniram_enable()
```

Includes:

- `#include <esp_intr_alloc.h>`

### **esp\_intr\_reserve**

Mark the interrupt as reserved.

```
esp_err_t esp_intr_reserve(int intno, int cpu)
```

Includes:

- `#include <esp_intr_alloc.h>`

### `esp_intr_set_in_iram`

```
esp_err_t esp_intr_set_in_iram(intr_handle_t handle, bool is_in_iram)
```

Includes:

- `#include <esp_intr_alloc.h>`

## Analog to Digital Conversion

When WiFi or BT are enabled, ADC2 is **not** available for use.

See also:

- [Analog to digital conversion](#)
- [ESP32 Docs – Analog to Digital Converter](#)

### `adc1_config_channel_atten`

Change the attenuation value of the channel.

```
esp_err_t adc1_config_channel_atten(  
    adc1_channel_t channel,  
    adc_atten_t    atten)
```

By default, the input voltage can be between 0V and 1V, however using the attenuation values, we can scale the voltage to be between 0-1.34V, 0-2V and 0-3.6V.

The `channel` can be between `ADC1_CHANNEL_0` and `ADC1_CHANNEL_7`.

The `atten` can be one of:

- `ADC_ATTEN_0db` – 0-1
- `ADC_ATTEN_2_5db` – 0-1.34
- `ADC_ATTEN_6db` – 0-2
- `ADC_ATTEN_11db` – 0-3.6

Includes:

- `#include <driver/adc.h>`

### **adc1\_config\_width**

Set the ADC resolution.

```
esp_err_t adc1_config_width(adc_bits_width_t width_bit)
```

The `width_bit` value may be one of:

- `ADC_WIDTH_9Bit`
- `ADC_WIDTH_10Bit`
- `ADC_WIDTH_11Bit`
- `ADC_WIDTH_12Bit`

Includes:

- `#include <driver/adc.h>`

### **adc1\_get\_voltage**

Read the digital value of the analog input.

```
int adc1_get_voltage(adc1_channel_t channel)
```

If the value `<0` then an error was encountered otherwise the value is the digital value of the voltage on the channel. The `channel` can be between `ADC1_CHANNEL_0` and `ADC1_CHANNEL_7`.

Includes:

- `#include <driver/adc.h>`

### **hall\_sensor\_read**

```
int hall_sensor_read()
```

## **Digital to Analog Conversion**

See also:

- [ESP32 docs – Digital to Analog Converter](#)

### **dac\_i2s\_disable**

Disable output from I2S.

```
esp_err_t dac_i2s_disable()
```



Includes:

- `#include <driver/dac.h>`

See also:

- [ESP-IDF docs – Digital to analog converter](#)
- `dac_i2s_enable`

### **dac\_i2s\_enable**

Enable output from I2S.

```
esp_err_t dac_i2s_enable()
```

See also:

- [ESP-IDF docs – Digital to analog converter](#)
- `dac_i2s_disable`

Includes:

- `#include <driver/dac.h>`

See also:

- [ESP-IDF docs – Digital to analog converter](#)

### **dac\_output\_disable**

Disable the DAC channel output.

```
esp_err_t dac_output_disable(dac_channel_t channel)
```

- `channel`
  - `DAC_CHANNEL_1` – GPIO 25
  - `DAC_CHANNEL_2` – GPIO 26

Includes:

- `#include <driver/dac.h>`

See also:

- [ESP-IDF docs – Digital to analog converter](#)

### **dac\_output\_enable**

Enable the DAC channel output.

```
esp_err_t dac_output_enable(dac_channel_t channel)
```

- **channel**
  - DAC\_CHANNEL\_1 – GPIO 25
  - DAC\_CHANNEL\_2 – GPIO 26

Includes:

- `#include <driver/dac.h>`

See also:

- [ESP-IDF docs – Digital to analog converter](#)

### **dac\_output\_voltage**

Set the output value on the DAC channel output.

```
esp_err_t dac_output_voltage(dac_channel_t channel, uint8_t dac_value)
```

- **channel**
  - DAC\_CHANNEL\_1 – GPIO 25
  - DAC\_CHANNEL\_2 – GPIO 26

Includes:

- `#include <driver/dac.h>`

See also:

- [ESP-IDF docs – Digital to analog converter](#)

### **dac\_pad\_get\_io\_num**

Get the GPIO number of a specific DAC channel.

```
esp_err_t dac_pad_get_io_num(dac_channel_t channel, gpio_num_t* gpio_num)
```

Retrieve the pin used for the given channel.

- **channel**
  - DAC\_CHANNEL\_1 – GPIO 25
  - DAC\_CHANNEL\_2 – GPIO 26

Includes:

- `#include <driver/dac.h>`

See also:

- [ESP-IDF docs – Digital to analog converter](#)

## UART driver API

The ESP-IDF provides a driver for the UART interfaces.

See also:

- [Working with UART/serial](#)

### uart\_clear\_intr\_status

```
esp_err_t uart_clear_intr_status(  
    uart_port_t uart_num,  
    uint32_t    clr_mask)
```

The `uart_no` is the identity of the UART being changed. It can be one of `UART_NUM_0`, `UART_NUM_1` or `UART_NUM_2`.

The `clr_mask` represents the bits to be cleared.

Includes:

- `#include <driver/uart.h>`

See also:

- [Working with UART/serial](#)

### uart\_disable\_intr\_mask

```
esp_err_t uart_disable_intr_mask(  
    uart_port_t uart_num,  
    uint32_t    disable_mask)
```

The `uart_no` is the identity of the UART being changed. It can be one of `UART_NUM_0`, `UART_NUM_1` or `UART_NUM_2`.

The `disable_mask` represents the bits to be disabled.

Includes:

- `#include <driver/uart.h>`

See also:

- [Working with UART/serial](#)

### uart\_driver\_delete

Un-install the UART driver.

```
esp_err_t uart_driver_delete(uart_port_t uart_num)
```

The `uart_no` is the identity of the UART being changed. It can be one of `UART_NUM_0`, `UART_NUM_1` or `UART_NUM_2`.

Includes:

- `#include <driver/uart.h>`

See also:

- Working with UART/serial
- `uart_driver_install`

## uart\_driver\_install

Install the driver for the UART.

```
esp_err_t uart_driver_install(  
    uart_port_t uart_num,  
    int          rx_buffer_size,  
    int          tx_buffer_size,  
    int          queue_size,  
    void*        uart_queue,  
    int          intr_alloc_flags)
```

The `uart_no` is the identity of the UART being changed. It can be one of `UART_NUM_0`, `UART_NUM_1` or `UART_NUM_2`.

The `rx_buffer_size` is the size of the receiving ring buffer. This should be greater than the constant `UART_FIFO_LEN`.

The `tx_buffer_size` is the size of the transmitting ring buffer. If 0, then UART output will block until the data is sent.

The `queue_size` is the size of the event queue.

The `uart_queue`, if set to `NULL`, means no event queue. If we wish, we can specify the address of an instance of a FreeRTOS `QueueHandle_t` variable. If we specify that, then events related to the UART will be posted to the queue. We can then use FreeRTOS functions such as `xQueueReceive()` to read events. An event is a `uart_event_type_t` value that can be one of:

- `UART_DATA` – Data is available.
- `UART_BREAK` –
- `UART_BUFFER_FULL` –
- `UART_FIFO_OV` – A queue overflow was detected.
- `UART_FRAME_ERR` –

- `UART_PARITY_ERR` – A data parity error was detected.
- `UART_DATA_BREAK` –

The `intr_alloc_flags` are one or more flags or'd together. The value of 0 is a good default.

Includes:

- `#include <driver/uart.h>`

See also:

- Working with UART/serial
- `uart_driver_delete`

### `uart_disable_intr_mask`

```
esp_err_t uart_disable_intr_mask(
    uart_port_t uart_num,
    uint32_t disable_mask)
```

The `uart_no` is the identity of the UART being changed. It can be one of `UART_NUM_0`, `UART_NUM_1` or `UART_NUM_2`.

Includes:

- `#include <driver/uart.h>`

See also:

- Working with UART/serial

### `uart_disable_pattern_det_intr`

```
esp_err_t uart_disable_pattern_det_intr(uart_port_t uart_num)
```

Includes:

- `#include <driver/uart.h>`

See also:

- Working with UART/serial

### `uart_disable_rx_intr`

```
esp_err_t uart_disable_rx_intr(uart_port_t uart_num)
```

The `uart_no` is the identity of the UART being changed. It can be one of `UART_NUM_0`, `UART_NUM_1` or `UART_NUM_2`.

Includes:

- `#include <driver/uart.h>`

See also:

- Working with UART/serial

### **uart\_disable\_tx\_intr**

```
esp_err_t uart_disable_tx_intr(uart_port_t uart_num)
```

The `uart_no` is the identity of the UART being changed. It can be one of `UART_NUM_0`, `UART_NUM_1` OR `UART_NUM_2`.

Includes:

- `#include <driver/uart.h>`

See also:

- Working with UART/serial

### **uart\_enable\_intr\_mask**

Enable interrupts for the UART.

```
esp_err_t uart_enable_intr_mask(  
    uart_port_t uart_num,  
    uint32_t enable_mask)
```

The `uart_no` is the identity of the UART being changed. It can be one of `UART_NUM_0`, `UART_NUM_1` OR `UART_NUM_2`.

The enable mask are the bit fields set for the ESP32 register called `UART_INT_ENA_REG`.

Includes:

- `#include <driver/uart.h>`

See also:

- Working with UART/serial

### **uart\_enable\_pattern\_det\_intr**

```
esp_err_t uart_enable_pattern_det_intr(  
    uart_port_t uart_num,  
    char pattern_chr,  
    uint8_t chr_num,  
    int chr_tout,  
    int post_idle,  
    int pre_idle);
```

Includes:

- `#include <driver/uart.h>`

See also:

- [Working with UART/serial](#)

### **uart\_enable\_rx\_intr**

```
esp_err_t uart_enable_rx_intr(uart_port_t uart_num)
```

The `uart_no` is the identity of the UART being changed. It can be one of `UART_NUM_0`, `UART_NUM_1` OR `UART_NUM_2`.

Includes:

- `#include <driver/uart.h>`

See also:

- [Working with UART/serial](#)

### **uart\_enable\_tx\_intr**

```
esp_err_t uart_enable_tx_intr(  
    uart_port_t uart_num,  
    int         enable,  
    int         thresh)
```

The `uart_no` is the identity of the UART being changed. It can be one of `UART_NUM_0`, `UART_NUM_1` OR `UART_NUM_2`.

Includes:

- `#include <driver/uart.h>`

See also:

- [Working with UART/serial](#)

### **uart\_flush**

```
esp_err_t uart_flush(uart_port_t uart_num)
```

The `uart_no` is the identity of the UART being changed. It can be one of `UART_NUM_0`, `UART_NUM_1` OR `UART_NUM_2`.

Includes:

- `#include <driver/uart.h>`

See also:

- Working with UART/serial

### uart\_flush\_input

```
esp_err_t uart_flush_input(uart_port_t uart_num)
```

### uart\_get\_baudrate

Get the current baud rate.

```
esp_err_t uart_get_baudrate(  
    uart_port_t uart_num,  
    uint32_t* baudrate)
```

The `uart_no` is the identity of the UART being changed. It can be one of `UART_NUM_0`, `UART_NUM_1` or `UART_NUM_2`.

The `baud_rate` is the current transmission rate in bits per second.

Includes:

- `#include <driver/uart.h>`

See also:

- Working with UART/serial
- `uart_set_baudrate`

### uart\_get\_buffered\_data\_len

```
esp_err_t uart_get_buffered_data_len(  
    uart_port_t uart_num,  
    size_t* size)
```

Get the size of data buffered in the RX ring buffer waiting to be read.

Includes:

- `#include <driver/uart.h>`

See also:

- Working with UART/serial

### uart\_get\_collision\_flag

```
esp_err_t uart_get_collision_flag(uart_port_t uart_num, bool *collision_flag)
```

### uart\_get\_hw\_flow\_ctrl

```
esp_err_t uart_get_hw_flow_ctrl(  
    uart_port_t uart_num,  
    uart_hw_flowcontrol_t* flow_ctrl)
```



The `uart_no` is the identity of the UART being changed. It can be one of `UART_NUM_0`, `UART_NUM_1` or `UART_NUM_2`.

The `flow_ctrl` is one of `UART_HW_FLOWCTRL_DISABLE`, `UART_HW_FLOWCTRL_RTS`, `UART_HW_FLOWCTRL_CTS`, `UART_HW_FLOWCTRL_CTS_RTS`.

Includes:

- `#include <driver/uart.h>`

See also:

- Working with UART/serial
- `uart_set_hw_flow_ctrl`

### `uart_get_parity`

Get the current parity setting.

```
esp_err_t uart_get_parity(  
    uart_port_t    uart_num,  
    uart_parity_t* parity_mode)
```

The `uart_no` is the identity of the UART being changed. It can be one of `UART_NUM_0`, `UART_NUM_1` or `UART_NUM_2`.

The `parity_mode` can be one of `UART_PARITY_DISABLE`, `UART_PARITY_EVEN`, `UART_PARITY_ODD`.

Includes:

- `#include <driver/uart.h>`

See also:

- Working with UART/serial
- `uart_set_parity`

### `uart_get_stop_bits`

Retrieve the number of bits used for the stop bit.

```
esp_err_t uart_get_stop_bits(  
    uart_port_t    uart_num,  
    uart_stop_bits_t* stop_bits)
```

The `uart_no` is the identity of the UART being queried. It can be one of `UART_NUM_0`, `UART_NUM_1` or `UART_NUM_2`.

The `stop_bits` is the number of stop bits in effect. It will be one of `UART_STOP_BITS_1`, `UART_STOP_BITS_1_5` or `UART_STOP_BITS_2`.

Includes:

- `#include <driver/uart.h>`

See also:

- Working with UART/serial
- `uart_set_stop_bits`

### **uart\_get\_word\_length**

Get the current word length of a transmission.

```
esp_err_t uart_get_word_length(  
    uart_port_t      uart_num,  
    uart_word_length_t* data_bit)
```

The `uart_no` is the identity of the UART being changed. It can be one of `UART_NUM_0`, `UART_NUM_1` or `UART_NUM_2`.

The `data_bit` is the word length being used for a transmission. It can be one of `UART_DATA_5_BITS`, `UART_DATA_6_BITS`, `UART_DATA_7_BITS` or `UART_DATA_8_BITS`.

Includes:

- `#include <driver/uart.h>`

See also:

- Working with UART/serial
- `uart_set_word_length`

### **uart\_intr\_config**

```
esp_err_t uart_intr_config(  
    uart_port_t      uart_num,  
    const uart_intr_config_t* intr_conf)
```

The `uart_no` is the identity of the UART being changed. It can be one of `UART_NUM_0`, `UART_NUM_1` or `UART_NUM_2`.

The `intr_conf` is a structure containing:

- `intr_enable_mask`
  - `UART_RXFIFO_FULL_INT_ENA_M`
  - `UART_TXFIFO_EMPTY_INT_ENA_M`
  - `UART_PARITY_ERR_INT_ENA_M`
  - `UART_FRM_ERR_INT_ENA_M`
  - `UART_RXFIFO_OVF_INT_ENA_M`

- UART\_DSR\_CHG\_INT\_ENA\_M
- UART\_CTS\_CHG\_INT\_ENA\_M
- UART\_BRK\_DET\_INT\_ENA\_M
- UART\_RXFIFO\_TOUT\_INT\_ENA\_M
- UART\_SW\_XON\_INT\_ENA\_M
- UART\_SW\_XOFF\_INT\_ENA\_M
- UART\_GLITCH\_DET\_INT\_ENA\_M
- UART\_TX\_BRK\_DONE\_INT\_ENA\_M
- UART\_TX\_BRK\_IDLE\_DONE\_INT\_ENA\_M
- UART\_TX\_DONE\_INT\_ENA\_M
- UART\_RS485\_PARITY\_ERR\_INT\_ENA\_M
- UART\_RS485\_FRM\_ERR\_INT\_ENA\_M
- UART\_RS485\_CLASH\_INT\_ENA\_M
- UART\_AT\_CMD\_CHAR\_DET\_INT\_ENA\_M
- rxfifo\_full\_thresh
- rx\_timeout\_thresh
- txfifo\_empty\_intr\_thresh

Includes:

- `#include <driver/uart.h>`

See also:

- Working with UART/serial

### **uart\_isr\_free**

```
esp_err_t uart_isr_free(uart_port_t uart_num)
```

Includes:

- `#include <driver/uart.h>`

See also:

- Working with UART/serial

## uart\_isr\_register

```
esp_err_t uart_isr_register(  
    uart_port_t      uart_num,  
    void (*fn)(void*),  
    void*            arg,  
    int              intr_alloc_flags,  
    uart_isr_handle_t* handle)
```

The `uart_no` is the identity of the UART being changed. It can be one of `UART_NUM_0`, `UART_NUM_1` or `UART_NUM_2`.

Includes:

- `#include <driver/uart.h>`

See also:

- Working with UART/serial

## uart\_param\_config

Configure all the parameters for a UART.

```
esp_err_t uart_param_config(  
    uart_port_t      uart_num,  
    const uart_config_t* uart_config)
```

The `uart_no` is the identity of the UART being changed. It can be one of `UART_NUM_0`, `UART_NUM_1` or `UART_NUM_2`.

Calling this function is a convenience for setting the properties of a UART without us having to set the properties one by one with a stream of other calls. Here we populate a structure and set all the properties in one shot.

```
uart_config_t myUartConfig;  
myUartConfig.baud_rate      = 115200;  
myUartConfig.data_bits     = UART_DATA_8_BITS;  
myUartConfig.parity        = UART_PARITY_DISABLE;  
myUartConfig.stop_bits     = UART_STOP_BITS_1;  
myUartConfig.flow_ctrl     = UART_HW_FLOWCTRL_DISABLE;  
myUartConfig.rx_flow_ctrl_thresh = 120;
```

Typically we would call this before installing the driver.

Includes:

- `#include <driver/uart.h>`

See also:

- Working with UART/serial
- `uart_set_baudrate`
- `uart_set_word_length`
- `uart_set_parity`
- `uart_set_stop_bits`

- `uart_set_hw_flow_ctrl`

### **uart\_pattern\_get\_pos**

```
int uart_pattern_get_pos(uart_port_t uart_num)
```

### **uart\_pattern\_pop\_pos**

```
int uart_pattern_pop_pos(uart_port_t uart_num)
```

### **uart\_pattern\_queue\_reset**

```
esp_err_t uart_pattern_queue_reset(uart_port_t uart_num, int queue_length)
```

### **uart\_read\_bytes**

Read data from the UART.

```
int uart_read_bytes(
    uart_port_t uart_num,
    uint8_t* buf,
    uint32_t length,
    TickType_t ticks_to_wait)
```

The `uart_no` is the identity of the UART being changed. It can be one of `UART_NUM_0`, `UART_NUM_1` or `UART_NUM_2`.

Here we read data from the UART. The maximum number of bytes we will read is supplied by `length` and `buf` must point to a memory buffer of at least that capacity. Understand that we won't return until that number of bytes have been read or we time out. We might want to limit the input to 1 byte to read each byte as it arrives. The return from the function will be the number of bytes that were actually read. We can also specify the number of FreeRTOS ticks to wait should no data be immediately available. The value `portMAX_DELAY` will wait indefinitely.

Includes:

- `#include <driver/uart.h>`

See also:

- Working with UART/serial
- `uart_write_bytes`

### **uart\_set\_baudrate**

Set the current baud rate.

```
esp_err_t uart_set_baudrate(
    uart_port_t uart_no,
    uint32_t baud_rate)
```

The `uart_no` is the identity of the UART being changed. It can be one of `UART_NUM_0`, `UART_NUM_1` or `UART_NUM_2`.

The `baud_rate` is the desired transmission rate in bits per second.

Includes:

- `#include <driver/uart.h>`

See also:

- Working with UART/serial
- `uart_get_baudrate`

### **uart\_set\_dtr**

```
esp_err_t uart_set_dtr(  
    uart_port_t uart_num,  
    int level)
```

The `uart_no` is the identity of the UART being changed. It can be one of `UART_NUM_0`, `UART_NUM_1` or `UART_NUM_2`.

Includes:

- `#include <drivers/uart.h>`

See also:

- Working with UART/serial

### **uart\_set\_hw\_flow\_ctrl**

```
esp_err_t uart_set_hw_flow_ctrl(  
    uart_port_t          uart_no,  
    uart_hw_flowcontrol_t flow_ctrl,  
    uint8_t              rx_thresh)
```

The `uart_no` is the identity of the UART being changed. It can be one of `UART_NUM_0`, `UART_NUM_1` or `UART_NUM_2`.

The `flow_ctrl` is one of `UART_HW_FLOWCTRL_DISABLE`, `UART_HW_FLOWCTRL_RTS`, `UART_HW_FLOWCTRL_CTS`, `UART_HW_FLOWCTRL_CTS_RTS`.

If the `flow_ctrl` is `UART_HW_FLOWCTRL_RTS` then `rx_thresh` becomes applicable. It is recommended to set it to 0 if not being used.

Includes:

- `#include <driver/uart.h>`

See also:

- Working with UART/serial

- `uart_get_hw_flow_ctrl`

### **uart\_set\_line\_inverse**

```
esp_err_t uart_set_line_inverse(  
    uart_port_t uart_no,  
    uint32_t inverse_mask)
```

The `uart_no` is the identity of the UART being changed. It can be one of `UART_NUM_0`, `UART_NUM_1` or `UART_NUM_2`.

Includes:

- `#include <driver/uart.h>`

See also:

- Working with UART/serial

### **uart\_set\_mode**

```
esp_err_t uart_set_mode(uart_port_t uart_num, uart_mode_t mode)
```

Mode is one of:

- `UART_MODE_UART`
- `UART_MODE_RS485_HALF_DUPLEX`
- `UART_MODE_IRDA`
- `UART_MODE_RS485_COLLISION_DETECT`
- `UART_MODE_RS485_APP_CTRL`

### **uart\_set\_parity**

Set the parity check values.

```
esp_err_t uart_set_parity(  
    uart_port_t uart_no,  
    uart_parity_t parity_mode)
```

The `uart_no` is the identity of the UART being changed. It can be one of `UART_NUM_0`, `UART_NUM_1` or `UART_NUM_2`.

The `parity_mode` can be one of `UART_PARITY_DISABLE`, `UART_PARITY_EVEN`, `UART_PARITY_ODD`.

Includes:

- `#include <driver/uart.h>`

See also:

- Working with UART/serial
- `uart_get_parity`

## `uart_set_pin`

Set the pins used by this UART.

```
esp_err_t uart_set_pin(  
    uart_port_t uart_num,  
    int         tx_io_num,  
    int         rx_io_num,  
    int         rts_io_num,  
    int         cts_io_num)
```

The `uart_no` is the identity of the UART being changed. It can be one of `UART_NUM_0`, `UART_NUM_1` or `UART_NUM_2`.

The `tx_io_num` is the pin number used for TX for this uart.

The `rx_io_num` is the pin number used for RX for this uart.

The `rts_io_num` is the pin number used for RTS for this uart.

The `cts_io_num` is the pin number used for CTS for this uart.

We can specify the value `UART_PIN_NO_CHANGE` as a value and what ever the UART thinks it is currently using will continue to be used.

There is no corresponding API to query the currently set pins.

Includes:

- `#include <driver/uart.h>`

See also:

- Working with UART/serial

## `uart_set_rts`

```
esp_err_t uart_set_rts(  
    uart_port_t uart_num,  
    int         level)
```

The `uart_no` is the identity of the UART being changed. It can be one of `UART_NUM_0`, `UART_NUM_1` or `UART_NUM_2`.

Includes:

- `#include <driver/uart.h>`



See also:

- Working with UART/serial

### **uart\_set\_rx\_timeout**

```
esp_err_t uart_set_rx_timeout(uart_port_t uart_num, const uint8_t tout_thresh)
```

### **uart\_set\_stop\_bits**

Set the number of data bits in the uart.

```
esp_err_t uart_set_stop_bits(  
    uart_port_t      uart_no,  
    uart_stop_bits_t bit_num)
```

The `uart_no` is the identity of the UART being changed. It can be one of `UART_NUM_0`, `UART_NUM_1` or `UART_NUM_2`.

The `bit_num` is the number of stop bits in effect. It can be one of `UART_STOP_BITS_1`, `UART_STOP_BITS_1_5` or `UART_STOP_BITS_2`.

Includes:

- `#include <driver/uart.h>`

See also:

- Working with UART/serial
- `uart_get_stop_bits`

### **uart\_set\_sw\_flow\_ctrl**

```
esp_err_t uart_set_sw_flow_ctrl(  
    uart_port_t uart_num,  
    bool enable,  
    uint8_t rx_thresh_xon,  
    uint8_t rx_thresh_xoff)
```

### **uart\_set\_tx\_idle\_num**

```
esp_err_t uart_set_tx_idle_num(  
    uart_port_t uart_num,  
    uint16_t idle_num)
```

### **uart\_set\_word\_length**

Set the number of bits in a transmission unit.

```
esp_err_t uart_set_word_length(  
    uart_port_t      uart_num,  
    uart_word_length_t data_bit)
```

The `uart_no` is the identity of the UART being changed. It can be one of `UART_NUM_0`, `UART_NUM_1` or `UART_NUM_2`.

The `data_bit` is the word length of a transmission. It can be one of `UART_DATA_5_BITS`, `UART_DATA_6_BITS`, `UART_DATA_7_BITS` or `UART_DATA_8_BITS`.

Includes:

- `#include <driver/uart.h>`

See also:

- Working with UART/serial
- `uart_get_word_length`

### `uart_tx_chars`

Write data directly to the TX FIFO.

```
int uart_tx_chars(  
    uart_port_t uart_no,  
    const char* buffer,  
    uint32_t len)
```

The `uart_no` is the identity of the UART being transmitted over. It can be one of `UART_NUM_0`, `UART_NUM_1` or `UART_NUM_2`.

The `buffer` is a pointer to data to be transmitted. The `len` is the number of bytes to transmit. Data will be written directly into the TX FIFO rather than copying it into a ring buffer. The function may **not** copy all the data from the supplied buffer. Instead, only the number of bytes will be copied as can be placed in the FIFO before the FIFO becomes full. For example, if the FIFO has 10 bytes of space before being full and we wish to write 15 bytes of data, then 10 bytes will be copied to FIFO and we will be told that 10 bytes were copied. It is our responsibility on what we want to do with the remaining data that was not sent. Using `uart_write_bytes()` is arguably easier to work with.

Includes:

- `#include <driver/uart.h>`

See also:

- Working with UART/serial
- `uart_write_bytes`
- `uart_wait_tx_done`

### `uart_wait_tx_done`

Block / wait until the TX FIFO is empty.

```
esp_err_t uart_wait_tx_done(  
    uart_port_t uart_num,  
    TickType_t ticks_to_wait)
```

The `uart_no` is the identity of the UART being changed. It can be one of `UART_NUM_0`, `UART_NUM_1` or `UART_NUM_2`.

This call blocks/waits until the TX FIFO is empty. When empty, the return is `ESP_OK`. If we have timed out waiting for the TX FIFO to clear, we will get `ESP_ERR_TIMEOUT`. This function can be used in conjunction with `uart_tx_chars()` to write and validate that all data was sent.

Includes:

- `#include <driver/uart.h>`

See also:

- Working with UART/serial
- `uart_tx_chars`

## `uart_write_bytes`

Write bytes through the UART.

```
int uart_write_bytes(  
    uart_port_t uart_num,  
    const char* src,  
    size_t      size)
```

The `uart_no` is the identity of the UART being written to. It can be one of `UART_NUM_0`, `UART_NUM_1` or `UART_NUM_2`.

Here we write data through the UART. The number of bytes to be written is specified by `size`. That number of bytes will be read starting at the memory location pointed to by `src`. They will then be queued and transmitted.

The return is the number of bytes pushed to the transmission queue.

Includes:

- `#include <driver/uart.h>`

See also:

- Working with UART/serial
- `uart_read_bytes`
- `uart_tx_chars`

## uart\_write\_bytes\_with\_break

```
int uart_write_bytes_with_break(  
    uart_port_t uart_num,  
    const char* src,  
    size_t      size,  
    int         brk_len)
```

The `uart_no` is the identity of the UART being changed. It can be one of `UART_NUM_0`, `UART_NUM_1` or `UART_NUM_2`.

Includes:

- `#include <driver/uart.h>`

See also:

- Working with UART/serial

## UART low level APIs

`uartAttach`

`Uart_Init`

`uart_div_modify`

`uart_buff_switch`

`uart_tx_switch`

`uart_baudrate_detect`

`uart_rx_one_char`

Retrieve a character from the RX FIFO buffer if one is available.

```
STATUS uart_rx_one_char(uint8_t *rxChar)
```

Retrieve a single character from the serial input buffer. If a character was available, the return value is `OK` else it is `FAIL`. If a character was retrieved, it will be stored in `rxChar`.

Includes:

- `#include <rom/uart.h>`

See also:

- Working with UART/serial

## uart\_tx\_wait\_idle

## uart\_tx\_flush

```
void uart_tx_flush(uint8_t uartNumber)
```

## uart\_tx\_one\_char

```
STATUS uart_tx_one_char(uint8_t txChar)
```

Output a char to printf channel.

Includes:

- rom/uart.h

## uart\_tx\_one\_char2

## I2C APIs

See also:

- Using the ESP-IDF I2C driver
- C++ I2C Interaction

## i2c\_cmd\_link\_create

Create a command handle.

```
i2c_cmd_handle_t i2c_cmd_link_create()
```

The `i2c_cmd_handle_t` is an opaque data type and should be treated as such. Think of a command as a "future" request to send a message over the I2C bus. Because I2C is timing dependent, what we want to do is first build the message we wish to send and then actually send it. The thinking here is that if we were to build and send simultaneously, any interrupts that occurred would cause timing problems. In addition, the ESP32 has built-in hardware support for I2C transmissions but only if we can give it a "unit of transmission" as an atomic operation. The high level of operation is:

```
i2c_cmd_handle_t cmd = i2c_cmd_link_create();
i2c_master_start(cmd);
i2c_master_write_byte(cmd, (0x12 << 1) | I2C_MASTER_WRITE, 1 /* expect ack */);
i2c_master_write_byte(cmd, 0x34, 1);
i2c_master_stop(cmd);
i2c_master_cmd_begin(0, cmd, 0);
i2c_cmd_link_delete(cmd);
```

Note that we should create a `cmd_handle`, work with it and then delete it. Although not specified in the documentation, tests seem to show that once used, it should not be used again.

Includes:

- `#include <driver/i2c.h>`

See also:

- `i2c_master_cmd_begin`
- `i2c_cmd_link_delete`

### **`i2c_cmd_link_delete`**

```
void i2c_cmd_link_delete(i2c_cmd_handle_t cmd_handle)
```

Includes:

- `#include <driver/i2c.h>`

See also:

- `i2c_cmd_link_create`

### **`i2c_driver_delete`**

Delete a driver previously installed with `i2c_driver_install()`.

```
esp_err_t i2c_driver_delete(i2c_port_t i2c_num)
```

The `i2c_num` can be one of:

- `I2C_NUM_0`
- `I2C_NUM_1`

Includes:

- `#include <driver/i2c.h>`

### **`i2c_driver_install`**

Install the I2C driver.

```
esp_err_t i2c_driver_install(  
    i2c_port_t i2c_num,  
    i2c_mode_t mode,  
    size_t     slv_rx_buf_len,  
    size_t     slv_tx_buf_len,  
    int        intr_alloc_flags)
```

The `i2c_num` can be one of:

- I2C\_NUM\_0
- I2C\_NUM\_1

The `mode` can be one of:

- I2C\_MODE\_SLAVE
- I2C\_MODE\_MASTER

The `slv_rx_buf_len` defines the buffer for receiving if we are a slave.

The `slv_tx_buf_len` defines the buffer for transmitting if we are a slave.

The `intr_alloc_flags` can be 0.

Includes:

- `#include <driver/i2c.h>`

See also:

- `i2c_driver_delete`
- `i2c_param_config`

### **i2c\_get\_data\_mode**

```
esp_err_t i2c_get_data_mode(
    i2c_port_t      i2c_num,
    i2c_trans_mode_t* tx_trans_mode,
    i2c_trans_mode_t* rx_trans_mode)
```

The `i2c_num` can be one of:

- I2C\_NUM\_0
- I2C\_NUM\_1

Includes:

- `#include <driver/i2c.h>`

### **i2c\_get\_data\_timing**

```
esp_err_t i2c_get_data_timing(
    i2c_port_t i2c_num,
    int*      sample_time,
    int*      hold_time)
```

The `i2c_num` can be one of:

- I2C\_NUM\_0
- I2C\_NUM\_1

Includes:

- `#include <driver/i2c.h>`

### **i2s\_get\_period**

```
esp_err_t i2c_get_period(  
    i2c_port_t i2c_num,  
    int*       high_period,  
    int*       low_period)
```

The `i2c_num` can be one of:

- I2C\_NUM\_0
- I2C\_NUM\_1

Includes:

- `#include <driver/i2c.h>`

### **i2c\_get\_start\_timing**

```
esp_err_t i2c_get_start_timing(  
    i2c_port_t i2c_num,  
    int*       setup_time,  
    int*       hold_time)
```

The `i2c_num` can be one of:

- I2C\_NUM\_0
- I2C\_NUM\_1

Includes:

- `#include <driver/i2c.h>`

### **i2c\_get\_stop\_timing**

```
esp_err_t i2c_get_stop_timing(  
    i2c_port_t i2c_num,  
    int*       setup_time,  
    int*       hold_time)
```

The `i2c_num` can be one of:

- I2C\_NUM\_0



- I2C\_NUM\_1

Includes:

- driver/i2c.h

### **i2c\_isr\_free**

```
esp_err_t i2c_isr_free(intr_handle_t handle)
```

Includes:

- #include <driver/i2c.h>

### **i2c\_isr\_register**

```
esp_err_t i2c_isr_register(
    i2c_port_t      i2c_num,
    void (*fn)(void*),
    void*          arg,
    int            intr_alloc_flags,
    intr_handle_t* handle)
```

The `i2c_num` can be one of:

- I2C\_NUM\_0
- I2C\_NUM\_1

Includes:

- #include <driver/i2c.h>

### **i2c\_master\_cmd\_begin**

Process an I2C sequence of commands.

```
esp_err_t i2c_master_cmd_begin(
    i2c_port_t      i2c_num,
    i2c_cmd_handle_t cmd_handle,
    portBASE_TYPE  ticks_to_wait)
```

The `i2c_num` can be one of:

- I2C\_NUM\_0
- I2C\_NUM\_1

The `cmd_handle` should be a `cmd_handle` that has been previously created and then populated with the I2C commands/data to execute.

The return codes include:

- `ESP_OK (0)` – Command stream processed.
- `ESP_ERR_INVALID_ARG (0x102)` – Invalid parameter.
- `ESP_FAIL (-1)` – Command error; no ACK received from slave device.
- `ESP_ERR_INVALID_STATE (0x103)` – Driver not installed or not an I2C master.
- `ESP_ERR_TIMEOUT (0x107)` – Timed out because the bus was busy.

Includes:

- `#include <driver/i2c.h>`

See also:

- `i2c_cmd_link_create`
- `i2c_master_write`
- `i2c_master_write_byte`

## `i2c_master_read`

Read a sequence of bytes.

```
esp_err_t i2c_master_read(  
    i2c_cmd_handle_t cmd_handle,  
    uint8_t* data,  
    size_t data_len,  
    i2c_ack_type_t ack)
```

The `cmd_handle` is a handle that was previously created with an `i2c_cmd_link_create()` call.

The `data` is a buffer into which the read I2C bytes will be stored.

The `data_len` is the number of bytes we wish to read from the I2C.

The `ack` is a value which indicates whether or not the ESP32 should respond with an I2C ACK upon reading a byte. Take care here. The values can be:

- `I2C_MASTER_ACK`
- `I2C_MASTER_NACK`
- `I2C_MASTER_LAST_NACK`

Includes:

- `#include <driver/i2c.h>`

## **i2c\_master\_read\_byte**

Read a byte from the I2C bus.

```
esp_err_t i2c_master_read_byte(  
    i2c_cmd_handle_t cmd_handle,  
    uint8_t* data,  
    i2c_ack_type_t ack)
```

The `cmd_handle` is a handle that was previously created with an `i2c_cmd_link_create()` call.

The `data` is a buffer into which the read I2C byte will be stored.

The `ack` is a flag which indicates whether or not the ESP32 should respond with an I2C ACK upon reading a byte. The values can be:

- I2C\_MASTER\_ACK
- I2C\_MASTER\_NACK
- I2C\_MASTER\_LAST\_NACK

Includes:

- `#include <driver/i2c.h>`

## **i2c\_master\_start**

Queue command for I2C master to generate a start signal.

```
esp_err_t i2c_master_start(i2c_cmd_handle_t cmd_handle)
```

The start signal is used at the beginning of an I2C transmission and is followed by the address of the slave with which we wish to communicate. For example in the following we create a command stream, indicate that we are starting a new transaction and then supply the address. Note that an address is 7 bits of address data plus an indication of whether it is a read or write request we are making.

```
i2c_cmd_handle_t cmd = i2c_cmd_link_create();  
i2c_master_start(cmd);  
i2c_master_write_byte(cmd, (0x12 << 1) | I2C_MASTER_WRITE, 1 /* expect ack */);
```

Includes:

- `#include <driver/i2c.h>`

See also:

- `i2c_master_cmd_begin`

## i2c\_master\_stop

Queue the command to indicate an I2C protocol stop.

```
esp_err_t i2c_master_stop(i2c_cmd_handle_t cmd_handle)
```

Includes:

- `#include <driver/i2c.h>`

## i2c\_master\_write

Write a sequence of bytes as a master.

```
esp_err_t i2c_master_write(  
    i2c_cmd_handle_t cmd_handle,  
    uint8_t* data,  
    size_t data_len,  
    bool ack_en)
```

The `data` is a pointer to the buffer of data to send. This data is **not** copied and must be preserved until after a transmission using `i2c_master_cmd_begin()`.

The `data_len` is the length of the data to send.

The `ack_en` is used to flag whether we are looking for an acknowledgment. When the master (the ESP32) transmits 8 bits of data, we should expect to see the slave acknowledge receipt. Setting the `ack_en` flag to true causes the driver to validate that the transmission worked. Setting it to false bypasses any check for an acknowledgment.

Includes:

- `#include <driver/i2c.h>`

## i2c\_master\_write\_byte

Write a byte as a master.

```
esp_err_t i2c_master_write_byte(  
    i2c_cmd_handle_t cmd_handle,  
    uint8_t data,  
    bool ack_en)
```

The `data` is the byte to write.

The `ack_en` is used to flag whether we are looking for an acknowledgment. When the master (the ESP32) transmits 8 bits of data, we should expect to see the slave acknowledge receipt. Setting the `ack_en` flag to true causes the driver to validate that the transmission worked. Setting it to false bypasses any check for an acknowledgment.

Includes:

- `#include <driver/i2c.h>`

### **i2c\_param\_config**

```
esp_err_t i2c_param_config(  
    i2c_port_t i2c_num,  
    i2c_config_t* i2c_conf)
```

The `i2c_num` can be one of:

- `I2C_NUM_0`
- `I2C_NUM_1`

The `i2c_conf` is a structure containing:

- `i2c_mode_t mode` – One of
  - `I2C_MODE_SLAVE`
  - `I2C_MODE_MASTER`
- `gpio_num_t sda_io_num`
- `gpio_pullup_t sda_pullup_en`
- `gpio_num_t scl_io_num`
- `gpio_pullup_t scl_pullup_en`
- `master`
  - `uint32_t clk_speed`
- `slave`
  - `uint8_t addr_10bit_en`
  - `uint16_t slave_addr`

Includes:

- `#include <driver/i2c.h>`

See also:

- `i2c_driver_install`

### **i2c\_reset\_rx\_fifo**

```
esp_err_t i2c_reset_rx_fifo(i2c_port_t i2c_num)
```

The `i2c_num` can be one of:

- `I2C_NUM_0`
- `I2C_NUM_1`

Includes:

- `#include <driver/i2c.h>`

### **`i2c_reset_tx_fifo`**

```
esp_err_t i2c_reset_tx_fifo(i2c_port_t i2c_num)
```

The `i2c_num` can be one of:

- `I2C_NUM_0`
- `I2C_NUM_1`

Includes:

- `#include <driver/i2c.h>`

### **`i2c_set_data_mode`**

```
esp_err_t i2c_set_data_mode(  
    i2c_port_t      i2c_num,  
    i2c_trans_mode_t tx_trans_mode,  
    i2c_trans_mode_t rx_trans_mode)
```

The `i2c_num` can be one of:

- `I2C_NUM_0`
- `I2C_NUM_1`

Both the `tx_trans_mode` and `rx_trans_mode` can be one of:

- `I2C_DATA_MODE_MSB_FIRST`
- `I2C_DATA_MODE_LSB_FIRST`

Includes:

- `#include <driver/i2c.h>`

### **`i2c_set_data_timing`**

```
esp_err_t i2c_set_data_timing(  
    i2c_port_t i2c_num,
```

```
int      sample_time,  
int      hold_time)
```

The `i2c_num` can be one of:

- `I2C_NUM_0`
- `I2C_NUM_1`

Includes:

- `#include <driver/i2c.h>`

### `i2c_set_period`

```
esp_err_t i2c_set_period(  
    i2c_port_t i2c_num,  
    int        high_period,  
    int        low_period)
```

The `i2c_num` can be one of:

- `I2C_NUM_0`
- `I2C_NUM_1`

Includes:

- `#include <driver/i2c.h>`

### `i2c_set_pin`

Change the pins used for I2C.

```
esp_err_t i2c_set_pin(  
    i2c_port_t i2c_num,  
    gpio_num_t sda_io_num,  
    gpio_num_t scl_io_num,  
    gpio_pullup_t sda_pullup_en,  
    gpio_pullup_t scl_pullup_en,  
    i2c_mode_t mode)
```

The `i2c_num` can be one of:

- `I2C_NUM_0`
- `I2C_NUM_1`

Includes:

- `#include <driver/i2c.h>`

### **i2c\_set\_start\_timing**

```
esp_err_t i2c_set_start_timing(  
    i2c_port_t i2c_num,  
    int        setup_time,  
    int        hold_time)
```

The `i2c_num` can be one of:

- `I2C_NUM_0`
- `I2C_NUM_1`

Includes:

- `#include <driver/i2c.h>`

### **i2c\_set\_stop\_timing**

```
esp_err_t i2c_set_stop_timing(  
    i2c_port_t i2c_num,  
    int        setup_time,  
    int        hold_time)
```

The `i2c_num` can be one of:

- `I2C_NUM_0`
- `I2C_NUM_1`

Includes:

- `#include <driver/i2c.h>`

### **i2c\_slave\_read\_buffer**

```
int i2c_slave_read_buffer(  
    i2c_port_t i2c_num,  
    uint8_t*   data,  
    size_t    max_size,  
    portBASE_TYPE ticks_to_wait)
```

The `i2c_num` can be one of:

- `I2C_NUM_0`
- `I2C_NUM_1`

Includes:

- `#include <driver/i2c.h>`



## **i2c\_slave\_write\_buffer**

```
int i2c_slave_write_buffer(  
    i2c_port_t    i2c_num,  
    uint8_t*     data,  
    int          size,  
    portBASE_TYPE ticks_to_wait)
```

The `i2c_num` can be one of:

- `I2C_NUM_0`
- `I2C_NUM_1`

Includes:

- `#include <driver/i2c.h>`

## **SPI APIs**

The ESP-IDF provides a driver for the SPI interface.

See also:

- Using the ESP-IDF SPI driver

## **spi\_bus\_add\_device**

Define a new device to SPI.

```
esp_err_t spi_bus_add_device(  
    spi_host_device_t    host,  
    spi_device_interface_config_t* dev_config,  
    spi_device_handle_t* handle)
```

When we wish to interact with a device, we need to describe it to our environment. This returns a handle which we can subsequently use. When we no longer need the device, we can release resources associated with it via a call to `spi_bus_remove_device()`.

Core within the characteristics that are supplied with this call are the clock speed with which we will use when communicating and, if needed, which pin we want to use for slave select (CS). The queue size must also be supplied and must be at least 1.

Host can be one of:

- `SPI_HOST (0)` – Do not use.
- `HSPI_HOST (1)`

- `VSPI_HOST` (2)

The `dev_config` is a structure that contains:

- `uint8_t address_bits` – Number of bits to send in address action (0-64).
- `uint8_t command_bits` – Number of bits to send in command action (0-16).
- `uint8_t dummy_bits` – Number of filler bits to send between address and data.
- `uint8_t mode` – SPI mode (0-3)
- `uint8_t duty_cycle_pos` – default 0.
- `uint8_t cs_ena_pretrans` – Number of bit cycles CS should be activated before transmission.
- `uint8_t cs_ena_posttrans` – Number of bit cycles CS should stay active after transmission.
- `int clock_speed_hz` – Clock speed in Hz.
- `int spics_io_num` – CS gpio pin for device or -1 if not used.
- `uint32_t flags` – Bitwise OR of `SPI_DEVICE_*` flags.
  - `SPI_DEVICE_TXBIT_LSBFIRST`
  - `SPI_DEVICE_RXBIT_LSBFIRST`
  - `SPI_DEVICE_3WIRE`
  - `SPI_DEVICE_POSITIVE_CS`
  - `SPI_DEVICE_HALFDUPLEX`
  - `SPI_DEVICE_CLK_AS_CS`
- `int queue_size` – Transaction queue size. This is the number of concurrent SPI requests that may be in flight at one time. It must be at least 1.
- `transaction_cb_t pre_cb` – Callback function to be invoked before a transmission is started.
- `transaction_cb_t post_cb` – Callback function to be invoked after a transmission has completed.

The `handle` is the handle you can subsequently use for interacting with the device.

Includes:

- `#include <driver/spi_master.h>`

See also:

- `spi_bus_initialize`

- `spi_bus_remove_device`

## **spi\_bus\_free**

Free up a bus.

```
esp_err_t spi_bus_free(spi_host_device_t host)
```

The `host` can be one of:

- `SPI_HOST (0)` – Do not use.
- `HSPI_HOST (1)`
- `VSPI_HOST (2)`

Includes:

- `#include <driver/spi_master.h>`

See also:

- `spi_bus_initialize`

## **spi\_bus\_initialize**

Initialize an SPI Bus.

```
esp_err_t spi_bus_initialize(  
    spi_host_device_t host,  
    spi_bus_config_t* bus_config,  
    int dma_chan)
```

The ESP32 provides multiple SPI bus instances. We use this API to initialize one of these buses. A bus is typically initialized only once during the life of an ESP32 application. Primarily, the initialization identifies the externalized GPIO pins that will be used for the SPI functions core of which are CLK, MOSI and MISO.

Host can be one of:

- `SPI_HOST (0)` – Do not use. Used internally.
- `HSPI_HOST (1)`
- `VSPI_HOST (2)`

The `bus_config` is a structure containing:

- `int mosi_io_num` – GPIO for MOSI or -1 if not used.
- `int miso_io_num` – GPIO for MISO or -1 if not used.

- `int sclk_io_num` – GPIO pin for CLK or -1 if not used.
- `int quadwp_io_num` – Specify -1 if not used.
- `int quadhd_io_num` – Specify -1 if not used.
- `int max_transfer_size` – Maximum transfer size in bytes. Defaults to 4094 if 0.

The `dma_chan` is which of the two possible DMA channels to use ... either 1 or 2.

Includes:

- `#include <driver/spi_master.h>`

See also:

- `spi_bus_free`
- `spi_bus_add_device`

### **spi\_bus\_remove\_device**

Release the resources of a previously registered device.

```
esp_err_t spi_bus_remove_device(spi_device_handle_t handle)
```

This function can be called to release the resources allocated by a previous call to `spi_bus_add_device()`. Following this call, no further transmission requests should be made using the now defunct handle.

Includes:

- `#include <driver/spi_master.h>`

See also:

- `spi_bus_add_device`

### **spi\_device\_get\_trans\_result**

Retrieve results from previous queued transmissions.

```
esp_err_t spi_device_get_trans_result(
    spi_device_handle_t handle,
    spi_transaction_t **trans_desc,
    TickType_t ticks_to_wait)
```

When we invoke `spi_device_queue_trans()` we are requesting a transmission to occur at some time in the future. Ideally as soon as possible. This function retrieves (if available) the results from previously queued transmissions.

Includes:

- `#include <driver/spi_master.h>`

See also:

- `spi_device_queue_trans`
- `spi_device_transmit`

## `spi_device_queue_trans`

Queue a request for transmission.

```
esp_err_t spi_device_queue_trans(
    spi_device_handle_t handle,
    spi_transaction_t* trans_desc,
    TickType_t ticks_to_wait)
```

This function indicates that we have a transmission to be executed against an SPI device but that we don't need to wait for a response. Rather the request will be executed when it can and the response will subsequently be available for retrieval using the function `spi_device_get_trans_result()`.

The `trans_desc` is a description of a transaction. It contains:

- `uint32_t flags` – Bit wise OR of the `SPI_TRANS_*` flags:
  - `SPI_MODE_DIO`
  - `SPI_MODE_QIO`
  - `SPI_MODE_DIOQIO_ADDR`
  - `SPI_USE_RXDATA`
  - `SPI_USE_TXDATA`
- `uint16_t command` – Command data. Number of bits sent is defined by `commands_bits` value defined in `spi_device_interface_config_t`.
- `uint64_t address` – Address data. Number of bits sent is defined by `address_bits` value defined in `spi_device_interface_config_t`.
- `size_t length` – Total data length to send and receive in bits.
- `size_t rxlength` – Length of data to receive (in bits). If 0 is supplied, then we use the what ever value is defined in `length`.
- `void *user` – User defined context data.
- A union of:
  - `const void *tx_buffer` – Pointer to data used to hold data to be transmitted.

- `uint8_t tx_data[4]` – Used if `SPI_USE_TXDATA` is flagged.
- A union of:
  - `void *rx_buffer` – Pointer to data used to hold data received.
  - `uint8_t rx_data[4]` – Used if `SPI_USE_RXDATA` is flagged.

Includes:

- `#include <driver/spi_master.h>`

See also:

- `spi_device_get_trans_result`
- `spi_device_transmit`

### `spi_device_transmit`

Perform a transmission over the SPI bus and wait for a response.

```
esp_err_t spi_device_transmit(
    spi_device_handle_t handle,
    spi_transaction_t* trans_desc)
```

Logically, this function is an amalgamation of `esp_device_queue_trans()` followed by a call to `spi_device_get_trans_result()` effectively resulting in a synchronous request and block for response of an SPI request.

The `trans_desc` is a description of a transaction. It contains:

- `uint32_t flags` – Bit wise OR of the `SPI_TRANS_*` flags:
  - `SPI_MODE_DIO`
  - `SPI_MODE_QIO`
  - `SPI_MODE_DIOQIO_ADDR`
  - `SPI_USE_RXDATA`
  - `SPI_USE_TXDATA`
- `uint16_t command` – Command data. Number of bits sent is defined by `command_bits` value defined in `spi_device_interface_config_t`.
- `uint64_t address` – Address data. Number of bits sent is defined by `address_bits` value defined in `spi_device_interface_config_t`.
- `size_t length` – Total data length to send and receive in bits. **Note:** The size is in bits ... **not** bytes.
- `size_t rxlength` – Length of data to receive (in bits). If 0 is supplied, then we use the what ever value is defined in `length`.

- `void *user` – User defined context data.
- A union of:
  - `const void *tx_buffer` – Pointer to data used to hold data to be transmitted.
  - `uint8_t tx_data[4]` – Used if `SPI_USE_TXDATA` is flagged.
- A union of:
  - `void *rx_buffer` – Pointer to data used to hold data received.
  - `uint8_t rx_data[4]` – Used if `SPI_USE_RXDATA` is flagged.

For example:

```
char data[3];
spi_transaction_t trans_desc;
trans_desc.address = 0;
trans_desc.command = 0;
trans_desc.flags = 0;
trans_desc.length = 3 * 8;
trans_desc.rxlenght = 0;
trans_desc.tx_buffer = data;
trans_desc.rx_buffer = data;
```

```
data[0] = 0x12;
data[1] = 0x34;
data[2] = 0x56;
```

```
ESP_ERROR_CHECK(spi_device_transmit(handle, &trans_desc));
```

Includes:

- `#include <driver/spi_master.h>`

See also:

- `spi_device_get_trans_result`
- `spi_device_queue_trans`

## I2S APIs

See also:

- I2S – DMA

### `i2s_adc_enable`

```
esp_err_t i2s_adc_enable(i2s_port_t i2s_num)
```

### `i2s_adc_disable`

```
esp_err_t i2s_adc_disable(i2s_port_t i2s_num)
```

## **i2s\_driver\_install**

```
esp_err_t i2s_driver_install(  
    i2s_port_t          i2s_num,  
    const i2s_config_t* i2s_config,  
    int                 queue_size,  
    void*               i2s_queue)
```

## **i2s\_driver\_uninstall**

```
esp_err_t i2s_driver_uninstall(i2s_port_t i2s_num)
```

## **i2s\_pop\_sample**

```
int i2s_pop_sample(  
    i2s_port_t i2s_num,  
    char*      sample,  
    TickType_t ticks_to_wait);
```

## **i2s\_push\_sample**

```
int i2s_push_sample(  
    i2s_port_t i2s_num,  
    const char* sample,  
    TickType_t ticks_to_wait)
```

## **i2s\_read\_bytes**

```
int i2s_read_bytes(  
    i2s_port_t i2s_num,  
    char*      dest,  
    size_t     size,  
    TickType_t ticks_to_wait);
```

## **i2s\_set\_adc\_mode**

```
esp_err_t i2s_set_adc_mode(  
    adc_unit_t      adc_unit,  
    adc1_channel_t adc_channel)
```

## **i2s\_set\_clk**

```
esp_err_t i2s_set_clk(  
    i2s_port_t          i2s_num,  
    uint32_t           rate,  
    i2s_bits_per_sample_t bits,  
    i2s_channel_t      ch)
```

## **i2s\_set\_dac\_mode**

```
esp_err_t i2s_set_dac_mode(i2s_dac_mode_t dac_mode)
```

## **i2s\_set\_pin**

```
esp_err_t i2s_set_pin(  
    i2s_port_t          i2s_num,  
    const i2s_pin_config_t* pin)
```



### **i2s\_set\_sample\_rates**

```
esp_err_t i2s_set_sample_rates(  
    i2s_port_t i2s_num,  
    uint32_t rate)
```

### **i2s\_start**

```
esp_err_t i2s_start(i2s_port_t i2s_num)
```

### **i2s\_stop**

```
esp_err_t i2s_stop(i2s_port_t i2s_num)
```

### **i2s\_write\_bytes**

```
int i2s_write_bytes(  
    i2s_port_t i2s_num,  
    const char* src,  
    size_t size,  
    TickType_t ticks_to_wait);
```

### **i2s\_write\_expand**

```
int i2s_write_expand(  
    i2s_port_t i2s_num,  
    const char* src,  
    int size,  
    int src_bits,  
    int aim_bits,  
    TickType_t ticks_to_wait)
```

### **i2s\_zero\_dma\_buffer**

```
esp_err_t i2s_zero_dma_buffer(i2s_port_t i2s_num);
```

## **RMT APIs**

The RMT component is the "remote" controller. The word "remote" here means a remote control such as you would find for controlling your TV or stereo. The primary function is to create complex digital wave forms that will drive infrared LEDs to generate a PWM signal in the infrared spectrum. However, we can attach other signal consuming devices to the output of this data to drive them. A good example is neopixels.

See also:

- [Remote Control Peripheral – RMT](#)

### **rmt\_clr\_intr\_enable\_mask**

Clear mask value to RMT interrupt enable register.

```
void rmt_clr_intr_enable_mask(uint32_t mask)
```

- `mask` – Bit mask to clear the register.

Includes:

- `#include <driver/rmt.h>`

## **rmt\_config**

```
esp_err_t rmt_config(rmt_config_t* rmt_param)
```

Configure an RMT channel. The `rmt_param` is a rich structure containing:

- `rmt_mode` (`rmt_mode_t`) – This can be one of
  - `RMT_MODE_TX` – Configure this channel for output (transmission).
  - `RMT_MODE_RX` – Configure this channel for input (reception).
- `channel` (`rmt_channel_t`) – A value between `RMT_CHANNEL_0` and `RMT_CHANNEL_7`.
- `clk_div` (`uint8_t`) – The clock divider value. If the base clock is 80MHz then a divisor of 8 gives us 10MHz, a divisor of 80 gives us 1MHz.
- `gpio_num` (`gpio_num_t`) – The gpio number associated with the function.
- `mem_block_num` (`uint8_t`) – Memory block number.
- Union of
  - `tx_config` – Configuration for transmission.
    - `loop_en` (`bool`) – True if loop output mode.
    - `carrier_en` (`bool`) – Is the carrier enabled.
    - `carrier_freq_hz` (`uint32_t`) – Carrier frequency.
    - `carrier_duty_percent` (`uint8_t`)
    - `carrier_level` (`rmt_carrier_level_t`) – One of:
      - `RMT_CARRIER_LEVEL_LOW`
      - `RMT_CARRIER_LEVEL_HIGH`
    - `idle_output_en` (`bool`) – Idle level output enabled.
    - `idle_level` (`rmt_idle_level_t`) – The signal level when idle. One of:
      - `RMT_IDLE_LEVEL_LOW`
      - `RMT_IDLE_LEVEL_HIGH`
  - `rx_config` – Configuration information for input reception.

- `filter_en (bool)` – Should signal filtering be enabled.
- `filter_ticks_thresh (uint8_t)` – If signal filtering is enabled, this is the threshold below which transitions will be ignored.
- `idle_threshold (uint16_t)` – The duration of idleness after which the signal train will be considered complete. If we have a clock div of 255 (the maximum) and a threshold of 65535 (the maximum), this gives us a maximum idle period duration of about 209 msecs.

Includes:

- `#include <driver/rmt.h>`

### **rmt\_driver\_install**

Initialize the RMT driver.

```
esp_err_t rmt_driver_install(
    rmt_channel_t channel,
    size_t rx_buf_size,
    int intr_alloc_flags)
```

- `channel` – The channel to initialize. A value between `RMT_CHANNEL_0` and `RMT_CHANNEL_7`.
- `size` – The size of the RMT channel ring buffer. Can be 0.
- `intr_alloc_flags` – Normally 0.

Includes:

- `#include <driver/rmt.h>`

### **rmt\_driver\_uninstall**

Uninstall the RMT driver.

```
esp_err_t rmt_driver_uninstall(rmt_channel_t channel)
```

- `channel` – The channel to un-install. A value between `RMT_CHANNEL_0` and `RMT_CHANNEL_7`.

Includes:

- `#include <driver/rmt.h>`

## rmt\_fill\_tx\_items

```
esp_err_t rmt_fill_tx_items(  
    rmt_channel_t channel,  
    rmt_item32_t* item,  
    uint16_t item_num,  
    uint16_t mem_offset)
```

- `channel` – A value between `RMT_CHANNEL_0` and `RMT_CHANNEL_7`.
- `item` – Pointer to items.
- `item_num` – Number of items.
- `mem_offset` – Offset into memory

Includes:

- `#include <driver/rmt.h>`

## rmt\_get\_clk\_div

Get the RMT clock divider.

```
esp_err_t rmt_get_clk_div(  
    rmt_channel_t channel,  
    uint8_t* div_cnt)
```

- `channel` – A value between `RMT_CHANNEL_0` and `RMT_CHANNEL_7`.
- `div_cnt` – The divider of the base clock which is 80MHz.

Includes:

- `#include <driver/rmt.h>`

See also:

- `rmt_set_clk_div`

## rmt\_get\_mem\_block\_num

Get the number of memory blocks used by this channel.

```
esp_err_t rmt_get_mem_block_num(  
    rmt_channel_t channel,  
    uint8_t* rmt_mem_num)
```

- `channel` – A value between `RMT_CHANNEL_0` and `RMT_CHANNEL_7`.
- `rmt_mem_num` – A storage area that will be used to hold the number of memory blocks allocated to the channel.

Includes:

- `#include <driver/rmt.h>`

See also:

- `rmt_set_mem_block_num`

### **rmt\_get\_mem\_pd**

Get memory low power mode.

```
esp_err_t rmt_get_mem_pd(rmt_channel_t channel, bool* pd_en)
```

- `channel` – A value between `RMT_CHANNEL_0` and `RMT_CHANNEL_7`.
- `pd_en` – Pointer to receive the memory low power mode.

Includes:

- `#include <driver/rmt.h>`

### **rmt\_get\_memory\_owner**

Get the memory owner of a channel's memory block.

```
esp_err_t rmt_get_memory_owner(
    rmt_channel_t channel,
    rmt_mem_owner_t* owner)
```

- `channel` – A value between `RMT_CHANNEL_0` and `RMT_CHANNEL_7`.
- `owner` – A storage area that will be filled in with the owner of the memory block.  
One of:
  - `RMT_MEM_OWNER_TX`
  - `RMT_MEM_OWNER_RX`.

Includes:

- `#include <driver/rmt.h>`

### **rmt\_get\_ringbuf\_handle**

Get the ring-buffer handler.

```
esp_err_t rmt_get_ringbuf_handle(
    rmt_channel_t channel,
    RingbufHandle_t *buf_handle)
```

- `channel` – A value between `RMT_CHANNEL_0` and `RMT_CHANNEL_7`.

- `buf_handle` – A handle to the ring buffer.

Includes:

- `#include <driver/rmt.h>`
- `#include <freertos/ringbuf.h>`

### **rmt\_get\_rx\_idle\_thresh**

Get RMT idle threshold.

```
esp_err_t rmt_get_rx_idle_thresh(rmt_channel_t channel, uint16_t *thresh)
```

- `channel` – A value between `RMT_CHANNEL_0` and `RMT_CHANNEL_7`.
- `thresh` – A pointer to storage into which the RX idle threshold will be copied.

Includes:

- `#include <driver/rmt.h>`

### **rmt\_get\_status**

Get RMT status.

```
esp_err_t rmt_get_status(rmt_channel_t channel, uint32_t* status)
```

- `channel`
- `status`

Includes:

- `#include <driver/rmt.h>`

### **rmt\_get\_source\_clk**

Get the source clock.

```
esp_err_t rmt_get_source_clk(  
    rmt_channel_t channel,  
    rmt_source_clk_t* src_clk)
```

- `channel` – A value between `RMT_CHANNEL_0` and `RMT_CHANNEL_7`.
- `src_clk` – The source of the clock. One of:
  - `RMT_BASECLK_REF` – A 1MHz clock (not supported).
  - `RMT_BASECLK_APB` – The APB clock at 80MHz.

Includes:

- `#include <driver/rmt.h>`

### **rmt\_get\_tx\_loop\_mode**

Get tx loop mode.

```
esp_err_t rmt_get_tx_loop_mode(  
    rmt_channel_t channel,  
    bool* loop_en)
```

- `channel` – A value between `RMT_CHANNEL_0` and `RMT_CHANNEL_7`.
- `loop_en` – The current value of the loop transmission state.

Includes:

- `#include <driver/rmt.h>`

See also:

- `rmt_set_tx_loop_mode`

### **rmt\_isr\_deregister**

De-register a previously registered interrupt handler.

```
esp_err_t rmt_isr_deregister(rmt_isr_handle_t handle)
```

- `handle` – A handle returned from a previous call to `rmt_isr_register()`.

Includes:

- `#include <driver/rmt.h>`

See also:

- `rmt_isr_register`

### **rmt\_isr\_register**

Handler for ISR.

```
esp_err_t rmt_isr_register(  
    void (*fn)(void *), void * arg, int intr_alloc_flags, rmt_isr_handle_t *handle)
```

- `fn` – A function to be called when an interrupt occurs.
- `arg` – Parameters/context for the interrupt handler
- `intr_alloc_flags` – Interrupt allocation flags.

- `handle` – A handle returned used to refer to this registered interrupt handler.

The signature of the handler function is:

```
void func(void *args)
```

Includes:

- `#include <driver/rmt.h>`

See also:

- `rmt_isr_deregister`
- `rmt_clr_intr_enable_mask`
- `rmt_set_err_intr_en`
- `rmt_set_intr_enable_mask`
- `rmt_set_rx_intr_en`
- `rmt_set_tx_thr_intr_en`

### **rmt\_memory\_rw\_rst**

Reset TX/RX memory index.

```
esp_err_t rmt_memory_rw_rst(rmt_channel_t channel)
```

- `channel` – A value between `RMT_CHANNEL_0` and `RMT_CHANNEL_7`.

Includes:

- `#include <driver/rmt.h>`

### **rmt\_rx\_start**

Start receiving data.

```
esp_err_t rmt_rx_start(rmt_channel_t channel, bool rx_idx_rst)
```

- `channel` – A value between `RMT_CHANNEL_0` and `RMT_CHANNEL_7`.
- `rx_idx_rst` – Set to true to reset the receiver index.

Includes:

- `#include <driver/rmt.h>`

### **rmt\_rx\_stop**

Stop receiving data.

```
esp_err_t rmt_rx_stop(rmt_channel_t channel)
```



- `channel` – A value between `RMT_CHANNEL_0` and `RMT_CHANNEL_7`.

Includes:

- `#include <driver/rmt.h>`

### **rmt\_set\_clk\_div**

Set RMT clock divider.

```
esp_err_t rmt_set_clk_div(  
    rmt_channel_t channel,  
    uint8_t div_cnt)
```

- `channel` – A value between `RMT_CHANNEL_0` and `RMT_CHANNEL_7`.
- `div_cnt` – RMT counter clock divider.

Includes:

- `#include <driver/rmt.h>`

See also:

- `rmt_get_clk_div`

### **rmt\_set\_err\_intr\_en**

```
esp_err_t rmt_set_err_intr_en(rmt_channel_t channel, bool en)
```

Includes:

- `#include <driver/rmt.h>`

### **rmt\_set\_idle\_level**

```
esp_err_t rmt_set_idle_level(  
    rmt_channel_t channel,  
    bool idle_out_en,  
    rmt_idle_level_t level)
```

- `idle_out_en` – Should an idle level be set.
- `level` – The idle level. One of:
  - `RMT_IDLE_LEVEL_LOW` – The value for a low level.
  - `RMT_IDLE_LEVEL_HIGH` – The value for a high level.

Includes:

- `#include <driver/rmt.h>`

### **rmt\_set\_intr\_enable\_mask**

`void rmt_set_intr_enable_mask(uint32_t mask)`

Includes:

- `#include <driver/rmt.h>`

### **rmt\_set\_mem\_block\_num**

Set the number of adjacent memory blocks used by the channel.

```
esp_err_t rmt_set_mem_block_num(  
    rmt_channel_t channel,  
    uint8_t blockCount)
```

- `channel` – A value between `RMT_CHANNEL_0` and `RMT_CHANNEL_7`.
- `blockCount` – The number of memory blocks associated with the channel. Between 1 and 8.

Includes:

- `#include <driver/rmt.h>`

See also:

- `rmt_get_mem_block_num`

### **rmt\_set\_mem\_pd**

Set RMT memory in low power mode.

```
esp_err_t rmt_set_mem_pd(rmt_channel_t channel, bool pd_en)
```

Includes:

- `#include <driver/rmt.h>`

### **rmt\_set\_memory\_owner**

Set the memory owner of a channels memory block.

```
esp_err_t rmt_set_memory_owner(  
    rmt_channel_t channel,  
    rmt_mem_owner_t owner)
```

- `channel` – The type of owner of the memory block associated with the channel.

- `owner` – One of `RMT_MEM_OWNER_TX` or `RMT_MEM_OWNER_RX`.

Includes:

- `#include <driver/rmt.h>`

### **rmt\_set\_pin**

```
esp_err_t rmt_set_pin(  
    rmt_channel_t channel,  
    rmt_mode_t mode,  
    gpio_num_t gpio_num)
```

- `channel` – A value between `RMT_CHANNEL_0` and `RMT_CHANNEL_7`.
- `mode`
- `gpio_num`

Includes:

- `#include <driver/rmt.h>`

### **rmt\_set\_rx\_filter**

```
esp_err_t rmt_set_rx_filter(  
    rmt_channel_t channel,  
    bool rx_filter_en,  
    uint8_t thresh)
```

- `channel` – A value between `RMT_CHANNEL_0` and `RMT_CHANNEL_7`.
- `rx_filter_en` – true to enable input filtering and false to disable.
- `thresh` – The threshold in clock ticks below which incoming signals should be discarded.

Includes:

- `#include <driver/rmt.h>`

### **rmt\_set\_rx\_idle\_thresh**

Set the RMT RX idle threshold.

```
esp_err_t rmt_set_rx_idle_thresh(  
    rmt_channel_t channel,  
    uint16_t thresh)
```

- `channel` – A value between `RMT_CHANNEL_0` and `RMT_CHANNEL_7`.
- `thresh` – The value in clocks ticks where the lack of a transition indicates a return to idle mode.

Includes:

- `#include <driver/rmt.h>`

See also:

- `rmt_get_rx_idle_thresh`

### `rmt_set_rx_intr_en`

Enable or disable an interrupt for having received a signal train.

```
esp_err_t rmt_set_rx_intr_en(rmt_channel_t channel, bool en)
```

- `channel` – A value between `RMT_CHANNEL_0` and `RMT_CHANNEL_7`.
- `en` – True to enable the interrupt, false to disable.

Includes:

- `#include <driver/rmt.h>`

### `rmt_set_tx_carrier`

```
esp_err_t rmt_set_tx_carrier(
    rmt_channel_t channel,
    bool carrier_en,
    uint16_t high_level,
    uint16_t low_level,
    rmt_carrier_level_t carrier_level)
```

Includes:

- `#include <driver/rmt.h>`

### `rmt_set_tx_intr_en`

```
esp_err_t rmt_set_tx_intr_en(
    rmt_channel_t channel,
    bool en)
```

Includes:

- `#include <driver/rmt.h>`

See also:

- `rmt_set_err_intr_en`

- `rmt_set_rx_intr_en`
- `rmt_set_tx_thr_intr_en`

### `rmt_set_tx_loop_mode`

```
esp_err_t rmt_set_tx_loop_mode(
    rmt_channel_t channel,
    bool loop_en)
```

#### Includes:

- `#include <driver/rmt.h>`

#### See also:

- `rmt_get_tx_loop_mode`

### `rmt_set_tx_thr_intr_en`

```
esp_err_t rmt_set_tx_thr_intr_en_en(
    rmt_channel_t channel,
    bool en,
    uint16_t evt_thresh)
```

#### Includes:

- `#include <driver/rmt.h>`

### `rmt_set_source_clk`

Set the reference source clock.

```
esp_err_t rmt_set_source_clk(
    rmt_channel_t channel,
    rmt_source_clk_t base_clk)
```

- `channel` – A value between `RMT_CHANNEL_0` and `RMT_CHANNEL_7`.
- `base_clk` – The source of the clock. One of:
  - `RMT_BASECLK_REF` – A 1MHz clock (not supported).
  - `RMT_BASECLK_APB` – The APB clock at 80MHz.

#### Includes:

- `#include <driver/rmt.h>`

## rmt\_tx\_start

Start the channel transmitting.

```
esp_err_t rmt_tx_start(  
    rmt_channel_t channel,  
    bool tx_idx_rst)
```

- `channel` – The channel to start transmitting upon.
- `tx_idx_rst` – If true, the transmission will start at 1<sup>st</sup> memory block otherwise it will continue from where it was last stopped.

Includes:

- `#include <driver/rmt.h>`

## rmt\_tx\_stop

Stop the channel transmitting.

```
esp_err_t rmt_tx_stop(rmt_channel_t channel)
```

- `channel` – The channel to stop transmitting.

Includes:

- `#include <driver/rmt.h>`

## rmt\_wait\_tx\_done

```
esp_err_t rmt_wait_tx_done(rmt_channel_t channel)
```

Includes:

- `#include <driver/rmt.h>`

## rmt\_write\_items

Send wave forms.

```
esp_err_t rmt_write_items(  
    rmt_channel_t channel,  
    rmt_item32_t* rmt_item,  
    int item_num,  
    bool wait_tx_done)
```

- `channel` – The channel to transmit upon. A value between `RMT_CHANNEL_0` and `RMT_CHANNEL_7`.
- `rmt_item` – An array of items to transmit. This is a data type that is a union between:

- `uint32_t val` – The value of an item as a whole.
- **structure of:**
  - `uint32_t duration0` – The duration of the 1<sup>st</sup> part of the item.
  - `uint32_t level0` – The signal level of the 1<sup>st</sup> part of the item.
  - `uint32_t duration1` – The duration of the 2<sup>nd</sup> part of the item.
  - `uint32_t level1` – The signal level of the 2<sup>nd</sup> part of the item.
- `item_num` – Number of items to transmit.
- `wait_tx_done` – If true, will wait for transmission to complete.

It is vital to note that the array of items passed in is **not** copied. Instead the data is used for the duration of the writing. As such one can't release or otherwise modify the data until after the write is complete.

Includes:

- `#include <driver/rmt.h>`

## LEDC/PWM APIs

This section discusses the driver APIs for the LEDC / PWM access.

See also:

- LEDC – Pulse Width Modulation – PWM

### `ledc_bind_channel_timer`

```
esp_err_t ledc_bind_channel_timer(
    ledc_mode_t speedMode,
    uint32_t channel,
    uint32_t timerIdx)
```

Currently, `speedMode` can only be `LEDC_HIGH_SPEED_MODE`.

The `channel` can be one `LED_CHANNEL_0` → `LED_CHANNEL_7`.

Includes:

- `#include <driver/ledc.h>`

## ledc\_channel\_config

Configure a PWM channel.

```
esp_err_t ledc_channel_config(  
    ledc_channel_config_t* ledcConf)
```

The `ledcConf` structure contains:

- `gpio_num` – The GPIO pin upon which the signal will appear.
- `speed_mode` – One of:
  - `LEDC_HIGH_SPEED_MODE`
- `channel` – One of:
  - `LEDC_CHANNEL0` → `LEDC_CHANNEL7`
- `intr_type` – One of:
  - `LEDC_INTR_DISABLE`
  - `LEDC_INTR_FADE_END`
- `timer_sel` – One of:
  - `LEDC_TIMER0` → `LEDC_TIMER_3`
- `duty` – Duty range. The duration of the high signal within any given period. The value is specified as the value of the timer after which the signal will drop low. Note that the granularity of a timer is specified when the timer is configured and can be between 10 and 15 bits. The "speed" of increments is defined by the frequency property of the timer.

Includes:

- `#include <driver/ledc.h>`

See also:

- `ledc_timer_config`

## ledc\_fade\_func\_install

```
esp_err_t ledc_fade_func_install(int intr_alloc_flags)
```

Includes:

- `#include <driver/ledc.h>`



## ledc\_fade\_start

```
esp_err_t ledc_fade_start(  
    ledc_channel_t channel,  
    ledc_fade_mode_t wait_done)
```

Includes:

- `#include <driver/ledc.h>`

## ledc\_fade\_func\_uninstall

```
void ledc_fade_func_uninstall()
```

Includes:

- `#include <driver/ledc.h>`

## ledc\_get\_duty

Get the duty value for the channel.

```
int ledc_get_duty(  
    ledc_mode_t speedMode,  
    ledc_channel_t channel)
```

Currently, `speedMode` can only be `LEDC_HIGH_SPEED_MODE`.

The `channel` can be one `LED_CHANNEL_0` → `LED_CHANNEL_7`.

Includes:

- `#include <driver/ledc.h>`

See also:

- `ledc_set_duty`
- `ledc_channel_config`
- `ledc_update_duty`

## ledc\_get\_freq

Get the frequency for the timer.

```
uint32_t ledc_get_freq(  
    ledc_mode_t speedMode,  
    ledc_timer_t timerNum)
```

Currently, `speedMode` can only be `LEDC_HIGH_SPEED_MODE`.

The `timerNum` can be one of:

- LEDC\_TIMER\_0
- LEDC\_TIMER\_1
- LEDC\_TIMER\_2
- LEDC\_TIMER\_3

Includes:

- `#include <driver/ledc.h>`

### ledc\_set\_duty

Set the duty value for the channel.

```
esp_err_t ledc_set_duty(
    ledc_mode_t    speedMode,
    ledc_channel_t channel,
    uint32_t       duty)
```

Currently, `speedMode` can only be `LEDC_HIGH_SPEED_MODE`.

The `channel` can be one `LED_CHANNEL_0` → `LED_CHANNEL_7`.

The `duty` value is set as a function of the number of bits set for the channel.

Includes:

- `#include <driver/ledc.h>`

See also:

- `ledc_update_duty`
- `ledc_channel_config`
- `ledc_get_duty`

### ledc\_isr\_register

Register an ISR.

```
esp_err_t ledc_isr_register(
    uint32_t ledc_intr_num,
    void (*fn)(void *), void *arg)
```

Includes:

- `#include <driver/ledc.h>`

## ledc\_set\_fade

Set the fade value.

```
esp_err_t ledc_set_fade(  
    ledc_mode_t      speedMode,  
    uint32_t         channel,  
    uint32_t         duty,  
    ledc_duty_duration_t graduleDirection,  
    uint32_t         stepNum,  
    uint32_t         dutyCycleNum,  
    uint32_t         dutyScale)
```

Currently, `speedMode` can only be `LEDC_HIGH_SPEED_MODE`.

The `channel` is the channel against which we are setting the fading.

The `duty` is the start value of the duty against which we will then fade.

The `graduleDuration` is the direction of the fade. It may be one of:

- `LEDC_DUTY_DIR_INCREASE` – Increase the duty value over time.
- `LEDC_DUTY_DIR_DECREASE` – Decrease the duty value over time.

The `dutyScale` is the amount that the duty value is changed each cycle.

The `dutyCycleNum` is the number of clock cycles that pass before the duty value of the channel is changed by the `dutyScale` amount.

The `stepNum` is the count of the number of times the duty value will change before the fade cycle is considered complete.

Includes:

- `#include <driver/ledc.h>`

## ledc\_set\_fade\_with\_step

```
esp_err_t ledc_set_fade_with_step(  
    ledc_mode_t      speed_mode,  
    ledc_channel_t   channel,  
    int              target_duty,  
    int              scale,  
    int              cycle_num)
```

Currently, `speedMode` can only be `LEDC_HIGH_SPEED_MODE`.

The `channel` can be one `LED_CHANNEL_0` → `LED_CHANNEL_7`.

Includes:

- `#include <driver/ledc.h>`

## ledc\_set\_fade\_with\_time

Fade from current value to target value.

```
esp_err_t ledc_set_fade_with_time(  
    ledc_mode_t    speed_mode,  
    ledc_channel_t channel,  
    int            target_duty,  
    int            max_fade_time_ms)
```

Currently, speedMode can only be LEDC\_HIGH\_SPEED\_MODE.

The channel can be one LED\_CHANNEL\_0 → LEDC\_CHANNEL\_7.

The target\_duty is the target duty value we want to reach relative to the current value.

The max\_fade\_time\_ms is the time it should take us to reach the duty value.

Includes:

- #include <driver/ledc.h>

## ledc\_set\_freq

Set the frequency for the timer.

```
esp_err_t ledc_set_freq(  
    ledc_mode_t    speedMode, // LEDC_HIGH_SPEED_MODE only  
    ledc_timer_t   timerNum,  
    uint32_t       freqHz)
```

Currently, speedMode can only be LEDC\_HIGH\_SPEED\_MODE.

The timerNum can be one of:

- LEDC\_TIMER\_0
- LEDC\_TIMER\_1
- LEDC\_TIMER\_2
- LEDC\_TIMER\_3

Includes:

- #include <driver/ledc.h>

## ledc\_stop

Halt the PWM signal output.

```
esp_err_t ledc_stop(  
    ledc_mode_t    speedMode,  
    ledc_channel_t channel,  
    uint32_t       idleLevel)
```

Currently, speedMode can only be LEDC\_HIGH\_SPEED\_MODE.

The channel can be one LED\_CHANNEL\_0 → LEDC\_CHANNEL\_7.

Includes:

- #include <driver/ledc.h>

### ledc\_timer\_config

Configure a PWM timer.

```
esp_err_t ledc_timer_config(  
    ledc_timer_config_t* timerConf)
```

The timerConf is a pointer to a structure containing:

- ledc\_mode\_t speed\_mode – Can be one of:
  - LEDC\_HIGH\_SPEED\_MODE
- ledc\_timer\_bit\_t duty\_resolution – Can be one of:
  - LEDC\_TIMER\_10\_BIT – 0-1023
  - LEDC\_TIMER\_11\_BIT – 0-2047
  - LEDC\_TIMER\_12\_BIT – 0-4095
  - LEDC\_TIMER\_13\_BIT – 0-8191
  - LEDC\_TIMER\_14\_BIT – 0-16383
  - LEDC\_TIMER\_15\_BIT – 0-32767
- ledc\_timer\_t timer\_num – Can be one of:
  - LEDC\_TIMER\_0
  - LEDC\_TIMER\_1
  - LEDC\_TIMER\_2
  - LEDC\_TIMER\_3
- uint32\_t freq\_hz – The frequency of the signal in Hz.

Includes:

- `#include <driver/ledc.h>`

See also:

- LEDC – Pulse Width Modulation – PWM
- `ledc_channel_config`

### **ledc\_timer\_pause**

Pause the timer.

```
esp_err_t ledc_timer_pause(  
    ledc_mode_t speedMode,  
    uint32_t timerSel)
```

Currently, `speedMode` can only be `LEDC_HIGH_SPEED_MODE`.

Includes:

- `#include <driver/ledc.h>`

### **ledc\_timer\_resume**

Resume the timer.

```
esp_err_t ledc_timer_resume(  
    ledc_mode_t speedMode,  
    uint32_t timerSel)
```

Currently, `speedMode` can only be `LEDC_HIGH_SPEED_MODE`.

Includes:

- `#include <driver/ledc.h>`

### **ledc\_timer\_rst**

Reset the timer.

```
esp_err_t ledc_timer_rst(  
    ledc_mode_t speedMode,  
    uint32_t timerSel)
```

Currently, `speedMode` can only be `LEDC_HIGH_SPEED_MODE`.

Includes:

- `#include <driver/ledc.h>`

## ledc\_timer\_set

Explicitly set the timer details.

```
esp_err_t ledc_timer_set(  
    ledc_mode_t    speedMode,  
    ledc_timer_t   timerSel,  
    uint32_t       divNum,  
    uint32_t       bitNum,  
    ledc_clk_src_t clkSrc)
```

Currently, `speedMode` can only be `LEDC_HIGH_SPEED_MODE` (value is 0).

The `timerSel` can be one of:

- `LEDC_TIMER_0`
- `LEDC_TIMER_1`
- `LEDC_TIMER_2`
- `LEDC_TIMER_3`

The `divNum` is ??.

The `bitNum` is ??.

The `clkSrc` is one of `LEDC_REF_TICK` (value is 0, 1MHz) or `LEDC_APB_CLK` (value is 1, 80Mhz).

Includes:

- `#include <driver/ledc.h>`

## ledc\_update\_duty

Update the duty value or the fade parameters for the channel.

```
esp_err_t ledc_update_duty(  
    ledc_mode_t speedMode,  
    ledc_channel_t channel)
```

Currently, `speedMode` can only be `LEDC_HIGH_SPEED_MODE`.

The `channel` can be one `LED_CHANNEL_0` → `LED_CHANNEL_7`.

Includes:

- `#include <driver/ledc.h>`

See also:

- `ledc_get_duty`
- `ledc_set_duty`

- ledc\_channel\_config

## Pulse Counter

When we think of a GPIO pin, we can imagine it as being able to change signal levels transitioning from 0 to 1 or 1 to 0. We will call such a transition a pulse. There are solutions where it is useful to count the pulses and perform some work as a result. Some examples may be:

- Stopping a winch when it has made some number of revolutions.
- Counting the number of folks entering or leaving a room.

We will now introduce the concept of a pulse counter unit (unit). We can think of this as a building block that has an input pin on which pulses can be counted. Within the unit there is a counter which is initially set to zero. As a pulse arrives, the unit automatically increments the counter. We can ask the unit for its current value and we can reset the counter back to zero.

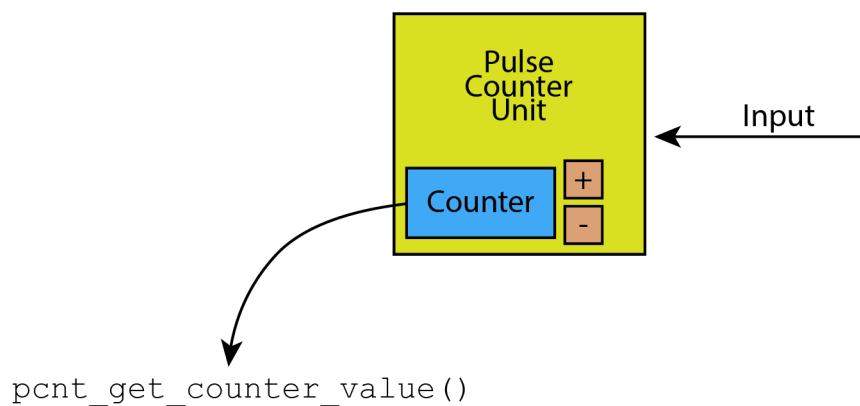

However, this is only the most basic functions; there is much more here than just that.

An immediate question is "what constitutes a pulse?". There are two possible answers to this ... either a transition from 0 to 1 (a positive edge transition) or a transition from 1 to 0 (a negative edge transition). When we configure our unit, we can define whether the counter changes on a positive or negative edge and, if so, in what direction the counter will change (increment or decrement). The choices for *each* edge are:

- Don't change the counter.
- Increment the counter.
- Decrement the counter.



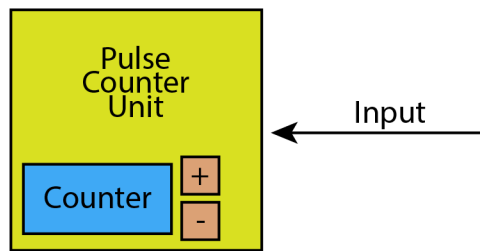

Rule	Positive	Negative
Increment	+1	+1
Decrement	-1	-1
Disable	=	=

Next we introduce the concept of a second pin called the *control pin*. While the data input pin is used to watch for pulses, the signal on the control pin is used to determine what should happen when a pulse is detected. Since the signal on any pin can be either 0 (low) or 1 (high) we have two possible states for the control pin. What this means is that we can instruct our unit on what to do when a pulse is detected on the input pin when the control pin is low and a different set of instructions on what to do when a pulse is detected on the input pin when the control pin is high.

The actions we can specify for a control pin instruction are:

- Keep
- Reverse
- Disable

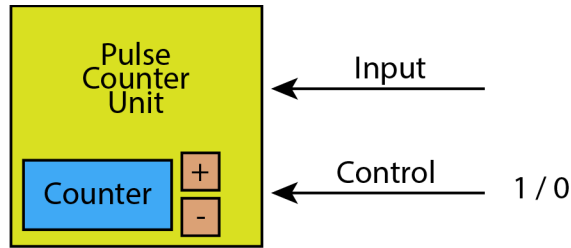

Rule	Control High	Control Low
Keep	Use data rule	Use data rule
Reverse	Invert data rule	Invert data rule
Disable	Ignore	Ignore

Hopefully you see that things are getting interesting. What this means is that we can (for example) say that when a pulse is detected when the control pin is low, we increment the counter while when a pulse is detected when the control pin is high, we decrement the counter.

As if this wasn't enough, the unit has two separate channels. Think of this as two pairs of input and control pins both associated with the same counter. This allows us to have a pulse on one pin that could be used to increment the counter while a pulse on a separate pin decrements the same counter.

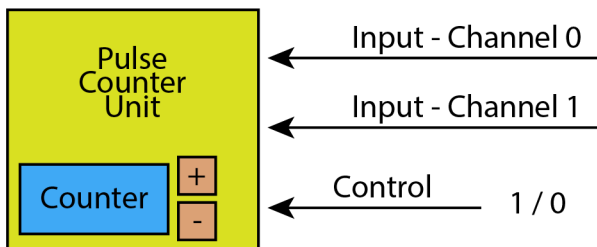

In the ESP32, there isn't just one pulse counter unit, there are eight separate units with all the functions just described. However since they are all identical in function, we will continue to describe our story as though there were just a single unit.

The value of the counter is a signed 16bit value. This means it can range from -32767 to 32767.

Once the unit is configured, it will perform its duties autonomously. Without further intervention it will happily increment and decrement the counter based on what it seems in the pulse inputs. What we may wish to happen next is that when some value is reached, we may wish to be explicitly told. We don't want to poll the counter as we may

wish to know instantly when a value is reached. We can register an interrupt handler that can be called when certain values are reached.

When we think of an arriving signal on the data input we should consider that to be a signal level transition. That transition may cause the counter to change. Unfortunately in real-world electronics, there may be spurious noise on the pins that may inadvertently cause a false indication of a transition. To solve that problem, we have the idea of a signal filter. What this means is that for a transition to be counter as a pulse, that transition must remain stable for a specified interval of time. For example, if a signal transitions from high to low and back again to high within the space of 10nano seconds, we may wish to consider that a glitch and ignore it from a counter perspective. Effectively, it is as though the pulse never happened. We can specify a filter interval value for each input.

Since there so many states here, another way to tell the story would be to look at from the perspective of pseudo code that implements the algorithm.

```
onSignalChange(transition) {
    if (transition == High) {
        if (posMode == INC) {
            dir = 1;
        } else if (posMode == DEC) {
            dir = -1;
        } else {
            return;
        }
    } else {
        if (negMode == INC) {
            dir = 1;
        } else if (negMode == DEC) {
            dir = -1;
        } else {
            return;
        }
    }
}
if (ioCtrl == HIGH) {
    if (hCtrl_Mode == DISABLE) {
        return;
    } else if (hCtrl_Mode == REVERSE) {
        dir = -dir;
    }
} else {
    if (lCtrl_Mode == DISABLE) {
        return;
    } else if (lCtrl_Mode == REVERSE) {
        dir = -dir;
    }
}
```

```
    counterValue = counterVaue + dir;
}
```

The API for the pulse counter units is rich. Here is a quick summary:

- `pcnt_get_counter_value()` - Get the current counter value.
- `pcnt_counter_clear()` - Set the counter value to zero.
- `pcnt_counter_pause()` - Pause processing of pulses.
- `pcnt_counter_resume()` - Resume processing of pulses.
- `pcnt_unit_config()` - Configure the unit.
- `pcnt_set_mode()` - Configure the mode of the unit.
- `pcnt_set_pin()` - Set the pins for the unit.
- `pcnt_set_filter_value()` - Set the filter value.
- `pcnt_get_filter_value()` - Get the filter value.
- `pcnt_filter_enable()` - Enable filtering of the input pin data.
- `pcnt_filter_disable()` - Disable filtering of the input pin data.

See also:

- [ESP32 Docs: Pulse Counter](#)
- Chapter 17 of the ESP32 Technical Reference Manual – PULSE\_CNT

### **pcnt\_counter\_clear**

Clear and reset the counter to zero.

```
esp_err_t pcnt_counter_clear(pcnt_unit_t pcnt_unit)
```

There are 8 units identified as `PCNT_UNIT_0` to `PCNT_UNIT_7`.

### **pcnt\_counter\_pause**

Pause processing of the pulse counter unit.

```
esp_err_t pcnt_counter_pause(pcnt_unit_t pcnt_unit)
```

Suspend changing the counters as new pulses arrive.

There are 8 units identified as `PCNT_UNIT_0` to `PCNT_UNIT_7`.

See also:

- `pcnt_counter_resume`

### **pcnt\_counter\_resume**

Resume processing of the pulse counter unit.

```
esp_err_t pcnt_counter_resume(pcnt_unit_t pcnt_unit)
```

Resume changing the counters as new pulses arrive.

There are 8 units identified as `PCNT_UNIT_0` to `PCNT_UNIT_7`.

See also:

- `pcnt_counter_pause`

### **pcnt\_event\_disable**

```
esp_err_t pcnt_event_disable(  
    pcnt_unit_t    unit,  
    pcnt_evt_type_t evt_type)
```

There are 8 units identified as `PCNT_UNIT_0` to `PCNT_UNIT_7`.

The event types are:

- `PCNT_EVT_L` – Minimum counter value reached, counter is reset.
- `PCNT_EVT_H` – Maximum counter value reached, counter is reset.
- `PCNT_EVT_THRES_0` – Specific value reached, counter is not reset.
- `PCNT_EVT_THRES_1` – Specific value reached, counter is not reset.
- `PCNT_EVT_ZERO` – Counter value at 0.

See also:

- `pcnt_event_enable`

### **pcnt\_event\_enable**

```
esp_err_t pcnt_event_enable(  
    pcnt_unit_t    unit,  
    pcnt_evt_type_t evt_type)
```

There are 8 units identified as `PCNT_UNIT_0` to `PCNT_UNIT_7`.

The event types are:

- `PCNT_EVT_L` – Minimum counter value reached, counter is reset.
- `PCNT_EVT_H` – Maximum counter value reached, counter is reset.
- `PCNT_EVT_THRES_0` – Specific value reached, counter is not reset.

- PCNT\_EVT\_THRES\_1 – Specific value reached, counter is not reset.
- PCNT\_EVT\_ZERO – Counter value at 0.

See also:

- pcnt\_event\_disable

### pcnt\_filter\_enable

Enable the input filter.

```
esp_err_t pcnt_filter_enable(pcnt_unit_t unit)
```

There are 8 units identified as PCNT\_UNIT\_0 to PCNT\_UNIT\_7.

See also:

- pcnt\_filter\_disable
- pcnt\_set\_filter\_value

### pcnt\_filter\_disable

Disable the input filter.

```
esp_err_t pcnt_filter_disable(pcnt_unit_t unit)
```

There are 8 units identified as PCNT\_UNIT\_0 to PCNT\_UNIT\_7.

See also:

- pcnt\_filter\_enable
- pcnt\_set\_filter\_value

### pcnt\_get\_counter\_value

Get the value of the pulse counter unit.

```
esp_err_t pcnt_get_counter_value(
    pcnt_unit_t pcnt_unit,
    int16_t* count)
```

There are 8 units identified as PCNT\_UNIT\_0 to PCNT\_UNIT\_7.

### pcnt\_get\_event\_value

Get the current event value for the given event type for the unit.

```
esp_err_t pcnt_get_event_value(
    pcnt_unit_t unit,
    pcnt_evt_type_t evt_type,
    int16_t* value)
```

There are 8 units identified as `PCNT_UNIT_0` to `PCNT_UNIT_7`.

The `value` is a pointer to a 16bit sized piece of storage that will hold the event value.

The event types are:

- `PCNT_EVT_L` – Minimum counter value reached, counter is reset.
- `PCNT_EVT_H` – Maximum counter value reached, counter is reset.
- `PCNT_EVT_THRES_0` – Specific value reached, counter is not reset.
- `PCNT_EVT_THRES_1` – Specific value reached, counter is not reset.
- `PCNT_EVT_ZERO` – Counter value at 0.

See also:

- `pcnt_set_event_value`
- `pcnt_event_disable`
- `pcnt_event_enable`

### `pcnt_get_filter_value`

Get the filter duration value.

```
esp_err_t pcnt_get_filter_value(  
    pcnt_unit_t unit,  
    uint16_t* filter_val)
```

If filtering is enabled, pulses lasting less than this duration will be ignored. The filter value is a 10bit numeric meaning that its maximum value is 1023. The unit of time for the filter is `APB_CLK` cycles.

There are 8 units identified as `PCNT_UNIT_0` to `PCNT_UNIT_7`.

See also:

- `pcnt_set_filter_value`
- `pcnt_filter_enable`
- `pcnt_filter_disable`

### `pcnt_intr_enable`

Enable the interrupts for the pulse counter unit.

```
esp_err_t pcnt_intr_enable(pcnt_unit_t pcnt_unit)
```

There are 8 units identified as `PCNT_UNIT_0` to `PCNT_UNIT_7`.

See also:

- `pcnt_intr_disable`

- `pcnt_event_enable`
- `pcnt_event_disable`

### **pcnt\_intr\_disable**

Disable the interrupts for the pulse counter unit.

```
esp_err_t pcnt_intr_disable(pcnt_unit_t pcnt_unit)
```

There are 8 units identified as `PCNT_UNIT_0` to `PCNT_UNIT_7`.

See also:

- `pcnt_intr_enable`
- `pcnt_event_enable`
- `pcnt_event_disable`

### **pcnt\_isr\_handler\_add**

Add an ISR handler for the given unit.

```
esp_err_t pcnt_isr_handler_add(
    pcnt_unit_t unit,
    void (*isr_handler)(void *),
    void *args)
```

There are 8 units identified as `PCNT_UNIT_0` to `PCNT_UNIT_7`.

See also:

- `pcnt_isr_handler_remove`
- `pcnt_isr_service_install`

### **pcnt\_isr\_handler\_remove**

```
esp_err_t pcnt_isr_handler_remove(pcnt_unit_t unit)
```

There are 8 units identified as `PCNT_UNIT_0` to `PCNT_UNIT_7`.

See also:

- `pcnt_isr_handler_add`
- `pcnt_isr_service_install`

### **pcnt\_isr\_register**

Register an ISR for interrupt handling.

```
esp_err_t pcnt_isr_register(
    void (*fn)(void*),
    void* arg,
    int intr_alloc_flags,
    pcnt_isr_handle_t* handle)
```



Do **not** use this function in conjunction with `pcnt_isr_service_install()`.

See also:

- `pcnt_isr_service_install`

### **pcnt\_isr\_service\_install**

```
esp_err_t pcnt_isr_service_install(int intr_alloc_flags)
```

Do **not** use this function in conjunction with `pcnt_isr_register()`.

See also:

- `pcnt_isr_service_uninstall`
- `pcnt_isr_register`
- `pcnt_isr_handler_add`
- `pcnt_isr_handler_remove`

### **pcnt\_isr\_service\_uninstall**

```
void pcnt_isr_service_uninstall(void)
```

See also:

- `pcnt_isr_service_install`

### **pcnt\_set\_event\_value**

Set the value for the given event type for the unit.

```
esp_err_t pcnt_set_event_value(  
    pcnt_unit_t      unit,  
    pcnt_evt_type_t evt_type,  
    int16_t          value)
```

There are 8 units identified as `PCNT_UNIT_0` to `PCNT_UNIT_7`.

The event types are:

- `PCNT_EVT_L` – Minimum counter value reached, counter is reset.
- `PCNT_EVT_H` – Maximum counter value reached, counter is reset.
- `PCNT_EVT_THRES_0` – Specific value reached, counter is not reset.
- `PCNT_EVT_THRES_1` – Specific value reached, counter is not reset.
- `PCNT_EVT_ZERO` – Counter value at 0.

The high limit and low limit can also be set through `pcnt_unit_config()`.

See also:

- `pcnt_get_event_value`
- `pcnt_event_disable`
- `pcnt_event_enable`

## `pcnt_set_filter_value`

Set the duration for filtering.

```
esp_err_t pcnt_set_filter_value(  
    pcnt_unit_t unit,  
    uint16_t filter_val)
```

There are 8 units identified as `PCNT_UNIT_0` to `PCNT_UNIT_7`.

If filtering is enabled, pulses lasting less than this duration will be ignored. The filter value is a 10bit numeric meaning that its maximum value is 1023. The unit of time for the filter is `APB_CLK` cycles with runs at 80MHz. This means that the maximum filter can be about 12.8uS.

- `pcnt_filter_enable`
- `pcnt_filter_disable`
- `pcnt_get_filter_value`

## `pcnt_set_mode`

Set the counter mode of operation.

```
esp_err_t pcnt_set_mode(  
    pcnt_unit_t unit,  
    pcnt_channel_t channel,  
    pcnt_count_mode_t pos_mode,  
    pcnt_count_mode_t neg_mode,  
    pcnt_ctrl_mode_t hctrl_mode,  
    pcnt_ctrl_mode_t lctrl_mode)
```

There are 8 units identified as `PCNT_UNIT_0` to `PCNT_UNIT_7`.

The `channel` is one of `PCNT_CHANNEL_0` or `PCNT_CHANNEL_1`.

The `pos_mode` is what should happen when the input signal transitions from low to high (a positive edge) while `neg_mode` is what should happen when the input signal transitions from high to low (a negative edge).

Both `pos_mode` and `neg_mode` can be one of:

- `PCNT_COUNT_DIS` – Don't change the counter value (disable change).
- `PCNT_COUNT_INC` – Increment the counter value.
- `PCNT_COUNT_DEC` – Decrement the counter value.

The `hctrl_mode` is what should happen when the control value on the control pin is high.

The `lctrl_mode` is what should happen when the control value on the control pin is low.

Both `hctrl_mode` and `lctrl_mode` can be one of:

- `PCNT_MODE_KEEP` – Perform the `pos_mode/neg_mode` rules.
- `PCNT_MODE_REVERSE` – Invert the `pos_mode/neg_mode` rules.
- `PCNT_MODE_DISABLE` – Don't change the counter value.

See also:

- `pcnt_unit_config`

## `pcnt_set_pin`

Set the input and control pins for the unit.

```
esp_err_t pcnt_set_pin(  
    pcnt_unit_t    unit,  
    pcnt_channel_t channel,  
    int            pulse_io,  
    int            ctrl_io)
```

There are 8 units identified as `PCNT_UNIT_0` to `PCNT_UNIT_7`.

The `channel` is one of `PCNT_CHANNEL_0` or `PCNT_CHANNEL_1`.

We can specify the pin value of `PCNT_PIN_NOT_USED` to disable the use of a pin.

See also:

- `pcnt_unit_config`

## `pcnt_unit_config`

Configure a pulse counter unit.

```
esp_err_t pcnt_unit_config(pcnt_config_t* pcnt_config)
```

The `pcnt_config_t` data structure contains:

- `int pulse_gpio_num` – The pin to use for data. Can be supplied as `PCNT_PIN_NOT_USED`.
- `int ctrl_gpio_num` – The pin to use for control. Can be supplied as `PCNT_PIN_NOT_USED`.
- `pcnt_ctrl_mode_t lctrl_mode` – Rules to perform when control pin is low.

- PCNT\_MODE\_KEEP – Perform the rules for `pos_mode` / `neg_mode`.
- PCNT\_MODE\_REVERSE – Invert the rules for `pos_mode` / `neg_mode`.
- PCNT\_MODE\_DISABLE – Don't change the counter.
- `pcnt_ctrl_mode_t hctrl_mode` – Rules to perform when control pin is high.
  - PCNT\_MODE\_KEEP – Perform the rules for `pos_mode` / `neg_mode`.
  - PCNT\_MODE\_REVERSE – Invert the rules for `pos_mode` / `neg_mode`.
  - PCNT\_MODE\_DISABLE – Don't change the counter.
- `pcnt_count_mode_t pos_mode` – Rule to perform on positive edge.
  - PCNT\_COUNT\_DIS – Don't change the counter (disable change).
  - PCNT\_COUNT\_INC – Increment the counter.
  - PCNT\_COUNT\_DEC – Decrement the counter.
- `pcnt_count_mode_t neg_mode` – Rule to perform on negative edge.
  - PCNT\_COUNT\_DIS – Don't change the counter (disable change).
  - PCNT\_COUNT\_INC – Increment the counter.
  - PCNT\_COUNT\_DEC – Decrement the counter.
- `int16_t counter_h_lim` – High counter limit.
- `int16_t counter_l_lim` – Low counter limit.
- `pcnt_unitI_t unit` – Identity of one of the 8 units.
  - PCNT\_UNIT\_0
  - ...
  - PCNT\_UNIT\_7
- `pcnt_channel_t channel`
  - PCNT\_CHANNEL\_0 – Settings for channel 0.
  - PCNT\_CHANNEL\_1 – Settings for channel 1.

See also:

- `pcnt_set_pin`
- `pcnt_set_mode`

## Logging

ESP-IDF provides a set of logging functions primarily used for debugging. The primary include file is called "esp\_log.h".

### esp\_err\_to\_name

Convert an error code to a string representation.

```
char* esp_err_to_name(esp_err_t code)
```

Includes:

- #include <esp\_err.h>

### esp\_err\_to\_name\_r

Convert an error code to a string representation.

```
char *esp_err_to_name_r(esp_err_tcode, char *buf, size_t buflen)
```

Includes:

- #include <esp\_err.h>

### esp\_log\_level\_set

Set the log level for the specified tag.

```
void esp_log_level_set(  
    const char* tag,  
    esp_log_level_t level)
```

The tag is the identifier for the class of logging. The value "\*" resets all tags to the specified log level.

The level is the level of logging at or above that will be included in the log output. It may be one of:

- ESP\_LOG\_VERBOSE (5) – Log at the verbose level.
- ESP\_LOG\_DEBUG (4) – Log at the debug level.
- ESP\_LOG\_INFO (3) – Log at the information level.
- ESP\_LOG\_WARN (2) – Log at the warning level.
- ESP\_LOG\_ERROR (1) – Log at the error level.
- ESP\_LOG\_NONE (0) – No logging.

Invoking `esp_log_level_set("*", ESP_LOG_ERROR)`, disables all messages except errors.

Includes:

- `#include <esp_log.h>`

See also:

- ESP-IDF logging

### `esp_log_set_vprintf`

Specify a function that will be used to output the log data.

```
void esp_log_set_vprintf(vprintf_like_t func)
```

By default, the output of logging is sent to the UART but we may wish to perform other tasks such as a circular log in memory or writing to a storage device or sending over a TCP/IP socket. By providing our own function here, we can control the output destination and event tinker with the format (if needed).

The default function is `"&vprintf"`.

Includes:

- `#include <esp_log.h>`

See also:

- ESP-IDF logging

### `esp_log_write`

Write an entry to the output log.

```
void esp_log_write(  
    esp_log_level_t level,  
    const char *tag,  
    const char *format, ...)
```

The `level` is the level of this log record being written. It may be one of:

- `ESP_LOG_VERBOSE` – Log at the verbose level.
- `ESP_LOG_DEBUG` – Log at the debug level.
- `ESP_LOG_INFO` – Log at the information level.
- `ESP_LOG_WARN` – Log at the warning level.
- `ESP_LOG_ERROR` – Log at the error level.
- `ESP_LOG_NONE` – No logging.

The `tag` is the identifier for this tag of log and `format` is the specification of what is to be written. Ideally we shouldn't call this function directly but instead use of the logging macros such as `ESP_LOGV(tag, format, ...)`.

Includes:

- `#include <esp_log.h>`

See also:

- ESP-IDF logging

## Non Volatile Storage

The non-volatile storage components save and load data from storage that is preserved between boots.

See also:

- Non Volatile Storage

### `nvs_close`

Close a previously opened handle.

```
void nvs_close(nvs_handle handle)
```

Close a handle that was previously opened by a call to `nvs_open()`. Remember that updates to the store are not completed until after a call to `nvs_commit()`. Closing a handle without performing a commit will discard any changes.

Includes:

- `#include <nvs.h>`

See also:

- `nvs_open`

### `nvs_commit`

Commit changes to non volatile storage.

```
esp_err_t nvs_commit(nvs_handle handle)
```

Any writes made against the storage are committed at this point. Note that writes may have been committed before this point but this forces all the writes to be flushed. Think of this as committing any pending writes as opposed to anything related to a transaction.

Includes:

- `#include <nvs.h>`

### **nvs\_erase\_all**

Erase all the name value pairs.

```
esp_err_t nvs_erase_all(nvs_handle handle)
```

Erase all the name value pairs. Note that this may not be truly performed until after a call to `nvs_commit()`.

Includes:

- `#include <nvs.h>`

See also:

- `nvs_commit`

### **nvs\_erase\_key**

Erase a specific name/value key pair.

```
esp_err_t nvs_erase_key(  
    nvs_handle handle,  
    char *key)
```

Erase the name/value pair with the given key. The deletion may not truly occur until after an associated commit is made.

Includes:

- `#include <nvs.h>`

See also:

- `nvs_commit`

### **nvs\_flash\_init**

Initialize NVS with defaults.

```
esp_err_t nvs_flash_init(void)
```

The defaults as of 2016-10 are a 12KByte area starting at `0x0000 6000` in flash offset. This is `0x0000 6000` to `0x0000 8FFF` (by offsets).

Includes:

- `#include <nvs_flash.h>`



## **nvs\_flash\_init\_custom**

Custom initialize NVS.

```
esp_err_t nvs_flash_init_custom(  
    uint32_t baseSector,  
    uint32_t sectorCount)
```

Includes:

- `#include <nvs_flash.h>`

## **nvs\_get\_blob**

Retrieve a blob of data from storage.

```
esp_err_t nvs_get_blob(  
    nvs_handle handle,  
    const char* key,  
    void* out,  
    size_t* length)
```

The `out` is a pointer to the storage that will be used to hold the retrieved data. On input `length` holds the size of the storage available to hold the result and will be updated with the actual `length` retrieved.

If `out` has a NULL value then the `length` that is needed to be allocated to hold the data is returned in `length`.

The return value is `ESP_OK` on success and an indication code on error. Common codes include:

- `ESP_ERR_NVS_NOT_FOUND` – Key not found.

Includes:

- `#include <nvs.h>`

## **nvs\_get\_str**

Retrieve a null terminated string from storage.

```
esp_err_t nvs_get_str(  
    nvs_handle handle,  
    const char* key,  
    char* out,  
    size_t* length)
```

The `out` is a pointer to the storage that will be used to hold the retrieved data. On input `length` holds the size of the storage available to hold the result and will be updated with the actual `length` retrieved.

If `out` has a NULL value then the length that is needed to be allocated to hold the data is returned in `length`. This includes the NULL byte terminator.

The return value is `ESP_OK` on success and an indication code on error. Common codes include:

- `ESP_ERR_NVS_NOT_FOUND` – Key not found.

Includes:

- `#include <nvs.h>`

### **`nvs_get_i8`**

Retrieve an 8 bit integer.

```
esp_err_t nvs_get_i8(  
    nvs_handle handle,  
    const char* key,  
    int8_t* out_value)
```

The return value is `ESP_OK` on success and an indication code on error. Common codes include:

- `ESP_ERR_NVS_NOT_FOUND` – Key not found.

Includes:

- `#include <nvs.h>`

### **`nvs_get_i16`**

Retrieve a 16 bit integer.

```
esp_err_t nvs_get_i16(  
    nvs_handle handle,  
    const char* key,  
    int16_t* out_value)
```

The return value is `ESP_OK` on success and an indication code on error. Common codes include:

- `ESP_ERR_NVS_NOT_FOUND` – Key not found.

Includes:

- `#include <nvs.h>`

### **nvs\_get\_i32**

Retrieve a 32 bit integer.

```
esp_err_t nvs_get_i32(  
    nvs_handle handle,  
    const char* key,  
    int32_t* out_value)
```

The return value is ESP\_OK on success and an indication code on error. Common codes include:

- ESP\_ERR\_NVS\_NOT\_FOUND – Key not found.

Includes:

- #include <nvs.h>

### **nvs\_get\_i64**

Retrieve a 64 bit integer.

```
esp_err_t nvs_get_i64(  
    nvs_handle handle,  
    const char* key,  
    int64_t* out_value)
```

The return value is ESP\_OK on success and an indication code on error. Common codes include:

- ESP\_ERR\_NVS\_NOT\_FOUND – Key not found.

Includes:

- #include <nvs.h>

### **nvs\_get\_u8**

Retrieve an unsigned 8 bit integer.

```
esp_err_t nvs_get_u8(  
    nvs_handle handle,  
    const char* key,  
    uint8_t* out_value)
```

The return value is ESP\_OK on success and an indication code on error. Common codes include:

- ESP\_ERR\_NVS\_NOT\_FOUND – Key not found.

Includes:

- `#include <nvs.h>`

### **nvs\_get\_u16**

Retrieve an unsigned 16 bit integer.

```
esp_err_t nvs_get_u16(  
    nvs_handle handle,  
    const char* key,  
    uint16_t*   outValue)
```

The return value is `ESP_OK` on success and an indication code on error. Common codes include:

- `ESP_ERR_NVS_NOT_FOUND` – Key not found.

Includes:

- `#include <nvs.h>`

### **nvs\_get\_u32**

Retrieve an unsigned 32 bit integer.

```
esp_err_t nvs_get_u32(  
    nvs_handle handle,  
    const char* key,  
    uint32_t*   outValue)
```

The return value is `ESP_OK` on success and an indication code on error. Common codes include:

- `ESP_ERR_NVS_NOT_FOUND` – Key not found.

Includes:

- `#include <nvs.h>`

### **nvs\_get\_u64**

Retrieve an unsigned 64 bit integer.

```
esp_err_t nvs_get_u64(  
    nvs_handle handle,  
    const char* key,  
    uint64_t*   outValue)
```

The return value is `ESP_OK` on success and an indication code on error. Common codes include:

- `ESP_ERR_NVS_NOT_FOUND` – Key not found.

Includes:

- `#include <nvs.h>`

## `nvs_open`

Open a storage area with a given namespace.

```
esp_err_t nvs_open(  
    const char*   name,  
    nvs_open_mode open_mode,  
    nvs_handle*   outHandle)
```

Open a given named storage area for access. The name of the area is supplied in the `name` parameter. The `open_mode` may be one of:

- `NVS_READWRITE` – The application can read and write the storage.
- `NVS_READONLY` – The application can only read the storage.

The `outHandle` is a pointer to storage where a handle will be stored. This is the handle passed into other NVS API calls.

If the call succeeded, `ESP_OK` will be returned. Otherwise other codes such as:

- `ESP_ERR_NVS_NOT_FOUND` – Namespace doesn't exist and opened read-only.

For example:

```
nvs_handle handle;  
nvs_open("namespace", NVS_READWRITE, &handle);  
...  
nvs_close(handle);
```

Includes:

- `#include <nvs.h>`

See also:

- `nvs_close`

## `nvs_set_blob`

Save a blob of data to storage. The maximum size is 4000 bytes per blob.

```
esp_err_t nvs_set_blob(  
    nvs_handle handle,  
    const char* key,
```

```
const void* value,  
size_t      length)
```

Includes:

- `#include <nvs.h>`

See also:

- `nvs_commit`

### **nvs\_set\_str**

Save a null terminated string.

```
esp_err_t nvs_set_str(  
    nvs_handle handle,  
    const char* key,  
    const char* value)
```

The `key` is the key against which the string will be saved.

The `value` is the value to save.

Includes:

- `#include <nvs.h>`

See also:

- `nvs_commit`

### **nvs\_set\_i8**

Save an 8 bit integer.

```
esp_err_t nvs_set_i8(  
    nvs_handle handle,  
    const char* key,  
    int8_t     value)
```

Includes:

- `#include <nvs.h>`

See also:

- `nvs_commit`

### **nvs\_set\_i16**

Save a 16 bit integer.

```
esp_err_t nvs_set_i16(  
    nvs_handle handle,
```

```
const char* key,  
int16_t     value)
```

Includes:

- `#include <nvs.h>`

See also:

- `nvs_commit`

### **nvs\_set\_i32**

Save a 32 bit integer.

```
esp_err_t nvs_set_i32(  
    nvs_handle handle,  
    const char* key,  
    int32_t     value)
```

Includes:

- `#include <nvs.h>`

See also:

- `nvs_commit`

### **nvs\_set\_i64**

Save a 64 bit integer.

```
esp_err_t nvs_set_i64(  
    nvs_handle handle,  
    const char* key,  
    int64_t     value)
```

See also:

- `nvs_commit`

### **nvs\_set\_u8**

Save an unsigned 8 bit integer.

```
esp_err_t nvs_set_u8(  
    nvs_handle handle,  
    const char* key,  
    uint8_t     value)
```

Includes:

- `#include <nvs.h>`

## See also:

- `nvs_commit`

## **nvs\_set\_u16**

Save an unsigned 16 bit integer.

```
esp_err_t nvs_set_u16(  
    nvs_handle handle,  
    const char* key,  
    uint16_t value)
```

## Includes:

- `#include <nvs.h>`

## See also:

- `nvs_commit`

## **nvs\_set\_u32**

Save an unsigned 32 bit integer.

```
esp_err_t nvs_set_u32(  
    nvs_handle handle,  
    const char* key,  
    uint32_t value)
```

## Includes:

- `#include <nvs.h>`

## See also:

- `nvs_commit`

## **nvs\_set\_u64**

Save an unsigned 64 bit integer.

```
esp_err_t nvs_set_u64(  
    nvs_handle handle,  
    const char* key,  
    uint64_t value)
```

## Includes:

- `#include <nvs.h>`

## See also:

- `nvs_commit`



## Partition API

One of the key data structures associated with this component is the `esp_partition_t`.

This contains the following:

- `esp_partition_type_t type` – The partition type.
- `esp_partition_subtype_t subtype` – The partition sub-type.
- `uint32_t address` – The address of the partition as an offset in flash.
- `uint32_t size` – The size of the partition in bytes.
- `char label[17]` – The label of the partition.
- `bool encrypted` – Is this partition encrypted.

We would typically call:

```
esp_partition_t* partition = esp_partition_find_first(Type, SubType, Label);
```

to find the partition we want. There is no need to release any resources after use.

From there, we can either read (copy) data into RAM using `esp_partition_read()` or map the data into the address space using `esp_partition_mmap()`.

See also:

- Partition table

### `esp_partition_erase_range`

Erase a range of data within a partition.

```
esp_err_t esp_partition_erase_range(  
    const esp_partition_t* partition,  
    uint32_t                start_addr,  
    uint32_t                size);
```

We must erase a partition before we can write to it.

Includes

- `#include <esp_partition.h>`

### `esp_partition_find`

Find a partition with a given type and optionally a subtype and/or label.

```
esp_partition_iterator_t esp_partition_find(  
    esp_partition_type_t    type,
```

```
esp_partition_subtype_t subtype,  
const char* label)
```

- `type` – The type of partition being sought. One of:
  - `ESP_PARTITION_TYPE_APP`
  - `ESP_PARTITION_TYPE_DATA`
- `subtype` – The sub type of the partition being sought. One of:
  - `ESP_PARTITION_SUBTYPE_APP_FACTORY`
  - `ESP_PARTITION_SUBTYPE_APP_OTA_XXX`
  - `ESP_PARTITION_SUBTYPE_APP_TEST`
  - `ESP_PARTITION_SUBTYPE_DATA_OTA`
  - `ESP_PARTITION_SUBTYPE_DATA_PHY`
  - `ESP_PARTITION_SUBTYPE_DATA_NVS`
  - `ESP_PARTITION_SUBTYPE_DATA_ESPHTTPD`
  - `ESP_PARTITION_SUBTYPE_DATA_FAT`
  - `ESP_PARTITION_SUBTYPE_DATA_SPIFFS`
  - `ESP_PARTITION_SUBTYPE_DATA_COREDUMP`
  - `ESP_PARTITION_SUBTYPE_ANY`
- `label` – The label of the partition being sought or NULL for don't care.

The return is an iterator that can be used to iterate over the found partitions. If no partitions were found that matched, then NULL is returned. The iterator must be released with `esp_partition_iterator_release()` when finished. To move to the next iterator call `esp_partition_next()`.

#### Includes

- `#include <esp_partition.h>`

#### See also:

- `esp_partition_get`
- `esp_partition_iterator_release`

#### `esp_partition_find_first`

Obtain the first partition that matches the details or NULL if none match.

```
const esp_partition_t* esp_partition_find_first(  
    esp_partition_type_t type,
```

```
esp_partition_subtype_t subtype,  
const char* label)
```

- `type` – The type of partition being sought. One of:
  - `ESP_PARTITION_TYPE_APP`
  - `ESP_PARTITION_TYPE_DATA`
- `subtype` – The sub type of the partition being sought. One of:
  - `ESP_PARTITION_SUBTYPE_APP_FACTORY`
  - `ESP_PARTITION_SUBTYPE_APP_OTA_xxx`
  - `ESP_PARTITION_SUBTYPE_APP_TEST`
  - `ESP_PARTITION_SUBTYPE_DATA_OTA`
  - `ESP_PARTITION_SUBTYPE_DATA_PHY`
  - `ESP_PARTITION_SUBTYPE_DATA_NVS`
  - `ESP_PARTITION_SUBTYPE_DATA_ESPHTTPD`
  - `ESP_PARTITION_SUBTYPE_DATA_FAT`
  - `ESP_PARTITION_SUBTYPE_DATA_SPIFFS`
  - `ESP_PARTITION_SUBTYPE_DATA_COREDUMP`
  - `ESP_PARTITION_SUBTYPE_ANY`
- `label` – The label of the partition being sought or NULL for don't care.

The return is an instance of the description of the partition. That is a data structure that contains:

- `type` – One of
  - `ESP_PARTITION_TYPE_APP`
  - `ESP_PARTITION_TYPE_DATA`
- `subtype` – One of:
  - `ESP_PARTITION_SUBTYPE_APP_FACTORY`
  - `ESP_PARTITION_SUBTYPE_APP_OTA_xxx`
  - `ESP_PARTITION_SUBTYPE_APP_TEST`
  - `ESP_PARTITION_SUBTYPE_DATA_OTA`

- ESP\_PARTITION\_SUBTYPE\_DATA\_PHY
- ESP\_PARTITION\_SUBTYPE\_DATA\_NVS
- ESP\_PARTITION\_SUBTYPE\_DATA\_ESPHTTPD
- ESP\_PARTITION\_SUBTYPE\_DATA\_FAT
- ESP\_PARTITION\_SUBTYPE\_DATA\_SPIFFS
- ESP\_PARTITION\_SUBTYPE\_DATA\_COREDUMP
- `address` – Starting address of the partition in flash.
- `size` – Size of the partition in bytes.
- `label` – NULL terminated string describing the partition.
- `encrypted` – True if the partition is encrypted.

#### Includes

- `#include <esp_partition.h>`

#### **esp\_partition\_get**

Get the partition details for the current iterator.

```
const esp_partition_t* esp_partition_get(esp_partition_iterator_t iterator)
```

The return is an instance of the description of the partition. That is a data structure that contains:

- `type` – One of
  - ESP\_PARTITION\_TYPE\_APP (0x00)
  - ESP\_PARTITION\_TYPE\_DATA (0x01)
- `subtype` – One of:
  - ESP\_PARTITION\_SUBTYPE\_APP\_FACTORY (0x00)
  - ESP\_PARTITION\_SUBTYPE\_APP\_OTA\_xxx (0x10 - 0x1F)
  - ESP\_PARTITION\_SUBTYPE\_APP\_TEST (0x20)
  - ESP\_PARTITION\_SUBTYPE\_DATA\_OTA (0x00)
  - ESP\_PARTITION\_SUBTYPE\_DATA\_PHY (0x01)
  - ESP\_PARTITION\_SUBTYPE\_DATA\_NVS (0x02)
  - ESP\_PARTITION\_SUBTYPE\_DATA\_COREDUMP (0x03)
  - ESP\_PARTITION\_SUBTYPE\_DATA\_ESPHTTPD (0x80)

- ESP\_PARTITION\_SUBTYPE\_DATA\_FAT (0x81)
- ESP\_PARTITION\_SUBTYPE\_DATA\_SPIFFS (0x82)
- `address` – Starting address of the partition in flash.
- `size` – Size of the partition in bytes.
- `label` – NULL terminated string describing the partition.
- `encrypted` – True if the partition is encrypted.

#### Includes

- `#include <esp_partition.h>`

#### See also:

- `esp_partition_find`

### **esp\_partition\_iterator\_release**

Release a previously constructed iterator.

```
void esp_partition_iterator_release(esp_partition_iterator_t iterator)
```

#### Includes

- `#include <esp_partition.h>`

#### See also:

- `esp_partition_find`

### **esp\_partition\_mmap**

Memory map the partition.

```
esp_err_t esp_partition_mmap(
    const esp_partition_t* pPartition,
    uint32_t offset,
    uint32_t size,
    spi_flash_mmap_memory_t memory,
    const void** out_ptr,
    spi_flash_mmap_handle_t* out_handle)
```

The goal is to map an area of a partition into memory address space so that it can be read without copying.

- `pPartition` – The identity of the partition to map.
- `offset` – The offset into the partition to map.

- `size` – How much of the partition should we map. This is typically `pPartition->size`.
- `memory` – Where the memory should be mapped. Choices are:
  - `SPI_FLASH_MMAP_DATA` – Map to data memory.
  - `SPI_FLASH_MMAP_INST` – Map to instruction memory.
- `out_ptr` – The address of a pointer where the partition data can be found.
- `out_handle` – The handle used to remember how this Flash memory was mapped. We can subsequently pass this into a call to `spi_flash_munmap()` to release.

To release the mapped partition data, we should call `spi_flash_munmap()` to release.

Includes

- `#include <esp_partition.h>`

See also:

- `spi_flash_munmap`

### `esp_partition_next`

Move the iterator to the next partition element.

```
esp_partition_iterator_t esp_partition_next(esp_partition_iterator_t iterator)
```

Includes

- `#include <esp_partition.h>`

See also:

- `esp_partition_find`
- `esp_partition_iterator_release`

### `esp_partition_read`

Read/copy data from the partition.

```
esp_err_t esp_partition_read(
    const esp_partition_t* partition,
    size_t                 src_offset,
    void*                  dst,
    size_t                 size)
```

- `partition` – The partition we wish to read from.
- `src_offset` – Where within the partition to start reading.

- `dst` – An area of memory into which to copy the data from the partition.
- `size` – How much memory to copy from the partition.

#### Includes

- `#include <esp_partition.h>`

### `esp_partition_write`

Write data to the partition.

**Important!!** - Before writing new data to the partition, it is *vital* that the partition first be erased with a call to `esp_partition_erase_range()`.

```
esp_err_t esp_partition_write(
    const esp_partition_t* partition,
    size_t                dst_offset,
    const void*           src,
    size_t                size)
```

#### Includes

- `#include <esp_partition.h>`

See also:

- `esp_partition_erase_range`

## Virtual File System

See also:

- [Virtual File System](#)

### `esp_vfs_dev_uart_register`

```
void esp_vfs_dev_uart_register()
```

Register the virtual file system known as `"/dev/uart"` as a serial port interface. We can thus access `"/dev/uart/0"`, `"/dev/uart/1"` and `"/dev/uart/2"`.

Functions support by **this** file system are:

- `open` –
- `close` –
- `write` –

- `fstat` –

If we attempt to read from a uart and there is no data, we get `EWOULDBLOCK` as a return code.

Includes:

- `#include <esp_vfs_dev.h>`

See also:

- Using the VFS component with serial

### **esp\_vfs\_dev\_uart\_set\_rx\_line\_endings**

```
void esp_vfs_dev_uart_set_rx_line_endings(esp_line_endings_t mode)
```

- `esp_line_endings_t mode` – The type of line ending.
  - `ESP_LINE_ENDINGS_CRLF`
  - `ESP_LINE_ENDINGS_CR`
  - `ESP_LINE_ENDINGS_LF`

### **esp\_vfs\_dev\_uart\_set\_tx\_line\_endings**

```
void esp_vfs_dev_uart_set_tx_line_endings(esp_line_endings_t mode)
```

- `esp_line_endings_t mode` – The type of line ending.
  - `ESP_LINE_ENDINGS_CRLF`
  - `ESP_LINE_ENDINGS_CR`
  - `ESP_LINE_ENDINGS_LF`

### **esp\_vfs\_dev\_uart\_use\_nonblocking**

Disables the previous setup of a driver.

```
void esp_vfs_dev_uart_use_nonblocking(int uart_num)
```

Reading from the UART becomes non-blocking. This is the default.

### **esp\_vfs\_dev\_uart\_use\_driver**

Use a UART driver for processing.

```
void esp_vfs_dev_uart_use_driver(int uart_num)
```



A UART driver is used for processing input. This provides blocking reads.

### **esp\_vfs\_spiffs\_register**

Register a SPIFFS file system as a Virtual File System.

```
esp_err_t esp_vfs_spiffs_register(esp_vfs_spiffs_conf_t* conf)
```

The `esp_vfs_spiffs_conf_t` contains:

- `const char* base_path` – File path prefix associated with the file system.
- `const char* partition_label` – The label of the partition that SPIFFS will use. If set to `NULL` the first partition with `subtype=spiffs` will be used.
- `size_t max_files` – Maximum number of files that can be open at one time.
- `bool format_if_mount_failed` – If true, format the file system if the mount fails.

Includes:

- `#include <esp_spiffs.h>`

### **esp\_vfs\_spiffs\_unregister**

Unregister a previously registered SPIFFS file system.

```
esp_err_t esp_vfs_spiffs_unregister(const char* partition_label)
```

- `partition_label` – The partition identifying the file system to unregister. If `NULL`, then the first partition with `subtype=spiffs` will be used.

Includes:

- `#include <esp_spiffs.h>`

See also:

### **esp\_vfs\_register**

Register a new VFS.

```
esp_err_t esp_vfs_register(  
    const char*     base_path,  
    const esp_vfs_t* vfs,  
    void*          ctx);
```

Register a new virtual file system. The `base_path` is a C string that can be no more than `ESP_VFS_PATH_MAX` characters in length (currently defined as 15). It must start with a "/" character and must not end with a "/". This will serve as the junction point for accessing data through this file system.

The `vfs` is a pointer to an `esp_vfs_t` that must be populated by the application making the call to `esp_vfs_register`. The data structure does not have to be maintained after making the call as a copy is made.

The `ctx` is a pointer to data that is passed to the registered functions if the `vfs` "flags" attribute is set to `ESP_VFS_FLAG_CONTEXT_PTR`. When used, all the callback functions have an additional option which is the context. The names of the functions change to have an "\_p" after them. For example, with the default setting, the close function signature is:

```
int close(int fd)
```

while when the context flag is set, the function signature changes to:

```
int close_p(void *ctx, int fd)
```

and the assignment property in the `esp_vfs_t` structure changes to the "\_p" versions.

Within the `esp_vfs_t` data structure we have the following fields:

- `fd_offset` – Offset value for numeric file descriptors.
- `flags` – Flags associated with this VFS. Choices today are:
  - `ESP_VFS_FLAG_DEFAULT` – Default value.
  - `ESP_VFS_FLAG_CONTEXT_PTR` – The context pointer functions are used and the context data is passed in.
- `write` – A function called to write data.

```
size_t (*write)(int fd, const void *data, size_t size)
```

Write into the file specified by the `fd` file descriptor the data pointed to by `data` of length `size` bytes. The return is the number of bytes actually written.

- `lseek` – A function called to seek within a file.

```
off_t (*lseek)(int fd, off_t offset, int whence)
```

The `whence` parameter is the controller of how offset is applied:

- `SEEK_SET` – Set the position to an absolute of offset.

- `SEEK_CUR` – Set the position relative to the current position plus offset. Offset can be negative to seek backwards.
- `SEEK_END` – Set the position relative to the end of the file plus offset. Offset can be used as 0 or negative.

- `read` – A function called to read data.

```
ssize_t (*read)(int fd, void *dst, size_t size)
```

- `open` – A function called to open a file.

```
int (*open)(const char *path, int flags, int accessMode)
```

The `path` is the path to the local file. The VFS prefix is removed and only the local file part is passed in. The `flags` are the operational flags as described in the Unix `open()` system call. The `accessMode` are the permission of the file when it is created.

- `close` – A function called to close a file.

```
int (*close)(int fd)
```

- `fstat` – A function called to stat a file by file descriptor.

```
int (*fstat)(int fd, struct stat *st)
```

- `stat` – A function called to stat a file by name.

```
int (*stat)(const char *path, struct stat *st)
```

The `struct stat` contains:

- `st_dev`
- `st_ino`
- `st_mode`
- `st_nlink`
- `st_uid`
- `st_gid`
- `st_rdev`

- `st_size`
- `st_blksize`
- `st_blocks`
- `st_atime`
- `st_mtime`
- `st_ctime`

- `link` – A function called to link a file.

```
int (*link)(const char *oldPath, const char *newPath)
```

The mapped POSIX api is: [man\(2\) – link](#)

- `unlink` – A function called to unlink a file.

```
int (*unlink)(const char *path)
```

The mapped POSIX api is: [man\(2\) – unlink](#)

- `rename` – A file called to rename a file.

```
int (*rename)(const char *oldPath, const char *newPath)
```

- `opendir` – Open a directory for reading.

```
DIR *opendir(const char *name)
```

- `readdir` – Read the next entry in the directory stream.

```
struct dirent readdir(DIR *pdir)
```

See also:

- [man\(3\) – readdir](#)

- `telldir` – Return the current location in the directory stream.

```
long telldir(DIR *pdir)
```

See also:

- [man\(3\) – telldir](#)

- `seekdir` – Set the position of the next `readdir()`.

```
void seekdir(DIR *pdir, long offset)
```

See also:

- [man\(3\) – seekdir](#)

- `closedir` – Close a directory.

```
int closedir(DIR *pdir)
```

See also:

- [man\(3\) – closedir](#)

- `mkdir` – Create a directory.

```
int mkdir(const char *name, mode_t mode)
```

See also:

- [man\(3\) – mkdir](#)

- `rmdir` – Delete a directory.

```
int rmdir(const char *name)
```

See also:

- [man\(2\) – rmdir](#)

Includes:

- `esp_vfs.h`

See also:

- [man\(2\) – open](#)
- [man\(2\) – close](#)
- [man\(3\) – closedir](#)
- [man\(2\) – fstat](#)
- [man\(2\) – link](#)
- [man\(3\) – mkdir](#)
- [man\(3\) – readdir](#)
- [man\(2\) – rename](#)
- [man\(2\) – rmdir](#)
- [man\(3\) – seekdir](#)
- [man\(2\) – stat](#)
- [man\(3\) – telldir](#)
- [man\(2\) – unlink](#)
- [man\(2\) – write](#)

## FatFs file system

See also:

- FATFS File System

### esp\_vfs\_fat\_register

```
esp_err_t esp_vfs_fat_register(
    const char *base_path,
    const char *fat_drive,
    size_t      max_files,
    FATFS      **out_fs)
```

The `base_path` is where the FAT file system should be registered.

The `fat_drive` is a FAT file system drive specification. If we only have one drive then this can be the empty string.

The `max_files` is the maximum number of files we can have open at one time.

The `out_fs` is a pointer to the FATFS structure used in the `f_mount()` call.

Includes:

- `#include <esp_vfs_fat.h>`

### esp\_vfs\_fat\_sdmmc\_mount

Mount an SD card as a posix file system.

```
esp_err_t esp_vfs_fat_sdmmc_mount(
    const char*                base_path,
    const sdmmc_host_t*        host_config,
    const sdmmc_slot_config_t* slot_config,
    const esp_vfs_fat_sdmmc_mount_config_t* mount_config,
    sdmmc_card_t**             out_card)
```

The `base_path` is the path in the POSIX file system which acts as the mount point for the files hosted in the FAT file system contained on the card. A common example is `"/sdcard"`.

The `host_config` is an instance of `sdmmc_host_t` and is commonly configured using `SDMMC_HOST_DEFAULT()`. For example:

```
sdmmc_host_t host_config = SDMMC_HOST_DEFAULT();
```

The `sdmmc_host_t` is a C structure that contains:

- `uint32_t flags` – Define operational flags. These include:
  - `SDMMC_HOST_FLAG_1BIT` – Host uses 1-line SD protocol.
  - `SDMMC_HOST_FLAG_4BIT` – Host uses 4-line SD protocol.
  - `SDMMC_HOST_FLAG_8BIT` – Host uses 8-line SD protocol.

- `SDMMC_HOST_FLAG_SPI` – Host uses SPI protocol.
- `int slot` – Unknown
- `int max_freq_khz` – Unknown
- `float io_voltage` – Unknown
- `init` – Function to be called to initialize the host layer.
- `set_bus_width` – Function to be called to set the bus width.
- `set_card_clk` – Function to be called to set the clock.
- `do_transaction` – Function to be called to perform a transaction.
- `deinit` – Function to be called to de-initialize the host layer.

Using the `SDMMC_HOST_DEFAULT()` to initialize the structure sets the following default values:

Property	Value
<code>flags</code>	<code>SDMMC_HOST_FLAG_4BIT</code>
<code>slot</code>	<code>SDMMC_HOST_SLOT_1</code>
<code>max_freq_khz</code>	<code>SDMMC_FREQ_DEFAULT</code>
<code>io_voltage</code>	3.3
<code>init</code>	<code>sdmmc_host_init</code>
<code>set_bus_width</code>	<code>sdmmc_host_set_bus_width</code>
<code>set_card_clk</code>	<code>sdmmc_host_set_card_clk</code>
<code>do_transaction</code>	<code>sdmmc_host_do_transaction</code>
<code>deinit</code>	<code>sdmmc_host_deinit</code>

The `slot_config` parameter is an instance of `sdmmc_slot_config_t` and is commonly configured using `SDMMC_SLOT_CONFIG_DEFAULT()`.

The `mount_config` parameter is an instance of `esp_vfs_far_sdmmc_mount_config_t` which has properties:

- `format_if_mount_failed`
- `max_files`

Includes:

- `#include <esp_vfs_fat.h>`

See also:

- `esp_vfs_fat_sdmmc_unmount`

## `esp_vfs_fat_sdmmc_unmount`

```
esp_err_t esp_vfs_fat_sdmmc_unmount()
```

Includes:

- `#include <esp_vfs_fat.h>`

See also:

- `esp_vfs_fat_sdmmc_mount`

## `esp_vfs_fat_spiflash_mount`

Initialize FAT file system in SPI flash and register with VFS.

```
esp_err_t esp_vfs_fat_spiflash_mount(
    const char*          base_path,
    const char*          partition_label,
    const esp_vfs_fat_mount_config_t* mount_config,
    wl_handle_t*         wl_handle)
```

This is a powerful convenience function that registers the FAT file system and associates it with the Virtual File System (VFS) subsystem this making it available for Posix based I/O APIs. It also integrates the Wear Leveling subsystem and is ideal for multiple writes.

- `base_path` – Path where FAT file system partition should be mounted (eg. `/spiflash`)
- `partition_label` – Label of the flash partition where the data will be stored.
- `mount_config` – Pointer to structure for parameters for mounting FAT file system.
- `wl_handle` – The returned/populated wear leveling driver handle.

The `mount_config` parameter points to a structure which provides control information for the mount operation. Specifically, it contains:

- `format_if_mount_failed` (`bool`) – A flag that indicates whether or not to format the SPI flash memory contained in the partition if the mount fails (presumably because the partition was not previously initialized).
- `max_files` (`int`) – The permitted maximum number of concurrently open files.
- `allocation_unit_size` (`size_t`) – The size of a sector. If set to 0, then we use the default sector size specified by the configuration property called `CONFIG_WL_SECTOR_SIZE`. This must be a power of 2. (ESP-IDF > v3.0).

An example of a partition record for a FAT file system held in SPI flash would be:



```
storage, data, fat, , 1M,
```

As of 2017-05, the smallest allowable size of the partition is 528K.

Note the type of the partition is "data" and the subtype is "fat".

An example partition file might be (partitions.csv):

```
nvs,      data, nvs,      0x9000, 0x6000,  
phy_init, data, phy,     0xf000, 0x1000,  
factory,  app,  factory, 0x10000, 1M,  
storage,  data, fat,     ,          1M,
```

If the partition area can not be found, we will get an error indication and if logging is enabled, see the following (or similar) message:

```
vfs_fat_spiflash: Failed to find FATFS partition (type='data', subtype='fat',  
partition_label='storage'). Check the partition table.
```

Example:

```
wl_handle_t wl_handle = WL_INVALID_HANDLE;  
esp_vfs_fat_mount_config_t mount_config;  
mount_config.max_files = 4;  
mount_config.format_if_mount_failed = true;  
  
esp_err_t err = esp_vfs_fat_spiflash_mount(  
    "/spiflash", "storage", &mount_config, &wl_handle);
```

Includes:

- `#include <esp_vfs_fat.h>`

See also:

- [Partition table](#)

### **esp\_vfs\_fat\_spiflash\_unmount**

Unmount the FAT file system and release the resources.

```
esp_err_t esp_vfs_fat_spiflash_unmount(  
    const char *base_path,  
    wl_handle_t wl_handle)
```

- `base_path` – The path where the FATFS file system was mounted.
- `wl_handle` – The handle returned from `esp_vfs_fat_spiflash_mount()`.

Includes:

- `#include <esp_vfs_fat.h>`

### **esp\_vfs\_fat\_unregister**

```
esp_err_t esp_vfs_fat_unregister()
```

This function has been deprecated in favor of `esp_vfs_fat_unregister_path()`. Don't use it for new code.

Includes:

- `#include <esp_vfs_fat.h>`

### **esp\_vfs\_fat\_unregister\_path**

Un-register the FATFS from VFS.

```
esp_err_t esp_vfs_fat_unregister_path(const char *base_path)
```

- `base_path` – The path prefix where FATFS was registered. This must be the same path as used in `esp_vfs_fat_register()`.

Includes:

- `#include <esp_vfs_fat.h>`
- 

### **f\_mount**

```
FRESULT f_mount(FATFS *fs, const char *path, BYTE opt)
```

The values of `opt` can be:

- 0 – Don't mount now.
- 1 – Mount now and check it is ready for work.

See also:

- [FatFs manual – f\\_mount](#)

### **ff\_diskio\_register**

```
void ff_diskio_register(  
    BYTE pdrv,  
    const ff_diskio_impl_t *diskio_impl)
```

## SPI Flash

The SPI Flash apis allow us to read, write and erase sectors contained within flash memory. When working with flash address spaces, we need to ensure that we tell the ESP-IDF configuration how much flash space is available. We do that in the "make menuconfig" options. The default is 2MBytes. Attempts to access above 2MBytes will be flagged as an error, even if your real storage exceeds that.

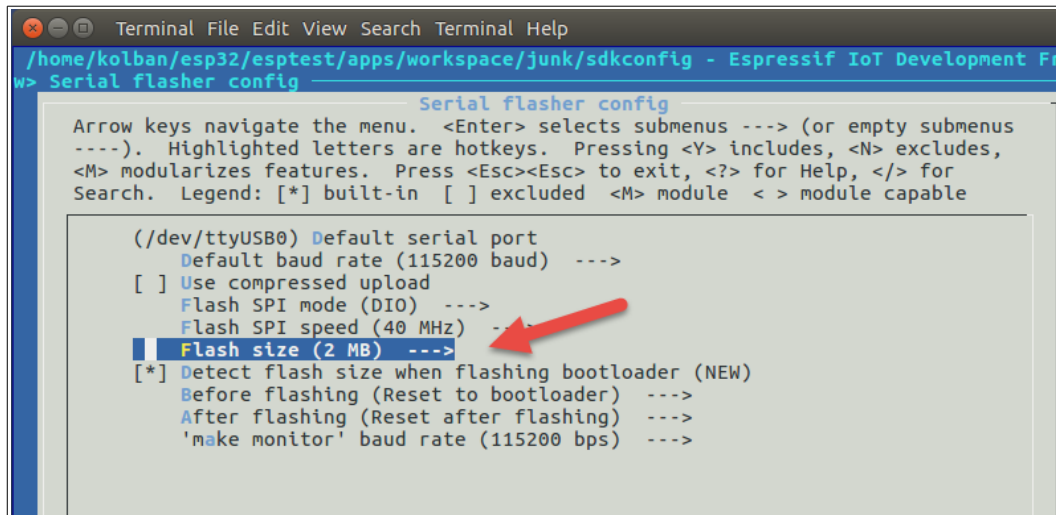

### spi\_flash\_erase\_range

Erase a range of flash storage.

```
esp_err_t spi_flash_erase_range(size_t startAddr, size_t size)
```

Includes:

- #include <esp\_spi\_flash.h>

### spi\_flash\_erase\_sector

Erase a flash sector. Each sector is 4k in size.

```
esp_err_t spi_flash_erase_sector(size_t sector)
```

The sec parameter is the sector number (a sector is 4096 bytes in size).

Includes:

- #include <esp\_spi\_flash.h>

See also:

### **spi\_flash\_get\_chip\_size**

Get the size of the declared storage for the flash device.

```
size_t spi_flash_get_chip_size()
```

The return is the amount of storage that the environment has declared to be available on the flash device.

Includes:

- `#include <esp_spi_flash.h>`

### **spi\_flash\_get\_counters**

```
const spi_flash_counters_t *spi_flash_get_counters()
```

Includes:

- `#include <esp_spi_flash.h>`

### **spi\_flash\_init**

```
void spi_flash_init()
```

Includes:

- `#include <esp_spi_flash.h>`

### **spi\_flash\_mmap**

Map flash storage into the ESP32 address bus.

```
esp_err_t spi_flash_mmap(  
    uint32_t          srcAddr,  
    size_t           size,  
    spi_flash_mmap_memory_t memory,  
    const void**     outPtr,  
    spi_flash_mmap_handle_t* outHandle)
```

The `srcAddr` is the address in flash address range that is the start of the data we are going to map from. It must be located on a 64K boundary (i.e. be evenly divisible by  $64*1024$  which is  $0x1\ 0000$ ).

The `size` is the size of data to be mapped. It will be rounded up to the nearest 64K multiple.

The `memory` parameter is where the memory should be mapped. Choices are:

- `SPI_FLASH_MMAP_DATA` – Map to data memory.

- `SPI_FLASH_MMAP_INST` – Map to instruction memory.

The `outPtr` is the address in the CPU address range where the mapped data can be found.

The `outHandle` is the handle used to release the mapping (if needed) in a call to `spi_flash_munmap`.

Includes:

- `#include <esp_spi_flash.h>`

See also:

- `spi_flash_munmap`
- `spi_flash_mmap_dump`
- `esp_partition_mmap`

### `spi_flash_mmap_dump`

`void spi_flash_mmap_dump()`

An example of output might be:

```
page 0: refcnt=1 paddr=1
page 77: refcnt=1 paddr=2
page 78: refcnt=1 paddr=3
```

Includes:

- `#include <esp_spi_flash.h>`

### `spi_flash_munmap`

Unmap a previously mapped chunk of SPI flash.

`void spi_flash_munmap(spi_flash_mmap_handle_t handle)`

Includes:

- `#include <esp_spi_flash.h>`

See also:

- `spi_flash_mmap`
- `esp_partition_mmap`

### `spi_flash_read`

Read data from flash

```
esp_err_t spi_flash_read(size_t src_addr, void* destAddr, size_t size)
```

The `src_addr` parameter is the address in flash that will be read. The `destAddr` is the address in memory which will be written. The `size` parameter is the size of data to be read.

Includes:

- `#include <spi_flash.h>`

See also:

### **spi\_flash\_reset\_counters**

```
void spi_flash_reset_counters()
```

### **spi\_flash\_write**

Write data to flash

```
esp_err_t spi_flash_write(size_t destAddr, const void* srcAddr, size_t_t size)
```

The `destAddr` is the address in flash which is to be written. The `srcAddr` is the source address in memory from where the new data is to be taken. The `size` parameter is the size of the data to be written.

Includes:

- `#include <spi_flash.h>`

See also:

## **SDMMC**

These API functions provide low level access to the device at the sector level where we can read and write raw bytes. We can access a FAT file system on the device by using the FAT file system APIs.

See also:

- SD, MMC and SDIO interfacing
- FatFs file system
- [ESP-IDF Programming Guide – SD/SDIO/MMC Driver](#)

### **sdmmc\_card\_init**

```
esp_err_t sdmmc_card_init(  
    const sdmmc_host_t* host,  
    sdmmc_card_t* out_card)
```

Includes:

- `#include <sdmmc_cmd.h>`

### **sdmmc\_card\_print\_info**

Print information about the card to the given file stream.

```
void sdmmc_card_print_info(  
    FILE* stream,  
    const sdmmc_card_t* card)
```

- `stream` – The output stream to which to log information.
- `card` – The card to examine.

Includes:

- `#include <sdmmc_cmd.h>`

### **sdmmc\_host\_deinit**

```
esp_err_t sdmmc_host_deinit()
```

Includes:

- `#include <sdmmc_host.h>`

### **sdmmc\_host\_do\_transaction**

```
esp_err_t sdmmc_host_do_transaction(  
    int slot,  
    sdmmc_command_t* cmdinfo)
```

Includes:

- `#include <sdmmc_host.h>`

### **sdmmc\_host\_init**

```
esp_err_t sdmmc_host_init()
```

Includes:

- `#include <sdmmc_host.h>`

### **sdmmc\_host\_init\_slot**

```
esp_err_t sdmmc_host_init_slot(  
    int slot,  
    const sdmmc_slot_config_t *slot_config)
```

Includes:

- `#include <sdmmc_host.h>`

### **sdmmc\_host\_set\_bus\_width**

```
esp_err_t sdmmc_host_set_bus_width(  
    int slot,  
    size_t width)
```

Includes:

- `#include <sdmmc_host.h>`

### **sdmmc\_host\_set\_card\_clk**

```
esp_err_t sdmmc_host_set_card_clk(  
    int slot,  
    uint32_t freq_khz)
```

Includes:

- `#include <sdmmc_host.h>`

### **sdmmc\_io\_enable\_int**

```
esp_err_t sdmmc_io_enable_int(sdmmc_card_t* card)
```

### **sdmmc\_io\_read\_blocks**

```
esp_err_t sdmmc_io_read_blocks(  
    sdmmc_card_t* card,  
    uint32_t      function,  
    uint32_t      addr,  
    void*         dst,  
    size_t        size)
```

### **sdmmc\_io\_read\_byte**

```
esp_err_t sdmmc_io_read_byte(  
    sdmmc_card_t* card,  
    uint32_t      function,  
    uint32_t      reg,  
    uint8_t*      out_byte)
```



### **sdmmc\_io\_read\_bytes**

```
esp_err_t sdmmc_io_read_bytes(  
    sdmmc_card_t* card,  
    uint32_t      function,  
    uint32_t      addr,  
    void*         dst,  
    size_t        size)
```

### **sdmmc\_io\_wait\_int**

```
esp_err_t sdmmc_io_wait_int(  
    sdmmc_card_t* card,  
    TickType_t    timeout_ticks)
```

### **sdmmc\_io\_write\_blocks**

```
esp_err_t sdmmc_io_write_blocks(  
    sdmmc_card_t* card,  
    uint32_t      function,  
    uint32_t      addr,  
    const void*   src,  
    size_t        size)
```

### **sdmmc\_io\_write\_byte**

```
esp_err_t sdmmc_io_write_byte(  
    sdmmc_card_t* card,  
    uint32_t      function,  
    uint32_t      reg,  
    uint8_t       in_byte,  
    uint8_t*      out_byte)
```

### **sdmmc\_io\_write\_bytes**

```
esp_err_t sdmmc_io_write_bytes(  
    sdmmc_card_t* card,  
    uint32_t      function,  
    uint32_t      addr,  
    const void*   src,  
    size_t        size)
```

### **sdmmc\_read\_sectors**

Read sectors from the card.

```
esp_err_t sdmmc_read_sectors(  
    sdmmc_card_t* card,  
    void*         dst,  
    size_t        start_sector,  
    size_t        sector_count)
```

- `card` – The card to read from.
- `dst` – Storage into which to read the sectors. Must be at least `sector_count * card->csd.sector_size` in length.

- `start_sector` – Which sector to start reading from.
- `sector_count` – The number of sectors to read.

Includes:

- `#include <sdmmc_cmd.h>`

### **sdmmc\_write\_sectors**

Write sectors to the card.

```
esp_err_t sdmmc_write_sectors(
    sdmmc_card_t* card,
    const void*   src,
    size_t        start_sector,
    size_t        sector_count)
```

- `card` – The card to write.
- `src` – The data to be written to the card. Must be of size `sector_count * card->csd.sector_size`.
- `start_sector` – Sector on card to start writing.
- `sector_count` – Number of sectors to write.

Includes:

- `#include <sdmmc_cmd.h>`

## **HTTP Client**

See also:

- [ESP-IDF Documentation – ESP HTTP Client](#)

### **esp\_http\_client\_cleanup**

Release any resources associated with the client.

```
esp_err_t esp_http_client_cleanup(esp_http_client_handle_t client)
```

See also:

- `esp_http_client_init`

### **esp\_http\_client\_close**

Close an HTTP session that was previously opened.

```
esp_err_t esp_http_client_close(esp_http_client_handle_t client)
```

See also:

- `esp_http_client_open`

### **esp\_http\_client\_delete\_header**

Remove a previously saved HTTP header.

```
esp_err_t esp_http_client_delete_header(  
    esp_http_client_handle_t client,  
    const char*                key)
```

See also:

- `esp_http_client_set_header`

### **esp\_http\_client\_fetch\_headers**

Retrieve the headers from the response.

```
int esp_http_client_fetch_headers(esp_http_client_handle_t client)
```

The return codes are:

- 0 – No payload length available.
- > 0 – The length of the data as reported by the `Content-Length` HTTP header in the response.
- < 0 – An error was detected.

### **esp\_http\_client\_get\_content\_length**

The content length of the data after the last request.

```
int esp_http_client_get_content_length(esp_http_client_handle_t client)
```

### **esp\_http\_client\_get\_post\_field**

```
int esp_http_client_get_post_field(  
    esp_http_client_handle_t client,  
    char**                    data)
```

## **esp\_http\_client\_get\_status\_code**

Retrieve the status code from the last HTTP request.

```
int esp_http_client_get_status_code(esp_http_client_handle_t client)
```

## **esp\_http\_client\_init**

Initialize the module for making an HTTP request.

```
esp_http_client_handle_t esp_http_client_init(  
    esp_http_client_config_t* config)
```

This must be the first call in our HTTP sequence of commands.

The config contains:

- `char* url` – The URL to the target.
- `char* host`
- `int port`
- `char* username` – When `authType` is `HTTP_AUTH_TYPE_BASIC`, the username for authentication.
- `char *password` – When `authType` is `HTTP_AUTH_TYPE_BASIC`, the password for authentication.
- `esp_http_client_auth_type_t authType` – The type of authentication to perform.  
One of:
  - `HTTP_AUTH_TYPE_NONE`
  - `HTTP_AUTH_TYPE_BASIC`
  - `HTTP_AUTH_TYPE_DIGEST`
- `char* path`
- `char* query`
- `char* cert_pem`
- `esp_http_client_method_t method`
- `int timeout_ms`
- `bool disable_auto_redirect`
- `int max_redirection_count`
- `http_event_handle_cb event_handler` – Event handler for processing HTTP events.

- `esp_http_client_transport_t transport_type` – The type of physical transport.  
One of:
  - `HTTP_TRANSPORT_UNKNOWN`
  - `HTTP_TRANSPORT_OVER_TCP`
  - `HTTP_TRANSPORT_OVER_SSL`
- `int buffer_size`
- `void* user_data`

The event handler is a function with the signature:

```
esp_err_t handler(esp_http_client_event_t* evt)
```

The `esp_http_client_event_t` structure contains:

- `esp_http_client_event_id_t event_id` – The type of event. One of:
  - `HTTP_EVENT_ERROR`
  - `HTTP_EVENT_ON_CONNECTED`
  - `HTTP_EVENT_HEADER_SENT`
  - `HTTP_EVENT_ON_HEADER`
  - `HTTP_EVENT_ON_DATA`
  - `HTTP_EVENT_ON_FINISH`
  - `HTTP_EVENT_DISCONNECTED`
- `esp_http_client_handle_t client` – The handle of the client that is associated with the event.
- `void* data` – Data associated with the event.
- `int data_len` – Length of the data.
- `void* user_data` – The data that was associated with the client during at the time we performed an `esp_http_client_init()`.
- `char* header_key` – When the event type is `HTTP_EVENT_ON_HEADER`, the name of the header.
- `char* header_value` – When the event type is `HTTP_EVENT_ON_HEADER`, the value of the header.

See also:

- `esp_http_client_cleanup`

### **esp\_http\_client\_is\_chunked\_response**

```
bool esp_http_client_is_chunked_response(esp_http_client_handle_t client)
```

### **esp\_http\_client\_open**

Perform an explicit open against the target HTTP server.

```
esp_err_t esp_http_client_open(  
    esp_http_client_handle_t client,  
    int write_len)
```

### **esp\_http\_client\_perform**

Perform an HTTP request.

```
esp_err_t esp_http_client_perform(esp_http_client_handle_t client)
```

Perform an HTTP request using the client handle created in `esp_http_client_init()` or modified from the set calls. This call performs everything needed to send the request. It can be used again after completion for a subsequent call. This is a blocking request that will wait until the request completes or an error is encountered.

See also:

- `esp_http_client_init`

### **esp\_http\_client\_read**

Read data from the HTTP partner.

```
int esp_http_client_read(  
    esp_http_client_handle_t client,  
    char* buffer,  
    int len)
```

The `buffer` contains the storage area into which the data will be stored. The length of the buffer is supplied by `len`. On return, the number of bytes actually retrieved is returned.

### **esp\_http\_client\_set\_header**

```
esp_err_t esp_http_client_set_header(  
    esp_http_client_handle_t client,  
    const char* key,  
    const char* value)
```

See also:

- `esp_http_client_delete_header`

### **esp\_http\_client\_set\_method**

```
esp_err_t esp_http_client_set_method(  
    esp_http_client_handle_t client,  
    esp_http_client_method_t method)
```

The method types are:

- `HTTP_METHOD_GET`
- `HTTP_METHOD_POST`
- `HTTP_METHOD_PUT`
- `HTTP_METHOD_PATCH`
- `HTTP_METHOD_DELETE`

### **esp\_http\_client\_set\_post\_field**

```
esp_err_t esp_http_client_set_post_field(  
    esp_http_client_handle_t client,  
    const char* data,  
    int len)
```

### **esp\_http\_client\_set\_url**

Set the request URL.

```
esp_err_t esp_http_client_set_url(  
    esp_http_client_handle_t client,  
    const char* url)
```

This call will replace the url specified during the configuration.

See also:

- `esp_http_client_init`

### **esp\_http\_client\_write**

Send data to the partner HTTP.

```
int esp_http_client_write(  
    esp_http_client_handle_t client,
```

```
const char*      buffer,  
int              len)
```

Following a call to `esp_http_client_open()`, this call can be used to transmit data to the partner.

See also:

- `esp_http_client_open`

## HTTP Server

### `httpd_query_key_value`

Retrieve a value from the query string by a given key.

```
esp_err_t httpd_query_key_value(  
    const char* query,  
    const char* key,  
    char*      val,  
    size_t     val_size)
```

A query string is the information in a URL that follows the path. Consider the following URL:

```
http://www.example.com?account=1234&state=tx
```

The query string would then be `account=1234&state=tx`.

Within a query string we have key/value pairs. In the example we have two keys `account` and `state` with values `1234` and `tx`. This function allows us to retrieve the value of a given key (assuming it exists).

Includes:

- `#include <http_server.h>`

See also:

- `httpd_req_get_url_query_str`

### `httpd_queue_work`

```
esp_err_t httpd_queue_work(  
    httpd_handle_t handle,  
    httpd_work_fn_t work,  
    void*          arg)
```

Includes:

- `#include <http_server.h>`



## httpd\_register\_uri\_handler

Register a handler for a given incoming request.

```
esp_err_t httpd_register_uri_handler(  
    httpd_handle_t    handle,  
    const httpd_uri_t* uri_handler)
```

The `uri_handler` describes the request to handle. It contains:

- `char* uri`
- `httpd_method_t method`
- `esp_err_t (*handler)(httpd_req_t *r)`
- `void* user_ctx`

The handler function is called when a matching incoming request is received. The parameter to the handler function is an instance of an `httpd_req_t` which contains the following data:

- `httpd_handle_t handle`
- `int method`
- `char uri[HTTPD_MAX_URI_LEN+1]`
- `size_t content_len`
- `void* user_ctx`
- `void* sess_ctx`
- `httpd_free_sess_ctx_fn_t free_ctx`

Includes:

- `#include <http_server.h>`

See also:

- `httpd_start`
- `httpd_unregister_uri_handler`

## httpd\_req\_get\_hdr\_value\_len

Get the length of a named header in the request.

```
size_t httpd_req_get_hdr_value_len(  
    httpd_req_t* request,  
    const char* field)
```

If the field is not present, 0 is returned. The value of the header can be retrieved using a call to `httpd_req_get_hdr_value_str()`.

Includes:

- `#include <http_server.h>`

See also:

- `httpd_req_get_hdr_value_str`

## `httpd_req_get_hdr_value_str`

Get the value of a request header.

```
esp_err_t httpd_req_get_hdr_value_str(  
    httpd_req_t* request,  
    const char* field,  
    char*       val,  
    size_t      val_size)
```

Retrieve the value of a request header. The size of the value can be retrieved from a previous call to `httpd_req_get_hdr_value_len()`.

Includes:

- `#include <http_server.h>`

See also:

- `httpd_req_get_hdr_value_len`

## `httpd_req_get_url_query_len`

Retrieve the size of the query string length.

```
size_t httpd_req_get_url_query_len(httpd_req_t *request)
```

A query string is the information in a URL that follows the path. Consider the following URL:

```
http://www.example.com?account=1234&state=tx
```

The query string would then be `account=1234&state=tx`.

This function returns the size of a buffer that would be needed to hold the string. This is the number of characters plus one (to hold the null terminator required for C strings). It is typically used in conjunction with `httpd_req_get_url_query_str()` to retrieve the string from the request for processing.

Includes:

- `#include <http_server.h>`

See also:

- `httpd_req_get_url_query_str`

## `httpd_req_get_url_query_str`

Retrieve the query string from the URL.

```
esp_err_t httpd_req_get_url_query_str(  
    httpd_req_t* request,  
    char*        buf,  
    size_t       buf_len)
```

A query string is the information in a URL that follows the path. Consider the following URL:

```
http://www.example.com?account=1234&state=tx
```

The query string would then be `account=1234&state=tx`.

The `buf` parameter points to a buffer large enough to hold the query string while `buf_len` is the size of that buffer in bytes. A previous call to `httpd_req_get_url_query_len()` is typically made to determine the length of the buffer and then that buffer allocated to be of sufficient size.

Includes:

- `#include <http_server.h>`

See also:

- `httpd_req_get_url_query_len`

## `httpd_req_recv`

```
int httpd_req_recv(  
    httpd_req_t* request,  
    char*        buf,  
    size_t       buf_len)
```

Includes:

- `#include <http_server.h>`

## `httpd_req_to_sockfd`

Obtain the socket file descriptor of the received request.

```
int httpd_req_to_sockfd(httpd_req_t* request)
```

When called, we get the underlying socket file descriptor of the incoming client request.

Includes:

- `#include <http_server.h>`

### `httpd_resp_send`

Send a response to a received request.

```
esp_err_t httpd_resp_send(  
    httpd_req_t* request,  
    const char* buf,  
    size_t      buf_len)
```

The `buf` points to the data to return and `buf_len` is the length of that data.

Includes:

- `#include <http_server.h>`

### `httpd_resp_send_404`

Convenience function to send an HTTP 404 response.

```
esp_err_t httpd_resp_send_404(httpd_req_t* request)
```

The HTTP response of 404 means that the resource was not found.

Includes:

- `#include <http_server.h>`

See also:

- [Wikipedia: HTTP 404](#)

### `httpd_resp_send_chunk`

```
esp_err_t httpd_resp_send_chunk(  
    httpd_req_t* request,  
    const char* buf,  
    size_t      buf_len)
```

After sending a series of chunks of data, you are expected to make a final call with a buffer length of 0 to indicate that this is the end of the response.

Includes:

- `#include <http_server.h>`

### `httpd_resp_set_hdr`

Set a response header in the response to be sent for a request.

```
esp_err_t httpd_resp_set_hdr(  
    httpd_req_t* request,  
    const char* field,  
    const char* value)
```

Set a response header in the response to be sent for a request.

Includes:

- `#include <http_server.h>`

See also:

- `httpd_resp_send`

### **httpd\_resp\_set\_status**

Set the status code on a response to a request.

```
esp_err_t httpd_resp_set_status(  
    httpd_req_t* request,  
    const char* status)
```

Set the status code on a response to a request. The status is not actually transmitted until a call to `httpd_resp_send()` is made.

Includes:

- `#include <http_server.h>`

See also:

- `httpd_resp_send`

### **httpd\_resp\_set\_type**

Set the content type of the response to a request.

```
esp_err_t httpd_resp_set_type(  
    httpd_req_t* request,  
    const char* type)
```

Set the content type on a response to a request. The response type is added to the header but is not actually transmitted until a call to `httpd_resp_send()` is made. The storage for the string passed in for `type` must be valid until after the send has completed.

Includes:

- `#include <http_server.h>`

See also:

- `httpd_resp_send`

## `httpd_send`

Send a raw response to a received request.

```
int httpd_send(  
    httpd_req_t* request,  
    const char* buf,  
    size_t      buf_len)
```

The request was passed in through the registered handler when a client request arrives.

Includes:

- `#include <http_server.h>`

## `httpd_sess_get_ctx`

```
void *httpd_sess_get_ctx(httpd_handle_t handle, int sockfd)
```

Includes:

- `#include <http_server.h>`

## `httpd_sess_update_timestamp`

```
esp_err_t httpd_sess_update_timestamp(httpd_handle_t handle, int sockfd)
```

Includes:

- `#include <http_server.h>`

## `httpd_set_recv_override`

```
esp_err_t httpd_set_recv_override(  
    httpd_req_t* request,  
    httpd_recv_func_t recv_func)
```

Includes:

- `#include <http_server.h>`

## `httpd_set_send_override`

```
esp_err_t httpd_set_send_override(  
    httpd_req_t* request,  
    httpd_send_func_t send_func)
```

Includes:

- `#include <http_server.h>`

## **httpd\_start**

Start an instance of the HTTP server.

```
esp_err_t httpd_start(  
    httpd_handle_t* handle,  
    const httpd_config_t* config)
```

The server instance can subsequently be stopped by calling `httpd_stop()`.

The `handle` is populated as a reference to the newly started instance. The `config` parameter contains:

- `unsigned task_priority`
- `size_t stack_size`
- `uint16_t server_port`
- `uint16_t ctrl_port`
- `uint16_t max_open_sockets`
- `uint16_t max_uri_handlers`
- `uint16_t max_resp_handlers`
- `uint16_t backlog_conn`
- `bool lru_purge_enable`
- `uint16_t recv_wait_timeout`
- `uint16_t send_wait_timeout`

Includes:

- `#include <http_server.h>`

See also:

- `httpd_stop`

## **httpd\_stop**

Stop a previously started HTTP server instance.

```
esp_err_t httpd_stop(httpd_handle_t handle)
```

The handle is populated by a previous call to `httpd_start()`. This function is blocking which means that when it is called it does not return until the server has stopped.

Includes:

- `#include <http_server.h>`

See also:

- `httpd_start`

### **httpd\_trigger\_sess\_close**

```
esp_err_t httpd_trigger_sess_close(httpd_handle_t handle, int sockfd)
```

Includes:

- `#include <http_server.h>`

### **httpd\_unregister\_uri\_handler**

Unregister a previously registered handler for the given URI and method pair.

```
esp_err_t httpd_unregister_uri_handler(  
    httpd_handle_t handle,  
    const char* uri,  
    httpd_method_t method)
```

Includes:

- `#include <http_server.h>`

See also:

- `httpd_register_uri_handler`
- `httpd_unregister_uri`

### **httpd\_unregister\_uri**

Unregister all previously registered handlers for the given URI.

```
esp_err_t httpd_unregister_uri(  
    httpd_handle_t handle,  
    const char* uri)
```

Includes:

- `#include <http_server.h>`

See also:

- `httpd_unregister_uri_handler`
- `httpd_register_uri_handler`



## Cryptography

### base64\_decode

Decode a base64 encoded string.

```
unsigned char* base64_decode(const unsigned char* src, size_t len, size_t* outlen)
```

- `src` – The data to be decoded.
- `len` – The size (in bytes) of the data to be decoded.
- `outLen` – Returns the length of the decoded data.

The return is a `malloced()` buffer that contains the decoded data. The data should be freed.

Includes:

- `#include <crypto/base64.h>`

See also:

- [base64url-encoding](#)

### base64\_encode

Encode data to base64 encoding.

```
unsigned char* base64_encode(const unsigned char* src, size_t len, size_t* outlen)
```

- `src` – The data to be encoded.
- `len` – The size (in bytes) of the data to be encoded.
- `outLen` – Returns the length of the encoded data. May be NULL if not needed.

The return is a `malloced()` buffer that contains the encoded data. It is NULL terminated. The data should be freed.

Includes:

- `#include <crypto/base64.h>`

See also:

- [base64url-encoding](#)

## esp\_sha

Perform a hash key calculation on data.

```
void esp_sha(  
    esp_sha_type      shaType,  
    const unsigned char* input,  
    size_t            ilen,  
    unsigned char*    output)
```

- `shaType` – The SHA algorithm to use.
  - SHA1
  - SHA2\_256
  - SHA2\_384
  - SHA2\_512
- `input` – The input data to parse.
- `ilen` – The length in bytes of the input data.
- `output` – A buffer to hold the data. The size of the data buffer is a function of the `shaType`:
  - SHA1 – 20
  - SHA2\_256 – 32
  - SHA2\_384 – 48
  - SHA2\_512 – 64

Example:

```
uint8_t shaData[20];  
esp_sha(SHA1, input, strlen(input), shaData);
```

Includes:

- `#include <hwcrypto/sha.h>`

## esp\_sha\_block

```
void esp_sha_block(esp_sha_type shaType, const void *dataBlock, bool is_firstBlock)
```

- `shaType`
- `dataBlock`
- `isFirstBlock`

### **esp\_sha\_lock\_engine**

```
void esp_sha_lock_engine(esp_sha_type sha_type)
```

### **esp\_sha\_lock\_memory\_block**

```
void esp_sha_lock_memory_block(void)
```

### **esp\_sha\_read\_digest\_state**

```
void esp_sha_read_digest_state(esp_sha_type sha_type, void* digest_state)
```

### **esp\_sha\_try\_lock\_engine**

```
bool esp_sha_try_lock_engine(esp_sha_type sha_type)
```

### **esp\_sha\_unlock\_engine**

```
void esp_sha_unlock_engine(esp_sha_type sha_type)
```

### **esp\_sha\_wait\_idle**

```
void esp_sha_wait_idle(void)
```

## **Hash processing**

Calculate hash values of data buffers. We can calculate three distinct types of hash known as CRC8 (8 bit result), CRC16 (16 bit result) and CRC32 (32 bit result). For each type, there are two functions. One returns a big endian piece of data while the other returns a little endian piece of data.

The polynomials used to calculate the hashes are:

- CRC8 –  $x^8+x^2+x^1+1$
- CRC16 –  $x^{16}+x^{12}+x^5+1$
- CRC32 –  $x^{32}+x^{26}+x^{23}+x^{22}+x^{16}+x^{12}+x^{11}+x^{10}+x^8+x^7+x^5+x^4+x^2+x^1+1$

If the buffer CRC is accumulative, we can supply the previous value as the first parameter. For the first call, supply 0.

### **crc32\_le**

```
uint32_t crc32_le(uint32_t crc, uint8_t const* buf, uint32_t len)
```

Includes:

- `#include <rom/crc.h>`

### **crc32\_be**

```
uint32_t crc32_be(uint32_t crc, uint8_t const* buf, uint32_t len)
```

Includes:

- `#include <rom/crc.h>`

### **crc16\_le**

```
uint16_t crc16_le(uint16_t crc, uint8_t const* buf, uint32_t len)
```

Includes:

- `#include <rom/crc.h>`

### **crc16\_be**

```
uint16_t crc16_be(uint16_t crc, uint8_t const* buf, uint32_t len)
```

Includes:

- `#include <rom/crc.h>`

### **crc8\_le**

```
uint8_t crc8_le(uint8_t crc, uint8_t const* buf, uint32_t len)
```

Includes:

- `#include <rom/crc.h>`

### **crc8\_be**

```
uint8_t crc8_be(uint8_t crc, uint8_t const* buf, uint32_t len)
```

Includes:

- `#include <rom/crc.h>`

## **Hardware Timers**

### **timer\_disable\_intr**

```
esp_err_t timer_disable_intr(  
    timer_group_t group_num,  
    timer_idx_t timer_num)
```

- `group_num` – One of:
  - `TIMER_GROUP_0`
  - `TIMER_GROUP_1`

- `timer_num` – One of:
  - `TIMER_0`
  - `TIMER_1`

Includes:

- `#include <driver/timer.h>`

### `timer_enable_intr`

```
esp_err_t timer_enable_intr(
    timer_group_t group_num,
    timer_idx_t timer_num)
```

- `group_num` – One of:
  - `TIMER_GROUP_0`
  - `TIMER_GROUP_1`
- `timer_num` – One of:
  - `TIMER_0`
  - `TIMER_1`

Includes:

- `#include <driver/timer.h>`

### `timer_get_alarm_value`

Get the value at which a timer event should fire.

```
esp_err_t timer_get_alarm_value(
    timer_group_t group_num,
    timer_idx_t timer_num,
    uint64_t *alarm_value)
```

- `group_num` – One of:
  - `TIMER_GROUP_0`
  - `TIMER_GROUP_1`
- `timer_num` – One of:
  - `TIMER_0`
  - `TIMER_1`

Includes:

- `#include <driver/timer.h>`

### **timer\_get\_config**

```
esp_err_t timer_get_config(  
    timer_group_t group_num,  
    timer_idx_t timer_num,  
    timer_config_t *config)
```

- `group_num` – One of:
  - `TIMER_GROUP_0`
  - `TIMER_GROUP_1`
- `timer_num` – One of:
  - `TIMER_0`
  - `TIMER_1`
- `config` – Contains
  - `alarm_en`
  - `counter_en`
  - `counter_dir`
  - `intr_type`
  - `auto_reload`
  - `divider`

Includes:

- `#include <driver/timer.h>`

### **timer\_get\_counter\_time\_sec**

Read the counter value as a double in seconds.

```
esp_err_t timer_get_counter_time_sec(  
    timer_group_t group_num,  
    timer_idx_t timer_num,  
    double *time)
```

- `group_num` – One of:
  - `TIMER_GROUP_0`
  - `TIMER_GROUP_1`

- `timer_num` – One of:
  - `TIMER_0`
  - `TIMER_1`

Includes:

- `#include <driver/timer.h>`

### **timer\_get\_counter\_value**

Get the value of the timer.

```
esp_err_t timer_get_counter_value(  
    timer_group_t group_num,  
    timer_idx_t timer_num,  
    uint64_t *timer_val)
```

- `group_num` – One of:
  - `TIMER_GROUP_0`
  - `TIMER_GROUP_1`
- `timer_num` – One of:
  - `TIMER_0`
  - `TIMER_1`

Includes:

- `#include <driver/timer.h>`

### **timer\_group\_intr\_enable**

```
esp_err_t timer_group_intr_enable(  
    timer_group_t group_num,  
    uint32_t en_mask)
```

- `group_num` – One of:
  - `TIMER_GROUP_0`
  - `TIMER_GROUP_1`

Includes:

- `#include <driver/timer.h>`

## timer\_group\_intr\_disable

```
esp_err_t timer_group_intr_disable(  
    timer_group_t group_num,  
    uint32_t disable_mask)
```

- `group_num` – One of:
  - `TIMER_GROUP_0`
  - `TIMER_GROUP_1`

### Includes:

- `#include <driver/timer.h>`

## timer\_isr\_register

```
esp_err_t timer_isr_register(  
    timer_group_t group_num,  
    timer_idx_t timer_num,  
    void (*fn)(void*), void * arg,  
    int intr_alloc_flags,  
    timer_isr_handle_t *handle)
```

- `group_num` – One of:
  - `TIMER_GROUP_0`
  - `TIMER_GROUP_1`
- `timer_num` – One of:
  - `TIMER_0`
  - `TIMER_1`

### Includes:

- `#include <driver/timer.h>`

## timer\_init

```
esp_err_t timer_init(  
    timer_group_t group_num,  
    timer_idx_t timer_num,  
    timer_config_t* config)
```

- `group_num` – One of:
  - `TIMER_GROUP_0`
  - `TIMER_GROUP_1`
- `timer_num` – One of:
  - `TIMER_0`



- TIMER\_1
- config – Contains
  - alarm\_en
  - counter\_en
  - counter\_dir
  - intr\_type
  - auto\_reload
  - divider

Includes:

- #include <driver/timer.h>

### timer\_pause

Pause a specific timer.

```
esp_err_t timer_pause(
    timer_group_t group_num,
    timer_idx_t timer_num)
```

- group\_num – One of:
  - TIMER\_GROUP\_0
  - TIMER\_GROUP\_1
- timer\_num – One of:
  - TIMER\_0
  - TIMER\_1

### timer\_set\_counter\_value

Set the counter value to a specific value.,

```
esp_err_t timer_set_counter_value(
    timer_group_t group_num,
    timer_idx_t timer_num,
    uint64_t load_val)
```

- group\_num – One of:
  - TIMER\_GROUP\_0
  - TIMER\_GROUP\_1

- `timer_num` – One of:
  - `TIMER_0`
  - `TIMER_1`

Includes:

- `#include <driver/timer.h>`

### **timer\_start**

Start a specific timer.

```
esp_err_t timer_start(
    timer_group_t group_num,
    timer_idx_t timer_num)
```

- `group_num` – One of:
  - `TIMER_GROUP_0`
  - `TIMER_GROUP_1`
- `timer_num` – One of:
  - `TIMER_0`
  - `TIMER_1`

Includes:

- `#include <driver/timer.h>`

### **timer\_set\_alarm**

Determine if an alarm should fire.

```
esp_err_t timer_set_alarm(
    timer_group_t group_num,
    timer_idx_t timer_num,
    timer_alarm_t alarm_en)
```

- `group_num` – One of:
  - `TIMER_GROUP_0`
  - `TIMER_GROUP_1`
- `timer_num` – One of:
  - `TIMER_0`
  - `TIMER_1`
- `alarm_en` – One of:

- `TIMER_ALARM_DIS`
- `TIMER_ALARM_EN`

Includes:

- `#include <driver/timer.h>`

### `timer_set_alarm_value`

Define the value at which an alarm event should occur when reached by the timer.

```
esp_err_t timer_set_alarm_value(  
    timer_group_t group_num,  
    timer_idx_t timer_num,  
    uint64_t alarm_value)
```

- `group_num` – One of:
  - `TIMER_GROUP_0`
  - `TIMER_GROUP_1`
- `timer_num` – One of:
  - `TIMER_0`
  - `TIMER_1`

Includes:

- `#include <driver/timer.h>`

### `timer_set_auto_reload`

Determine whether or not the timer should reload following an alarm event.

```
esp_err_t timer_set_auto_reload(  
    timer_group_t group_num,  
    timer_idx_t timer_num,  
    timer_autoreload_t reload)
```

- `group_num` – One of:
  - `TIMER_GROUP_0`
  - `TIMER_GROUP_1`
- `timer_num` – One of:
  - `TIMER_0`
  - `TIMER_1`

- reload – One of:
  - `TIMER_AUTORELOAD_DIS` – Do not load the counter after an alarm event.
  - `TIMER_AUTORELOAD_EN` – Load the counter after an alarm event.

**Includes:**

- `#include <driver/timer.h>`

**timer\_set\_counter\_mode**

Set the mode of a specific counter.

```
esp_err_t timer_set_counter_mode(
    timer_group_t group_num,
    timer_idx_t timer_num,
    timer_count_dir_t counter_dir)
```

- group\_num – One of:
  - `TIMER_GROUP_0`
  - `TIMER_GROUP_1`
- timer\_num – One of:
  - `TIMER_0`
  - `TIMER_1`
- counter\_dir – One of:
  - `TIMER_COUNT_DOWN`
  - `TIMER_COUNT_UP`

**Includes:**

- `#include <driver/timer.h>`

**timer\_set\_divider**

Set the underlying clock divider.

```
esp_err_t timer_set_divider(
    timer_group_t group_num,
    timer_idx_t timer_num,
    uint16_t divider)
```

- group\_num – One of:

- `TIMER_GROUP_0`
- `TIMER_GROUP_1`
- `timer_num` – One of:
  - `TIMER_0`
  - `TIMER_1`

Includes:

- `#include <driver/timer.h>`

## Pthreads

See also:

- [POSIX Threads Programming](#)

### `esp_pthread_get_cfg`

Retrieve the current pthread configuration.

```
esp_err_t esp_pthread_get_cfg(esp_pthread_cfg_t* p)
```

The `esp_pthread_cfg_t` contains:

- `size_t stack_size` – The stack size for a new thread.
- `size_t prio` – The thread priority.

Includes:

- `#include <esp_pthread.h>`

### `esp_pthread_init`

```
esp_err_t esp_pthread_init(void)
```

Includes:

- `#include <esp_pthread.h>`

### `esp_pthread_set_cfg`

Set the current pthread configuration.

```
esp_err_t esp_pthread_set_cfg(const esp_pthread_cfg_t* cfg)
```

The `esp_thread_cfg_t` contains:

- `size_t stack_size` – The stack size for a new thread.
- `size_t prio` – The thread priority.

Includes:

- `#include <esp_thread.h>`

## `pthread_cancel`

### **CURRENTLY NOT IMPLEMENTED**

Cancel/Terminate a running thread.

```
int pthread_cancel(pthread_t thread)
```

- `thread` – A handle to a thread created by a call to `pthread_create()`.

See also:

- [man\(3\) – pthread\\_cancel](#)

## `pthread_create`

Create an instance of a pthread.

```
int pthread_create(
    pthread_t*          thread,
    const pthread_attr_t* attr,
    void* (*startRoutine)(void *),
    void*               arg)
```

- `thread` – The address for the handle of the thread.
- `attr` – Optional attributes to be associated with the thread. Use NULL for the defaults.
- `startRoutine` – The entry point into the function to be invoked.
- `arg` – Parameter to be passed to the started function.

Example:

```
void* myThreadFunc(void *data) {
    ESP_LOGD(LOG_TAG, "myThreadFunc called ...");
    return nullptr;
}
```

```
pthread_t t1;
```

```
pthread_create(&t1, nullptr, myThreadFunc, nullptr);
```

Includes:

- `#include <pthread.h>`

See also:

- [man\(3\) - pthread\\_create](#)

### **pthread\_cond\_broadcast**

```
int pthread_cond_broadcast(pthread_cond_t* cv)
```

### **pthread\_cond\_destroy**

```
int pthread_cond_destroy(pthread_cond_t* cv)
```

### **pthread\_cond\_init**

```
int pthread_cond_init(pthread_cond_t* cv, const pthread_condattr_t* attr)
```

### **pthread\_cond\_signal**

```
int pthread_cond_signal(pthread_cond_t* cv)
```

### **pthread\_cond\_timedwait**

```
int pthread_cond_timedwait(  
    pthread_cond_t* cv,  
    pthread_mutex_t* mut,  
    const struct timespec* to)
```

### **pthread\_cond\_wait**

```
int pthread_cond_wait(pthread_cond_t* cv, pthread_mutex_t* mut)
```

### **pthread\_condattr\_init**

```
int pthread_condattr_init(pthread_condattr_t* attr)
```

### **pthread\_detach**

Flag the thread as detached.

```
int pthread_detach(pthread_t thread)
```

- `thread` – The thread to flag as detached.

Includes:

- `#include <pthread.h>`

See also:

- [man\(3\) - pthread\\_detach](#)

## pthread\_equal

Compare two thread handles for equality.

```
int pthread_equal(pthread_t t1, pthread_t t2)
```

Includes:

- `#include <pthread.h>`

See also:

- [man\(3\) - pthread\\_equal](#)

## pthread\_getspecific

Retrieve a reference to the thread specific data.

```
void* pthread_getspecific(pthread_key_t key)
```

- `key` – The key used to reference the thread specific data.

Includes:

- `#include <pthread.h>`

See also:

- [man\(3\) - pthread\\_getspecific](#)

## pthread\_join

Block the calling thread until another thread has completed.

```
int pthread_join(pthread_t thread, void** retval)
```

- `thread` – A thread that was previously created with `pthread_create()`.
- `retval` – The return value from the now completed thread.

Includes:

- `#include <pthread.h>`

See also:

- [man\(3\) - pthread\\_join](#)

## pthread\_key\_create

Create a thread specific key.



```
int pthread_key_create(pthread_key_t* key, void (*destructor)(void*))
```

- `key` – The key to be created.
- `destructor` – A destructor to be called to release a value for the key.

Includes:

- `#include <pthread.h>`

See also:

- [man\(3\) – pthread\\_key\\_create](#)

### **pthread\_key\_delete**

```
int pthread_key_delete(pthread_key_t key)
```

Includes:

- `#include <pthread.h>`

See also:

- [man\(3\) – pthread\\_key\\_delete](#)

### **pthread\_once**

Perform a routine once.

```
int pthread_once(  
    pthread_once_t* once_control,  
    void (*init_routine)(void))
```

This is a blocking call that invokes the `init_routine` once and once only no matter how many times it is called.

- `once_control` – A static opaque instance that contains the state of whether it was called or not. Should be initialized to `PTHREAD_ONCE_INIT`.
- `init_routine` – A function to be called only ever once.

Includes:

- `#include <pthread.h>`

See also:

- [man\(3\) - pthread\\_once](#)

## pthread\_mutex\_destroy

```
int pthread_mutex_destroy(pthread_mutex_t* mutex)
```

Includes:

- `#include <pthread.h>`

See also:

- [man\(3\) – pthread\\_mutex\\_destroy](#)

## pthread\_mutex\_init

Initialize the mutex.

```
int pthread_mutex_init(pthread_mutex_t* mutex, const pthread_mutexattr_t* attr)
```

When we create a mutex, we declare an object of type `pthread_mutex` but it is not initially initialized. Before we can use it, we must initialize it with a call to `pthread_mutex_init()` passing in the address of it.

Includes:

- `#include <pthread.h>`

See also:

- [man\(3\) – pthread\\_mutex\\_init](#)

## pthread\_mutexattr\_destroy

```
int pthread_mutexattr_destroy(pthread_mutexattr_t* attr)
```

Includes:

- `#include <pthread.h>`

See also:

- [man\(3\) – pthread\\_mutexattr\\_destroy](#)

## pthread\_mutexattr\_gettype

```
int pthread_mutexattr_gettype(const pthread_mutexattr_t* attr, int* type)
```

Includes:

- `#include <pthread.h>`

See also:

- [man\(3\) – pthread\\_mutexattr\\_gettype](#)

## **pthread\_mutexattr\_init**

`int pthread_mutexattr_init(pthread_mutexattr_t* attr)`

Includes:

- `#include <pthread.h>`

See also:

- [man\(3\) – pthread\\_mutexattr\\_init](#)

## **pthread\_mutexattr\_settype**

`int pthread_mutexattr_settype(pthread_mutexattr_t* attr, int type)`

The allowable types are:

- `PTHREAD_MUTEX_NORMAL`
- `PTHREAD_MUTEX_RECURSIVE`

Includes:

- `#include <pthread.h>`

See also:

- [man\(3\) – pthread\\_mutexattr\\_settype](#)

## **pthread\_mutex\_lock**

Lock an unlocked mutex or wait for the lock to free if already locked.

`int pthread_mutex_lock(pthread_mutex_t* mutex)`

Includes:

- `#include <pthread.h>`

See also:

- `pthread_mutex_init`
- `pthread_mutex_unlock`
- [man\(3\) – pthread\\_mutex\\_lock](#)

## **pthread\_mutex\_trylock**

`int pthread_mutex_trylock(pthread_mutex_t* mutex)`

Includes:

- `#include <pthread.h>`

See also:

- [man\(3\) – pthread\\_mutex\\_trylock](#)

### **pthread\_mutex\_unlock**

Unlock a mutex previously locked.

```
int pthread_mutex_unlock(pthread_mutex_t* mutex)
```

Includes:

- `#include <pthread.h>`

See also:

- `pthread_mutex_init`
- `pthread_mutex_lock`
- [man\(3\) – pthread\\_mutex\\_unlock](#)

### **pthread\_self**

Get the handle to our own thread.

```
pthread_t pthread_self(void)
```

When called within a thread, returns our own thread handle.

Includes:

- `#include <pthread.h>`

See also:

- [man\(3\) – pthread\\_self](#)

### **pthread\_setspecific**

Set a value associated with a key for this thread instance.

```
int pthread_setspecific(pthread_key_t key, const void* value)
```

- `key` – The key to be used to reference the thread specific data.
- `value` – A pointer to the thread specific data.

Includes:

- `#include <pthread.h>`

See also:

- [man\(3\) – pthread\\_setspecific](#)

## sched\_yield

```
int sched_yield(void)
```

## Watchdog processing

The watchdog functions are all about monitoring the liveness of tasks to ensure that they aren't stuck in loops or otherwise starving.

At the highest level, there are two watchdog types. First there is the interrupt watchdog timer. This verifies that the FreeRTOS task switching is executing as desired. This can be enabled with the `make menuconfig`. The timer interval is also specified there and defaults to 300msecs.

The second watchdog type is that of the task watchdog timer. This can be set on a per task basis and ensures that the task is not being starved.

If we look at the following diagram, each of the circles represents a call within a task to `esp_task_wdt_reset()`. This resets the timer for the watchdog for that task. As long as the next call to `esp_task_wdt_reset()` occurs before the watchdog timer expires, all is well.

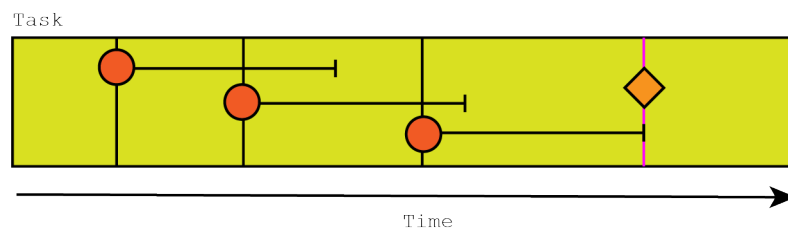

However, the diamond in the picture shows an example of not calling `esp_task_wdt_reset()` in time. The timer for the watchdog expires and we have an expired watchdog event. This event may be either a simple warning log message or it may be panic that causes the device to halt or reboot.

The watchdog functions can be controlled by the master settings defined by running "`make menuconfig`". There are entries specified there which define whether or not task specific watchdog functions are enabled and, if so, how long between watchdog checks. The interval is measured in seconds with a default of 5.

There are a number of Watchdog settings. These include:

```

[*] Interrupt watchdog
(300) Interrupt watchdog timeout (ms)
[*] Also watch CPU1 tick interrupt
[*] Initialize Task Watchdog Timer on startup
[ ] Invoke panic handler on Task Watchdog timeout
(5) Task Watchdog timeout period (seconds)
[*] Watch CPU0 Idle Task
[*] Watch CPU1 Idle Task

```

- `CONFIG_INT_WDT` – Should the interrupt watchdog be enabled?
- `CONFIG_INT_WDT_TIMEOUT_MS` – Timeout in milliseconds looking for FreeRTOS tick. This can only be specified in the configuration and not supplied at runtime.
- `TASK_WDT` – Initialize the task watchdog service at startup.
- `TASK_WDT_TIMEOUT_S` – The default task watchdog timeout in seconds. This defaults to 5 seconds.
- `TASK_WDT_CHECK_IDLE_TASK` – Watch the CPU0 idle task
- `CONFIG_TASK_WDT_CHECK_IDLE_TASK_CPU0`
- `CONFIG_TASK_WDT_CHECK_IDLE_TASK_CPU1`

If a watchdog timer expires before being fed, then a message is logged (by default). Alternatively, we can invoke a panic handler which can:

- print the registers and halt
- print the registers and reboot
- silently reboot
- invoke the built-in `gdb stub`

If a task watchdog fires and we haven't asked it to panic, a message similar to the following is produced:

```

Task watchdog got triggered. The following tasks did not reset the watchdog in time:
- My Task (CPU 0/1)
Tasks currently running:
CPU 0: IDLE
CPU 1: IDLE

```

A task can be associated with the watchdog subsystem by calling `esp_task_wdt_add()` and can be unregistered by calling `esp_task_wdt_delete()`. It is important to unregister a task from the watchdog subsystem when the task is deleted.

If we know in advanced that a task is going to be performing some function where it will not be able to feed the watchdog, we can remove our registration while performing that task and then re-add the registration after performing our expensive operation.

If the interrupt watchdog fires, we get an error as follows:

```

Guru Meditation Error: Core  0 panic'ed (Interrupt wdt timeout on CPU0)
Core 0 register dump:
PC      : 0x400d2324  PS      : 0x00060e34  A0      : 0x00000000  A1      : 0x3ffcd4c0
0x400d2324: hardLoopTask(void*) at
/home/kolban/esp32/esptest/apps/workspace/watchdog/main/main.cpp:29

A2      : 0x00000000  A3      : 0x00000000  A4      : 0x00000000  A5      : 0x00000000
A6      : 0x00000000  A7      : 0x00000000  A8      : 0x00060e20  A9      : 0x3ffcd4a0
A10     : 0x0000000a  A11     : 0x00000000  A12     : 0x00060023  A13     : 0x3ffc2fa8
A14     : 0x00000001  A15     : 0x00000000  SAR     : 0x00000000  EXCCAUSE: 0x00000005
EXCVADDR: 0x00000000  LBEG    : 0x400014fd  LEND    : 0x4000150d  LCOUNT : 0xffffffff3

Backtrace: 0x400d2324:0x3ffcd4c0 0x7fffffff:0x3ffcd4e0
0x400d2324: hardLoopTask(void*) at
/home/kolban/esp32/esptest/apps/workspace/watchdog/main/main.cpp:29

```

## See also:

- `esp_task_wdt_add`
- `esp_task_wdt_delete`
- [ESP-IDF Docs: Watchdogs](#)

## `esp_int_wdt_init`

Initialize the interrupt watchdog.

```
void esp_int_wdt_init()
```

Includes:

- `#include <esp_int_wdt.h>`

See also:

- `esp_task_wdt_init`

## `esp_task_wdt_add`

Register a task for being watched by the watchdog.

```
esp_err_t esp_task_wdt_add(TaskHandle_t handle)
```

This call registers the given task for monitoring by the watchdog subsystem. The task is then responsible for regularly calling `esp_task_wdt_reset()` to indicate that it is alive and well. We can call `esp_task_wdt_delete()` to indicate that we no longer wish to be included in the task monitoring. We should not attempt to register a task prior to calling `esp_task_wdt_init()` to initialize the task monitoring subsystem.

The `TaskHandle_t` type is equivalent to the FreeRTOS `xTaskHandle` type. We can retrieve the current task handle for the currently running task by calling

`xTaskGetCurrentTaskHandle()` or we can simply pass in NULL and we will implicitly use our current task.

If a task is registered with the task watchdog, it is important to delete that registration when the task is deleted. Obviously a deleted task will no longer be able to feed the watchdog and the explicit action of deleting a task does not implicitly delete a watchdog registration.

Includes:

- `#include <esp_task_wdt.h>`

See also:

- `esp_task_wdt_reset`
- `esp_task_wdt_delete`
- `esp_task_wdt_init`
- `xTaskGetCurrentTaskHandle`

### **esp\_task\_wdt\_deinit**

De-initialize the task watchdog timer.

```
esp_err_t esp_task_wdt_deinit()
```

This call effectively undoes the registration of task watchdogs performed by a previous call to `esp_task_wdt_init()`. The de-initialization can only be performed when all previously registered watchdog tasks have themselves been deleted.

Includes:

- `#include <esp_task_wdt.h>`

See also:

- `esp_task_wdt_init`
- `esp_task_wdt_delete`

### **esp\_task\_wdt\_delete**

Delete an association between a task and watchdog.

```
esp_err_t esp_task_wdt_delete(Task_Handle_t taskHandle)
```

The task should previously have been registered by a call to `esp_task_wdt_add()`. If the task no longer wishes to be watched for liveness or else is about to end, then we should call this function to remove the task from the list of monitored tasks by the watchdog.

The `TaskHandle_t` type is equivalent to the FreeRTOS `xTaskHandle` type. We can retrieve the current task handle for the currently running task by calling



`xTaskGetCurrentTaskHandle()` or we can supply `NULL` to implicitly use our current task handle.

Includes:

- `#include <esp_task_wdt.h>`

See also:

- `esp_task_wdt_add`

### `esp_task_wdt_feed` - **DEPRECATED**

Register a task or feed a task watchdog.

```
void esp_task_wdt_feed()
```

This function is deprecated and has been replaced with calls to `esp_task_wdt_add()` and `esp_task_wdt_reset()`.

If called for the first time on a given FreeRTOS task then the task becomes registered as one that is being monitored for liveness. It must be regularly called from then on to ensure that the watchdog is fed.

Includes:

- `#include <esp_task_wdt.h>`

See also:

- `esp_task_wdt_add`
- `esp_task_wdt_reset`

### `esp_task_wdt_init`

Initialize the task watchdog subsystem.

```
esp_err_t esp_task_wdt_init(uint32_t timeout, bool panic)
```

The `timeout` is the time in seconds before which we report a problem for a stalled task. If `panic` is set to `true`, then in the event of a problem detection, we will raise a panic.

We can call this function subsequent to a previous initialization to change the initialization parameters.

Includes:

- `#include <esp_task_wdt.h>`

See also:

- `esp_task_wdt_deinit`

- `esp_task_wdt_add`

### `esp_task_wdt_reset`

Indicate that the current task is still alive.

```
esp_err_t esp_task_wdt_reset()
```

Calling this function indicates that the task is still alive. This function is logically considered to feed the watchdog. The function should be regularly called from within a task that has previously been registered with a call to `esp_task_wdt_add()`.

Includes:

- `#include <esp_task_wdt.h>`

See also:

- `esp_task_wdt_add`

### `esp_task_wdt_status`

Determine whether the given task is registered with the watchdog subsystem.

```
esp_err_t esp_task_wdt_status(TaskHandle_t handle)
```

When we call this function and the task is registered with the watchdog subsystem, the response is `ESP_OK`. If it is not registered, the response is `ESP_ERR_NOT_FOUND`.

Includes:

- `#include <esp_task_wdt.h>`

See also:

- `esp_task_wdt_add`
- `esp_task_wdt_delete`

## Heap management

See also:

- Working with memory
- [ESP-IDF Docs – Heap Memory Allocation](#)

### `heap_trace_record_t`

This is a structure which holds a trace record created by an allocation or release of memory. It contains:

- `uint32_t ccount` – Timestamp of record.

- `void* address` – Address that was allocated or released.
- `size_t size` – Size of the block that was requested and allocated.
- `void* allocated_by[CONFIG_HEAP_TRACING_STACK_DEPTH]` – Call stack of allocator
- `void* freed_by[CONFIG_HEAP_TRACING_STACK_DEPTH]` – Call stack of releasor. If the memory has not been released, then these pointers will be `nullptr` (0).

The depth of the stack PC back trace saved for each record is configurable within "make menuconfig" and exposed by the `CONFIG_HEAP_TRACING_STACK_DEPTH` definition.

The size of a record is `3 + 2 * CONFIG_HEAP_TRACING_STACK_DEPTH` words.

### heap\_caps\_add\_region

Add a region of memory to the heap allocatable storage areas.

```
esp_err_t heap_caps_add_region(intptr_t start, intptr_t end)
```

Includes:

- `#include <esp_heap_caps_init.h>`

### heap\_caps\_add\_region\_with\_caps

```
esp_err_t heap_caps_add_region_with_caps(
    const uint32_t caps[],
    intptr_t      start,
    intptr_t      end)
```

### heap\_caps\_calloc

```
void* heap_caps_calloc(size_t n, size_t size, uint32_t caps)
```

### heap\_caps\_calloc\_prefer

```
void* heap_caps_calloc_prefer(size_t n, size_t size, size_t num, ...)
```

### heap\_caps\_check\_integrity

```
bool heap_caps_check_integrity(uint32_t caps, bool print_errors)
```

This function returns true if all the heaps pass their integrity checks and false if at least one of them fails.

The `caps` parameter is the boolean or of the different heaps to be examined.

If `print_errors` is true, errors will be logged if and when and integrity check fails.

Includes

- `#include <esp_heap_caps.h>`

See also:

- [Heap corruption](#)

### **heap\_caps\_check\_integrity\_addr**

Check the heap integrity for a block at a specific address.

```
bool heap_caps_check_integrity_addr(intptr_t addr, bool print_errors)
```

This function returns true if the heaps integrity checks out ok for the given address and false if the integrity check fails.

The `addr` parameter is a memory address contained within an allocated block.

If `print_errors` is true, errors will be logged if and when and integrity check fails.

Includes

- `#include <esp_heap_caps.h>`

See also:

- [Heap corruption](#)

### **heap\_caps\_check\_integrity\_all**

Check the heap integrity on all heap blocks.

```
bool heap_caps_check_integrity_all(bool print_errors)
```

This function returns true if all the heaps pass their integrity checks and false if at least one of them fails.

If `print_errors` is true, errors will be logged if and when and integrity check fails.

Includes

- `#include <esp_heap_caps.h>`

See also:

- [Heap corruption](#)

### **heap\_caps\_dump**

```
void heap_caps_dump(uint32_t caps)
```

Includes

- `#include <esp_heap_caps.h>`

### **heap\_caps\_dump\_all**

`void heap_caps_dump_all()`

#### **Includes**

- `#include <esp_heap_caps.h>`

### **heap\_caps\_enable\_nonos\_stack\_heaps**

`void heap_caps_enable_nonos_stack_heaps()`

### **heap\_caps\_free**

`void heap_caps_free(void* ptr)`

Release memory previously allocated by a call to `heap_caps_malloc()`.

#### **Includes**

- `#include <esp_heap_caps.h>`

### **heap\_caps\_get\_free\_size**

`size_t heap_caps_get_free_size(uint32_t caps)`

#### **The capabilities are:**

- `MALLOC_CAP_EXEC` – Able to run executable code
- `MALLOC_CAP_32BIT` – Allow for aligned 32 bit access
- `MALLOC_CAP_8BIT` – 8/16/32 bit data access
- `MALLOC_CAP_DMA` – Able to be accessed by DMA
- `MALLOC_CAP_SPIRAM` – Must be in SPI SRAM
- `MALLOC_CAP_INTERNAL` – Must be internal memory.
- `MALLOC_CAP_DEFAULT` – Non capability specific.

#### **Includes**

- `#include <esp_heap_caps.h>`

#### **See also:**

- [Heap diagnosis / memory leaks](#)

### **heap\_caps\_get\_minimum\_free\_size**

`size_t heap_caps_get_minimum_free_size(uint32_t caps)`

The capabilities are:

- `MALLOC_CAP_EXEC` – Able to run executable code
- `MALLOC_CAP_32BIT` – Allow for aligned 32 bit access
- `MALLOC_CAP_8BIT` – 8/16/32 bit data access
- `MALLOC_CAP_DMA` – Able to be accessed by DMA
- `MALLOC_CAP_SPIRAM` – Must be in SPI SRAM
- `MALLOC_CAP_INTERNAL` – Must be internal memory.
- `MALLOC_CAP_DEFAULT` – Non capability specific.

Includes

- `#include <esp_heap_caps.h>`

### **heap\_caps\_get\_largest\_free\_block**

`size_t heap_caps_get_largest_free_block(uint32_t caps)`

The capabilities are:

- `MALLOC_CAP_EXEC` – Able to run executable code
- `MALLOC_CAP_32BIT` – Allow for aligned 32 bit access
- `MALLOC_CAP_8BIT` – 8/16/32 bit data access
- `MALLOC_CAP_DMA` – Able to be accessed by DMA
- `MALLOC_CAP_SPIRAM` – Must be in SPI SRAM
- `MALLOC_CAP_INTERNAL` – Must be internal memory.
- `MALLOC_CAP_DEFAULT` – Non capability specific.

Includes

- `#include <esp_heap_caps.h>`

### **heap\_caps\_get\_info**

`void heap_caps_get_info(multi_heap_info_t* info, uint32_t caps)`

The capabilities are:

- `MALLOC_CAP_EXEC` – Able to run executable code
- `MALLOC_CAP_32BIT` – Allow for aligned 32 bit access

- `MALLOC_CAP_8BIT` – 8/16/32 bit data access
- `MALLOC_CAP_DMA` – Able to be accessed by DMA
- `MALLOC_CAP_SPIRAM` – Must be in SPI SRAM
- `MALLOC_CAP_INTERNAL` – Must be internal memory.
- `MALLOC_CAP_DEFAULT` – Non capability specific.

The `multi_heap_info_t` contains:

- `size_t total_free_bytes` – The count of free bytes in the heap.
- `size_t total_allocated_bytes` – The size of allocated bytes in the heap.
- `size_t largest_free_block` – The size of the largest free block in the heap.
- `size_t minimum_free_bytes` – The smallest size of free bytes that has been seen.
- `size_t allocated_blocks` – The number of allocated blocks in this heap.
- `size_t free_blocks` – The number of free blocks in the heap.
- `size_t total_blocks` – The total number of blocks in the heap.

Includes

- `#include <esp_heap_caps.h>`

**heap\_caps\_init**

`void heap_caps_init()`

**heap\_caps\_malloc**

`void* heap_caps_malloc(size_t size, uint32_t caps)`

Allocate heap storage of a given size fulfilling a capability. The capabilities are:

- `MALLOC_CAP_EXEC` – Able to run executable code
- `MALLOC_CAP_32BIT` – Allow for aligned 32 bit access
- `MALLOC_CAP_8BIT` – 8/16/32 bit data access
- `MALLOC_CAP_DMA` – Able to be accessed by DMA
- `MALLOC_CAP_SPIRAM` – Must be in SPI SRAM
- `MALLOC_CAP_INTERNAL` – Must be internal memory.
- `MALLOC_CAP_DEFAULT` – Non capability specific.

## Includes

- `#include <esp_heap_caps.h>`

## See also:

- Working with memory

## heap\_caps\_malloc\_extmem\_enable

```
void heap_caps_malloc_extmem_enable(size_t limit)
```

## heap\_caps\_malloc\_prefer

```
void *heap_caps_malloc_prefer(size_t size, size_t num, ...)
```

## heap\_caps\_print\_heap\_info

```
void heap_caps_print_heap_info(uint32_t caps)
```

## Here is an example of the output:

```
Heap summary for capabilities 0x00000004:
  At 0x3fffae6e0 len 57632 free 35704 allocated 21684 min_free 35656
    largest_free_block 35676 alloc_blocks 51 free_blocks 2 total_blocks 53
  At 0x3fffc4c08 len 111608 free 111572 allocated 0 min_free 111572
    largest_free_block 111572 alloc_blocks 0 free_blocks 1 total_blocks 1
  At 0x3fffe0440 len 15296 free 15260 allocated 0 min_free 15260
    largest_free_block 15260 alloc_blocks 0 free_blocks 1 total_blocks 1
  At 0x3fffe4350 len 113840 free 113804 allocated 0 min_free 113804
    largest_free_block 113804 alloc_blocks 0 free_blocks 1 total_blocks 1
Totals:
  free 276340 allocated 21684 min_free 276292 largest_free_block 113804
```

## The capabilities are:

- `MALLOC_CAP_EXEC` – Able to run executable code
- `MALLOC_CAP_32BIT` – Allow for aligned 32 bit access
- `MALLOC_CAP_8BIT` – 8/16/32 bit data access
- `MALLOC_CAP_DMA` – Able to be accessed by DMA
- `MALLOC_CAP_SPIRAM` – Must be in SPI SRAM
- `MALLOC_CAP_INTERNAL` – Must be internal memory.
- `MALLOC_CAP_DEFAULT` – Non capability specific.

## Includes

- `#include <esp_heap_caps.h>`



## heap\_caps\_realloc

`void* heap_caps_realloc(void* ptr, size_t size, int caps)`

Reallocate memory.

The capabilities are:

- `MALLOC_CAP_EXEC` – Able to run executable code
- `MALLOC_CAP_32BIT` – Allow for aligned 32 bit access
- `MALLOC_CAP_8BIT` – 8/16/32 bit data access
- `MALLOC_CAP_DMA` – Able to be accessed by DMA
- `MALLOC_CAP_SPIRAM` – Must be in SPI SRAM
- `MALLOC_CAP_INTERNAL` – Must be internal memory.
- `MALLOC_CAP_DEFAULT` – Non capability specific.

Includes

- `#include <esp_heap_caps.h>`

## heap\_caps\_realloc\_prefer

`void *heap_caps_realloc_prefer(void *ptr, size_t size, size_t num, ...)`

## heap\_trace\_dump

`void heap_trace_dump(void)`

Includes:

- `#include <esp_heap_trace.h>`

See also:

- Heap diagnosis / memory leaks

## heap\_trace\_get

Obtain a record from the trace.

`esp_err_t heap_trace_get(size_t index, heap_trace_record_t* record)`

Obtain an indexed record from the trace. The record is identified by its `index` which starts at 0. The record is copied into the storage area pointed to be `record`.

A record contains:

- `uint32_t ccount` – The time when the memory was allocated/released. The least significant bit encodes the CPU that performed the request.
- `void* address` – The address of the storage allocated or released.
- `size_t size` – The amount of storage allocated or released.
- `void* allocated_by[CONFIG_HEAP_TRACING_STACK_DEPTH]` – An array of program counters showing the back trace of the allocator.
- `void* freed_by[CONFIG_HEAP_TRACING_STACK_DEPTH]` – An array of program counters showing the back trace of the releasor.

Includes:

- `#include <esp_heap_trace.h>`

See also:

- [Heap diagnosis / memory leaks](#)

### **heap\_trace\_get\_count**

Get the number of used records in the trace.

```
size_t heap_trace_get_count(void)
```

Includes:

- `#include <esp_heap_trace.h>`

See also:

- [Heap diagnosis / memory leaks](#)

### **heap\_trace\_init\_standalone**

```
esp_err_t heap_trace_init_standalone(
    heap_trace_record_t* record_buffer,
    size_t                num_records
)
```

- `record_buffer` – An array of records used to hold trace information. The storage supplied here must be good while tracing is enabled and must be in RAM.
- `num_records` – The number of entries in the array.

A record contains:

- `uint32_t ccount` – The time when the memory was allocated/released. The least significant bit encodes the CPU that performed the request.
- `void* address` – The address of the storage allocated or released.

- `size_t size` – The amount of storage allocated or released.
- `void* allocated_by[CONFIG_HEAP_TRACING_STACK_DEPTH]` – An array of program counters showing the back trace of the allocator.
- `void* freed_by[CONFIG_HEAP_TRACING_STACK_DEPTH]` – An array of program counters showing the back trace of the releasor.

Includes:

- `#include <esp_heap_trace.h>`

See also:

- [Heap diagnosis / memory leaks](#)

### heap\_trace\_resume

Resume a previously started and then stopped trace.

```
esp_err_t heap_trace_resume(void)
```

Includes:

- `#include <esp_heap_trace.h>`

See also:

- [Heap diagnosis / memory leaks](#)

### heap\_trace\_start

```
esp_err_t heap_trace_start(heap_trace_mode_t mode)
```

- `mode` – The type of tracing we wish to perform:
  - `HEAP_TRACE_ALL` – Record all allocations and releases.
  - `HEAP_TRACE_LEAKS` – Record all allocations and when a release is encountered, remove the record that reflected the allocation.

Includes:

- `#include <esp_heap_trace.h>`

See also:

- [Heap diagnosis / memory leaks](#)

### heap\_trace\_stop

```
esp_err_t heap_trace_stop(void)
```

Stop tracing. The opposite of `heap_trace_start()`.

Includes:

- `#include <esp_heap_trace.h>`

See also:

- [Heap diagnosis / memory leaks](#)

## ULP Co-processor

### RTC\_SLOW\_MEM

A constant that defines the start of slow memory (`0x5000 0000`).

Includes:

- `#include <esp32/ulp.h>`

### ulp\_process\_macros\_and\_load

```
esp_err_t ulp_process_macros_and_load(  
    uint32_t      load_addr,  
    const ulp_insn_t* program,  
    size_t*       psize)
```

- `load_addr` – The offset into slow memory where the program will be loaded.
- `program` – Array with the program.
- `psize` – The size of the ULP co-processor program to load.

Includes:

- `#include <esp32/ulp.h>`

### ulp\_load\_binary

Load the ULP program from flash memory into slow memory for ULP co-processor execution.

```
esp_err_t ulp_load_binary(  
    uint32_t      load_addr,  
    const uint8_t* program_binary, |  
    size_t        program_size)
```

- `load_addr` – The offset into slow memory where the program will be loaded.
- `program_binary` – Address of the program as found memory to load.
- `program_size` – The size of the ULP co-processor program to load in 32bit words.

Take care with the program size. It is **not** the number of bytes of the program but is instead the number of 32bit words that make up the program. If we imagine that we have loaded the program into our normal RAM storage and that it starts at `pBegin` and ends at `pEnd`, to load it into slow memory for execution we would execute:

```
ulp_load_binary(  
    0,  
    pBegin,  
    (pEnd - pBegin) / 4  
)
```

Includes:

- `#include <esp32/ulp.h>`

See also:

- `ulp_run`

### `ulp_run`

```
esp_err_t ulp_run(uint32_t entry_point)
```

- `entry_point` – The entry point of the ULP co-processor program to start. This is an index of words with 0 being the first word.

Includes:

- `#include <esp32/ulp.h>`

See also:

### `ulp_set_wakeup_period`

```
esp_err_t ulp_set_wakeup_period(  
    size_t period_index,  
    uint32_t period_us)
```

Includes:

- `#include <esp32/ulp.h>`

## AWS-IoT

When using the AWS IoT SDK, one must call `aws_iot_mqtt_yield()` periodically. Calling this function checks for subscription messages and causes the heartbeat ping messages to be sent.

See also:

- [AWS IoT](#)
- [AWS IoT Embedded C Device SDK](#)

## IoT\_Error\_t

NETWORK_PHYSICAL_LAYER_CONNECTED	6
NETWORK_MANUALLY_DISCONNECTED	5
NETWORK_ATTEMPTING_RECONNECT	4
NETWORK_RECONNECTED	3
MQTT_NOTHING_TO_READ	2
MQTT_CONNACK_CONNECTION_ACCEPTED	1
SUCCESS	0
FAILURE	-1
NULL_VALUE_ERROR	-2
TCP_CONNECTION_ERROR	-3
...	more

## aws\_iot\_is\_autoreconnect\_enabled

Determine if auto-reconnect is enabled.

```
bool aws_iot_is_autoreconnect_enabled(AWS_IoT_Client *pClient)
```

See also:

- `aws_iot_mqtt_autoreconnect_set_status`

## aws\_iot\_mqtt\_attempt\_reconnect

```
IoT_Error_t aws_iot_mqtt_attempt_reconnect(AWS_IoT_Client *pClient)
```

Includes:

- `#include <aws_iot_mqtt_client_interface.h>`

## aws\_iot\_mqtt\_autoreconnect\_set\_status

Enabled or disable auto-reconnect.

```
IoT_Error_t aws_iot_mqtt_autoreconnect_set_status(  
    AWS_IoT_Client* pClient,  
    bool            newStatus)
```

Includes:

- `#include <aws_iot_mqtt_client.h>`

See also:

- `aws_iot_is_autoreconnect_enabled`

### **aws\_iot\_mqtt\_connect**

Connect to the AWS IoT service.

```
IoT_Error_t aws_iot_mqtt_connect(  
    AWS_IoT_Client*      pClient,  
    const IoT_Client_Connect_Params* pConnectParams)
```

The `pConnectParams` is a pointer to a structure containing:

- `char struct_id`
- `MQTT_Ver_t MQTTVersion`
- `const char *pClientID`
- `uint16_t clientIdLen`
- `uint16_t keepAliveIntervalInSec`
- `bool isCleanSession`
- `bool isWillMsgPresent`
- `IoT_MQTT_Will_Options will`
- `char *pUsername`
- `uint16_t usernamelen`
- `char *pPassword`
- `uint16_t passwordLen`

Includes:

- `#include <aws_iot_mqtt_client_interface.h>`

### **aws\_iot\_mqtt\_disconnect**

```
IoT_Error_t aws_iot_mqtt_disconnect(AWS_IoT_Client *pClient)
```

Includes:

- `#include <aws_iot_mqtt_client_interface.h>`

### **aws\_iot\_mqtt\_get\_client\_state**

Get the current state of the client.

```
ClientState aws_iot_mqtt_get_client_state(AWS_IoT_Client *pClient)
```

Client state is one of:

- `CLIENT_STATE_INVALID = 0,`
- `CLIENT_STATE_INITIALIZED = 1,`
- `CLIENT_STATE_CONNECTING = 2,`
- `CLIENT_STATE_CONNECTED_IDLE = 3,`
- `CLIENT_STATE_CONNECTED_YIELD_IN_PROGRESS = 4,`
- `CLIENT_STATE_CONNECTED_PUBLISH_IN_PROGRESS = 5,`
- `CLIENT_STATE_CONNECTED_SUBSCRIBE_IN_PROGRESS = 6,`
- `CLIENT_STATE_CONNECTED_UNSUBSCRIBE_IN_PROGRESS = 7,`
- `CLIENT_STATE_CONNECTED_RESUBSCRIBE_IN_PROGRESS = 8,`
- `CLIENT_STATE_CONNECTED_WAIT_FOR_CB_RETURN = 9,`
- `CLIENT_STATE_DISCONNECTING = 10,`
- `CLIENT_STATE_DISCONNECTED_ERROR = 11,`
- `CLIENT_STATE_DISCONNECTED_MANUALLY = 12,`
- `CLIENT_STATE_PENDING_RECONNECT = 13`

### **aws\_iot\_mqtt\_get\_network\_disconnected\_count**

Get the number of disconnects that have occurred due to errors.

```
uint32_t aws_iot_mqtt_get_network_disconnected_count(AWS_IoT_Client *pClient)
```

### **aws\_iot\_mqtt\_get\_next\_packet\_id**

Get the next packet id.

```
uint16_t aws_iot_mqtt_get_next_packet_id(AWS_IoT_Client *pClient)
```



## aws\_iot\_mqtt\_init

Initialize the MQTT client.

```
IoT_Error_t aws_iot_mqtt_init(  
    AWS_IoT_Client*      pClient,  
    const IoT_Client_Init_Params* pInitParams)
```

The `pInitParams` points to a structure which contains:

- `bool enableAutoReconnect`
- `char* pHostURL`
- `uint16_t port`
- `const char* pRootCALocation`
- `const char* pDeviceCertLocation`
- `const char* pDevicePrivateKeyLocation`
- `uint32_t mqttPacketTimeout_ms`
- `uint32_t mqttCommandTimeout_ms`
- `uint32_t tlsHandshakeTimeout_ms`
- `bool isSSLHostnameVerify`
- `iot_disconnect_handler disconnectHandler`
- `void* disconnectHandlerData`

Includes:

- `#include <aws_iot_mqtt_client_interface.h>`

See also:

## aws\_iot\_mqtt\_is\_client\_connected

Determine if the device is currently connected.

```
bool aws_iot_mqtt_is_client_connected(AWS_IoT_Client *pClient)
```

## aws\_iot\_mqtt\_publish

```
IoT_Error_t aws_iot_mqtt_publish(  
    AWS_IoT_Client*      pClient,  
    const char*          pTopicName,  
    uint16_t             topicNameLen,  
    IoT_Publish_Message_Params* pParams)
```

- pClient
- pTopicName
- topicNameLen
- pParams – A structure that includes:
  - QoS qos – Quality of service.
  - uint8\_t isRetained – Is this a retained message. Not supported by AWS IoT.
  - uint8\_t isDup – Is this message a duplicate.
  - uint16\_t id – Handled automatically.
  - void \*payload – Pointer to the payload to be published.
  - size\_t payloadLen – Length of the payload.

Includes:

- #include <aws\_iot\_mqtt\_client\_interface.h>

### aws\_iot\_mqtt\_reset\_network\_disconnected\_count

Reset the network disconnect error counter to zero.

```
void aws_iot_mqtt_reset_network_disconnected_count(AWS_IoT_Client *pClient)
```

### aws\_iot\_mqtt\_resubscribe

```
IoT_Error_t aws_iot_mqtt_resubscribe(AWS_IoT_Client *pClient)
```

Includes:

- #include <aws\_iot\_mqtt\_client\_interface.h>

### aws\_iot\_mqtt\_set\_connect\_params

Set the connection parameters.

```
IoT_Error_t aws_iot_mqtt_set_connect_params(
    AWS_IoT_Client*          pClient,
    const IoT_Client_Connect_Params* pNewConnectParams)
```

The pNewConnectParams is a pointer to a structure containing:

- char struct\_id
- MQTT\_Ver\_t MQTTVersion

- `const char *pClientID`
- `uint16_t clientIdLen`
- `uint16_t keepAliveIntervallInSec`
- `bool isCleanSession`
- `bool isWillMsgPresent`
- `IoT_MQTT_Will_Options will`
- `char *pUsername`
- `uint16_t usernamelen`
- `char *pPassword`
- `uint16_t passwordLen`

### **aws\_iot\_mqtt\_set\_disconnect\_handler**

Set the IoT client disconnect handler.

```
IoT_Error_t aws_iot_mqtt_set_disconnect_handler(
    AWS_IoT_Client*    pClient,
    iot_disconnect_handler pDisconnectHandler,
    void*              pDisconnectHandlerData)
```

Invoke a function when the client disconnects due to an error.

### **aws\_iot\_mqtt\_subscribe**

Subscribe to a topic.

```
IoT_Error_t aws_iot_mqtt_subscribe(
    AWS_IoT_Client* pClient,
    const char*     pTopicName,
    uint16_t        topicNameLen,
    QoS             qos,
    pApplicationHandler_t pApplicationHandler,
    void*           pApplicationHandlerData)
```

- `pClient` – Reference to the client.
- `pTopicName` – The name of the topic.
- `topicNameLen` – The length of the name of the topic.
- `qos` – Quality of service.
- `pApplicationHandler` – Handler function for this subscription.

- `pApplicationHandlerData` – Data for the handler function.

The callback handler for a subscription has the following signature:

```
typedef void (*pApplicationHandler_t)(
    AWS_IoT_Client* pClient,
    char*          pTopicName,
    uint16_t       topicNameLen,
    IoT_Publish_Message_Params* pParams,
    void*          pClientData);
```

Includes:

- `#include <aws_iot_mqtt_client_interface.h>`

### **aws\_iot\_mqtt\_unsubscribe**

```
IoT_Error_t aws_iot_mqtt_unsubscribe(
    AWS_IoT_Client* pClient,
    const char*     pTopicFilter,
    uint16_t        topicFilterLen)
```

Includes:

- `#include <aws_iot_mqtt_client_interface.h>`

### **aws\_iot\_mqtt\_yield**

```
IoT_Error_t aws_iot_mqtt_yield(
    AWS_IoT_Client *pClient,
    uint32_t timeout_ms)
```

Includes:

- `#include <aws_iot_mqtt_client_interface.h>`

## **Console**

The functions of the console processor can be divided into categories including line editing, argument processing/decomposition, argument parsing and command dispatch.

The line editor is based on the `linenoise` library. The argument parsing library is `argtable3`.

A typical application will likely:

- Call `esp_console_init()` to initialize the console subsystem.
- Call `linenoise` APIs to configure input processing.
- Loop getting lines of input by calling `linenoise()`.

- For each line, calling `esp_console_run()` to process the line.

See also:

- [linenoise](#)
- [ESP32 Documentation – Console](#)
- [Example – Console Example](#)
- [Github: antires/linenoise](#)
- [argtable.org](#)

### **esp\_console\_cmd\_register**

Register a command with the command processor.

```
esp_err_t esp_console_cmd_register(const esp_console_cmd_t* cmd)
```

The `cmd` structure includes:

- `const char* command` – The name of the command.
- `const char* help` – Help text for the command.
- `const char* hint` – Hint for the command. Can be NULL for not hint.
- `esp_console_cmd_func_t func` – Function to implement the command. The signature of the target function is:
  - `int myFunc(int argc, char** argv)`
- `void* argtable` – The `argtable3` argument table.

Includes:

- `#include <esp_console.h>`

See also:

- `argtable`

### **esp\_console\_deinit**

De-initialize the console subsystem releasing any resources that may have been allocated.

```
esp_err_t esp_console_deinit()
```

Includes:

- `#include <esp_console.h>`

### **esp\_console\_get\_completion**

```
void esp_console_get_completion(const char* buf, linenoiseCompletions* lc)
```

Includes:

- `#include <esp_console.h>`

### **esp\_console\_get\_hint**

```
const char *esp_console_get_hint(const char* buf, int* color, int* bold)
```

Includes:

- `#include <esp_console.h>`

### **esp\_console\_init**

Initialize the console subsystem.

```
esp_err_t esp_console_init(const esp_console_config_t* config)
```

The config structure contains:

- `max_cmdline_length` – Length of command line buffer measured in bytes/characters.
- `max_cmdline_args` – Maximum number of command line arguments to be parsed.
- `int hint_color` – ASCII color code of hint text.
- `int hint_bold` – Set to 1 for hint text to be boldened.

Includes:

- `#include <esp_console.h>`

### **esp\_console\_register\_help\_command**

Register a command called "help" that generates help output.

```
esp_err_t esp_console_register_help_command()
```

Includes:

- `#include <esp_console.h>`

### **esp\_console\_run**

Process an individual line of input that was received.

```
esp_err_t esp_console_run(const char* cmdline, int* cmd_ret)
```

- `cmdline` – A string to be parsed and executed.
- `ret` – The return code from the executed command (if it was run).

The function return code is `ESP_OK` if the command was run. It is recommended to examine the response and log if the result is not `ESP_OK`. For example, if the user enters an unknown command then the result will not be `ESP_OK` and we can log a failure. A command not found us the code `ESP_ERR_NOT_FOUND`.

Includes:

- `#include <esp_console.h>`

### **esp\_console\_split\_argv**

Parse a string into its constituent parts.

```
size_t esp_console_split_argv(char* line, char** argv, size_t argv_size)
```

A command passed to a C program has its parameters passed as an array of strings with a count of the number of strings available.

- `line` – The line to be split into its constituents parts.
- `argv` – An array of pointers to strings which is populated by the call.
- `size` – The size of the array of pointers to strings supplied on input.

On return, the number of slots used in the `argv` array and hence populated.

Includes:

- `#include <esp_console.h>`

### **linenoise**

While `linenoise` is not technically ESP-IDF code it is distributed with the ESP-IDF distribution and knowledge of its use is important for processing console inputs. This library provides line editing for the current line being entered. The features include:

- A prompt for input.
- Cursor keys for back forward.
- Insertion and deletion of characters.
- Previous line retrieval.

We have some boiler plate to set up the serial inputs that must be performed before using `linenoise`:

```
setvbuf(stdin, NULL, _IONBF, 0);
setvbuf(stdout, NULL, _IONBF, 0);
esp_vfs_dev_uart_set_rx_line_endings(ESP_LINE_ENDINGS_CR);
esp_vfs_dev_uart_set_tx_line_endings(ESP_LINE_ENDINGS_CRLF);
ESP_ERROR_CHECK(uart_driver_install(CONFIG_CONSOLE_UART_NUM, 256, 0, 0, NULL, 0));
esp_vfs_dev_uart_use_driver(CONFIG_CONSOLE_UART_NUM);
```

Let us now break down what this code is doing. First we have `setvbuf()`. This controls what kind of buffering is being performed on those IO streams. Passing in `_IONBUF` requests that there be no buffering at all. What that means is that the moment a character is available or to be sent, it will be delivered without any form of accumulation.

Next we define the line endings being used.

See also:

- [ESP-IDF: Console Example](#)
- [Github: antires/linenoise](#)
- `esp_vfs_dev_uart_set_rx_line_endings`
- `esp_vfs_dev_uart_set_tx_line_endings`
- `esp_vfs_dev_uart_use_driver`
- `uart_driver_install`

## linenoise

Read a line of input.

```
char* linenoise(const char* prompt)
```

The prompt is shown to the user and then we block until we have received a line. At that point, the line is returned. The storage for the line is on the heap and must be released through a call to `linenoiseFree`.

When text

See also:

- `linenoiseFree`

## linenoiseAddCompletion

Return a possible completion for a user entered line.

```
void linenoiseAddCompletion(linenoiseCompletions*, const char*)
```



When the user enters a line, we can complete that line. A callback is invoked and it is that callback that would make one or more calls to this function to return possible selections for the completion.

See also:

- `linenoiseSetCompletionCallback`

### **linenoiseClearScreen**

Clear the screen.

```
void linenoiseClearScreen(void)
```

### **linenoiseFree**

Release the resources for a line that was returned by linenoise.

```
void linenoiseFree(void* ptr)
```

See also:

- `linenoise`

### **linenoiseHistoryAdd**

Add a line to the history of previously entered lines.

```
int linenoiseHistoryAdd(const char* line)
```

When we add to the history, we can use the up and down cursor keys to retrieve this line in the future.

### **linenoiseHistorySetMaxLen**

The number of historical lines to remember.

```
int linenoiseHistorySetMaxLen(int len)
```

The number of historical lines to remember. A default of 0 means that we are not remembering any lines.

### **linenoiseHistorySave**

Save the history of remembered lines.

```
int linenoiseHistorySave(const char* filename)
```

- `filename` – A file into which the history lines will be written.

### **linenoiseHistoryLoad**

Load the history of remembered lines.

```
int linenoiseHistoryLoad(const char* filename)
```

- `filename` – A file from which the previously saved history lines will be read.

### **linenoiseSetCompletionCallback**

Register a completion callback.

```
void linenoiseSetCompletionCallback(linenoiseCompletionCallback *)
```

When the user presses the TAB key, we can complete the line that the user is entering. Since it our responsibility to complete the line, we register a callback function which is called and gives us control over what to return as completions. The signature for the callback function is:

```
void completion(const char* buf, linenoiseCompletions* lc)
```

The `buf` is the user entered line (so far) and the `lc` is the handle to the current completions. We would call `linenoiseAddCompletion()` to add a completion choice.

See also:

- `linenoiseAddCompletion`

### **linenoiseSetFreeHintsCallback**

```
void linenoiseSetFreeHintsCallback(linenoiseFreeHintsCallback *)
```

### **linenoiseSetHintsCallback**

```
void linenoiseSetHintsCallback(linenoiseHintsCallback *)
```

### **linenoiseSetMultiLine**

Enable or disable multi line editing.

```
void linenoiseSetMultiLine(int ml)
```

A value of 1 will enable multi line editing while a value of 0 will disable it.

By default, text entered will cause the cursor to move right. When we reach the end of the screen, the entered text will scroll left meaning that you will no longer see the initial

data you entered. With multi line editing enabled, when we reach the end of the screen, new data will be entered in the line beneath.

## linenoisePrintKeyCodes

```
void linenoisePrintKeyCodes(void)
```

## argtable

Imagine a command line that looks like:

```
doSomething -f fileName -s 100 --output /tmp/x.txt
```

If we studying this command we might say that the command is `doSomething` and it has some flags/parameters associated with it. The purpose of the `argtable` library is to parse such a command line into its constituent components. Generically, the command line is considered to be a set of flags/options with their associated parameters. Further, each flag/option may have a value of a specific type. Here are a selection:

- `-n name` – A string type.
- `-f /tmp/myfile.txt` – A filename type.
- `-c 100` – An integer type.
- `--cost 9.99` – A decimal type.

Each option/flag can have a short form (a single character prefixed by a dash) or a long form (a string prefixed by two dashes).

For each flag/option, we can specify the minimum and maximum times the flag/option can occur on the command line. Specifying a minimum value of 0 means it is optional. Specifying a maximum count of 1 means that it may only appear once. The maximum must always be greater or equal to the minimum.

The ESP-IDF distribution is based on `argtable3`.

At the highest level, we build an array of pointers where each element in the array points to a description of a recognizable flag/option. This array is called the `argtable` and is what gives this library its name.

The declaration of the `argtable` is:

```
void *argtable[];
```

Each member of the `argtable` is a pointer to one of:

- `arg_lit` – A literal/flag parameter.
- `arg_int` – An integer valued parameter.
- `arg_dbl` – A double valued parameter.
- `arg_str` – A string valued parameter.
- `arg_rex` – A regular expression valued parameter.
- `arg_date` – A date valued parameter.
- `arg_file` – A file valued parameter.
- `arg_end` – The end of parameters marker.

The command line is expected to have been pre-processed into an `argc/argv` format meaning we have an array of strings. To parse the command line, we call:

```
nerrors = arg_parse(argc, argv, argtable);
```

See also:

- [argtable.org](http://argtable.org)
- [Advanced argtable-2.x topics](#)

### **arg\_lit0**

Match 0 or 1 instance of this literal parameter.

```
struct arg_lit* arg_lit0(  
    const char* shortopts,  
    const char* longopts,  
    const char* glossary)
```

Includes:

- `#include <argtable3/argtable3.h>`

### **arg\_lit1**

Match exactly 1 instance of this literal parameter.

```
struct arg_lit* arg_lit1(  
    const char* shortopts,  
    const char* longopts,  
    const char* glossary)
```

Includes:

- `#include <argtable3/argtable3.h>`

### **arg\_litn**

Match some number of instances of this literal parameter.

```
struct arg_lit* arg_litn(  
    const char* shortopts,  
    const char* longopts,  
    int         mincount,  
    int         maxcount,  
    const char* glossary)
```

Includes:

- `#include <argtable3/argtable3.h>`

### **arg\_key0**

```
struct arg_key* arg_key0(  
    const char* keyword,  
    int         flags,  
    const char* glossary)
```

Includes:

- `#include <argtable3/argtable3.h>`

### **arg\_key1**

```
struct arg_key* arg_key1(  
    const char* keyword,  
    int         flags,  
    const char* glossary)
```

Includes:

- `#include <argtable3/argtable3.h>`

### **arg\_keyn**

```
struct arg_key* arg_keyn(  
    const char* keyword,  
    int         flags,  
    int         mincount,  
    int         maxcount,  
    const char* glossary)
```

Includes:

- `#include <argtable3/argtable3.h>`

### **arg\_int0**

Match 0 or 1 instances of this integer parameter

```
struct arg_int* arg_int0(  
    const char* shortopts,  
    const char* longopts,  
    const char* datatype,  
    const char* glossary)
```

An integer can be decimal (123), hexadecimal (0xabcd), octal (0o123) or binary (0b1010). It can also be suffixed by "KB", "MB" or "GB".

The `arg_int` structure contains:

- `count` – The number of integers seen.
- `ival` – An array of integers.

Includes:

- `#include <argtable3/argtable3.h>`

### **arg\_int1**

Match exactly 1 instance of this integer parameter.

```
struct arg_int* arg_int1(  
    const char* shortopts,  
    const char* longopts,  
    const char* datatype,  
    const char* glossary)
```

An integer can be decimal (123), hexadecimal (0xabcd), octal (0o123) or binary (0b1010). It can also be suffixed by "KB", "MB" or "GB".

The `arg_int` structure contains:

- `count` – The number of integers seen.
- `ival` – An array of integers.

Includes:

- `#include <argtable3/argtable3.h>`

## arg\_intn

Match some number of instances of this integer parameter.

```
struct arg_int* arg_intn(  
    const char* shortopts,  
    const char* longopts,  
    const char *datatype,  
    int         mincount,  
    int         maxcount,  
    const char* glossary)
```

An integer can be decimal (123), hexadecimal (0xabcd), octal (0o123) or binary (0b1010). It can also be suffixed by "KB", "MB" or "GB".

The `arg_int` structure contains:

- `count` – The number of integers seen.
- `ival` – An array of integers.

Includes:

- `#include <argtable3/argtable3.h>`

## arg\_dbl0

Match 0 or 1 instances of this double parameter

```
struct arg_dbl* arg_dbl0(  
    const char* shortopts,  
    const char* longopts,  
    const char* datatype,  
    const char* glossary)
```

The `arg_dbl` structure contains:

- `count` – The number of doubles seen.
- `dval` – An array of doubles.

Includes:

- `#include <argtable3/argtable3.h>`

## arg\_dbl1

Match exactly 1 instance of this double parameter.

```
struct arg_dbl* arg_dbl1(  
    const char* shortopts,  
    const char* longopts,
```

```
const char* datatype,  
const char* glossary)
```

The `arg_dbl` structure contains:

- `count` – The number of doubles seen.
- `dval` – An array of doubles.

Includes:

- `#include <argtable3/argtable3.h>`

### **arg\_dbln**

Match some number of instances of this double parameter.

```
struct arg_dbl* arg_dbln(  
    const char* shortopts,  
    const char* longopts,  
    const char* datatype,  
    int         mincount,  
    int         maxcount,  
    const char* glossary)
```

The `arg_dbl` structure contains:

- `count` – The number of doubles seen.
- `dval` – An array of doubles.

Includes:

- `#include <argtable3/argtable3.h>`

### **arg\_str0**

Match 0 or 1 instances of this string parameter

```
struct arg_str* arg_str0(  
    const char* shortopts,  
    const char* longopts,  
    const char* datatype,  
    const char* glossary)
```

The `arg_str` structure contains:

- `count` – The number of strings seen.
- `sval` – An array of strings.

Includes:

- `#include <argtable3/argtable3.h>`



## arg\_str1

Match exactly 1 instance of this string parameter.

```
struct arg_str* arg_str1(  
    const char* shortopts,  
    const char* longopts,  
    const char* datatype,  
    const char* glossary)
```

The `arg_str` structure contains:

- `count` – The number of strings seen.
- `sval` – An array of strings.

Includes:

- `#include <argtable3/argtable3.h>`

## arg\_strn

Match some number of instances of this string parameter.

```
struct arg_str* arg_strn(  
    const char* shortopts,  
    const char* longopts,  
    const char* datatype,  
    int         mincount,  
    int         maxcount,  
    const char* glossary)
```

The `arg_str` structure contains:

- `count` – The number of strings seen.
- `sval` – An array of strings.

Includes:

- `#include <argtable3/argtable3.h>`

## arg\_rex0

Match 0 or 1 instances of this regular expression parameter.

```
struct arg_rex* arg_rex0(  
    const char* shortopts,  
    const char* longopts,
```

```
const char* pattern,  
const char* datatype,  
int        flags,  
const char* glossary)
```

The flags include:

- REG\_ICASE – Ignore case.
- REG\_EXTENDED – Use extended regular expressions.

Includes:

- #include <argtable3/argtable3.h>

### arg\_rex1

Match exactly 1 instance of this regular expression parameter.

```
struct arg_rex* arg_rex1(  
    const char* shortopts,  
    const char* longopts,  
    const char* pattern,  
    const char* datatype,  
    int        flags,  
    const char* glossary)
```

The flags include:

- REG\_ICASE – Ignore case.
- REG\_EXTENDED – Use extended regular expressions.

Includes:

- #include <argtable3/argtable3.h>

### arg\_rexn

Match some number of instances of this regular expression parameter.

```
struct arg_rex* arg_rexn(  
    const char* shortopts,  
    const char* longopts,  
    const char* pattern,  
    const char* datatype,  
    int        mincount,  
    int        maxcount,  
    int        flags,  
    const char* glossary)
```

The flags include:

- REG\_ICASE – Ignore case.

- `REG_EXTENDED` – Use extended regular expressions.

Includes:

- `#include <argtable3/argtable3.h>`

### **arg\_file0**

Match 0 or 1 instances of this file parameter.

```
struct arg_file* arg_file0(  
    const char* shortopts,  
    const char* longopts,  
    const char* datatype,  
    const char* glossary)
```

The `arg_file` structure contains:

- `count` – The number of files seen.
- `filename` – The file name of the file (eg. `/home/kolban/foo.bar`).
- `basename` – The base name of the file (eg. `foo.bar`).
- `extension` – The extension of the file (eg. `.bar`).

Includes:

- `#include <argtable3/argtable3.h>`

### **arg\_file1**

Match exactly 1 instance of this file parameter.

```
struct arg_file* arg_file1(  
    const char* shortopts,  
    const char* longopts,  
    const char* datatype,  
    const char* glossary)
```

The `arg_file` structure contains:

- `count` – The number of files seen.
- `filename` – The file name of the file (eg. `/home/kolban/foo.bar`).
- `basename` – The base name of the file (eg. `foo.bar`).
- `extension` – The extension of the file (eg. `.bar`).

Includes:

- `#include <argtable3/argtable3.h>`

## **arg\_filen**

Match some number of instances of this file parameter.

```
struct arg_file* arg_filen(  
    const char* shortopts,  
    const char* longopts,  
    const char* datatype,  
    int         mincount,  
    int maxcount,  
    const char* glossary)
```

The `arg_file` structure contains:

- `count` – The number of files seen.
- `filename` – The file name of the file (eg. `/home/kolban/foo.bar`).
- `basename` – The base name of the file (eg. `foo.bar`).
- `extension` – The extension of the file (eg. `.bar`).

Includes:

- `#include <argtable3/argtable3.h>`

## **arg\_date0**

Match 0 or 1 instances of this date parameter.

```
struct arg_date* arg_date0(  
    const char* shortopts,  
    const char* longopts,  
    const char* format,  
    const char* datatype,  
    const char* glossary)
```

Includes:

- `#include <argtable3/argtable3.h>`

## **arg\_date1**

Match exactly 1 instance of this date parameter.

```
struct arg_date* arg_date1(  
    const char* shortopts,  
    const char* longopts,  
    const char* format,
```

```
const char* datatype,  
const char* glossary)
```

Includes:

- `#include <argtable3/argtable3.h>`

### **arg\_datan**

Match some number of instances of this date parameter.

```
struct arg_date* arg_datan(  
    const char* shortopts,  
    const char* longopts,  
    const char* format,  
    const char* datatype,  
    int         mincount,  
    int         maxcount,  
    const char* glossary)
```

Includes:

- `#include <argtable3/argtable3.h>`

### **arg\_end**

Mark the end of the parameters in the arg table.

```
struct arg_end* arg_end(int maxerrors)
```

The `arg_end` structure contains:

- `count` – The number of errors encountered..
- `error` – An array of error codes.
- `parent` – An array of pointers to arg structures.
- `argval` – An array of pointers into the argv string.

Includes:

- `#include <argtable3/argtable3.h>`

### **arg\_nullcheck**

Validate that the argtable is good.

```
int arg_nullcheck(void** argtable)
```

Check for nulls in the `argtable`.

Includes:

- `#include <argtable3/argtable3.h>`

### **arg\_parse**

Parse an `argc/argv` pair against the supplied `argtable`.

```
int arg_parse(int argc, char** argv, void** argtable)
```

The return value is the number of errors found.

Remember that `argv[0]` is the name of the program and the parameters start at `argv[1]`.

Includes:

- `#include <argtable3/argtable3.h>`

### **arg\_print\_option**

```
void arg_print_option(  
    FILE* fp,  
    const char* shortopts,  
    const char* longopts,  
    const char* datatype,  
    const char* suffix)
```

Includes:

- `#include <argtable3/argtable3.h>`

### **arg\_print\_syntax**

```
void arg_print_syntax(  
    FILE* fp,  
    void** argtable,  
    const char* suffix)
```

Includes:

- `#include <argtable3/argtable3.h>`

### **arg\_print\_syntaxv**

```
void arg_print_syntaxv(  
    FILE* fp,
```

```
void**      argtable,  
const char* suffix)
```

Includes:

- `#include <argtable3/argtable3.h>`

### **arg\_print\_glossary**

```
void arg_print_glossary(  
FILE*      fp,  
void**     argtable,  
const char* format)
```

Includes:

- `#include <argtable3/argtable3.h>`

### **arg\_print\_glossary\_gnu**

```
void arg_print_glossary_gnu(  
FILE* fp,  
void** argtable)
```

Includes:

- `#include <argtable3/argtable3.h>`

### **arg\_print\_errors**

```
void arg_print_errors(  
FILE*      fp,  
struct arg_end* end,  
const char* progname)
```

Includes:

- `#include <argtable3/argtable3.h>`

### **arg\_free**

```
void arg_free(void **argtable)
```

### **arg\_freetable**

Release the storage of the given argtable.

```
void arg_freetable(void** argtable, size_t n)
```

- The argtable of data.
- The number of entries in the argtable.

Includes:

- `#include <argtable3/argtable3.h>`

### **arg\_print\_formatted**

```
void arg_print_formatted(
    FILE*      fp,
    const unsigned lmargin,
    const unsigned rmargin,
    const char* text)
```

Includes:

- `#include <argtable3/argtable3.h>`

## **JSON processing**

The ESP-IDF provides a C implementation of JSON processing through the ESP-IDF component called "json".

Note: There is a second JSON parsing option called "jsmn" which uses an alternate technique that exchanges minimalism for efficiency.

We can parse a JSON string using `cJSON_Parse()`. This will return a `cJSON` data structure. This data structure exposes:

- `valueint` – The number value as an integer.
- `valuedouble` – The number value as a double.
- `valuestring` – The string value.

To serialize a JSON object to a string representation we can call `cJSON_Print()`.

The complete list of functions are:

- `cJSON_Parse` – Parse a JSON string.
  - `cJSON* cJSON_Parse(const char *value)`
- `cJSON_Print`
- `cJSON_PrintUnformatted`
- `cJSON_PrintBuffered`
- `cJSON_PrintPreallocated`



- cJSON\_Delete
- cJSON\_GetArraySize
- cJSON\_GetArrayItem
- cJSON\_GetObjectItem
- cJSON\_GetErrorPtr
- cJSON\_CreateArray
- cJSON\_CreateBool
- cJSON\_CreateDoubleArray
- cJSON\_CreateFalse
- cJSON\_CreateFloatArray
- cJSON\_CreateIntArray
- cJSON\_CreateObject
- cJSON\_CreateNull
- cJSON\_CreateNumber
- cJSON\_CreateString
- cJSON\_CreateStringArray
- cJSON\_CreateTrue
- cJSON\_AddItemToArray
- cJSON\_AddItemToObject
- cJSON\_AddItemToObjectCS
- cJSON\_AddItemReferenceToArray
- cJSON\_AddItemReferenceToObject
- cJSON\_DetachItemFromArray
- cJSON\_DeleteItemFromArray
- cJSON\_DetachItemFromObject
- cJSON\_DeleteItemFromObject
- cJSON\_InsertItemInArray
- cJSON\_ReplaceItemInArray

- `cJSON_ReplacItemInObject`
- `cJSON_Duplicate`
- `cJSON_Minify`
- `cJSON_AddNullToObject`
- `cJSON_AddTrueToObject`
- `cJSON_AddFalseToObject`
- `cJSON_AddBoolToObject`
- `cJSON_AddNumberToObject`
- `cJSON_AddStringToObject`
- `cJSON_ArrayForEach`
  - A macro which generates a loop over each of the elements.
- `cJSON_SetIntValue`
- `cJSON_SetNumberValue`
- `cJSON_IsInvalid`
- `cJSON_IsFalse`
- `cJSON_IsTrue`
- `cJSON_IsBool`
- `cJSON_IsNull`
- `cJSON_IsNumber`
- `cJSON_IsString`
- `cJSON_IsArray`
- `cJSON_IsRaw`

On an error with a parse, the `cJSON_Parse()` functions returns NULL. We can find the error position by calling `cJSON_GetErrorPtr()` which will return us a pointer into the original raw JSON indicating where the error was detected.

Includes:

- `#include <cJSON.h>`

See also:

- [Github: DaveGamble/cJSON](#)
- [JSMN](#)
- [JSON.org](#)

- [Jansson](#)

## HTTP/2 processing

The ESP-IDF provides an implementation of HTTP/2 parsing through "nghttp2".

See also:

- [HTTP/2 C library and tools – nghttp2.org](#)

## Parsing XML - expat

The ESP-IDF provides a version of expat which is an XML parsing library.

See also:

- [Expat home page](#)
- [Using Expat](#)
- [Expat reference document](#)

## Miniz

Compression is the idea that we can take a chunk of data and compress it into a smaller size such that it can be decompressed back to its original form at a later time. The act of compressing data and then decompressing it must be lossless. This means that the decompressed data must be identical to the original data. Compression is also referred to as deflation and de-compression is referred to as inflation. If we think of a balloon, it may be of a given size. If we deflate it by letting the air out and then inflate it again, we can end up with the same balloon at the end even though in the middle, its volume was only a fraction.

An open source project called Miniz provides deflation and inflation capabilities. The format of the deflated data conforms to the ZLIB standard. A small portion of the Miniz project is included in the ESP32 ROM. While the full header files for the project is present, only the following functions are available for linking:

- `tdefl_compress`
- `tdefl_compress_buffer`
- `tdefl_compress_mem_to_mem`
- `tdefl_compress_mem_to_output`

- `tdefl_get_adler32`
- `tdefl_get_prev_return_status`
- `tdefl_init`
- `tdefl_write_image_to_png_file_in_memory`
- `tdefl_write_image_to_png_file_in_memory_ex`
- `tinfl_decompress`
- `tinfl_decompress_mem_to_callback`
- `tinfl_decompress_mem_to_mem`

A sample using miniz can be found [here](#).

See also:

- [Github: richgel999/miniz](#)
- [RFC1950 – ZLIB Compressed Data Format Specification](#)
- [RFC1951 – DEFLATE Compressed Data Format Specification](#)

### **mz\_free**

Not included in ROM.

```
void mz_free(void *p)
```

### **mz\_adler32**

Not included in ROM.

```
mz_ulong mz_adler32(mz_ulong adler, const unsigned char *ptr, size_t buf_len)
```

### **mz\_crc32**

Not included in ROM.

```
mz_ulong mz_crc32(mz_ulong crc, const unsigned char *ptr, size_t buf_len)
```

### **mz\_version**

Not included in ROM.

```
const char *mz_version(void)
```

### **mz\_deflateInit**

Not included in ROM.

```
int mz_deflateInit(mz_stream *pStream, int level)
```

### **mz\_deflateInit2**

Not included in ROM.

```
int mz_deflateInit2(mz_stream pStream, int level, int method, int window_bits, int mem_level, int strategy)
```

### **mz\_deflateReset**

Not included in ROM.

```
int mz_deflateReset(mz_stream pStream)
```

### **mz\_deflate**

Not included in ROM.

```
int mz_deflate(mz_stream pStream, int flush)
```

### **mz\_deflateEnd**

Not included in ROM.

```
int mz_deflateEnd(mz_stream pStream)
```

### **mz\_deflateBound**

Not included in ROM.

```
mz_ulong mz_deflateBound(mz_stream pStream, mz_ulong source_len)
```

### **mz\_compressBound**

Not included in ROM.

```
mz_ulong mz_compressBound(mz_ulong source_len)
```

### **mz\_inflateInit**

Not included in ROM.

```
int mz_inflateInit(mz_stream pStream)
```

### **mz\_inflateInit2**

Not included in ROM.

```
int mz_inflateInit2(mz_stream pStream, int window_bits)
```

### **mz\_inflateEnd**

Not included in ROM.

```
int mz_inflateEnd(mz_stream pStream)
```

### **mz\_uncompress**

Not included in ROM.

```
int mz_uncompress(unsigned char *pDest, mz_ulong *pDest_len, const unsigned char *pSource, mz_ulong source_len)
```

### **mz\_error**

Not included in ROM.

```
const char *mz_error(int err)
```

### **mz\_zip\_reader\_init**

Not included in ROM.

```
mz_bool mz_zip_reader_init(mz_zip_archive *pZip, mz_uint64 size, mz_uint32 flags)
```

### **mz\_zip\_reader\_init\_mem**

Not included in ROM.

```
mz_bool mz_zip_reader_init_mem(mz_zip_archive *pZip, const void *pMem, size_t size, mz_uint32 flags)
```

### **mz\_zip\_reader\_get\_num\_files**

Not included in ROM.

```
mz_uint mz_zip_reader_get_num_files(mz_zip_archive *pZip)
```

### **mz\_zip\_reader\_file\_stat**

Not included in ROM.

```
mz_bool mz_zip_reader_file_stat(mz_zip_archive *pZip, mz_uint file_index, mz_zip_archive_file_stat *pStat)
```

### **mz\_zip\_reader\_is\_file\_a\_directory**

Not included in ROM.

```
mz_bool mz_zip_reader_is_file_a_directory(mz_zip_archive *pZip, mz_uint file_index)
```

### **mz\_zip\_reader\_is\_file\_encrypted**

Not included in ROM.

```
mz_bool mz_zip_reader_is_file_encrypted(mz_zip_archive *pZip, mz_uint file_index)
```

### **mz\_zip\_reader\_get\_filename**

Not included in ROM.

```
mz_uint mz_zip_reader_get_filename(mz_zip_archive *pZip, mz_uint file_index, char *pFilename, mz_uint filename_buf_size)
```

### **mz\_zip\_reader\_locate\_file**

Not included in ROM.

```
int mz_zip_reader_locate_file(mz_zip_archive *pZip, const char *pName, const char *pComment, mz_uint flags)
```

### **mz\_zip\_reader\_extract\_to\_mem\_no\_alloc**

Not included in ROM.

```
mz_bool mz_zip_reader_extract_to_mem_no_alloc(mz_zip_archive *pZip, mz_uint
file_index, void *pBuf, size_t buf_size, mz_uint flags, void *pUser_read_buf, size_t
user_read_buf_size)
```

### **mz\_zip\_reader\_extract\_file\_to\_mem\_no\_alloc**

Not included in ROM.

```
mz_bool mz_zip_reader_extract_file_to_mem_no_alloc(mz_zip_archive *pZip, const char
*pFilename, void *pBuf, size_t buf_size, mz_uint flags, void *pUser_read_buf, size_t
user_read_buf_size)
```

### **mz\_zip\_reader\_extract\_to\_mem**

Not included in ROM.

```
mz_bool mz_zip_reader_extract_to_mem(mz_zip_archive *pZip, mz_uint file_index, void
*pBuf, size_t buf_size, mz_uint flags)
```

### **mz\_zip\_reader\_extract\_file\_to\_mem**

Not included in ROM.

```
mz_bool mz_zip_reader_extract_file_to_mem(mz_zip_archive *pZip, const char *pFilename,
void *pBuf, size_t buf_size, mz_uint flags)
```

### **mz\_zip\_reader\_extract\_to\_heap**

Not included in ROM.

```
void *mz_zip_reader_extract_to_heap(mz_zip_archive *pZip, mz_uint file_index, size_t
*pSize, mz_uint flags)
```

### **mz\_zip\_reader\_extract\_file\_to\_heap**

Not included in ROM.

```
void *mz_zip_reader_extract_file_to_heap(mz_zip_archive *pZip, const char *pFilename,
size_t *pSize, mz_uint flags)
```

### **mz\_zip\_reader\_extract\_to\_callback**

Not included in ROM.

```
mz_bool mz_zip_reader_extract_to_callback(mz_zip_archive *pZip, mz_uint file_index,
mz_file_write_func pCallback, void *pOpaque, mz_uint flags)
```

### **mz\_zip\_reader\_extract\_file\_to\_callback**

Not included in ROM.

```
mz_bool mz_zip_reader_extract_file_to_callback(mz_zip_archive *pZip, const char
*pFilename, mz_file_write_func pCallback, void *pOpaque, mz_uint flags)
```

### **mz\_zip\_reader\_extract\_to\_file**

Not included in ROM.

```
mz_bool mz_zip_reader_extract_to_file(mz_zip_archive *pZip, mz_uint file_index, const char *pDst_filename, mz_uint flags)
```

### **mz\_zip\_reader\_extract\_file\_to\_file**

Not included in ROM.

```
mz_bool mz_zip_reader_extract_file_to_file(mz_zip_archive *pZip, const char *pArchive_filename, const char *pDst_filename, mz_uint flags)
```

### **mz\_zip\_reader\_end**

Not included in ROM.

```
mz_bool mz_zip_reader_end(mz_zip_archive *pZip)
```

### **mz\_zip\_writer\_init**

Not included in ROM.

```
mz_bool mz_zip_writer_init(mz_zip_archive *pZip, mz_uint64 existing_size)
```

### **mz\_zip\_writer\_init\_heap**

Not included in ROM.

```
mz_bool mz_zip_writer_init_heap(mz_zip_archive *pZip, size_t size_to_reserve_at_beginning, size_t initial_allocation_size)
```

### **mz\_zip\_writer\_init\_file**

Not included in ROM.

```
mz_bool mz_zip_writer_init_file(mz_zip_archive *pZip, const char *pFilename, mz_uint64 size_to_reserve_at_beginning)
```

### **mz\_zip\_writer\_init\_from\_reader**

Not included in ROM.

```
mz_bool mz_zip_writer_init_from_reader(mz_zip_archive *pZip, const char *pFilename)
```

### **mz\_zip\_writer\_add\_mem**

Not included in ROM.

```
mz_bool mz_zip_writer_add_mem(mz_zip_archive *pZip, const char *pArchive_name, const void *pBuf, size_t buf_size, mz_uint level_and_flags)
```

### **mz\_zip\_writer\_add\_mem\_ex**

Not included in ROM.

```
mz_bool mz_zip_writer_add_mem_ex(mz_zip_archive *pZip, const char *pArchive_name, const void *pBuf, size_t buf_size, const void *pComment, mz_uint16 comment_size, mz_uint level_and_flags, mz_uint64 uncompress_size, mz_uint32 uncompress_crc32)
```



### **mz\_zip\_writer\_add\_file**

Not included in ROM.

```
mz_bool mz_zip_writer_add_file(mz_zip_archive *pZip, const char *pArchive_name, const
char *pSrc_filename, const void *pComment, mz_uint16 comment_size, mz_uint
level_and_flags)
```

### **mz\_zip\_writer\_add\_from\_zip\_reader**

Not included in ROM.

```
mz_bool mz_zip_writer_add_from_zip_reader(mz_zip_archive *pZip, mz_zip_archive
*pSource_zip, mz_uint file_index)
```

### **mz\_zip\_writer\_finalize\_archive**

Not included in ROM.

```
mz_bool mz_zip_writer_finalize_archive(mz_zip_archive *pZip)
```

### **mz\_zip\_writer\_finalize\_heap\_archive**

Not included in ROM.

```
mz_bool mz_zip_writer_finalize_heap_archive(mz_zip_archive *pZip, void **pBuf, size_t
*pSize)
```

### **mz\_zip\_writer\_end**

Not included in ROM.

```
mz_bool mz_zip_writer_end(mz_zip_archive *pZip)
```

### **mz\_zip\_add\_mem\_to\_archive\_file\_in\_place**

Not included in ROM.

```
mz_bool mz_zip_add_mem_to_archive_file_in_place(const char *pZip_filename, const char
*pArchive_name, const void *pBuf, size_t buf_size, const void *pComment, mz_uint16
comment_size, mz_uint level_and_flags)
```

### **mz\_zip\_extract\_archive\_file\_to\_heap**

Not included in ROM.

```
void *mz_zip_extract_archive_file_to_heap(const char *pZip_filename, const char
*pArchive_name, size_t *pSize, mz_uint zip_flags)
```

### **tinfl\_decompress**

This function is present in ROM.

```
tinfl_status tinfl_decompress(
    tinfl_decompressor* decomp,
    const mz_uint8*      pIn_buf_next,
    size_t*              pIn_buf_size,
    mz_uint8*           pOut_buf_start,
```

```
mz_uint8*      pOut_buf_next,  
size_t*       pOut_buf_size,  
const mz_uint32  decomp_flags)
```

- `decomp` – The decompressor data that was initialized by previously called `tinfl_init()`.
- `pIn_buf_next` – The next piece of input to inflate.
- `pIn_buf_size` – The size of the available data to inflate. On return, the number of bytes processed. This may be less than the number of bytes provided.
- `pOut_buf_start` – The initial output buffer. This is a buffer big enough to hold a chunk of data, usually 32K.
- `pOut_buf_next` – Subsequent output buffer. This the next place in the buffer pointed to by `pOut_buf_start` where the next part of the data will be written.
- `pOut_buf_size` – Size of decoded data that is decoded in *this* execution.
- `decomp_flags` – Decompression (inflation) flags:
  - `TINFL_FLAG_PARSE_ZLIB_HEADER` – If set, the data contains ZLIB otherwise it is pure DEFLATE data.
  - `TINFL_FLAG_HAS_MORE_INPUT` – If set, there is more input to come. If clear, the input buffer contains all the remaining input.
  - `TINFL_FLAG_USING_NON_WRAPPING_OUTPUT_BUF` – If set, the output buffer is large enough to hold the entire decompressed stream. If not buffer must be at least large enough to hold the dictionary (about 32K).
  - `TINFL_FLAG_COMPUTE_ADLER32` – Perform an Adler32 checksum of the decompressed data.

The return is a status code of:

- `TINFL_STATUS_BAD_PARAM`
- `TINFL_STATUS_ADLER32_MISMATCH`
- `TINFL_STATUS_FAILED`
- `TINFL_STATUS_DONE`
- `TINFL_STATUS_NEEDS_MORE_INPUT`
- `TINFL_STATUS_HAS_MORE_OUTPUT`

Algorithm:

```
outputBufferNext = outputBuffer;  
remainingInput = size of input;  
while (remainingInput) {
```

```

inputSize = remainingInput;
outSize = outputBuffer + sizeof(outputBuffer) - outputBufferNext;
status = tinfl_decompress(
    ...
    inputBuffer,
    &inputSize,
    outputBuffer,
    outputBufferNext,
    &outSize, flags);
if (status == BAD_PARAM || status == ADLER32_MISMATCH || status == FAILED) {
    break;
}
outputBufferNext = outputBufferNext + outSize;
if (status == DONE || outputBufferNext == outputBuffer + sizeof(outputBuffer)) {
    process output buffer;
    if (status == DONE) {
        break;
    }
    outputBufferNext = outputBuffer;
}
remainingInput = remainingInput - inputSize;
if (remainingInput == 0) {
    get more input, save in inputBuffer;
    remainingInput = size of new input;
}
}

```

### **tinfl\_decompress\_mem\_to\_heap**

Not included in ROM.

```

void *tinfl_decompress_mem_to_heap(const void *pSrc_buf, size_t src_buf_len, size_t
*pOut_len, int flags)

```

### **tinfl\_decompress\_mem\_to\_mem**

This function is present in ROM.

```

size_t tinfl_decompress_mem_to_mem(
    void*      pOut_buf,
    size_t     out_buf_len,
    const void* pSrc_buf,
    size_t     src_buf_len,
    int        flags)

```

### **tinfl\_decompress\_mem\_to\_callback**

This function is present in ROM.

```

int tinfl_decompress_mem_to_callback(
    const void*      pIn_buf,
    size_t*          pIn_buf_size,
    tinfl_put_buf_func_ptr pPut_buf_func,

```

```
void*          pPut_buf_user,  
int           flags)
```

### **tinfl\_init**

This function is present in ROM.

```
tinfl_init(tinfl_decompressor *decomp)
```

### **tinfl\_get\_adler32**

Not included in ROM.

```
tinfl_get_adler32(r)
```

### **tdefl\_compress\_mem\_to\_heap**

Not included in ROM.

```
void *tdefl_compress_mem_to_heap(  
    const void* pSrc_buf,  
    size_t      src_buf_len,  
    size_t*     pOut_len,  
    int         flags)
```

### **tdefl\_compress\_mem\_to\_mem**

This function is present in ROM.

```
size_t tdefl_compress_mem_to_mem(  
    void*       pOut_buf,  
    size_t      out_buf_len,  
    const void* pSrc_buf,  
    size_t      src_buf_len,  
    int         flags)
```

### **tdefl\_write\_image\_to\_png\_file\_in\_memory\_ex**

This function is present in ROM.

```
void *tdefl_write_image_to_png_file_in_memory_ex(  
    const void* pImage,  
    int         w,  
    int         h,  
    int         num_chans,  
    size_t*     pLen_out,  
    mz_uint     level,  
    mz_bool     flip)
```

### **tdefl\_write\_image\_to\_png\_file\_in\_memory**

This function is present in ROM.

```
void *tdefl_write_image_to_png_file_in_memory(  
    const void* pImage,  
    int         w,  
    int         h,
```

```
int          num_chans,  
size_t*     pLen_out)
```

### **tdefl\_compress\_mem\_to\_output**

This function is present in ROM.

```
mz_bool tdefl_compress_mem_to_output(  
const void*      pBuf,  
size_t          buf_len,  
tdefl_put_buf_func_ptr pPut_buf_func,  
void*           pPut_buf_user,  
int             flags)
```

### **tdefl\_init**

Initialize the compressor.

This function is present in ROM.

```
tdefl_status tdefl_init(  
tdefl_compressor* d,  
tdefl_put_buf_func_ptr pPut_buf_func,  
void*           pPut_buf_user,  
int             flags)
```

- d
- pPut\_buf\_func
- pPut\_buf\_user
- flags
  - TDEFL\_HUFFMAN\_ONLY
  - TDEFL\_DEFAULT\_MAX\_PROBES
  - TDEFL\_WRITE\_ZLIB\_HEADER
  - TDEFL\_COMPUTE\_ADLER32
  - TDEFL\_GREEDY\_PARSING\_FLAG
  - TDEFL\_NONDETERMINISTIC\_PARSING\_FLAG
  - TDEFL\_RLE\_MATCHES
  - TDEFL\_FILTER\_MATCHES
  - TDEFL\_FORCE\_ALL\_STATIC\_BLOCKS
  - TDEFL\_FORCE\_ALL\_RAW\_BLOCKS

## **tdefl\_compress**

This function is present in ROM.

```
tdefl_status tdefl_compress(  
    tdefl_compressor* d,  
    const void*      pIn_buf,  
    size_t*          pIn_buf_size,  
    void*            pOut_buf,  
    size_t*          pOut_buf_size,  
    tdefl_flush      flush)
```

## **tdefl\_compress\_buffer**

This function is present in ROM.

```
tdefl_status tdefl_compress_buffer(  
    tdefl_compressor* d,  
    const void*      pIn_buf,  
    size_t           in_buf_size,  
    tdefl_flush      flush)
```

## **tdefl\_get\_prev\_return\_status**

This function is present in ROM.

```
tdefl_status tdefl_get_prev_return_status(tdefl_compressor *d)
```

## **tdefl\_get\_adler32**

This function is present in ROM.

```
mz_uint32 tdefl_get_adler32(tdefl_compressor *d)
```

## **tdefl\_create\_comp\_flags\_from\_zip\_params**

Not included in ROM.

```
mz_uint tdefl_create_comp_flags_from_zip_params(  
    int level,  
    int window_bits,  
    int strategy)
```

## **Arduino - ESP32 HAL for UART**

### **uartAvailable**

```
uint32_t uartAvailable(uart_t *uart)
```

Includes:

- `#include <esp32-hal-uart.h>`

## uartBegin

Initialize a UART for work.

```
uart_t *uartBegin(  
    uint8_t uartNumber,  
    uint32_t baudrate,  
    uint32_t config,  
    int8_t rxPin,  
    int8_t txPin,  
    uint16_t queueLen,  
    bool inverted)
```

The `uartNumber` can be one of the three UARTs on the device. They are numbered 0, 1 and 2. The `rxPin` is the pin used for receiving incoming data, The `txPin` is the pin used to transmit data. If -1 is specified, then the UART is input or output only. It is invalid to specify -1 for both pins (i.e. a uart with neither input nor output). The config parameter is the configuration for the UART. A configuration is broken into three parameters:

- Number of bits – 5,6,7 or 8
- Parity checking – None, Even or Odd
- Number of stop bits – 1 or 2

Constants are defined for all possibilities in the form:

```
SERIAL_<NUMBER OF BITS><PARITY><NUMBER OF STOP BITS>
```

For example:

```
SERIAL_8N1
```

Means 8 bits, no parity check, 1 stop bit.

Includes:

- `esp32-hal-uart.h`

See also:

- `uartEnd`

## uartEnd

Release resources associated with the uart.

```
void uartEnd(uart_t *uart)
```

Includes:

- `esp32-hal-uart.h`

See also:

- `uartBegin`

### **uartFlush**

```
void uartFlush(uart_t *uart)
```

Includes:

- `esp32-hal-uart.h`

### **uartGetBaudRate**

Get the current baud rate of the uart.

```
uint32_t uartGetBaudRate(uart_t *uart)
```

Includes:

- `esp32-hal-uart.h`

See also:

- `uartSetBaudRate`
- `uartBegin`

### **uartGetDebug**

```
int uartGetDebug()
```

Includes:

- `esp32-hal-uart.h`

See also:

- `uartSetDebug`

### **uartPeek**

Retrieve the next byte to be read without actually consuming it.

```
uint8_t uartPeek(uart_t *uart)
```

Includes:

- `esp32-hal-uart.h`

See also:

- `uartRead`



## uartRead

Read a byte from the uart.

```
uint8_t uartRead(uart_t *uart)
```

Includes:

- esp32-hal-uart.h

See also:

- uartAvailable
- uartPeek

## uartSetBaudRate

Set the baud rate of the uart.

```
void uartSetBaudRate(uart_t *uart, uint32_t baud_rate)
```

Includes:

- esp32-hal-uart.h
- uartGetBaudRate
- uartBegin

## uartSetDebug

Specify a uart as the target of debug data.

```
void uartSetDebug(uart_t *uart)
```

Includes:

- esp32-hal-uart.h

See also:

- uartGetDebug

## uartWrite

Write a single byte to the uart.

```
void uartWrite(uart_t *uart, uint8_t c)
```

This is a blocking call and waits for the transmission to complete.

Includes:

- esp32-hal-uart.h

## uartWriteBuf

Write a buffer of bytes to the uart.

```
void uartWriteBuf(  
    uart_t *uart,  
    const uint8_t *data,  
    size_t len)
```

Writes the buffer to the uart blocking until completion.

Includes:

- esp32-hal-uart.h

## Arduino - ESP32 HAL for I2C

See also:

- Error: Reference source not found

## i2cAttachSCL

Associate the bus's clock signal with a specific GPIO pin.

```
i2c_err_t i2cAttachSCL(i2c_t *i2c, int8_t scl)
```

## i2cAttachSDA

```
i2c_err_t i2cAttachSDA(i2c_t *i2c, int8_t sda)
```

Associate the bus's data signal with a specific GPIO pin.

## i2cDetachSCL

```
i2c_err_t i2cDetachSCL(i2c_t *i2c, int8_t scl)
```

Disassociate the bus's clock signal with a specific GPIO pin.

## i2cDetachSDA

```
i2c_err_t i2cDetachSDA(i2c_t *i2c, int8_t sda)
```

Disassociate the bus's data signal with a specific GPIO pin.

## i2cGetFrequency

```
uint32_t i2cGetFrequency(i2c_t *i2c)
```

## i2cInit

Initialize access to the I2C bus.

```
i2c_t *i2cInit(  
    uint8_t i2c_num,  
    uint16_t slave_addr,  
    bool addr_10bit_en)
```

The `i2c_num` is the identify of the I2C bus we are planning on using. The `slave_addr` is the address of the slave device we wish to appear as. The `addr_10bit_en` would be set to true if we are using 10 bit slave addressing.

The return from this call is a handle that is passed into other calls to refer to this bus/device.

See also:

- Error: Reference source not found

## i2cRead

Read data from the I2C bus.

```
i2c_err_t i2cRead(  
    i2c_t *i2c,  
    uint16_t address,  
    bool addr_10bit,  
    uint8_t *data,  
    uint8_t len,  
    bool sendStop)
```

The `i2c` is a handle to an I2C bus. The `address` is the address of the device with which we are communicating. The `addr_10bit` is set to true if we are using 10 bit addressing. The `data` is a pointer to a buffer to be filled in by the read. The `len` is the number of bytes to read. The `sendStop` is a flag which indicates whether we should send a stop indication.

## i2cSetFrequency

```
i2c_err_t i2cSetFrequency(i2c_t *i2c, uint32_t clk_speed)
```

## **i2cWrite**

Write data down the I2C bus.

```
i2c_err_t i2cWrite(  
    i2c_t *i2c,  
    uint16_t address,  
    bool addr_10bit,  
    uint8_t *data,  
    uint8_t len,  
    bool sendStop)
```

The `i2c` is a handle to an I2C bus. The `address` is the address of the device with which we are communicating. The `addr_10bit` is set to true if we are using 10 bit addressing. The `data` is a pointer to a buffer of data to be transmitted. The `len` is the size of the data to transmit. The `sendStop` should be true if we are sending a stop flag at the end of the transmission.

## **Arduino - ESP32 HAL for SPI**

See also:

- [The Arduino Hardware Abstraction Layer SPI](#)

## **spiAttachMISO**

Specify the pin to use for MISO.

```
void spiAttachMISO(spi_t *spi, int8_t miso)
```

## **spiAttachMOSI**

Specify the pin to use for MOSI.

```
void spiAttachMOSI(spi_t *spi, int8_t mosi)
```

## **spiAttachSCK**

Specify the pin to use for SCK.

```
void spiAttachSCK(spi_t *spi, int8_t sck)
```

## **spiAttachSS**

Specify the pin to use for SS.

```
void spiAttachSS(spi_t *spi, uint8_t cs_num, int8_t ss)
```

### **spiClockDivToFrequency**

Convert a clock divider to a frequency.

```
uint32_t spiClockDivToFrequency(uint32_t clockDiv)
```

A given clock divider value results in an SPI clock frequency. This function takes a clock divider and returns the frequency that would result from using the divider.

### **spiDetachMISO**

```
void spiDetachMISO(spi_t *spi, int8_t miso)
```

### **spiDetachMOSI**

```
void spiDetachMOSI(spi_t *spi, int8_t mosi)
```

### **spiDetachSCK**

```
void spiDetachSCK(spi_t *spi, int8_t sck)
```

### **spiDetachSS**

Detach the pin from SS.

```
void spiDetachSS(spi_t *spi, int8_t ss)
```

### **spiDisableSSPins**

```
void spiDisableSSPins(spi_t *spi, uint8_t cs_mask)
```

### **spiEnableSSPins**

```
void spiEnableSSPins(spi_t *spi, uint8_t cs_mask)
```

### **spiFrequencyToClockDiv**

Calculate a clock divider needed for a given frequency.

```
uint32_t spiFrequencyToClockDiv(uint32_t freq)
```

Internally, the SPI clock is based on a given clock divider. Commonly, we want to think about SPI clock frequencies. This function calculates the divider necessary to achieve a specific frequency.

### **spiGetBitOrder**

Retrieve the current bit order.

```
uint8_t spiGetBitOrder(spi_t *spi)
```

Retrieve the current bit order being used. It will be one of:

- SPI\_LSBFIRST
- SPI\_MSBFIRST

### **spiGetClockDiv**

Get the underlying clock divider.

```
uint32_t spiGetClockDiv(spi_t *spi)
```

For a given SPI device, get the clock divider. Note that this is **not** the same as the SPI clock frequency.

### **spiGetDataMode**

Retrieve the current data mode.

```
uint8_t spiGetDataMode(spi_t *spi)
```

Retrieve the current data mode of SPI. It should be one of:

- SPI\_MODE0
- SPI\_MODE1
- SPI\_MODE2
- SPI\_MODE3

### **spiRead**

Read a buffer of data through SPI.

```
void spiRead(spi_t *spi, uint32_t *out, uint8_t len)
```

### **spiReadByte**

Read a single byte of data through SPI.

```
uint8_t spiReadByte(spi_t *spi)
```

### **spiReadLong**

Read a 32 bit value (a long) from SPI.

```
uint32_t spiReadLong(spi_t *spi)
```

### **spiReadWord**

Read a 16 bit value (a word) from SPI.

```
uint16_t spiReadWord(spi_t *spi)
```

### **spiSetBitOrder**

Set the bit order.

```
void spiSetBitOrder(spi_t *spi, uint8_t bitOrder)
```

The `bitOrder` should be the bit order to be used. It should be one of:

- `SPI_LSBFIRST`
- `SPI_MSBFIRST`

### **spiSetClockDiv**

Set the clock based on a clock divisor.

```
void spiSetClockDiv(spi_t *spi, uint32_t clockDiv)
```

### **spiSetDataMode**

Set the data mode.

```
void spiSetDataMode(spi_t *spi, uint8_t dataMode)
```

The `dataMode` is the data mode of SPI. It should be one of:

- `SPI_MODE0`
- `SPI_MODE1`
- `SPI_MODE2`

- SPI\_MODE3

### **spiSSClear**

```
void spiSSClear(spi_t *spi)
```

### **spiSSDisable**

```
void spiSSDisable(spi_t *spi)
```

### **spiSSEnable**

```
void spiSSEnable(spi_t *spi)
```

### **spiSSSet**

```
void spiSSSet(spi_t *spi)
```

### **spiStartBus**

Initialize an instance of the bus.

```
spi_t *spiStartBus(  
    uint8_t spi_num,  
    uint32_t freq,  
    uint8_t dataMode,  
    uint8_t bitOrder)
```

Initialize an instance of one of the three buses specifying how it should be driven. The `spi_num` is the identity of one of the three buses. It may be one of:

- FSPI
- HSPI
- VSPI

Note that FSPI is believe to be off-limits for application usage.

The `freq` is the speed of the bus. For example 1000000 for 1MHz. The `dataMode` is the data mode of SPI. It should be one of:

- SPI\_MODE0
- SPI\_MODE1
- SPI\_MODE2



- SPI\_MODE3

The `bitOrder` should be the bit order to be used. It should be one of:

- SPI\_LSBFIRST
- SPI\_MSBFIRST

The return is a reference to an SPI instance.

See also:

- `spiStopBus`

### **spiStopBus**

Release the resources for an SPI bus.

```
void spiStopBus(spi_t *spi)
```

The `spi` is a handle to a bus previously created with a call to `spiStartBus()`.

See also:

- `spiStartBus`

### **spiTransferBits**

Transfer bits over SPI and optionally receive response bits.

```
void spiTransferBits(  
    spi_t *spi,  
    uint32_t sendData,  
    uint32_t *receiveData,  
    uint8_t bits)
```

The `bits` is the number of bits to send. A maximum of 32 bits at one shot. The `sendData` is the data to send, the `receiveData` is a pointer to storage to hold retrieved data. It may be NULL to indicate that we don't want to receive data. The `spi` is the handle of the SPI interface.

See also:

- `spiStartBus`

### **spiTransferBytes**

Write and read data through SPI.

```
void spiTransferBytes(  
    spi_t *spi,  
    uint8_t *sendData,  
    uint8_t *receiveData,  
    uint32_t size)
```

This is the key function in SPI. Here we specify a buffer of data to send through SPI and a buffer of data to read from SPI. If we don't need to send data we can specify NULL for the `sendData` and if we don't need to receive, we can specify NULL for `receiveData`. The `size` is the number of bytes that we are to send and receive.

### **spiWaitReady**

```
void spiWaitReady(spi_t *spi)
```

### **spiWrite**

Write a buffer of data out through SPI.

```
void spiWrite(spi_t *spi, uint32_t *data, uint8_t len)
```

### **spiWriteByte**

Write a single byte of data out through SPI.

```
void spiWriteByte(spi_t *spi, uint8_t data)
```

### **spiWriteLong**

Write a 32 bit value (a long) out through SPI.

```
void spiWriteLong(spi_t *spi, uint32_t data)
```

### **spiWriteWord**

Write a 16 bit value (a word) out through SPI.

```
void spiWriteWord(spi_t *spi, uint16_t data)
```

## **Newlib**

When we think of the C programming language we must realize that is exactly what it is ... a programming language. Functions like "printf" and "strcpy" and "malloc" are not

part of the C language. They are functions commonly provided by the environment in which the compiled program executes. These functions are so prevalent that we assume them just to be there when C programming but the reality is that something has to provide them. On a Unix/Linux environment, it is the kernel and support user level libraries. But what of our ESP32? The answer is an open source library called "newlib". Newlib takes the common specifications for many of the functions that we expect to be there on a C platform and provides an open source implementation of them. Within the ESP32 environment a version of newlib is provided that has been mapped for the ESP32.

From the newlib library, the following functions are exported (and others):

See also:

- [newlib](#)

### **abort**

Results in the abnormal termination of the environment (a halt).

```
void abort()
```

See also:

- [man\(3\) – abort](#)

### **abs**

Compute the absolute (non-negative) value of an integer.

```
int abs(int val)
```

Includes:

- `stdlib.h`

See also:

- [man\(3\) – abs](#)

### **asctime**

Format a struct tm time value into a text string.

```
char *asctime(const struct tm *tm)
char *asctime_r(const struct tm *tm, char *buf)
```

The struct tm contains:

- `tm_sec` – 0-59

- `tm_min` – 0-59
- `tm_hour` – 0-23
- `tm_mday` – 1-31
- `tm_mon` – 0-11
- `tm_year` – Years since 1900 (eg. 2017 = 117)
- `tm_wday` – 0-6
- `tm_yday` – 0-365
- `tm_isdst` – 1/0

The output format is the same as `ctime()`.

See also:

- Timers and time
- [man\(3\) – asctime](#)

## **atoi**

Convert a string to an integer.

```
int atoi(const char *s)
```

See also:

- [man\(3\) – atoi](#)

## **atol**

Convert a string to an integer.

```
long atol(const char *s)
```

See also:

- [man\(3\) – atol](#)

## **bzero**

Zero an area of memory.

```
void bzero(void *s, size_t n)
```

See also:

- [man\(3\) – bzero](#)

## calloc

Allocate an area of storage for a number of fixed size entries.

```
void *calloc(size_t c, size_t n)
```

See also:

- `free`
- `malloc`
- `realloc`
- [man\(3\) – calloc](#)

## check\_pos

## close

Close a file descriptor.

```
int close(int fd)
```

See also:

- [man\(3\) – close](#)

## closedir

Includes:

- `#include <sys/dirent.h>`

## creat

Create a new file.

```
int create(const char *path, mode_t mode)
```

Includes:

- `fcntl.h`

See also:

- [man\(3\) – creat](#)

## ctime

Convert `time_t` data to a string.

```
char *ctime(const time_t *timep)  
char *ctime_r(const time_t *timep, char *buf)
```

The `time_t` can be obtained from a call to `time()`. An example of output would be:

```
Thu Jan 1 00:00:00 1970\n
```

The length of the string is a constant 25 characters (including the newline). This means we can efficiently terminate the line before the newline or just print the first 24 characters if we don't want to print the newline.

Note that a newline is found on the end.

Includes:

- `time.h`

See also:

- Timers and time
- `time`
- [man\(3\) - ctime](#)

## **div**

Compute quotient and remainder.

```
div_t div(int numerator, int denominator)
```

Includes:

- `stdlib.h`

See also:

- [man\(3\) - div](#)

## **environ**

Access environment variables.

```
char **environ
```

Includes:

- `unistd.h`

See also:

- [man\(3\) - environ](#)

## **fclose**

Close a stream.

```
int fclose(FILE *fp)
```

Includes:

- `#include <stdio.h>`

See also:

- [man\(3\)–fclose](#)

## **fflush**

Flush a stream.

```
int fflush(FILE *fp)
```

Includes:

- `#include <stdio.h>`

See also:

- [man\(3\)–fflush](#)

## **fmemopen**

Perform stream I/O on a buffer of memory.

```
FILE *fmemopen(void *buf, size_t size, const char *mode)
```

The return is a FILE pointer that can be used with other stream I/O functions. The mode is the same as found for `fopen()`.

Includes:

- `#include <stdio.h>`

See also:

- [man\(3\)–fmemopen](#)

## **fprintf**

Print to a stream.

```
int printf(const char *format, ...)
```

Includes:

- `#include <stdio.h>`

See also:

- `printf`
- [man\(3\)–fprintf](#)

## fread

Read from the file into a memory area.

```
size_t fread(void *ptr, size_t size, size_t nmemb, FILE *stream)
```

Includes:

- `#include <stdio.h>`

See also:

- [man\(3\) – fread](#)

## free

Free allocated memory.

```
void free(void *p)
```

Releases memory previously allocated by a call to `malloc()`.

Includes:

- `#include <stdlib.h>`

See also:

- `calloc`
- `malloc`
- `realloc`
- [man\(3\) – free](#)

## fscanf

Scan from a stream.

```
int fscanf(FILE *stream, const char *format, ...)
```

Includes:

- `#include <stdio.h>`

See also:

- [man\(3\) – fscanf](#)

## fseek

### fstat

Obtain the stats of an open file.

```
int fstat(int fd, struct stat *buf)
```

See also:



- [man\(2\) – fstat](#)

## **fwrite**

Write data to an output stream.

```
size_t fwrite(const void *ptr, size_t size, size_t nmemb, FILE *stream)
```

Includes:

- `#include <stdio.h>`

See also:

- [man\(3\) – fwrite](#)

## **gettimeofday**

Get the current time.

```
int gettimeofday(struct timeval *tv, struct timezone *tz)
```

Return the current time of day as a struct timeval. This structure contains the following fields:

- `time_t tv_sec` – Seconds since epoch.
- `suseconds_t tv_usec` – Microseconds within current second.

A sample set of C functions is available here [<insert URL>](#) that provides some simple routines for working with struct timeval including:

- `struct timeval timeval_add(struct timeval *a, struct timeval *b)` – Add two time values together.
- `void timeval_addMsecs(struct timeval *a, uint32_t msecs)` – Add milliseconds to time value.
- `uint32_t timeval_durationBeforeNow(struct timeval *a)` – Determine how many milliseconds the supplied time value was in the past.
- `uint32_t timeval_durationFromNow(struct timeval *a)` – Determine how many milliseconds the given future time value will be from now or 0 if it has already passed.
- `struct timeval timeval_sub(struct timeval *a, struct timeval *b)` – Subtract one time value from another. The first parameter should be further along the time line (sooner) than the second (later).

- `uint32_t timeval_toMsecs(struct timeval *a)` – Return the number of milliseconds within the time value.

Includes:

- `#include <sys/time.h>`

See also:

- `settimeofday`
- Timers and time
- [man\(2\) – gettimeofday](#)

## gmtime

Break down a time into its components based on UTC.

```
struct tm *gmtime(const time_t *timep)
struct tm *gmtime_r(const time_t *timep, struct tm *result)
```

The `time_t` value can be obtained from a call to `time()`.

Includes:

- `#include <time.h>`

See also:

- Timers and time
- `time`
- `strftime`
- [man\(3\) – gmtime](#)

## isalnum

Determine if a character is alpha/numeric.

```
int isalnum(int c)
```

Includes:

- `#include <ctype.h>`

See also:

- [man\(3\) – isalnum](#)

## isalpha

Determine if a character is an alpha.

```
int isalpha(int c)
```

Includes:

- `#include <ctype.h>`

See also:

- [man\(3\) – isalpha](#)

### **isascii**

```
int isascii(int c)
```

Includes:

- `#include <ctype.h>`

See also:

- [man\(3\) – isascii](#)

### **isblank**

```
int isblank(int c)
```

Includes:

- `#include <ctype.h>`

See also:

- [man\(3\) – isblank](#)

### **isdigit**

```
int isdigit(int c)
```

Includes:

- `#include <ctype.h>`

See also:

- [man\(3\) – isdigit](#)

### **islower**

```
int islower(int c)
```

Includes:

- `#include <ctype.h>`

See also:

- [man\(3\) – islower](#)

### **isprint**

```
int isprint(int c)
```

Includes:

- `#include <ctype.h>`

See also:

- [man\(3\) – isprint](#)

### **ispunct**

```
int ispunct(int c)
```

Includes:

- `#include <ctype.h>`

See also:

- [man\(3\) – ispunct](#)

### **isspace**

```
int isspace(int c)
```

Includes:

- `#include <ctype.h>`

See also:

- [man\(3\) – isspace](#)

### **isupper**

```
int isupper(int c)
```

Includes:

- `#include <ctype.h>`

See also:

- [man\(3\) – isupper](#)

## itoa

See also:

[man\(3\) –](#)

## labs

`long labs(long val)`

Includes:

- `#include <stdlib.h>`

See also:

- [man\(3\) – labs](#)

## ldiv

`ldiv_t ldiv(long numerator, long demominator)`

Includes:

- `#include <stdlib.h>`

See also:

- [man\(3\) – ldiv](#)

## localtime

`struct tm* localtime(const time_t* timep)`

`struct tm* localtime_r(const time_t* timep, struct tm* result)`

Includes:

- `#include <time.h>`

See also:

- Timers and time
- [man\(3\) – localtime](#)

## lseek

`off_t lseek(int fd, off_t offset, int whence)`

Whence is one of:

- `SEEK_SET`

- SEEK\_CUR
- SEEK\_END

Includes:

- `#include <unistd.h>`

See also:

- [man\(2\) - lseek](#)

## malloc

Allocate storage from the heap.

```
void* malloc(size_t n)
```

When no longer needed, the storage should be returned by a call to `free()`.

Includes:

- `#include <stdlib.h>`

See also:

- `calloc`
- `free`
- `realloc`
- [man\(3\) - malloc](#)

## memchr

Find a character/byte within a given piece of memory.

```
void *memchr(const void *s, int c, size_t n)
```

Includes:

- `#include <string.h>`

See also:

- [man\(3\) - memchr](#)

## memcmp

Compare the content of one piece of memory against another.

```
int memcmp(const void *m1, const void *m2, size_t n)
```

Includes:

- `#include <string.h>`

See also:

- [man\(3\) – memcmp](#)

## **memcpy**

Copy one piece of memory to another.

```
int memcpy(void *dest, const void *src, size_t n)
```

Includes:

- `#include <string.h>`

See also:

- [man\(3\) – memcpy](#)

## **memmove**

Copy memory from one place to another handling overlaps.

```
void *memmove(void *dst, const void *src, size_t n)
```

Includes:

- `#include <string.h>`

See also:

- [man\(3\) – memmove](#)

## **memrchr**

Find a character within a piece of memory searching backwards from the end.

```
void *memrchr(const void *s, int c, size_t n)
```

Includes:

- `#include <string.h>`

See also:

- [man\(3\) – memrchr](#)

## **memset**

Set a piece of memory to a specific value.

```
void *memset(void *dst, int c, size_t n)
```

Includes:

- `#include <string.h>`

See also:

- [man\(3\) – memset](#)

## **mkdir**

Create a directory.

```
int mkdir(const char *pathname, mode_t mode)
```

Returns 0 on success.

Includes:

- `#include <sys/stat.h>`

See also:

- [man\(2\) – mkdir](#)

## **mktime**

```
time_t mktime(struct tm *tm)
```

Includes:

- `#include <time.h>`

See also:

- Timers and time
- [man\(3\) – mktime](#)

## **open**

Open a file.

```
int open(const char *path, int oflag, ...)
```

The `path` is the path to the file to open.

The `oflag` is a set of bitwise flags used to control how the file is opened. One of the following must be supplied:

- `O_RDONLY`
- `O_WRONLY`
- `O_RDWR`

In addition, the following combination may also be supplied:



- `O_APPEND`
- `O_CREAT`
- `O_EXCL`
- `O_TRUNC`

For example:

```
struct stat statBuf;
int fd = open(path, O_RDONLY);
fstat(fd, &statBuf);
data = malloc(statBuf.st_size);
read(fd, data, statBuf.st_size);
close(fd);
```

On return, the value is the handle to the open file descriptor or -1 if there was an error in which case "errno" will be set.

Includes:

- `#include <fcntl.h>`

See also:

- `close`
- `stat`
- `fstat`
- `read`
- `write`
- [man\(3\) – open](#)

## **open\_memstream**

Create a dynamic buffer for writing.

```
FILE *open_memstream(char **ptr, size_t *sizeloc)
```

The return is a FILE pointer that can be used to write into. After an `fclose()` or an `fflush()` the `ptr` and `sizeloc` are updated to point to the buffer and size. The storage should be released with a call to `free()` when done.

Includes:

- `#include <stdio.h>`

See also:

- [man\(3\) – open\\_memstream](#)

## opendir

Open a directory entry for reading.

```
DIR* opendir(const char* name)
```

Open the named directory for reading. If an error is encountered, the return is NULL.

Includes:

- `#include <sys/dirent.h>`

See also:

- `closedir`
- `readdir`
- [man\(3\) – opendir](#)

## printf

Print a formatted string to stdout.

```
int printf(const char *format, ...)
```

Includes:

- `#include <stdio.h>`

See also:

- `fprintf`
- [man\(3\) – printf](#)

## qsort

```
void qsort(  
    void base,  
    size_t nmemb,  
    size_t size,  
    int (*compar)(const void *, const void *))
```

Includes:

- `#include <stdlib.h>`

See also:

- [man\(3\) – qsort](#)

## rand

Generate a random number.

```
int rand()
```

Return a random number. Note that the result is an integer which is signed.

Includes:

- `#include <stdlib.h>`

See also:

- [man\(3\)–rand](#)

## read

Read data from a file or socket.

```
ssize_t read(int fd, void *buf, size_t nbytes)
```

Includes:

- `#include <unistd.h>`

See also:

- [man\(3\)–read](#)

## readdir

Read the next entry from a directory.

```
struct dirent* readdir(DIR* dirp)
```

Retrieve the next directory entry from the DIR cursor that was opened by a previous call to `opendir()`.

The `struct dirent` contains:

- `int d_ino` – A file number.
- `uint8_t d_type` – One of:
  - `DT_UNKNOWN` – Type of file is unknown.
  - `DT_REG` – A regular file.
  - `DT_DIR` – A directory.
- `char d_name[256]` – The name of the file.

NULL is returned if there are no more directory entries to read.

Includes:

- `#include <sys/dirent.h>`

See also:

- `opendir`
- [man\(3\) – readdir](#)

## **realloc**

Reallocate a portion of malloced data to a new size.

```
void *realloc(void *originalData, size_t newSize)
```

Includes:

- `#include <stdlib.h>`

See also:

- `free`
- `calloc`
- `malloc`
- [man\(3\) – realloc](#)

## **rewinddir**

### **scanf**

```
int scanf(const char *format, ...)
```

Includes:

- `#include <stdio.h>`

See also:

- [man\(3\) – scanf](#)

## **seekdir**

Includes:

- `#include <sys/dirent.h>`

## **setenv**

Set the value of an environment variable.

```
int setenv(const char *name, const char *value, int overwrite)
```

## **setlocale**

```
char *setlocale(int category, const char *locale)
```

See also:

- [man\(3\) – setlocale](#)

## settimeofday

Set the current time of day.

```
int settimeofday(const struct timeval *tv, const struct timezone *tz)
```

Includes:

- `#include <sys/time.h>`

See also:

- `gettimeofday`
- Timers and time
- [man\(2\) – settimeofday](#)

## sprintf

Perform a printf to a region of memory.

```
int sprintf(char* out, const char* format, ...)
```

Includes:

- `#include <stdio.h>`

See also:

- [man\(3\) – sprintf](#)

## srand

Set the random number seed.

```
void srand(unsigned int seed)
```

See also:

- [man\(3\) – srand](#)

## sscanf

```
int sscanf(const char* str, const char* format, ...)
```

See also:

- [man\(3\) – scanf](#)

## stat

Get the status of a file by path.

```
int stat(const char* path, struct stat* buf)
```

Includes:

```
#include <sys/stat.h>
```

See also:

- [man\(2\) – stat](#)

## strcasecmp

Compare two strings ignoring case.

```
int strcasecmp(const char* s1, const char* s2)
```

See also:

- [man\(3\) – strcasecmp](#)

## strcasestr

```
char *strcasestr(const char* haystack, const char* needle)
```

See also:

- [man\(3\) – strcasestr](#)

## strcat

Concatenate two strings together.

```
char *strcat(char* dst, const char* src)
```

See also:

- [man\(3\) – strcat](#)

## strchr

Search for a character in a string.

```
char *strchr(const char* s, int c)
```

See also:

- [man\(3\) – strchr](#)

## strcmp

Compare two strings.

```
int strcmp(const char* s1, const char* s2)
```

See also:

- [man\(3\) – strcmp](#)

## strcoll

```
int strcoll(const char* s1, const char* s2)
```

See also:

- [man\(3\) – strcoll](#)

## strcpy

Copy a null terminated string.

```
char *strcpy(char* dst, const char* src)
```

Copy the null terminated string pointed to by "src" to the storage area pointed to by "dst". The destination must have enough storage to hold the source string including its null terminator.

Includes:

- `#include <string.h>`

See also:

- [man\(3\) – strcpy](#)

## strcspn

```
size_t strcspn(const char* s, const char* reject)
```

See also:

- [man\(3\) – strcspn](#)

## strdup

Duplicate the null terminate string via malloc().

```
char *strdup(const char* s)
```

A simple but powerful function. The null terminated string supplied as an input parameter is duplicated by mallocing enough storage to hold a copy and then the string

is actually copied. The returned value is a pointer to the new string copy. The storage for the new string should eventually be released with a call to `free()`.

See also:

- [man\(3\) – strdup](#)

## **strerror**

Convert an error code into a string representation.

```
char *strerror(int errnum)
```

Includes:

- `#include <string.h>`
- `#include <errno.h>`

See also:

- [man\(3\) – strerror](#)

## **strftime**

Format a time into a string representation.

```
size_t strftime(char *s, size_t max, const char *format, const struct tm *tm)
```

See also:

- `gmtime`
- [man\(3\) – strftime](#)

## **strlcat**

```
size_t strlcat(char *dst, const char *src, size_t size)
```

See also:

- [man\(3\) – strlcat](#)

## **strlcpy**

```
size_t strlcpy(char *dst, const char *src, size_t size)
```

See also:

- [man\(3\) – strlcpy](#)

## **strlen**

Return the length of a null terminated string.



```
size_t strlen(const char *s)
```

Return the length of a null terminated string.

See also:

- [man\(3\) – strlen](#)

### **strncasecmp**

```
int strncasecmp(const char *s1, const char *s2, size_t n)
```

See also:

- [man\(3\) – strncasecmp](#)

### **strncat**

```
char *strncat(char *dst, const char *src, size_t count)
```

See also:

- [man\(3\) – strncat](#)

### **strncmp**

```
int strncmp(const char *s1, const char *s2, size_t n)
```

See also:

- [man\(3\) – strncmp](#)

### **strncpy**

```
char *strncpy(char *dst, const char *src, size_t n)
```

See also:

- [man\(3\) – strncpy](#)

### **strndup**

```
char *strndup(const char *s)
```

See also:

- [man\(3\) – strndup](#)

### **strnlen**

```
size_t strnlen(const char *s, size_t maxlen)
```

See also:

- [man\(3\) – strlen](#)

### **strrchr**

char \*strrchr(const char \*s, int c)

See also:

- [man\(3\) – strrchr](#)

### **strsep**

char \*strsep(char \*\*stringp, const char \*delim)

See also:

- [man\(3\) – strsep](#)

### **strspn**

size\_t strspn(const char \*s, const char \*accept)

See also:

- [man\(3\) – strspn](#)

### **strstr**

char \*strstr(const char \*haystack, const char \*needle)

See also:

- [man\(3\) – strstr](#)

### **strtod**

double strtod(const char \*nptr, char \*\*endptr)

See also:

- [man\(3\) – strtod](#)

### **strtof**

float strtof(const char \*nptr, char \*\*endptr)

See also:

- [man\(3\) – strtof](#)

## strtol

long strtol(const char \*str, char \*\*endptr, int base)

See also:

- [man\(3\) – strtol](#)

## strtoul

unsigned long strtoul(const char \*nptr, char \*\*endptr, int base)

See also:

- [man\(3\) – strtoul](#)

## strupr

See also:

[man\(3\) – strupr](#)

## telldir

Includes:

- `#include <sys/dirent.h>`

## time

Retrieve the current time as the number of seconds since the epoch.

```
time_t time(time_t *t)
```

If `t` is supplied, then the time will be stored at that location. If `NULL`, the time will only be returned as a return value.

Includes:

- `#include <time.h>`

See also:

- Timers and time
- `gmtime`
- [man\(2\) – time](#)

## times

```
clock_t times(struct tms *buffer)
```

The struct `tms` contains:

- `clock_t tms_utime` – user time
- `clock_t tms_stime` – system time
- `clock_t tms_cutime` – user time children
- `clock_t tms_cstime` – system time children

See also:

- [Timers and time](#)
- [man\(3\) – times](#)

### **toascii**

```
int toascii(int c)
```

See also:

- [man\(3\) – toascii](#)

### **tolower**

```
int tolower(int c)
```

See also:

- [man\(3\) – tolower](#)

### **toupper**

```
int toupper(int c)
```

See also:

- [man\(3\) – toupper](#)

### **tzset**

Use the time zone information found in the TZ environment variable.

```
void tzset()
```

Examples ...

```
CST+6
```

for example, in code:

```
setenv("TZ", "CST+6", 1);  
tzset();
```

See also:

- [man\(3\) – tzset](#)
- [Specifying the Time Zone with TZ](#)

## ungetc

```
int ungetc(int c, FILE *fp)
```

See also:

- [man\(3\) – ungetc](#)

## unlink

```
int unlink(const char *pathName)
```

Delete a file.

Includes:

- `#include <unistd.h>`

See also:

- [man\(2\) – unlink](#)

## utoa

See also:

- [man\(3\) – utoa](#)

## vprintf

```
int vprintf(const char *format, va_list ap)
```

Includes:

- `#include <stdio.h>`

See also:

- [man\(3\) – vprintf](#)

## vscanf

```
int vscanf(const char *format, va_list ap)
```

Includes:

- `#include <stdio.h>`

See also:

- [man\(3\) – vscanf](#)

## write

```
ssize_t write(int fd, const void *buf, size_t nbyte)
```

See also:

- [man\(3\) – write](#)

## SPIFFs API

See also:

- Spiffs File System
- [Github: pellepl/spiffs](#)

## esp\_spiffs\_format

Format the file system.

```
esp_err_t esp_spiffs_format(const char* partition_label)
```

- `partition_label` – The label of the partition used to hold the SPIFFS file system. If `NULL` then the first partition with `subtype=spiffs` is used.

Includes:

```
#include <esp_spiffs.h>
```

## esp\_spiffs\_info

Retrieve information about the SPIFFS file system.

```
esp_err_t esp_spiffs_info(  
    const char* partition_label,  
    size_t*     total_bytes,  
    size_t*     used_bytes  
)
```

- `partition_label` – The label of the partition used to hold the SPIFFS file system. If `NULL` then the first partition with `subtype=spiffs` is used.
- `total_bytes` – A pointer to a storage area that will return the total number of bytes in the file system.
- `used_bytes` – A pointer to a storage area that will return the total number of bytes used in the file system.

Includes:

```
#include <esp_spiffs.h>
```

### **esp\_spiffs\_mounted**

Determine if the file system is mounted.

```
bool esp_spiffs_mounted(const char* partition_label)
```

- `partition_label` – The label of the partition used to hold the SPIFFS file system. If `NULL` then the first partition with `subtype=spiffs` is used.

Returns `true` if the file system is mounted and `false` otherwise.

Includes:

```
#include <esp_spiffs.h>
```

### **SPIFFS\_check**

Perform a consistency check on the file system.

```
s32_t SPIFFS_check(spiffs *fs)
```

- `fs` – The file system to be checked for consistency.

### **SPIFFS\_clearerr**

Clear the last error.

```
void SPIFFS_clearerr(spiffs *fs)
```

- `fs` – The file system reference.

### **SPIFFS\_close**

Close a previously opened file.

```
s32_t SPIFFS_close(spiffs *fs, spiffs_file fh)
```

- `fs` – The file system reference.
- `fh` – A handle to a previously opened file.

## SPIFFS\_closedir

Close a previously opened directory.

```
s32_t SPIFFS_closedir(spiffs_DIR *dir)
```

- `dir` – A directory previously opened by `SPIFFS_opendir()`.

## SPIFFS\_creat

Create a new file.

```
s32_t SPIFFS_creat(spiffs *fs, const char *path, spiffs_mode mode)
```

- `fs` – The file system reference.
- `path` – The path to the new file.
- `mode` – Ignored.

## SPIFFS\_eof

Determine if we are at the end of the file.

```
s32_t SPIFFS_eof(spiffs *fs, spiffs_file fh)
```

- `fs` – The file system reference.
- `fh` – A handle to an open file.

## SPIFFS\_errno

Returns the last error detected by performing a SPIFFs API call.

```
s32_t SPIFFS_errno(spiffs *fs)
```

- `fs` – The file system reference.

The defined codes are:

- `SPIFFS_OK` – 0
- `SPIFFS_ERR_NOT_MOUNTED` – -10000
- `SPIFFS_ERR_FULL` – -10001 – ENOSPC
- `SPIFFS_ERR_NOT_FOUND` – -10002 – ENOENT
- `SPIFFS_ERR_END_OF_OBJECT` – -10003
- `SPIFFS_ERR_DELETED` – -10004
- `SPIFFS_ERR_NOT_FINALIZED` – -10005



- SPIFFS\_ERR\_NOT\_INDEX -- -10006
- SPIFFS\_ERR\_OUT\_OF\_FILE\_DESCS -- -10007 – ENFILE
- SPIFFS\_ERR\_FILE\_CLOSED -- -10008
- SPIFFS\_ERR\_FILE\_DELETED -- -10009
- SPIFFS\_ERR\_BAD\_DESCRIPTOR -- -10010
- SPIFFS\_ERR\_IS\_INDEX -- -10011
- SPIFFS\_ERR\_IS\_FREE -- -10012
- SPIFFS\_ERR\_INDEX\_SPAN\_MISMATCH -- -10013
- SPIFFS\_ERR\_DATA\_SPAN\_MISMATCH -- -10014
- SPIFFS\_ERR\_INDEX\_REF\_FREE -- -10015
- SPIFFS\_ERR\_INDEX\_REF\_LU -- -10016
- SPIFFS\_ERR\_INDEX\_REF\_INVALID -- -10017
- SPIFFS\_ERR\_INDEX\_FREE -- -10018
- SPIFFS\_ERR\_INDEX\_LU -- -10019
- SPIFFS\_ERR\_INDEX\_INVALID -- -10020
- SPIFFS\_ERR\_NOT\_WRITABLE -- -10021
- SPIFFS\_ERR\_NOT\_READABLE -- -10022
- SPIFFS\_ERR\_CONFLICTING\_NAME -- -10023
- SPIFFS\_ERR\_NOT\_CONFIGURED -- -10024
- SPIFFS\_ERR\_NOT\_A\_FS -- -10025 – Commonly seen when we mount a file system at an SPI address range and the data found on flash isn't formatted as a SPIFFs file system. We can then use `SPIFFS_format()` to format the data and attempt the mount again.
- SPIFFS\_ERR\_MOUNTED -- -10026
- SPIFFS\_ERR\_ERASE\_FAIL -- -10027
- SPIFFS\_ERR\_MAGIC\_NOT\_POSSIBLE -- -10028
- SPIFFS\_ERR\_NO\_DELETED\_BLOCKS -- -10029
- SPIFFS\_ERR\_FILE\_EXISTS -- -10030 – EEXIST
- SPIFFS\_ERR\_NOT\_A\_FILE -- -10031 – EBADF

- SPIFFS\_ERR\_RO\_NOT\_IMPL – -10032
- SPIFFS\_ERR\_RO\_ABORTED\_OPERATION – -10033
- SPIFFS\_ERR\_PROBE\_TOO\_FEW\_BLOCKS – -10034
- SPIFFS\_ERR\_PROBE\_NOT\_A\_FS – -10035
- SPIFFS\_ERR\_NAME\_TOO\_LONG – -10036
- SPIFFS\_ERR\_IX\_MAP\_UNMAPPED – -10037
- SPIFFS\_ERR\_IX\_MAP\_MAPPED – -10038
- SPIFFS\_ERR\_IX\_MAP\_BAD\_RANGE – -10039
- SPIFFS\_ERR\_INTERNAL – -10050
- SPIFFS\_ERR\_TEST – -10100

### **SPIFFS\_fflush**

Flush the content of a file to flash.

```
s32_t SPIFFS_fflush(spiffs *fs, spiffs_file fh)
```

- `fs` – A reference to the file system structure.
- `fh` – A file handle to a previously opened file.

### **SPIFFS\_format**

Format the file system.

```
s32_t SPIFFS_format(spiffs *fs)
```

- `fs` – A reference to the file system structure.

### **SPIFFS\_fremove**

Remove a file by file handle.

```
s32_t SPIFFS_fremove(spiffs *fs, spiffs_file fh)
```

- `fs` – A reference to the file system structure.
- `fh` – A file handle to a previously opened file.

## SPIFFS\_fstat

s32\_t SPIFFS\_fstat(spiffs \*fs, spiffs\_file fh, spiffs\_stat \*s)

- fs – Reference to the file system structure.
- fh – A file handle that has been previously opened.
- s - A pointer to a spiffs\_stat data structure that will be populated.
  - obj\_id
  - size – The size of the file.
  - type – The type of entry. Possibilities are:
    - SPIFFS\_TYPE\_FILE – Entry is a file.
    - SPIFFS\_TYPE\_DIR – Entry is a directory.
    - SPIFFS\_TYPE\_HARD\_LINK – Entry is a hard link.
    - SPIFFS\_TYPE\_SOFT\_LINK – Entry is a soft link.
  - pix – Page index.
  - name – The name of the file.

## SPIFFS\_gc

Perform a garbage collection.

s32\_t SPIFFS\_gc(spiffs \*fs, u32\_t size)

- fs – Reference to the file system structure.
- size – The amount of space being sought.

## SPIFFS\_gc\_quick

s32\_t SPIFFS\_gc\_quick(spiffs \*fs, u16\_t max\_free\_pages)

- fs – Reference to the file system structure.
- max\_free\_pages

## SPIFFS\_info

Determine information about the file system.

s32\_t SPIFFS\_info(spiffs \*fs, u32\_t \*total, u32\_t \*used)

- `fs` – A reference to the file system structure.
- `total` – The total size of the file system.
- `used` – The number of bytes used from the file system.

## SPIFFS\_lseek

Change the file pointer.

```
s32_t SPIFFS_lseek(
    spiffs *fs,
    spiffs_file fh,
    s32_t offs,
    int whence)
```

- `fs` – A reference to the file system structure.
- `fh` – A file handle to an open file.
- `offs` – The numeric by which to change the file pointer.
- `whence` – An indication of how to change the file pointer:
  - `SPIFFS_SEEK_SET` – Change the file pointer to an absolute value.
  - `SPIFFS_SEEK_CUR` – Change the file pointer with reference to its current value.
  - `SPIFFS_SEEK_END` – Change the file pointer relative to the end of the file.

## SPIFFS\_mount

Mount a file system specifying the flash memory address range.

```
s32_t SPIFFS_mount(
    spiffs *fs,
    spiffs_config *config,
    u8_t *work,
    u8_t *fd_space,
    u32_t fd_space_size,
    void *cache,
    u32_t cache_size,
    spiffs_check_callback check_cb_f)
```

- `fs` – The File System control structure.
- `config` – The physical and logical configuration of the file system.
- `work` – A memory buffer that should be  $2 * \log$  page size used for local work.
- `fd_space` – A pointer to memory to hold file descriptor working space. Typically sized at the max number of open file descriptors \* `sizeof(uint32)`.

- `fd_space_size` – The size of the file descriptor space.
- `cache` – Cache memory.
- `cache_size` – The size of cache memory. An example would be (log page size + 32) x 4.
- `check_cb_f` – Callback function invoked to report file system inconsistencies. Can be NULL.

### SPIFFS\_mounted

Determine whether or not the file system is mounted.

```
u8_t SPIFFS_mounted(spiffs *fs)
```

- `fs` – The file system to be checked.

### SPIFFS\_open

Open a new or existing file.

```
spiffs_file SPIFFS_open(
    spiffs *fs,
    const char *path,
    spiffs_flags flags,
    spiffs_mode mode)
```

- `fs` – The reference to the file system control data.
- `path` – The path of the file to be opened or created.
- `flags` – Flags controlling access to the file.
  - `SPIFFS_O_APPEND`
  - `SPIFFS_O_CREAT`
  - `SPIFFS_O_DIRECT`
  - `SPIFFS_O_EXCL`
  - `SPIFFS_O_RDONLY`
  - `SPIFFS_O_RDWR`
  - `SPIFFS_O_TRUNC`
  - `SPIFFS_O_WRONLY`
- `mode` – Ignored.

## SPIFFS\_open\_by\_dirent

Open a file by its directory entry.

```
spiffs_file SPIFFS_open_by_dirent(  
    spiffs *fs,  
    struct spiffs_dirent *entry,  
    spiffs_flags flags,  
    spiffs_mode mode)
```

- `fs` – The reference to the file system control data.
- `entry` – The directory entry to be opened.
- `flags` – Flags controlling access to the file.
  - `SPIFFS_O_APPEND`
  - `SPIFFS_O_DIRECT`
  - `SPIFFS_O_EXCL`
  - `SPIFFS_O_RDONLY`
  - `SPIFFS_O_RDWR`
  - `SPIFFS_O_TRUNC`
  - `SPIFFS_O_WRONLY`
- `mode` – Ignored.

## SPIFFS\_open\_by\_page

Open a file given the page it exists within the file system.

```
spiffs_file SPIFFS_open_by_page(  
    spiffs *fs,  
    spiffs_page_ix page_ix,  
    spiffs_flags flags,  
    spiffs_mode mode)
```

- `fs` – The reference to the file system control data.
- `page_ix` – The page to open.
- `flags` – Flags controlling access to the file.
  - `SPIFFS_O_APPEND`
  - `SPIFFS_O_DIRECT`
  - `SPIFFS_O_EXCL`

- SPIFFS\_O\_RDONLY
- SPIFFS\_O\_RDWR
- SPIFFS\_O\_TRUNC
- SPIFFS\_O\_WRONLY
- mode – Ignored.

### **SPIFFS\_opendir**

Open a directory to work with it.

```
spiffs_DIR *SPIFFS_opendir(spiffs *fs, const char *name, spiffs_DIR *dir)
```

- fs – The reference to the file system control data.
- name – The name of a directory.
- dir – Pointer to the directory structure to be populated.

The return is an opaque data type referring to the directory.

### **SPIFFS\_read**

Read data from an open file.

```
s32_t SPIFFS_read(
    spiffs *fs,
    spiffs_file fh,
    void *buf, s32_t len)
```

- fs – Reference to the file system structure.
- fh – The file handle to a previously opened file.
- buf – The buffer into which to read the data.
- len – The size of the buffer in bytes.

The return is the number of bytes read or -1 if there was an error.

### **SPIFFS\_readdir**

Read the content of a directory.

```
struct spiffs_dirent *SPIFFS_readdir(spiffs_DIR *dir, struct spiffs_dirent *dirent)
```

- `dir` – The directory to be read. An opaque data type returned by `SPIFFS_opendir()`.
- `dirent` – A directory entry that was read.
  - `obj_id` – Internal id of the file.
  - `name` – Name of the file.
  - `type` (`spiffs_obj_type`) – Type of the file. Possibilities are:
    - `SPIFFS_TYPE_FILE` – Entry is a file.
    - `SPIFFS_TYPE_DIR` – Entry is a directory.
    - `SPIFFS_TYPE_HARD_LINK` – Entry is a hard link.
    - `SPIFFS_TYPE_SOFT_LINK` – Entry is a soft link.
  - `size` – Size of the file.
  - `pix` – Page index of the file.

Return NULL on error of end of stream of entries.

### **SPIFFS\_remove**

Remove a file by path.

```
s32_t SPIFFS_remove(spiffs *fs, const char *path)
```

- `fs` – Reference to the file system structure.
- `path` – The path to the file to be removed.

### **SPIFFS\_rename**

Rename a file.

```
s32_t SPIFFS_rename(spiffs *fs, const char *oldPath, const char *newPath)
```

- `fs` – Reference to the file system structure.
- `oldPath` – The old path of the file.
- `newPath` – The new path of the file.

### **SPIFFS\_stat**

Get information about a file.

```
s32_t SPIFFS_stat(spiffs *fs, const char *path, spiffs_stat *s)
```



- `fs` – Reference to the file system structure.
- `path` – The path to the file to be examined.
- `s` - A pointer to a `spifffs_stat` data structure that will be populated.
  - `obj_id`
  - `size` – The size of the file.
  - `type` – The type of entry. Possibilities are:
    - `SPIFFS_TYPE_FILE` – Entry is a file.
    - `SPIFFS_TYPE_DIR` – Entry is a directory.
    - `SPIFFS_TYPE_HARD_LINK` – Entry is a hard link.
    - `SPIFFS_TYPE_SOFT_LINK` – Entry is a soft link.
  - `pix` – Page index.
  - `name` – The name of the file.

### **SPIFFS\_tell**

Find position within file.

```
s32_t SPIFFS_tell(spifffs *fs, spifffs_file fh)
```

- `fs` – Reference to the file system structure.
- `fh` – An open file handle.

### **SPIFFS\_unmount**

Un-mount a previously mounted file system.

```
void SPIFFS_unmount(spifffs *fs)
```

The `fs` is the file system structure previously populated from a `SPIFFS_mount()` call.

See also:

- `SPIFFS_mount`

### **SPIFFS\_write**

Write data into a file.

```
s32_t SPIFFS_write(
    spiffs *fs,
    spiffs_file fh,
    void *buf, s32_t len)
```

- `fs` – A reference to the file system structure.
- `fh` – A file handle previously opened.
- `buf` – A pointer to a buffer containing the data to be written.
- `len` – The length of the data to write.

The return is the number of bytes actually written or -1 if there was an error.

## Eclipse Paho - MQTT Embedded C

The Eclipse Paho project is a collection of implementations of MQTT based functions governed by the Eclipse foundation. Included in this suite is an embedded C implementation which is an MQTT client written in as vanilla a C language as is possible.

See also:

- MQTT
- Eclipse paho
- [Eclipse Paho – embedded C](#)
- [Eclipse Paho](#)

## MQTTClientInit

Initialize an MQTTClient.

```
void MQTTClientInit(
    MQTTClient* c,
    Network *network,
    unsigned int command_timeout_ms,
    unsigned char *sendbuf,
    size_t sendbuf_size,
    unsigned char *readbuf,
    size_t readbuf_size)
```

The network is a populated connection to the target broker.

## MQTTConnect

Connect to a remote MQTT broker.

```
int MQTTConnect(
    MQTTClient *c,
    MQTTPacket_connectData *options)
```

The `options` structure should always be initialized through assignment from `MQTTPacket_connectData_initializer`. For example:

```
MQTTPacket_connectionData data = MQTTPacket_connectData_initializer
```

Once populated, we can then over-ride some of the defaults to reflect our desired changes. Within the object we have:

- `MQTTString clientID` – An identification used by this client.
- `unsigned short keepAliveInterval` – The keep-alive interval for the connection in seconds. If the client doesn't communicate from its last message within this interval then the broker can consider the client lost. The special value of 0 means that there will be no keep-alive checking.
- `unsigned char cleansession` – Set to 1 to begin a clean session otherwise supply 0.
- `unsigned char willFlag`
- `MQTTPacket_willOptions will`
- `MQTTString username` – The user name passed for authentication.
- `MQTTString password` – The password passed for the user for authentication.

The return codes from this call are:

- `SUCCESS (0)` – connected successfully.
- `FAILURE (-1)` – General failure.
- `BUFFER_OVERFLOW (-2)` – Buffer overflow.

Other than these, the returns are MQTT CONNACK responses which are:

- 1 – Unacceptable protocol version.
- 2 – Client identifier rejected.
- 3 – Server unavailable.
- 4 – Bad username or password.
- 5 – Not authorized.

## **MQTTDisconnect**

Disconnect from the broker.

```
int MQTTDisconnect(MQTTClient* c)
```

Following a successful previous call to `MQTTConnect()`, this function disconnects us from the broker.

## MQTTPublish

Publish a message to the broker.

```
int MQTTPublish(  
    MQTTClient *c,  
    const char *topicName,  
    MQTTMessage *message)
```

The `MQTTMessage` is a structure that reflects the message to be published. It includes:

- `enum QoS qos` – The desired quality of service of the published message.
- `unsigned char retained` – Not used in a publish.
- `unsigned char dup` – Not used in a publish.
- `unsigned short id` – The identity of this message.
- `void *payload` – The payload content of this message.
- `size_t payloadlen` – The length of the message payload.

## MQTTRun

```
void MQTTRun(void* parm)
```

## MQTTSubscribe

Subscribe to a topic.

```
int MQTTSubscribe(  
    MQTTClient *c,  
    const char *topicFilter,  
    enum QoS qos,  
    messageHandler messageHandler)
```

The `messageHandler` is a function that is called when a new message is received as published by the broker. The signature of the function is:

```
void func(MessageData *data)
```

The `MessageData` contains:

- `MQTTString *topicName` – The topic on which the message was published. To examine the `topicName`, we should use the form `topicName->lenstring.len` and `topicName->lenstring.data`.

`MQTTMessage *message` – The content of the message received.

The `MQTTMessage` contains:

- `enum QoS qos` – What is the quality of service.
- `unsigned char retained` – Was this a retained message.
- `unsigned char dup` – Was this message sent more than once.
- `unsigned short id` – The id of the message.
- `void *payload` – The payload data of the message.
- `size_t payloadlen` – The length of the payload data.

## MQTTUnsubscribe

Unsubscribe from receiving further publications on the topic.

```
int MQTTUnsubscribe(  
    MQTTClient *c,  
    const char* topicFilter)
```

## MQTTYield

```
int MQTTYield(  
    MQTTClient *c,  
    int timeout_ms)
```

## NetworkConnect

Connect to an MQTT broker

```
int NetworkConnect(Network *network, char *address, int port)
```

If the return is 0, then the connection succeeded.

## Arduino ESP32 Libraries

### Arduino WiFi library

The Arduino has a WiFi library for use with its WiFi shield. A library with a similar interface has been supplied for the Arduino environment for the ESP32.

To use the ESP32 WiFi library you must include its header:

```
#include <WiFi.h>
```

We must also call

```
initWiFi()
```

and

```
startWiFi()
```

before using any of the other WiFi functions in the Arduino library. It is recommended NOT to mix WiFi setup in ESP-IDF with WiFi setup in the Arduino environment.

To be a station and connect to an access point, execute a call to `WiFi.begin(ssid, password)`. Now we need to poll `WiFi.status()`. When this returns `WL_CONNECTED`, then we are connected to the network.

To set up an access point, we would call `WiFi.softAP()` supplying the SSID and password information.

Here is an example of us connecting as a station:

```
WiFi.mode(WIFI_STA);
WiFi.begin(SSID, PASSWORD);
if (WiFi.waitForConnectResult() != WL_CONNECTED) {
    Serial.println("Failed");
    return;
}
WiFi.printDiag(Serial);
// We are now connected as a station
```

See also:

- [Arduino WiFiClient](#)
- [Arduino WiFiServer](#)
- [Arduino WiFi library](#)

### WiFi.begin

Start a WiFi connection as a station.

```
int begin(
    const char *ssid,
    const char *passPhrase=NULL,
    int32_t channel=0,
    uint8_t bssid[6]=NULL)

int begin(
    char *ssid,
    char *passPhrase=NULL,
    int32_t channel=0,
    uint8_t bssid[6]=NULL)
```

Begin a WiFi connection as a station. The `ssid` parameter is mandatory but the others can be left as default. The return value is our current connection status.

Includes:

- [WiFiSTA.h](#)

#### WiFi.beingSmartConfig

`bool beginSmartConfig()`

#### WiFi.beginWPSConfig

`bool beginWPSConfig()`

#### WiFi.BSSID

Retrieve the current BSSID.

```
uint8_t BSSID()  
uint8_t *BSSID(uint8_t networkItem)
```

Retrieve the current BSSID.

Includes:

- [WiFiScan.h](#)
- [WiFiSTA.h](#)

#### WiFi.BSSIDstr

Retrieve the current BSSID as a string representation.

```
String BSSIDstr()  
String BSSIDstr(uint8_t networkItem)
```

Retrieve the current BSSID as a string representation.

Includes:

- [WiFiScan.h](#)
- [WiFiSTA.h](#)

#### WiFi.channel

Retrieve the current channel.

```
int32_t channel()  
int32_t channel(uint8_t networkItem)
```

Retrieve the current channel.

Includes:

- WiFiScan.h
- WiFiGeneric.h

#### WiFi.config

Set the WiFi connection configuration.

```
void config(IPAddress local_ip, IPAddress gateway, IPAddress subnet)
void config(IPAddress local_ip, IPAddress gateway, IPAddress subnet, IPAddress dns)
```

Set the configuration of the WiFi using static parameters. This disables DHCP.

Includes:

- WiFiSTA.h

#### WiFi.disconnect

Disconnect from an access point.

```
int disconnect(bool wifiOff = false)
```

Disconnect from the current access point.

Includes:

- WiFiSTA.h

#### WiFi.dnsIP

Includes:

- WiFiSTA.h

#### WiFi.enableAP

Includes:

- WiFiGeneric.h

#### WiFi.enableSTA

Includes:

- WiFiGeneric.h



### WiFi.encryptionType

Return the encryption type of the scanned WiFi access point.

```
uint8_t encryptionType(uint8_t networkItem)
```

Return the encryption type of the scanned WiFi access point.

The values are one of:

- ENC\_TYPE\_NONE
- ENC\_TYPE\_WEP
- ENC\_TYPE\_TKIP
- ENC\_TYPE\_CCMP
- ENC\_TYPE\_AUTO

Includes:

- WiFiScan.h

### WiFi.gatewayIP

Get the IP address of the station gateway.

```
IPAddress gatewayIP()
```

Retrieve the IP address of the station gateway.

Includes:

- WiFiSTA.h

### WiFi.getAutoConnect

Includes:

- WiFiSTA.h

### WiFi.getMode

Includes:

- WiFiGeneric.h

### WiFi.getNetworkInfo

Retrieve all the details of the specified scanned `networkItem`.

```
bool getNetworkInfo(
    uint8_t networkItem,
    String &ssid,
    uint8_t &encryptionType,
    int32_t &RSSI,
    uint8_t *&BSSID,
    int32_t &channel)
```

Retrieve all the details of the specified scanned `networkItem`.

Includes:

- `WiFiScan.h`

See also:

- `WiFi.scanComplete`
- `WiFi.scanDelete`
- `WiFi.scanNetworks`

### WiFi.hostByName

Lookup a host by a name.

```
int hostByName(const char *hostName, IPAddress &result)
```

Look up a host by name and get its IP address. This function returns 1 on success and 0 on failure.

Includes:

- `WiFiGeneric.h`

### WiFi.hostname

Retrieve and set the hostname used by this station.

```
String hostname()
bool hostname(char *hostName)
bool hostname(const char *hostName)
bool hostname(String hostName)
```

### WiFi.isConnected

Includes:

- `WiFiSTA.h`

### WiFi.isHidden

Determine if the scanned network item is flagged as hidden.

```
bool isHidden(uint8_t networkItem)
```

Determine if the scanned network item is flagged as hidden.

### WiFi.localIP

Get the station IP address.

```
IPAddress localIP()
```

Get the IP address for the station. There is a separate IP address if the ESP is an access point.

Includes:

- WiFiSTA.h

See also:

- WiFi.softAPIP

### WiFi.macAddress

Get the station interface MAC address.

```
uint_t *macAddress(uint8_t *mac)  
String macAddress()
```

Get the station interface MAC address.

Includes:

- WiFiSTA.h

### WiFi.mode

Set the operating mode.

```
void mode(WiFiMode mode)
```

Set the operating mode of the WiFi. This is one of:

- `WIFI_OFF` – Switch off WiFi
- `WIFI_STA` – Be a WiFi station
- `WIFI_AP` – Be a WiFi access point
- `WIFI_AP_STA` – Be both a WiFi station and a WiFi access point

See also:

Includes:

- WiFiGeneric.h

#### Wifi.persistent

Includes:

- WiFiGeneric.h

#### WiFi.printDiag

Log the state of the WiFi connection.

```
void printDiag(Print &dest)
```

Log the state of the WiFi connection. We can pass in either Serial or Serial1 as an argument to log the data to the Serial port. An example of output is as shown next:

```
Mode: STA  
PHY mode: N  
Channel: 7  
AP id: 0  
Status: 5  
Auto connect: 0  
SSID (7): yourSSID  
Passphrase (8): yourPassword  
BSSID set: 0
```

Note that the status value is the result of a `wifi_station_get_connect_status()` call.

Includes:

- WiFi.h

#### WiFi.psk

Includes:

- WiFiSTA.h
- 

#### WiFi.RSSI

Retrieve the RSSI (Received Signal Strength Indicator) value of the scanned network item.

```
int32_t RSSI(uint8_t networkItem)
```

Retrieve the RSSI value of the scanned network item.

Includes:

- WiFiScan.h

- WiFiSTA.h

### WiFi.scanComplete

Determine the status of a previous scan request.

```
int8_t scanComplete()
```

If the result is  $\geq 0$  then this is the number of WiFi access points found. Otherwise, the value is less than 0 and the codes are:

- SCAN\_RUNNING – A scan is currently in progress.
- SCAN\_FAILED – A scan failed.

Includes:

- WiFiScan.h

See also:

- WiFi.scanNetworks
- WiFi.scanDelete

### WiFi.scanDelete

Delete the results from a previous scan.

```
void scanDelete()
```

Delete the results from a previous scan. A request to scan the network results in the allocation of memory. This call releases that memory.

Includes:

- WiFiScan.h

See also:

- WiFi.scanComplete
- WiFi.scanNetworks
- WiFi.getNetworkInfo

### WiFi.scanNetworks

Scan the access points in the environment.

```
int8_t scanNetworks(bool async = false, bool show_hidden = false)
```

Scan the access points in the environment. We can either perform this synchronously or asynchronously. On a synchronous call, the result is the number of access points found.

Includes:

- WiFiScan.h

See also:

- WiFi.scanComplete
- WiFi.scanDelete
- WiFi.getNetworkInfo

### WiFi.setAutoConnect

Includes:

- WiFiSTA.h

### WiFi.setAutoReconnect

Includes:

- WiFiSTA.h

### WiFi.smartConfigDone

```
bool smartConfigDone()
```

### WiFi.softAP

Setup an access point.

```
void softAP(const char *ssid)
void softAP(const char *ssid,
            const char *passPhrase,
            int channel=1,
            int ssid_hidden=0)
```

The `ssid` is used to advertize our network. The `passPhrase` is the password a station must supply in order to be authorized to access.

Includes:

- WiFiAP.h

### WiFi.softAPConfig

```
void softAPConfig(IPAddress local_ip, IPAddress gateway, IPAddress subnet)
```

Includes:

- WiFiAP.h

### WiFi.softAPdisconnect

```
int softAPdisconnect(bool wifiOff=false)
```

Includes:

- WiFiAP.h

### WiFi.softAPmacAddress

Get the MAC address of the access point interface.

```
uint8_t *softAPmacAddress(uint8_t *mac)  
String softAPmacAddress()
```

Get the MAC address of the access point interface.

Includes:

- WiFiAP.h

### WiFi.softAPIP

Get the IP address of the access point interface.

```
IPAddress softAPIP()
```

Return the IP address of the access point interface. There is a separate IP for the station.

See also:

- WiFi.localIP

### WiFi.SSID

Retrieve the SSID.

```
char *SSID()  
const char *SSID(uint8_t networkItem)
```

Here we retrieve the SSID of the current station or the SSID of the scanned network id.

Includes:

- WiFiScan.h
- WiFiSTA.h

#### WiFi.status

Retrieve the current WiFi status.

```
wl_status_t status()
```

The status returned will be one of:

- WL\_IDLE\_STATUS (0)
- WL\_NO\_SSID\_AVAIL (1)
- WL\_SCAN\_COMPLETED (2)
- WL\_CONNECTED (3)
- WL\_CONNECT\_FAILED (4)
- WL\_CONNECTION\_LOST (5)
- WL\_DISCONNECTED (6)

Includes:

- WiFiSTA.h

#### WiFi.stopSmartConfig

```
void stopSmartConfig()
```

#### WiFi.subnetMask

```
IPAddress subnetMask()
```

Includes:

- WiFiSTA.h

#### WiFi.waitForConnectResult

Wait until the WiFi connection has been formed or failed.

```
uint8_t waitForConnectResult()
```



If we are a station, then block waiting for us to become connected or failed. The return code is the status. Specifically, this function watches the status to see when it becomes something other than `WL_DISCONNECTED`. Perhaps a more positive form of this function would be:

```
while (WiFi.status() != WL_CONNECTED) {
    delay(500);
    Serial.print(".");
}
```

Includes:

- `WiFiSTA.h`

## Arduino WiFiClient

This library provides TCP connections to a partner. A separate class provides UDP communications.

To use this library, you must include `"WiFi.h"`.

We create an instance of this class and then connect to a partner using the `connect()` method.

### WiFiClient

#### WiFiClient.available

Return the amount of data available to be read.

```
int available()
```

Return the amount of data available to be read.

#### WiFiClient.connect

Connect to the given host at the given port using TCP.

```
int connect(const char* host, uint16_t port)
int connect(IPAddress ip, uint16_t port)
```

Connect to the given host at the given port using TCP. This function returns `0` on a failure.

### WiFiClient.connected

Determine if we are connected to a partner.

```
uint8_t connected()
```

Return true if connected and false otherwise.

### WiFiClient.flush

```
void flush()
```

### WiFiClient.getNoDelay

```
bool getNoDelay()
```

### WiFiClient.peek

```
int peek()
```

### WiFiClient.read

Read data from the partner.

```
int read()  
int read(uint8_t *buf, size_t size)
```

Read data from the partner. These functions read either a single byte or a sequence of bytes from the partner.

### WiFiClient.remoteIP

Retrieve the remote IP address of the connection.

```
IPAddress remoteIP()
```

Retrieve the remote IP address of the connection.

### WiFiClient.remotePort

Return the remote port being used in an existing connection.

```
uint16_t remotePort()
```

Return the remote port being used in an existing connection.

### WiFiClient.setLocalPortStart

Set the initial port for allocating local ports for connections.

```
void setLocalPortStart(uint16_t port)
```

Set the initial port for allocating local ports for connections.

### WiFiClient.setNoDelay

```
void setNoDelay(bool nodelay)
```

### WiFiClient.setOption

```
int setOption(int option, int *value)
```

### WiFiClient.status

```
uint8_t status()
```

### WiFiClient.stop

Disconnect a client.

```
void stop()
```

Disconnect a client.

### WiFiClient.stopAll

Stop all the connections formed by this WiFi client.

```
void stopAll()
```

### WiFiClient.write

Write data to the partner.

```
size_t write(uint8_t b)  
size_t write(const uint8_t *buf, size_t size)  
size_t write(T& source, size_t unitSize);
```

Write data to the partner. The first function writes one byte, while the second function writes an array of characters.

## Arduino WiFiServer

### WiFiServer

Create an instance of a Server listening on the supplied port.

```
WiFiServer(uint16_t port)
```

Create an instance of a Server listening on the supplied port. Interesting, it appears that once we create a server instance within an ESP8266, there is no way to stop it running.

### WiFiServer.available

Retrieve a WiFiClient object that can be used for communications.

```
WiFiClient available(byte* status)
```

Retrieve the corresponding WiFiClient.

See also:

- [Arduino WiFiClient](#)

### WiFiServer.begin

Start listening for incoming connections.

```
void begin()
```

Start listening for incoming connections. Until this method is called, the ESP8266 doesn't accept incoming connections. Interestingly, once called, there is no obvious way to stop listening. The port used for the incoming connections is the one supplied when the WiFiServer object was constructed.

### WiFiServer.getNoDelay

### WiFiServer.hasClient

Return true if we have a client connected.

```
bool hasClient()
```

### WiFiServer.setNoDelay

### WiFiServer.status

### WiFiServer.write

WARNING!! This method is not implemented.

```
size_t write(uint8_t b)
size_t write(const uint8_t *buffer, size_t size)
```

Although present on the interface, this method is not yet implemented.

## Arduino IPAddress

A representation of an IPAddress. This class has some operator overrides:

[i] – Get the ith byte of the address. I should be 0-3.

## Arduino SPI

The Arduino SPI library is loaded from the "SPI.h" header file and provides the SPI interface.

### SPI.begin

Begin to use the SPI bus.

```
void begin(int8_t sck=-1, int8_t miso=-1, int8_t mosi=-1, int8_t ss=-1)
```

The `sck` is the pin to use for clock. The `miso` is the pin to use for MISO, the `mosi` is the pin to use for MOSI, the `ss` is the pin to use for SS.

### SPI.beginTransaction

Begin a transaction.

```
void beginTransaction(SPISettings settings)
```

The `settings` is an instance of an SPISettings object. This is constructed with three parameters:

```
SPISettings(uint32_t clock, uint8_t bitOrder, uint8_t dataMode)
```

This sets the clock speed, bit order and data mode.

### SPI.end

Stop using the bus.

```
void end()
```

### SPI.endTransaction

End a transaction.

```
void endTransaction(void)
```

### SPI.setBitOrder

Set the bit order value.

```
void setBitOrder(uint8_t bitOrder)
```

### SPI.setClockDivider

Set the clock divider value.

```
void setClockDivider(uint32_t clockDiv)
```

### SPI.setDataMode

Set the data mode value.

```
void setDataMode(uint8_t dataMode)
```

### SPI.setFrequency

Set the frequency value.

```
void setFrequency(uint32_t freq)
```

### SPI.setHwC

```
void setHwCs(bool use)
```

### SPI.transfer

```
uint8_t transfer(uint8_t data)
```

### SPI.transfer16

```
uint16_t transfer16(uint16_t data)
```

### SPI.transfer32

```
uint32_t transfer32(uint32_t data)
```

### SPI.transferBytes

```
void transferBytes(uint8_t * data, uint8_t * out, uint32_t size)
```

### SPI.transferBits

```
void transferBits(uint32_t data, uint32_t * out, uint8_t bits)
```

### SPI.write

```
void write(uint8_t data)
```

### SPI.write16

```
void write16(uint16_t data)  
void write16(uint16_t data, bool msb)
```

### SPI.write32

```
void write32(uint32_t data)  
void write32(uint32_t data, bool msb)
```

### SPI.writeBytes

```
void writeBytes(uint8_t * data, uint32_t size)
```

### SPI.writePattern

```
void writePattern(uint8_t * data, uint8_t size, uint32_t repeat)
```

## **Arduino I2C - Wire**

The `wire` class provides I2C support. In order to use this class, import "`wire.h`" into your sketch. When we use this class, a global instance called "`wire`" is made available to us. One wire is called SCL which provides the clock while the other wire is called SDA and is the data bus. On the Arduino, the library supports being either a master or a slave however in the current implementation, only being a master is supported.

To use this class, first we define which pins should be used and then start the service.

```
Wire.begin(SDApin, SCLpin);
```

To send data, we begin a transmission using `beginTransaction()`:

```
Wire.beginTransaction(deviceAddress);
```

now we can write some data ...

```
Wire.write(value);
```

and finally complete the transmission:

```
Wire.endTransmission();
```

if we wish to receive data from the slave, we can call `requestFrom()`:

```
Wire.requestFrom(deviceAdress, size, true);
```

and data can be read using the `available()` and `read()` functions.

See also:

- Working with I2C
- Arduino – [Wire Library](#)

### Wire.available

Determine the number of bytes available to read.

```
int available(void)
```

Determine the number of bytes available to read.

See also:

- `Wire.read`
- `Wire.requestFrom`

### Wire.begin

Initialize the wire library.

```
void begin(int SDApin, int SCLpin)
void begin()
void begin(uint8_t address)
void begin(int address)
```

Initialize the wire library. When an address is supplied, we are a slave otherwise we are a master. We can also specify the pins to be used for SDA and SCL. If we are a master and no pins are supplied, we will use the default pins.

**WARNING!!** – It appears that there is **NO** support for actually being a slave and only a master is supported at this time.

**WARNING!!** – In the current code, the `address` parameter is ignored!!



See also:

- [Wire.pins](#)

### Wire.beginTransmission

Begin a transmission block to a slave.

```
void beginTransmission(uint8_t address)
void beginTransmission(int address)
```

Begin the notion of sending a transmission to a slave device with the supplied address. Further calls to `write()` will queue data to be transmitted which is finally executed with a call to `endTransmission()`.

### Wire.endTransmission

End the bracketing of a transmission.

```
uint8_t endTransmission(void) // Defaults to sendStop = true
uint8_t endTransmission(uint8_t sendStop)
```

End the bracketing of a transmission and perform the actual transmit. The return codes are:

- 0 – Transmitted correctly
- 2 – Received NACK on transmit of address
- 3 – Received NACK on transmit of data
- 4 – line busy

### Wire.flush

Discard any un-read or un-written data.

```
void TwoWire::flush(void)
```

Discard any un-read or un-written data. A call to `available()` will return 0 and a call to `endTransmission()` will transmit no data.

### Wire.onReceive

A callback when we are in the role of a slave and receive a transmission from a master.

```
void onReceive( void (*function)(int numBytes))
```

A callback when slave receives a transmission from a master.

**WARNING!!** – This function is not implemented.

#### Wire.onReceiveService

Not implemented.

```
void onReceiveService(uint8_t* inBytes, int numBytes)
```

Not implemented.

**WARNING!!** – This function is not implemented.

#### Wire.onRequest

A callback invoked when we are in the role of a slave and a master requests data from us.

```
void onRequest(void (*function)(void))
```

A callback invoked when we are in the role of a slave and a master requests data from us.

**WARNING!!** – This function is not implemented.

#### Wire.onRequestService

Not implemented.

```
void onRequestService(void)
```

Not implemented.

**WARNING!!** – This function is not implemented.

#### Wire.peek

Peek at the next byte.

```
int peek(void)
```

Peek at the next byte if one is available. A return of -1 if there is no byte available.

#### Wire.pins

**WARNING!!** - This function has been deprecated in favor of `begin(sda, scl)`.

Define the default pins for SDA and SCL.

```
void pins(int sda, int scl)
```

Define the default pins for SDA and SCL.

See also:

- [Wire.begin](#)

### Wire.read

Read a single byte.

```
int read(void)
```

Read a single byte from the bus. A value of `-1` is returned if there is no byte available.

See also:

- [Wire.available](#)
- [Wire.requestFrom](#)

### Wire.requestFrom

Request data from a slave.

```
size_t requestFrom(uint8_t address, size_t size, bool sendStop)
uint8_t requestFrom(uint8_t address, uint8_t quantity, uint8_t sendStop)
uint8_t requestFrom(uint8_t address, uint8_t quantity)
uint8_t requestFrom(int address, int quantity)
uint8_t requestFrom(int address, int quantity, int sendStop)
```

Request data from a slave. This method should be called when we are playing the role of a master. The `address` parameter defines the slave address for the device that should respond. If the `sendStop` is true, a stop message is transmitted releasing the I2C bus. If `sendStop` is false, a restart message is transmitted preventing another bus master from taking control.

The `quantity` parameter states how many bytes we wish to receive.

The return value is the number of bytes that were received.

See also:

- [Wire.read](#)
- [Wire.available](#)

### Wire.setClock

Set the clock frequency.

```
void setClock(uint32_t frequency)
```

Set the clock frequency. Always call `setClock()` AFTER a call to `begin()`.

### Wire.write

Write one or more bytes to the slave.

```
size_t write(uint8_t data)
size_t write(const uint8_t *data, size_t quantity)
```

Write one or more bytes to the slave.

## Arduino Ticker library

This library sets up callback functions that are called after a period of time. To use this library you must include "Ticker.h". For example:

```
#include <Ticker.h>

void timerCB() {
    Serial1.println("Tick ...");
}

void setup()
{
    Serial1.begin(115200);
    ticker.attach(5, timerCB);
    Serial1.println("Ticker attached");
}
```

### Ticker

An instance of a Ticker object. Commonly this is created as a global such as:

```
Ticker myTicker;
```

### attach

Attach a callback function to the ticker.

```
void attach(float seconds,
            callback_t callback)
void attach(float seconds,
            void (*callback) (TArg),
            TArg arg)
```

Attach a callback function to the ticker such that the callback is invoked each period of seconds. Note that seconds is a float so we can specify values such as 0.1 to indicate a callback every 1/10th of a second (100 milliseconds).

The `callback_t` is defined as:

```
void (*callback_t)(void)
```

### attach\_ms

**Attach a callback function to the ticker.**

```
void attach_ms(uint32_t milliseconds,  
               callback_t callback)  
void attach_ms(uint32_t milliseconds,  
               void (*callback)(TArg), TArg arg)
```

Attach a callback function to the ticker such that the callback is invoked each period of milliseconds. Only one attachment can be made to a timer.

### detach

**Detach a ticker from the timer.**

```
void detach()
```

Detach a callback function from the timer. No further callbacks will occur.

### once

**Attach a callback function to the timer for a one-shot firing.**

```
void once(float seconds,  
          callback_t callback)  
void once(float seconds,  
          void (*callback)(TArg),  
          TArg arg)
```

Attach a callback function to the timer for a one-shot firing. Note that seconds is a float so we can specify values such as 0.1 to indicate a callback every 1/10th of a second (100 milliseconds).

### once\_ms

**Attach a callback function to the timer for a one-shot firing.**

```
void once_ms(uint32_t milliseconds,  
             callback_t callback)  
void once_ms(uint32_t milliseconds,  
             void (*callback)(TArg),  
             TArg arg)
```

Attach a callback function to the timer for a one-shot firing.

## Arduino EEPROM library

This library allows us to store and retrieve data from storage that persists across a device restart. A singleton object called EEPROM is pre-supplied for use.

### EEPROM.begin

Begin the process of writing or reading from EEPROM. The size is the amount of storage we wish to work with.

```
void begin(size_t size)
```

### EEPROM.commit

The changes to the data are committed to EEPROM. A return of `true` indicates success while a return of `false` indicates a failure.

```
bool commit()
```

### EEPROM.end

Commits the changes to the data and then releases any local storage. No further reads or writes should be attempted until after the next `begin()` call.

```
void end()
```

### EEPROM.get

Read a data structure from storage.

```
T &get(int address, T &t)
```

### EEPROM.getDataPtr

Retrieve a pointer to the storage we are going to read or write.

```
uint8_t *getDataPtr()
```

### EEPROM.put

Put a data structure to storage.

```
const T &put(int address, const T &t)
```

### EEPROM.read

Read a byte from storage.

```
uint8_t read(int address)
```

### EEPROM.write

Write a byte to storage.

```
void write(int address, uint8_t value)
```

## Arduino SPIFFS

FS is the File System library which provides the ability to read and write files from within the Arduino ESP environment. But wait ... read and write files to where? There are no "drives" on an ESP8266. The data for the files is read and written to an area of flash memory and since flash is relatively small in size (4MBytes or so max) then that is an upper bound of maximum size of the cumulative files ... however, this is still more than enough for many usage patterns such as saving state, logs or configuration information.

### SPIFFS.begin

Begin working with the SPIFFS file system.

```
bool begin()
```

Returns true of success and false otherwise.

### SPIFFS.open

Open the named file.

```
File open(const char *path, const char *mode)  
File open(const String &path, const char *mode)
```

The mode defines how we wish to access the file. The options are:

- `r` – Read the file. The file must exist.
- `w` – Write to the file. Truncate the file if it exists.
- `a` – Append to the file.
- `r+` – Read and write the file.
- `w+` – Read and write the file.
- `a+` – Read and write the file.

## See also:

- [File.close](#)

### SPIFFS.openDir

Open a directory.

```
Dir openDir(const char *path)
Dir openDir(const String &path)
```

### SPIFFS.remove

Remove/delete a file from the file system.

```
bool remove(const char *path)
bool remove(const String &path)
```

### SPIFFS.rename

Rename a file.

```
bool rename(const char *pathFrom, const char *pathTo)
bool rename(const String &pathFrom, const String &pathTo)
```

### File.available

Return the number of bytes that are available within the file from the current file position to its maximum size.

```
int available()
```

### File.close

Close a previously opened file.

```
void close()
```

No further reading nor writing should be attempted to be performed.

### File.flush

Flush the file.

```
void flush()
```

### File.name

Retrieve the name of the file.



```
const char *name()
```

### File.peek

Peek at the next byte of data in the file without consuming it.

```
int peek()
```

### File.position

Retrieve the current file pointer position.

```
size_t position()
```

### File.read

Read data from the file.

```
int read()  
size_t read(uint8_t *buf, size_t size)
```

Read either a single byte of data or a buffer of data from the file.

### File.seek

Change the current file pointer position.

```
bool seek(uint32_t pos, SeekMode mode)
```

The mode can be one of:

- `SeekSet` – Change the file pointer position to the absolute value.
- `SeekCur` – Change the file pointer position to be relative to the current position.
- `SeekEnd` – Change the file pointer position to be relative to the end of the file.

### File.size

Retrieve the maximum size of the file.

```
size_t size()
```

### File.write

Write data to the file.

```
size_t write(uint8_t c)
size_t write(uint8_t *buf, size_t size)
```

Write either a single byte or a buffer of bytes into the file at the current file pointer position.

#### Dir.fileName

Retrieve the name of the file.

String fileName()

#### Dir.next

bool next()

#### Dir.open

```
File open(const char *mode)
File open(String &path, const char *mode)
```

#### Dir.openDir

```
Dir openDir(const char *path)
Dir openDir(String &path)
```

#### Dir.remove

#### Dir.rename

### Arduino ESP library

A class has been provided called ESP that provides ESP8266 environment specific functions. You must realize that using these functions will result in your applications not being portable to the Arduino (if that is a desire).

#### ESP.eraseConfig

```
bool eraseConfig()
```

#### ESP.getChipId

```
uint32_t getChipId()
```

#### ESP.getCpuFreqMHz

```
uint8_t getCpuFreqMHz()
```

### ESP.getCycleCount

uint32\_t getCycleCount()

### ESP.getFlashChipMode

FlashMode\_t getFlashChipMode()

### ESP.getFlashChipSize

uint32\_t getFlashChipSize()

### ESP.getFlashChipSpeed

uint32\_t getFlashChipSpeed()

### ESP.getFreeHeap

uint32\_t getFreeHeap()

### ESP.getOption

int getOption(int option, int \*value)

### ESP.getSdkVersion

Retrieve the string representation of the SDK being used.

const char \*getSdkVersion()

### ESP.flashEraseSector

bool flashEraseSector(uint32\_t sector)

### ESP.flashRead

bool flashRead(uint32\_t offset, uint32\_t \*data, size\_t size)

### ESP.flashWrite

bool flashWrite(uint32\_t offset, uint32\_t \*data, size\_t size)

### ESP.magicFlashChipSize

```
uint32_t magicFlashChipSize(uint8_t byte)
```

### ESP.magicFlashChipSpeed

```
uint32_t magicFlashChipSpeed(uint8_t byte)
```

### ESP.restart

```
void restart()
```

## Arduino String library

Although it is believed that this library may be identical to the Arduino String library, I believe it is so essential to understand that I am going to list the methods again.

## String

### Constructor

```
String(const char *cstr = "");  
String(const String &str)  
String(char c)  
String(unsigned char, unsigned char base = 10)  
String(int, unsigned char base = 10)  
String(long, unsigned char base = 10)  
String(unsigned long, unsigned char base = 10)  
String(float, unsigned char decimalPlaces = 2)  
String(double, unsigned char decimalPlaces = 2)
```

Create an instance of the String class seeded with various data type initializers.

### String.c\_str

Retrieve a C string representation.

```
const char *c_str()
```

### String.reserve

```
unsigned char reserve(unsigned int size)
```

### String.length

Return the length of the string.

```
unsigned int length()
```

Return the length of the string.

### String.concat

```
unsigned char concat(const String &str)
unsigned char concat(const char *cstr)
unsigned char concat(char c)
unsigned char concat(unsigned char c)
unsigned char concat(int num)
unsigned char concat(unsigned int num)
unsigned char concat(long num)
unsigned char concat(unsigned long num)
unsigned char concat(float num)
unsigned char concat(double num)
```

### String.equalsIgnoreCase

```
unsigned char equalsIgnoreCase(const String &s) const;
```

### String.startsWith

Determine whether or not this string starts with another string.

```
unsigned char startsWith(const String &prefix)
unsigned char startsWith(const String &prefix, unsigned int offset)
```

### String.endsWith

```
unsigned char endsWith(const String &suffix)
```

### String.charAt

```
char charAt(unsigned int index)
```

### String.setCharAt

```
void setCharAt(unsigned int index, char c)
```

### String.getBytes

```
void getBytes(unsigned char *buf, unsigned int bufsize, unsigned int index = 0)
```

### String.toCharArray

```
void toCharArray(char *buf, unsigned int bufsize, unsigned int index = 0)
```

### String.indexOf

Find the position of a string or character within the current string.

```
int indexOf(char ch)
int indexOf(char ch, unsigned int fromIndex)
int indexOf(const String &str)
int indexOf(const String &str, unsigned int fromIndex)
```

Find the position of a string or character within the current string. If the match is not found, -1 is returned otherwise the position of the start of the match is returned.

### String.lastIndexOf

```
int lastIndexOf(char ch)
int lastIndexOf(char ch, unsigned int fromIndex)
int lastIndexOf(const String &str)
int lastIndexOf(const String &str, unsigned int fromIndex)
```

### String.substring

Retrieve a substring from within the current string.

```
String substring(unsigned int beginIndex)
String substring(unsigned int beginIndex, unsigned int endIndex)
```

Retrieve a substring from within the current string.

### String.replace

```
void replace(char find, char replace)
void replace(const String& find, const String& replace)
```

### String.remove

```
void remove(unsigned int index)
void remove(unsigned int index, unsigned int count)
```

### String.toLowerCase

```
void toLowerCase(void)
```

### String.toUpperCase

```
void toUpperCase(void)
```

### String.trim

```
void trim(void)
```

### String.toInt

```
long toInt(void)
```

### String.toFloat

```
float toFloat(void)
```

## Reference materials

There is a wealth of information available on the ESP32 from a variety of sources.

### Read-The-Docs

Some of the best knowledge on the ESP32 comes from the Github source of the ESP-IDF. The project contains markup documentation that is hand written and also the source files are mechanically scanned. The result is some superb documentation that can be found here:

<http://esp-idf.readthedocs.io/en/latest/>

## Internal structure of compiled code

When you compile a C or C++ source file, the result is a binary file called an "object" file. This contains the compiled code generated from the source. Within this file are:

- `symbols` – references to program or memory data.
- `sections` – TBD
  - `.text` – Compiled code.
  - `.data` – Initialized data.
  - `.bss` – Uninitialized data. Zeroed on load.
  - `.comment`
  - `.ctors`
  - `.data1`
  - `.debug`
  - `.dtors`
  - `.rodata`
  - `.rodata1`

To produce the final executable, multiple object files are linked together. The result is the combination of each of the sections in a process known as tiling. All the sections of the same type are aggregated together and address references are "fixed up" to point to their ultimate locations.

For a C program, there are two startup routines invoked before `main()`. These are:

- `crt0`
- `crt1`

### Related tools

- `objdump`
- `nm`
- `readelf`

When the ESP32 is booted, a loader executes to prepare the application for execution. Before power-on, the application is 100% stored in flash memory. When control is given to the application, some of that memory must be loaded into different areas of RAM.

In modern operating systems, applications don't normally contain all the code they need to execute. Instead, they contain references to dynamically loaded code. In windows these would be DLLs and on Linux they would be called shared libraries. When an executable uses such shared libraries, they need to be dynamically linked when the program is loaded. In the ESP32, everything is *statically linked*. What that means is that the application written to flash contains **all** the code that it needs to execute. It is fully self contained.

Good use of these tools has taught us some good lessons in saving RAM which is the ESP32's most precious commodity.

- Use `char []` instead of `char *`

Imagine we want to have constant strings. For example:

```
const char *message1 = "Don't switch off";
const char *message2 = "Ok to switch on";
```

It turns out that the text is held in RAM. If we change our code to:

```
const char message1[] = "Don't switch off";
const char message2[] = "Ok to switch on";
```

The text is held in flash and consumes no extra RAM.

- Take care with structures that include `std::string`

We had created a structure that looked like:

```
struct data_t {
    std::string name;
    uint32_t value;
}
```

and had coded an array of these using:

```
const struct data_t myData[] = {
    {"message1", 1},
    {"message2", 2},
    ...
};
```

When we looked at the output from `"nm"`, we found that the data was being held in RAM. The answer for this is obvious in hind-sight. The property called `"name"` is a class instance. That means that the initialization of each instance of `struct data_t` created a class instance in RAM. We changed our definition of `struct data_t` to:



```
struct data_t {
    const char* name;
    uint32_t    value;
}
```

and the data ends up in flash.

## Using size

List the sizes of sections contained within an object file.

For example:

```
$ xtensa-esp32-elf-size -d app-template.elf
  text      data      bss      dec      hex      filename
546909     151460     28360     726729     b16c9     app-template.elf
```

See also:

- [man\(1\) – size](#)

## Using objdump

### Using objcopy

Sometimes we want to look at the content of a section. Objcopy is a good candidate for that task.

For example

```
xtensa-esp32-elf-objcopy --output-target=binary -only-section=.flash.text infile
outfile
```

See also:

- [objcopy](#)

## Using nm

The nm tool uses codes to indicate the type of symbol displayed:

- U – The symbol is undefined. This means that there is a reference to the symbol but that the symbol is declared in another object file. The symbol must be resolved before we can execute the related code. Lower case letters are local data while upper case are global data.
- T or t – Text (code).
- R or r – Read only data section.

- B or b – Uninitialized data, also known as BSS.
- W or w – A weakly defined symbol.
- n
- N – Debugging symbol.
- D or d – Initialized data.

#### Notes:

- When working with C++, consider "-c" to demangle names.
- Adding "-l" will show file name and line number.
- Adding "-s" will show the size of the symbol.

#### See also:

- [man\(1\)-nm](#)

## Linking

When we compile a C source file we end up with an object file that has the file suffix ".o". At the highest level, compilation generates two core components within an object file. These are the "code" and the "data". The code are the binary instructions executed by the ESP32. The data are the global variables that may need to be accessed by multiple object files.

When we compile a source file to generate an object file, the resulting object file contains place holders for the reference to data and other functions. For example, if you had the following piece of C code:

```
extern int a;
extern void b();
void func() {
    a = a + 1;
    b();
}
```

And compiled it ... it would not be able to execute by itself. This is because it references items called "a" and "b" for which the generated code does not *know* their addresses. The compiled code realizes that before execution, the addresses need to be resolved. Another way of saying this is that in the resulting object file, "a" and "b" are unresolved.

Now imagine another piece of C code:

```
int a;
void b() {
```

```

    // Do something;
}

```

If this code were compiled it would *expose* or *offer* symbols for resolution within other object files.

The process of linking takes all the object files we need and maps them together resulting in a new binary that contains all the code and all the data from each of the object files but with the unresolved symbols (the place holders) resolved to the addresses of their definitions.

We can run the `xtensa-esp32-elf-nm -format=sysv <object>|<exe>` over our files. An example would be:

Symbols from b:

Name	Value	Class	Type	Size	Line	Section
b	00400078	T	FUNC	00000018		.text
__bss_start	00400094	D	NOTYPE			.data
__edata	00400094	D	NOTYPE			.data
__end	00400094	D	NOTYPE			.data
__start		U	NOTYPE			*UND*
x	00400090	D	OBJECT	00000004		.data

Within a running system, we can think of the existence of distinct segments of address space / memory.

- code / text segment – Where executable code goes
- data segment – Where initialized data goes
- bss segment – Un-initialized (zeroed) data

#### Terms

- segments – contiguous chunks of storage by function
- imports – imported symbols that are to be resolved
- exports – exported symbols that are used to resolve
- symbol table
- 

See also:

- [Beginner's Guide to Linkers](#)

## Linker scripts

Within an ld file, we have a number of sections where declarations go. Primary among these are:

- MEMORY
- SECTIONS
- ENTRY

The MEMORY area defines named segments. It has the format:

```
MEMORY
{
    <segmentName> (<accessor>: org = <base address>, len = <length>
    <segmentName> : org = <base address>, len = <length>
}
```

Common accessor include:

- RX – Read and execute
- RW – Read and write
- R – Read only
- RWX – Read, write and execute

The SECTIONS area contains:

```
SECTIONS {
    <sectionName> : {
        // section logic
    }
}
```

Following a section definition, we can have qualifiers. For example:

```
<sectionName> : {
    // section declarations
} ><segmentName>
```

causes the section to be placed inside the named segment.

Here are some examples:

```
.flash.text : {
    *(.literal .text)
    _text_end = ABSOLUTE(.);
} >iram0_2_seg
```

The above defines a section called ".flash.text" which includes all the .literal and .text sections from the input and collects them in the memory segment called iram0\_2\_seg.

The content of a section can be specified as follows:

```
<sectionName> : {  
    <fileName>  
    <fileName>  
    ...  
}
```

Input files matching the file name will be placed in this section.

We can also specify:

```
<sectionName> : {  
    <fileName> (section section ...)  
    ...  
}
```

The sections *contained* within the named file will be included in the output section.

Additionally we can specify:

```
<sectionName> : {  
    *(section section ...)  
}
```

Which is a wild card meaning take the sections from **all** input files and include them in the names output section.

We can place a *hole* in the memory map by incrementing the current pointer:

```
. += 64 * 1024;
```

When we are using garbage collection of sections, we can flag data that should be kept even if there are no obvious references to it. We surround the definition of the content with `KEEP()`. For example:

```
KEEP*(.myData)
```

The `ENTRY` part defines the single symbol that is flagged as the entry point of the ELF. For example:

```
ENTRY(my_main)
```

If we run `xtensa-esp32-elf-readelf -file-header` over a built ELF, we can find the entry point. For example:

```
ELF Header:  
Magic:   7f 45 4c 46 01 01 01 00 00 00 00 00 00 00 00  
Class:                               ELF32  
Data:                                   2's complement, little endian
```

```

Version:                1 (current)
OS/ABI:                 UNIX - System V
ABI Version:            0
Type:                   EXEC (Executable file)
Machine:                Tensilica Xtensa Processor
Version:                0x1
Entry point address: 0x401d00b8
Start of program headers: 52 (bytes into file)
Start of section headers: 184780 (bytes into file)
Flags:                  0x300
Size of this header:     52 (bytes)
Size of program headers: 32 (bytes)
Number of program headers: 3
Size of section headers: 40 (bytes)
Number of section headers: 52
Section header string table index: 49

```

We can provide symbols using the syntax:

```
PROVIDE(symbol = address);
```

For example:

```
PROVIDE( abort = 0x4000bba4 );
```

See also:

- [ESP-IDF Docs: General Notes about ESP-IDF Programming](#)
- [The ld command \(includes script syntax and descriptions\)](#)
- [Documentation on ld command](#)

### Weak linkage

When a symbol is defined, its default nature is strong. The alternative is that it be *weak*. We can declare a symbol as weak by prefixing its definition with:

```
__attribute__((weak))
```

For example:

```
void __attribute__((weak)) myFunc();
```

or

```
void myFunc() __attribute__((weak));
```

See also:

- [Wikipedia: Weak symbol](#)

## Memory Map

At the highest level, the ESP32 has:

### Embedded memory

- 448KB internal ROM
- 520KB internal SRAM
- 8KB RTC FAST memory
- 8KB RTC SLOW memory

### External memory

- Up to 16MB SPI flash
- Up to 8MB SPI SRAM

Embedded memory is both ROM and RAM that is inherent inside the ESP32 IC.

External memory is flash and SRAM that exists outside the ESP32 IC.

The external memory can be *mapped* to different address spaces using an MMU. It can also be cached for quick access.

From	To	Size	Bus Type
0x0000 0000	0x3FFF FFFF	1GB	Data bus
0x4000 0000	0x4FFF FFFF	256MB	Instruction
0x5000 0000	0xFFFF FFFF	2.816GB	Data / Instruction

Of this external memory map, it is further broken down into:

Target	From	To	Size	Bus Type
	0x0000 0000	0x3F3F FFFF		Reserved
External Memory	0x3F40 0000	0x3F7F FFFF	4MB	Data / Flash
External Memory	0x3F80 0000	0x3FBF FFFF	4MB	Data / SRAM
Reserved	0x3FC0 0000	0x3FEF FFFF	3MB	
Peripheral	0x3FF0 0000	0x3FF7 FFFF	512KB	Data
Embedded Memory	0x3FF8 0000	0x3FFF FFFF	512KB	Data
Embedded Memory	0x4000 0000	0x400C 1FFF	776KB	Instruction
External Memory	0x400C 2000	0x40BF FFFF	11512KB	Instruction / Flash
Reserved	0x40C0 0000	0x4FFF FFFF	244MB	
Embedded Memory	0x5000 0000	0x5000 0000	8KB	Data / Instruction
Reserved	0x5000 2000	0xFFFF FFFF		

### Embedded Memory sizes and types

Type	Sub type	Size	Range	Size	
Internal ROM 0	ROM 0	384K	0x4000 0000 - 0x4000 7FFF	32K	
			0x4000 8000 - 0x4005 FFFF	352K	iram0_0_seg
	ROM 1	64K	0x3FF9 0000 - 0x3FF9 FFFF	64K	
Internal SRAM	SRAM 0	192K	0x4007 0000 - 0x4007 FFFF	64K Cache	
			0x4008 0000 - 0x4009 FFFF	128K	
	SRAM 1	128K	0x3FFE 0000 - 0x3FFF FFFF	128K	
			0x400A 0000 - 0x400A FFFF	64K	
			0x400B 0000 - 0x400B 7FFF	32K	
			0x400B 8000 - 0x400B FFFF	32K	
	SRAM 2	200K	0x3FFA E000 - 0x3FFD FFFF	200K	
RTC Fast		8K	0x400C 0000 - 0x400C 1FFF	8K	
RTC Slow		8K	0x5000 0000 - 0x5000 1FFF	8K	

### Key

Color	Description
Yellow	Instruction bus
Blue	Data bus
Green	Instruction / Data bus

This is then further broken out (Embedded Memory) into:



Target	From	To	Size	Bus Type
RTC Fast	0x3FF8 0000	0x3FF8 1FFF	8KB	Data
Reserved	0x3FF8 2000	0x3FF8 FFFF	56KB	
Internal ROM 1	0x3FF9 0000	0x3FF9 FFFF	64KB	Data
Reserved	0x3FFA 0000	0x3FFA DFFF	56KB	
Internal SRAM 2	0x3FFA E000	0x3FFD FFFF	200KB	Data
Internal SRAM 1	0x3FFE 0000	0x3FFF FFFF	128KB	Data
Internal ROM 0	0x4000 0000	0x4000 7FFF	32KB	Instruction
Internal ROM 0	0x4000 8000	0x4005 FFFF	352KB	Instruction
Reserved	0x4006 0000	0x4006 FFFF	64KB	
Internal SRAM 0	0x4007 0000	0x4007 FFFF	64KB	Instruction (Cache)
Internal SRAM 0	0x4008 0000	0x4009 FFFF	128KB	Instruction
Internal SRAM 1	0x400A 0000	0x400A FFFF	64KB	Instruction
Internal SRAM 1	0x400B 0000	0x400B 7FFF	32KB	Instruction
Internal SRAM 1	0x400B 8000	0x400B FFFF	32KB	Instruction
RTC FAST Memory	0x400C 0000	0x400C 1FFF	8KB	Instruction
RTC SLOW Memory	0x5000 0000	0x5000 1FFF	8KB	Data / Instruction

Now let us combine the two tables:

Target	From	To	Size	Bus Type	Segment
Reserved	0x0000 0000	0x3F3F FFFF		Reserved	
External Memory	0x3F40 0000	0x3F7F FFFF	4MB	Data / Flash	drom0_0_seg
External Memory	0x3F80 0000	0x3FBF FFFF	4MB	Data / SRAM	
Reserved	0x3FC0 0000	0x3FEF FFFF	3MB		
Peripheral	0x3FF0 0000	0x3FF7 FFFF	512KB	Data	
Embedded Memory	0x3FF8 0000	0x3FFF FFFF	512KB	Data	
RTC Fast	0x3FF8 0000	0x3FF8 1FFF	8KB	Data	
Reserved	0x3FF8 2000	0x3FF8 FFFF	56KB		
Internal ROM 1	0x3FF9 0000	0x3FF9 FFFF	64KB	Data	
Reserved	0x3FFA 0000	0x3FFA DFFF	56KB		
Internal SRAM 2	0x3FFA E000	0x3FFD FFFF	200KB	Data	dram0_0_seg
Internal SRAM 1	0x3FFE 0000	0x3FFF FFFF	128KB	Data	
Embedded Memory	0x4000 0000	0x400C 1FFF	776KB	Instruction	
Internal ROM 0	0x4000 8000	0x4005 FFFF	352KB	Instruction	
Reserved	0x4006 0000	0x4006 FFFF	64KB		
Internal SRAM 0	0x4007 0000	0x4007 FFFF	64KB	Instruction (Cache)	
Internal SRAM 0	0x4008 0000	0x4009 FFFF	128KB	Instruction	iram0_0_seg
Internal SRAM 1	0x400A 0000	0x400A FFFF	64KB	Instruction	
Internal SRAM 1	0x400B 0000	0x400B 7FFF	32KB	Instruction	
Internal SRAM 1	0x400B 8000	0x400B FFFF	32KB	Instruction	
RTC FAST Memory	0x400C 0000	0x400C 1FFF	8KB	Instruction	rtc_iram_seg
External Memory	0x400C 2000	0x40BF FFFF	11512KB	Instruction / Flash	iram0_2_seg
Reserved	0x40C0 0000	0x4FFF FFFF	244MB		
RTC SLOW Memory	0x5000 0000	0x5000 1FFF	8KB	Data / Instruction	rtc_slow_seg
Reserved	0x5000 2000	0xFFFF FFFF			

## Key

Color	Description
	Instruction bus
	Data bus

Now let us examine a compiled and stripped binary build through the ESP-IDF. If we then run `xtensa-esp32-elf-objdump -all-headers` over the file, we get the following:

```
app-template.elf:      file format elf32-xtensa-le
app-template.elf
architecture: xtensa, flags 0x00000102:
```

```
EXEC_P, D_PAGED
start address 0x40080cc4
```

Xtensa header:

```
Machine      = Base
Insn tables = true
Literal tables = true
```

Program Header:

```
LOAD off 0x00000000 vaddr 0x3f3fff40 paddr 0x3f3fff40 align 2**0
  filesz 0x00003cd4 memsz 0x00003cd4 flags r--
LOAD off 0x00003cd4 vaddr 0x3ffb0000 paddr 0x3ffb0000 align 2**0
  filesz 0x00001714 memsz 0x00001714 flags rw-
LOAD off 0x000053e8 vaddr 0x3ffb1718 paddr 0x3ffb1718 align 2**0
  filesz 0x00000000 memsz 0x00000720 flags rw-
LOAD off 0x000053e8 vaddr 0x40080000 paddr 0x40080000 align 2**0
  filesz 0x00007dec memsz 0x00007dec flags r-x
LOAD off 0x0000d1d4 vaddr 0x400d0018 paddr 0x400d0018 align 2**0
  filesz 0x00011110 memsz 0x00011110 flags r-x
```

Sections:

Idx	Name	Size	VMA	LMA	File off	Algn
0	.rtc.text	00000000	400c0000	400c0000	0001e2e4	2**0
		CONTENTS				
1	.iram0.vectors	00000400	40080000	40080000	000053e8	2**2
		CONTENTS, ALLOC, LOAD, READONLY, CODE				
2	.iram0.text	000079ec	40080400	40080400	000057e8	2**2
		CONTENTS, ALLOC, LOAD, READONLY, CODE				
3	.dram0.data	00001714	3ffb0000	3ffb0000	00003cd4	2**4
		CONTENTS, ALLOC, LOAD, DATA				
4	.dram0.bss	00000720	3ffb1718	3ffb1718	000053e8	2**3
		ALLOC				
5	.flash.rodatab	00003bf4	3f400020	3f400020	000000e0	2**4
		CONTENTS, ALLOC, LOAD, READONLY, DATA				
6	.flash.text	00011110	400d0018	400d0018	0000d1d4	2**2
		CONTENTS, ALLOC, LOAD, READONLY, CODE				
7	.comment	000000f4	00000000	00000000	0001e2e4	2**0
		CONTENTS, READONLY				
8	.xtensa.info	00000038	00000000	00000000	0001e3d8	2**0
		CONTENTS, READONLY				

SYMBOL TABLE:

no symbols

Now let us take this apart and map it.

We find that there are five headers in the program section:

Offset	Vaddr	File size	Memsz	Note
0x0000 0000	0x3F3F FF40	0x3CD4	0x3CD4	External Memory / Data
0x0000 3CD4	0x3FFB 0000	0x1714	0x1714	SRAM 2 / Data
0x0000 53E8	0x3FFB 1718	0x0000	0x0720	SRAM 1 / Data
0x0000 53E8	0x4008 0000	0x7DEC	0x7DEC	SRAM 0 / Instruction
0x0000 D1D4	0x400D 0018	0x1 1110	0x1 1110	External Memory / Instruction

And in the sections

Name	Vaddr	Size	Note
.rtc.text	0x400c 0000	0x0000	
.iram0.vectors	0x4008 0000	0x0400	SRAM 0 / Instruction
.iram0.text	0x4008 0400	0x793c	SRAM 0 / Instruction
.dram0.data	0x3FFB 0000	0x1714	SRAM 2 / Data
.dram0.bss	0x3FFB 1718	0x0720	SRAM 1 / Data
.flash.rodata	0x3F40 0020	0x3BF4	External Memory / Data
.flash.text	0x400D 0018	0x1 1110	External Memory / Instruction
.comment	0x0000 0000	0x00F4	
.xtensa.info	0x0000 0000	0x0038	

The linked .ld file called `esp32.ld` defines the MEMORY command for linkage. Specifically, it defines

Name	Start	End	Length
iram0_0_seg	0x4008 0000	0x400B FFFF	128K
iram0_2_seg	0x400D 0018	0x403F FFFF	3MB
dram0_0_seg	0x3FFB 0000	0x3FFD C200	43K
drom0_0_seg	0x3F40 0018	0x3FFF FFFF	4MB
rtc_iram_seg	0x400C 0000	0x400C 2000	8K
rtc_slow_seg	0x5000 0000	0x5000 1000	4K

Combining some information from these tables, we then end up with:

Name	Vaddr	Size	Linker	Note
.rtc.text	0x400c 0000	0x0000		
.iram0.vectors	0x4008 0000	0x0400	iram0_0_seg	SRAM 0 / Instruction
.iram0.text	0x4008 0400	0x793c	iram0_0_seg	SRAM 0 / Instruction
.dram0.data	0x3FFB 0000	0x1714	dram0_0_seg	SRAM 2 / Data
.dram0.bss	0x3FFB 1718	0x0720	dram0_0_seg	SRAM 1 / Data
.flash.rodata	0x3F40 0020	0x3BF4	drom0_0_seg	External Memory / Data
.flash.text	0x400D 0018	0x1 1110	iram0_2_seg	External Memory / Instruction
.comment	0x0000 0000	0x00F4		
.xtensa.info	0x0000 0000	0x0038		

## Dynamic linking

If we have an ELF that provides symbols, we can parse that ELF to find the addresses of those symbols. For example:

```
$ xtensa-esp32-elf-nm -g myElf.elf
```

Will generate data such as:

```
40086d70 T abort
40056340 A abs
3f400ca0 D __action_table
400e0e78 T __adddf3
400dd69c T __any_on
```

The first column is the address in VMA, the second column is the type of symbol and the third column is the name of the symbol. We can process this output using a stream processor to re-write it. For example, the following generates linker script:

```
$ xtensa-esp32-elf-nm -g app-template.elf | sed -E 's/(.*) . (.*)/PROVIDE(\2 = 0x\1);/'
```

generates

```
PROVIDE(abort = 0x40086d70)
PROVIDE(abs = 0x40056340)
PROVIDE(__action_table = 0x3f400ca0)
PROVIDE(__adddf3 = 0x400e0e78)
PROVIDE(__any_on = 0x400dd69c)
...
```

Let us imagine that we have two source files. Let us call the first one `IDF.c` and the other `APP.c`. If we compile `IDF.c` to produce the binary `IDF.elf` we can then ask this file for all the symbols it exports along with their memory addresses. If we then compile `APP.c` to produce `APP.elf`, we may find that we have unresolveds. If the unresolveds can be located in the symbols exported from `IDF.elf`, we could link `IDF.elf` together with `APP.elf` to produce a new single binary file that is the aggregate of both. The resulting combined file size would be the sum of both `APP.elf` and `IDF.elf`. Can we produce a runnable `APP.elf` that would keep its small size but yet still be executable? The answer is yes. To achieve that goal, we work on the notion that `IDF.elf` will be in memory and distinct from `APP.elf`. We can tell `APP.elf` that the symbols it wants that are unresolved are available to it and can be sourced in memory from the loaded `IDF.elf`. Many operating systems are able to perform this task at runtime through the function variously known as shared libraries and dynamic link libraries. While it may be theoretically possible to achieve this high level technique within the ESP-IDF environment, it hasn't been seen in the wild (yet). However, another possibility is to link `APP.elf` with a *linker script* that instructs the linker where in memory it can find symbols

which need resolved without *actually* merging in the code that implements those symbols. We can achieve this through the linker script `PROVIDE` directive. Using that directive we can name a symbol and its value that will then be used for symbol resolution. If we run a tool over `IDF.elf` to generate a suitable linker script that exposes all the symbols we may need, we can then link `APP.elf` with the generated script and the resulting binary for `APP.elf` will be ready to run.

This is illustrated in the following diagram. We have the `IDF.elf` which exposes a function called `funcX()`. In our `APP.elf` we have a function called `funcY()` which invokes `funcX()`. If we were to compile and link `APP.elf` by itself, it would fail with an unresolved of `funcX()`. However, if we compile `APP.elf` and at link time provide it a linker script that declares that `funcX()` can be found at a given memory address, all will then be well.

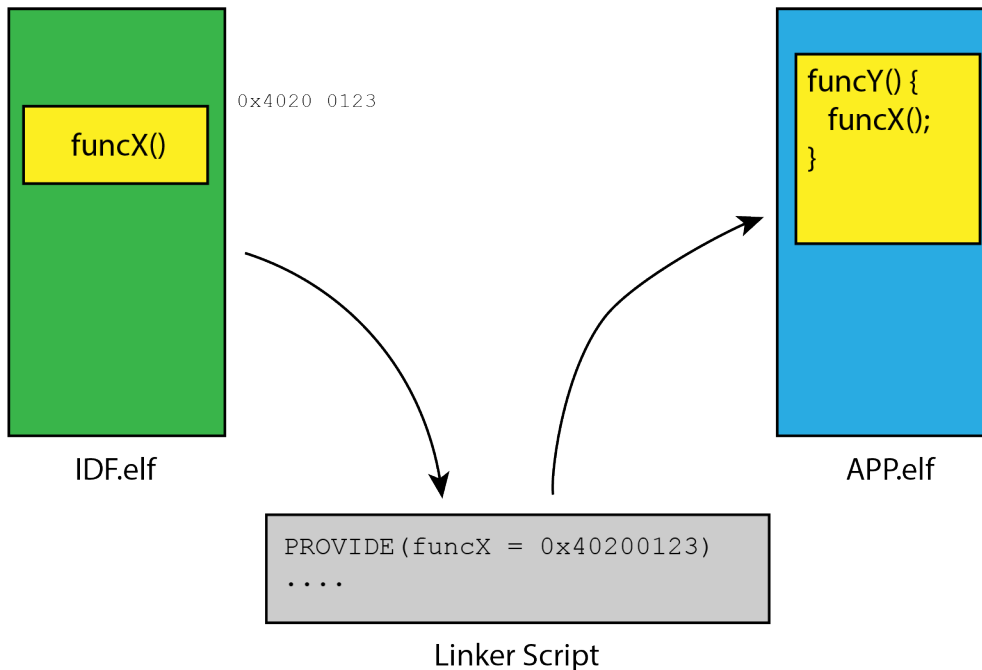

When an ESP32 boots, it is happy to load and run an executable that has been built and stored in flash memory. The ESP32 maps that application into address memory, initializes it and then branches to its entry point. From there on, the application can be considered running. However, the ESP-IDF has no inherent knowledge of the story we of separate applications so the work to run this environment falls to us. Let us assume that the application we have been calling `IDF.elf` is a normal/standard ESP-IDF application and loads and runs as usual. In that story, it would then be the responsibility of the `IDF.elf` to dynamically load, initialize and call `APP.elf`. While this sounds quite easy on the surface, it hides a wealth of puzzles underneath. Fortunately all of them are resolvable.

If we take `APP.elf` apart, we will find that it is composed of a variety of components each of which need to be considered separately. When we compile and link an application, the internal parts of that application can be placed in separate buckets based on their nature. We can identify and examine those parts and will do so now.

First there is the `.text` part. This is the generated binary executable code that is built from the source statements that you coded. Assuming you write in C, those statements are translated to assembler and then passed to the assembler for translation into binary code.

Next there is static but initialized data. This is data that is global in your application and has an initial value. As an example:

```
int myInt = 123;
char *name = "Neil";

void myFunc() {
    ...
}
```

Here the variable called `"myInt"` needs storage reserved for it and it be initialized to the value of `123`. Similarly for the variable called `"name"`. These items are placed in a bucket called `.data`.

Next there is data that is global but un-initialized.

```
int myInt;
```

While similar to the previously initialized data in that storage needs to be reserved, the value of that data is not defined and has an initial value of zeros. These items are placed in a bucket called `.bss`.

Finally, there is constant data doesn't change its value. For example:

```
const int myInt = 123;
```

This kind of data is placed in the bucket called `.rodata` (read only data).

So far we have been loosely talking about buckets but how do these manifest in our real ESP32 environment? The bucket is a way of grouping together items that have some logical relationship and the relationship we are discussing here is where in memory they should end up. When we compile and link code to produce an ELF formatted binary, the parts that constitute the internals are tagged. These tag parts are what we use to group them together. We will find tags called `.text`, `.data` and `.bss` (amongst others). As the linker does its job, it has a model of where in memory the start of `.text`, the start of `.data` and the start of `.bss` should begin. It then walks through all the pieces in the ELF and, based on the tag of the piece, starts building a map of where within the final

memory each piece should be placed to ensure that they don't overlap with each other and compactly use memory. At the end of the linkage phase, each of the pieces will have an actual memory address associated with them which is where the piece can be found at run-time in the memory address space.

Each of the sections will be stored contiguously within the system binary file that will be stored in flash. We need to map the sections into their correct places within the address space.

The `.text` section will be mapped from flash directly into the instruction portion of the address space using the Memory Mapping Unit (MMU). This means that a reference to an instruction in instruction memory will be transparently mapped to a flash access.

The contents of the `.data` section will be copied from flash into its final destination in data address space in RAM. Finally, address space corresponding to the `.bss` section will be set to binary zeros.

There is one further puzzle we must first solve and that is what addresses to tell the linker to use to allocate starting addresses for our `APP.elf`. We will split our puzzle into two halves ... the first will be executable addresses and the second will be data addresses.

In the ESP32, executable code is generated starting from the segment called `iram0_2_seg` on-wards. If we look inside the ESP-IDF provided file called `esp32.ld`, we find this set to `0x400D 0000` for `0x33 0000` which is 3,342,336 bytes which is a little over 3MBytes. Pictorially, this is:

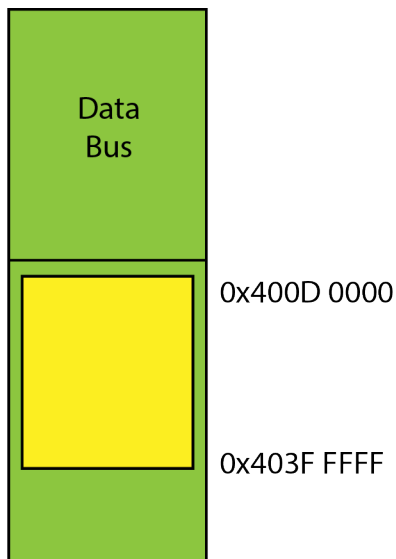

Based on what we have said already, the `IDF.elf` and the `APP.elf` will *both* be located in memory. If we say that `IDF.elf` will load first and then the `APP.elf`, we end up with a story that looks like:



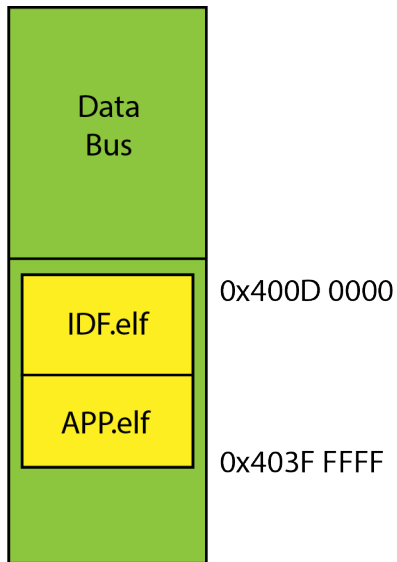

The `.text` for `APP.elf` will thus start somewhere after the end of `IDF.elf`. Because of MMU requirements, the start of `APP.elf` must begin at a 64K boundary.

Next let us consider the placement of `.data` and `.bss`. These will be found in the data address space starting at `dram0_0_seg` which is `0x3FFB 0000` for `0x2 c200` which is 180736 bytes.

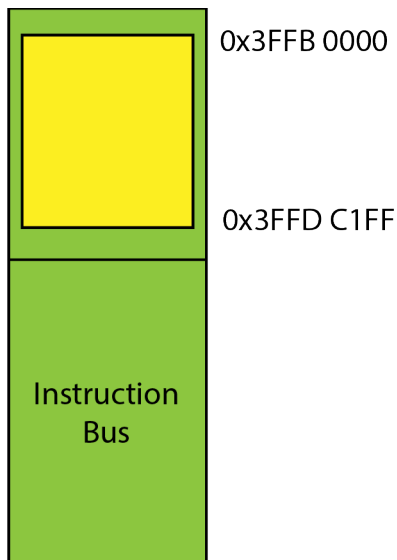

Things are a little bit trickier here. When the ESP32 loads its initial app (in our example, `IDF.elf`), the RAM that is allocated is immediately followed by the start of the heap. To be precise, the heap starts at the symbol called `_heap_start` which defaults to just after the last of `.bss` from the loaded app. If we think this through, we will find that the loading of `IDF.elf` accounts for 100% of RAM usage. The RAM needed for the app's

`.data` and `.bss` sections will be reserved and then **all** the remaining RAM will be given over to the heap. While this is normally just fine for the execution of an application, it gives us problems when we consider our desire to load two apps. If 100% of RAM is accounted for, there is no further RAM available for holding the `.data` and `.bss` sections from the `APP.elf`. What we need to do is reserve sufficient RAM that will hold the largest `APP.elf` RAM that we wish to support and define that for the `APP.elf` base RAM start address. Once the `APP.elf` RAM needs are satisfied, we will then find that if there is remaining RAM, we can hand that back to the heap for subsequent allocation as requested. We can envisage this as a series of utilizations of RAM over time:

First we imagine us loading the `IDF.elf` data into RAM. We choose to start this at the start of RAM **plus** 64K.

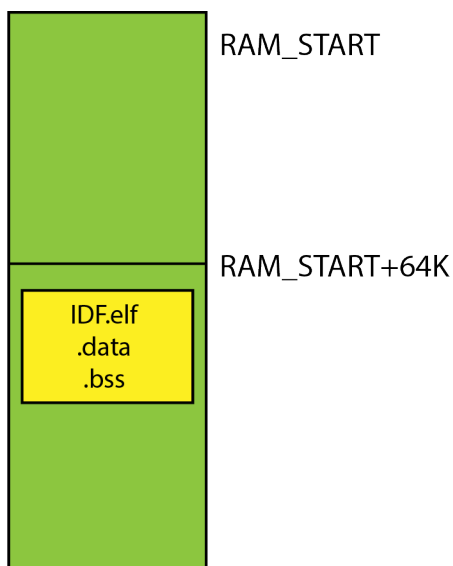

Once the `IDF.elf` app has been loaded, the remaining data *after* the end of `IDF.elf` is taken / owned by the heap:

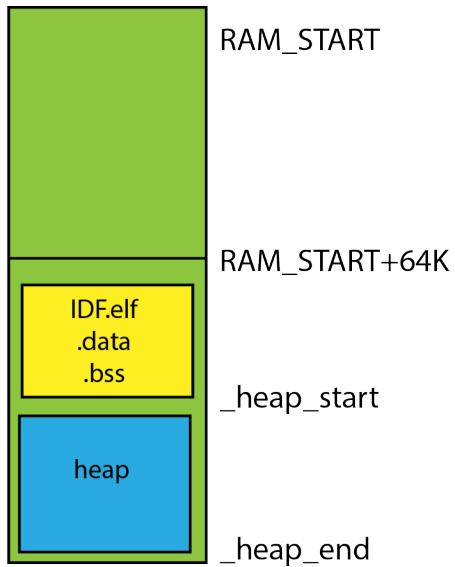

Now we load the `APP.elf` data portions at the start of RAM in the hole we allocated for this.

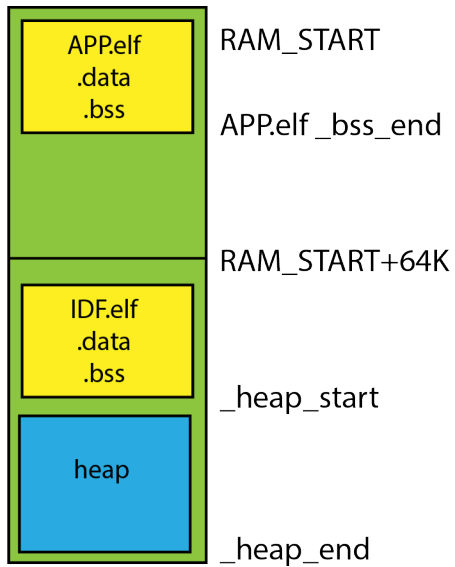

Finally the area of unused storage following the end of the data needed for `APP.elf` to the beginning of data for `IDF.elf` is explicitly given over to the heap manager:

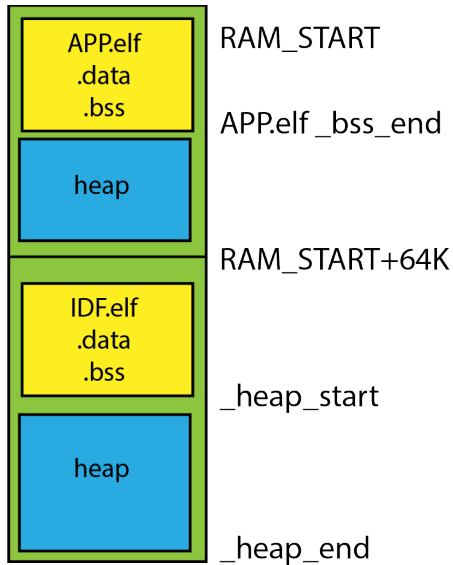

The addresses of the data to be added to the heap are from `_bss_end` as found in `APP.elf` to `RAM_START + 64K`.

Finally we have achieved our goal. We have both the `IDF.elf` and `APP.elf` data portions in memory with all the otherwise unused available RAM given over to the heap.

To punch a 64K hole in the data section, we need to edit the linker script provided by ESP-IDF called `components/esp32/ld/esp32.common.ld`. This contains a section definition called `.dram0.data`. The change we want to make is:

```
.dram0.data :
{
    _data_start = ABSOLUTE(.);
    . += 64 * 1024;
    *(.data)
    ...
}
```

This will add a 64K hole into the RAM allocation the start of which which can be found at `_data_start`.

Experience is showing that the resulting address of `_data_start` is `0x3FFB 0000`.

The `.text` will also need to be mapped. Let us choose 3MBytes into the first 4MByte address range for instruction bus as the location into which the text will be loaded. Since we see that the start of instruction bus is at `0x4000 0000` and 3MBytes is `0x30 0000` then the start of `.text` for our `APP.elf` will be `0x4030 0000`.

The `.flash.rodata` must also be mapped. This is data that will be read only and be mapped from flash to memory. The memory address range for `.rodata` for the ESP32 as a whole is `0x3F40 0000` to `0x3f80 0000` which is 4MBytes. In our solution, we will use `0x3F60 0000` as the starting address for `APP.elf .rodata`.

If we assume that we have built an image binary called `userApp.bin`, we need to copy that into the flash memory of the ESP32. We can use `esptool` for this task:

```
python $IDF_PATH/components/esptool_py/esptool/esptool.py \  
  --port $ESPPORT \  
  --baud $ESPBAUD \  
  --chip esp32 \  
  --before default_reset \  
  --after hard_reset write_flash \  
  -u \  
  --flash_mode dio \  
  --flash_freq 40m \  
  --flash_size detect \  
  0x300000 userApp.bin
```

Now we need a recipe to compile user applications. Let us take a sample user application as a test.

```
#include <stdio.h>  
void user_app() {  
    printf("User app called!\n");  
}
```

If we write our own compilation and linkage, we end up with an ELF that contains no unresolveds.

```
$ xtensa-esp32-elf-nm -u APP.elf  
$
```

After having built the `APP.elf`, we need to prepare it for writing to the flash memory of the ESP32. In theory, we could write the ELF binary exactly as it is however, the ELF format contains more information than we actually need for our purposes. What we want to do is re-write the ELF into an image file that contains only the information we will use. The `esptool` is able to perform this task for us using the `elf2image` sub-command.

We can pass control to our `user_app()` entry point and it will run our desired code however the environment is not yet perfect. While we have indeed copied into initialized data, we have not zeroed the un-initialized data (`.bss`).

Imagine the following code fragment:

```
static char buffer[100];  
static int count;  
void user_app() {  
    // code here  
}
```

Within our `user_app()` code, we *should* find that the bytes contained in `buffer` are all zeros and the value of `count` is also 0. Unfortunately, that isn't assured. Nowhere in our logic have we made that happen. What we have to do is explicitly set the storage for un-initialized data to be zeros. When we link a `APP.elf`, we will find that two symbols are created. These are `_bss_start` and `_bss_end`. These are the start and end of the un-initialized data and must be explicitly zeroed. We can achieve that task with:

```
memset(&_bss_start, 0, &_bss_end-&_bss_start);
```

However, this must be called within the `APP.elf` environment as only it will have the correct values for the symbols.

See also:

- [Github: nicoooo/esp32-elfloader](#)

### Section garbage collection

If we imagine sections/symbols that are simply unused in our application, it seems to make sense that we should simply prune those at linkage time. For example, if we have an object file that contains a function exposed as `foo()` and nothing in our application logic actually calls this function, then including it in the resulting executable would be wasteful. If it were simply not present in the binary, the binary would be smaller and would still execute correctly. When we link all of our object files together to produce an executable, this would be the time to find and remove unused function. In our dynamic linking story, this becomes a problem. If our `IDF.elf` binary contains an ESP-IDF exposed function that we want to call from our `APP.elf`, when we link `IDF.elf` it knows nothing of `APP.elf` and can discard the code/symbol thinking that since nothing locally is dependent on it then it is free game for purging.

Linker flags that affect garbage collection are:

- `--gc-sections`
- `--no-gc-sections`
- `--print-gc-sections`
- `--no-print-gc-sections`
- `--gc-keep-exported`

One of the more promising capabilities of the linker that we can use is the "`-u symbol`" flag. This forces the named symbol to be referenced as undefined and require it to be resolved in the output. See also the linker script `EXTERN` command.

See also:

- [ld documentation – Input Section and Garbage Collection](#)

## C++ class initialization

Consider a C++ class that we are using in our `APP.elf`. For example:

```
class MyClass {
private:
    int count;
public:
    MyClass() {
        count = 123;
    }
    void myFunc() {
        printf("The value of count is: %d\n", count);
    }
}

MyClass myInstance;

void user_app() {
    myInstance.myFunc();
}
```

If we run this code we should expect the value of `count` to be logged as `123`. However, if we were to run this in our dynamic linking story, it would not. The reason is that the variable called `myInstance` is an instance of `MyClass` and `MyClass` has a constructor function which needs to be executed for `myInstance` to be correct. This means that not only do we have to load `APP.elf` into memory, we must arrange for any class constructors to be invoked. The linker system arranges for an array of constructor functions to be created. In our environment, this is the set of functions between `__init_array_start` and `__init_array_end`. For each of the functions pointed to by these array entries, we can invoke them and the result will be the proper constructor initialization.

Here is a code fragment that will achieve this for us:

```
uint32_t *p = (uint32_t *)&__init_array_start;
while(p != &__init_array_end) {
    ((void (*)()) (*p)) ();
    p++;
}
```

See also:

- [How initialization functions are handled](#)

## The Bootloader

The bootloader is one of the first ESP32 modules invoked and is responsible for bringing up the majority of the remainder of the system. There is a ROM based first-

stage bootloader which will load the second stage bootloader from flash memory at flash address offset 0x1000.

A binary image is kept in flash and used to direct the operations. It begins with a header of type

`esp_image_header_t` (`components/bootloader_support/include/esp_image_format.h`) that contains:

Field	Description
<code>uint8_t magic</code>	The value defined in the constant <code>ESP_IMAGE_HEADER_MAGIC</code> which is currently <code>0xE9</code> .
<code>uint8_t segment_count</code>	The number of segments.
<code>uint8_t spi_mode</code>	
<code>uint8_t spi_speed:4</code>	
<code>uint8_t spi_size:4</code>	
<code>uint32_t entry_addr</code>	Seen to be the entry address shown in <code>objdump</code> .
<code>uint8_t wp_pin</code>	
<code>uint8_t spi_pin_drv[3]</code>	
<code>uint8_t reserved[11]</code>	
<code>uint8_t hashAppended</code>	

`esp_image_metadata_t` that contains:

Field	Description
<code>uint32_t startAddr</code>	Address of start of data
<code>esp_image_header_t image</code>	
<code>esp_image_segment_header_t segments[]</code>	Segment headers
<code>uint32_t segment_data[]</code>	Address of start of data
<code>uint32_t image_len</code>	

`esp_image_segment_header_t` that contains:

Field	Description
<code>uint32_t load_addr</code>	The virtual memory address where the data should reside. Examination of this value will tell us where the data should go. <ul style="list-style-type: none"> <li>• <code>0x3F40 0000 &lt;= value &lt; 0x3F80 0000</code> – MMU mapping</li> <li>• <code>0x4000 0000 &lt;= value &lt; 0x40C0 0000</code> – MMU mapping</li> <li>• <code>value = 0x0000 0000</code> – Not mapped</li> <li>• otherwise special handling such as data copies into RAM.</li> </ul>
<code>uint32_t data_len</code>	The length of the data.



The binary image file contains:

Content	Count
esp_image_header_t	1
esp_image_segment_header_t	1
segment data	1
esp_image_segment_header_t	1
segment data	1
...	

The bootloader source is contained in

components/bootloader/subproject/main/bootloader\_start.c

The primary entry point is `bootloader_main()` which performs:

```
bootloader_main() {
    esp_image_metadata_t image_data;

    load_boot_image(&image_data);
    unpack_load_app(&image_data);
}

load_boot_image() {
    try_load_partition();
}

try_load_partition() {
    esp_image_load();
}

esp_image_load(esp_image_metadata_t *data) {
    data->start_addr = partition start address;
    copy data->start_addr -> data->image for sizeof_esp_image_header_t
    //bootloader_flash_read()
    for each of the segments {
        process_segment()
    }
}

unpack_load_app() {
    set_cache_and_start_app()
}

set_cache_and_start_app() {
    // Multiple
    cache_flash_mmu_set(...);
    Call the entry point of the application;
}
```

A C program was written to dump/examine the content of the .bin files. For an example bin it shows the following:

```
Dump of ESP32 binary file: app-template.bin
magic: 0xe9, segment_count: 7, entry_addr: 0x40080cc4 - Internal SRAM 0 (128K)
```

Seg	Start	End	Length	Area
0	0x3f400020	0x3f403c14	15348 (0x003bf4)	External Memory (Data)
1	0x3ffb0000	0x3ffb1714	5908 (0x001714)	Internal SRAM 2 (200K)
2	0x40080000	0x40080400	1024 (0x000400)	Internal SRAM 0 (128K)
3	0x40080400	0x40087dec	31212 (0x0079ec)	Internal SRAM 0 (128K)
4	0x400c0000	0x400c0000	0 (0x000000)	RTC FAST Memory (8K)
5	0x00000000	0x00002ed4	11988 (0x002ed4)	Un-described
6	0x400d0018	0x400e1128	69904 (0x011110)	External Memory (Instruction)

The source of this program is part of esp32-snippets in `tools/bootloaderExamine`.

## Runtime memory

```
extern int _bss_start;
extern int _bss_end;
extern int _data_start;
extern int _data_end;
extern int _rodata_start;
extern int _rodata_end;
extern int _heap_start;
extern int _heap_end;
extern int _text_start;
extern int _text_end;
```

The linked file for the bootloader defines symbols called

- `_bss_start` – Address of the start of bss
- `_bss_end` – Address of the end of bss
- `_data_start` – Address of the start of data
- `_data_end` – Address of the end of data

Thoughts:

```
_bss_end = _heap_start
```

Doing some tests we find:

```
Text:          0x400d1d7c

New malloc 1:  0x3ffb4e68
Static data 1: 0x3ffb1fa4
Local data 1:  0x3ffb3ba0
Const data 1:  0x3f402649

New malloc 2:  0x3ffb526c
Static data 2: 0x3ffb1ba4
Local data 2:  0x3ffb3ba1
Const data 2:  0x3f402648
```

Malloc grows upwards ...?

Static data grows downwards ...?

Local data grows upwards ...?

Questions:

Where shall we put:

- roData?
- data?
- bssData?
- text?

See also:

- Memory Map
- Working with memory
- Memory mapping and address spaces

**Cache memory processing**

Cache\_Read\_Disable()

Cache\_Flush()

mmu\_init()

DPORT\_REG\_SET\_BIT

DPORT\_REG\_CLR\_BIT

DPORT\_PRO\_FLASH\_MMU\_TABLE

cache\_flash\_mmu\_set

## Cache\_Read\_Enable()

### MMU processing

If we boot an ESP32 with bootstrap diagnostics enabled, we will find messages similar to the following:

```
D (522) boot: calling set_cache_and_start_app
D (527) boot: configure drom and irom and start
V (532) boot: d mmu set paddr=00020000 vaddr=400d0000 size=70724 n=2
V (542) boot: i mmu set paddr=00010000 vaddr=3f400000 size=15780 n=1
```

The way to interpret the above is that flash data at offset `0x2 0000` is mapped into the address space of the ESP32 to appear at `0x400D 0000`. This is on the instruction bus.

In addition, flash data at offset `0x1 0000` is mapped into the address space of the ESP32 to appear at `0x3F40 0000`. This is on the data bus.

MMU – Memory Management Unit

MPU – Memory Protection Unit

PID – Process Identifier

First we will discuss external memory only.

Let us assume that we have an offset in flash called `Foffset` and it is 64K aligned. Now imagine we want to map that virtual memory address `VMAx ...` how is that done?

We will limit our discussion to code running in PID 0 or 1.

We introduce the concept of a named region in virtual address space. These regions are:

Region name	Low	High	Notes
VAddr0	0x3F40 0000	0x3F7F FFFF	
VAddr1	0x4000 0000	0x403F FFFF	Flash
VAddr2	0x4040 0000	0x407F FFFF	Flash
VAddr3	0x4080 0000	0x40BF FFFF	Flash
VAddr4	0x3F40 0000	0x3F4F FFFF	Flash
VAddrRam	0x3F80 0000	0x3FBF FFFF	RAM

Looking back at our desired virtual memory location (`VMAx`) it *must* be in on of these regions. Given its address, we can now determine which corresponding region it is in.

Now we have a second mapping table which maps a region to the start of MMU mapping entry (there are 256 mapping entries for flash ... each one mapping a virtual machine address to a flash 64K page).

The start of the mapping entry for each region is:

Region name	Start entry number
VAddr0	0
VAddr1	64
VAddr2	128
VAddr3	192

Given an address, we can now determine which mapping entry we are interested in working with.

Start VMA	End VMA	MMU entries number	Bus
0x3F40 0000	0x3F40 FFFF	0	Data
0x3F41 0000	0x3F41 FFFF	1	Data
...	...	...	Data
0x3F7F 0000	0x3F7F FFFF	63	Data
0x4000 0000	0x4000 FFFF	64	Instruction
0x4001 0000	0x4001 FFFF	65	Instruction
...	...	...	Instruction
0x403F 0000	0x403F FFFF	127	Instruction
0x4040 0000	0x4040 FFFF	128	Instruction
...	...	...	Instruction
0x407F 0000	0x407F FFFF	191	Instruction
0x4080 0000	0x4080 FFFF	192	Instruction
...	...	...	Instruction
0x40BF 0000	0x40BF FFFF	255	Instruction

Good .... now given an address, we can determine an MMU entry number or, conversely, given an MMU entry number, we can determine an address range.

At the ESP32 hardware level, there is a table called `DPORT_PRO_FLASH_MMU_TABLE`. This table contains 256 entries with each entry being 32 bits in size. It governs the MMU for the PRO CPU. A similar table called `DPORT_APP_FLASH_MMU_TABLE` governs the APP CPU.

Each entry in the table is 32 bits.

Bits	Description
[9-31]	Reserved; must be 0
8	0 = Mapped 1 = Not mapped
[0-7]	Flash page (64K) – 16MB range

If we thus think about our offset in flash, this will be found in the flash page with identity  $Foffset \div (64 \times 1024)$ . Since we now know the flash page and the MMU entity, we can set the corresponding `DPORT_PRO_FLASH_MMU_TABLE` entry to be the page identity in flash.

Examining the ESP32 bootloader code, we see that the bootloader sets MMU to map the desired application and this is achieved with a call to the internal function called `cache_flash_mmu_set()`. This API then calls `cache_flash_mmu_set_rom()`.

The signature of the `cache_flash_mmu_set()` function is:

```
unsigned int cache_flash_mmu_set(
    int cpu_no,           // 0 for PRO cpu, 1 for APP
    int pid,             // PID (0-7)
    unsigned int vaddr,  // virtual address
    unsigned int pAddr,  // physical address
    int pSize,           // Page size (Believed to be in Kbytes)
    int num)             // Number of pages
```

If we look in the source for `spi_flash_mmap_pages` we find that it sets the tables directly but first bracketing the work in calls to:

```
spi_flash_disable_interrupts_caches_and_other_cpu() and
spi_flash_enable_interrupts_caches_and_other_cpu().
```

Be careful when mapping storage to instruction address bus. This only allows reading in units of 32bits. What this means is that if you map to this area and then try and read at byte boundaries we will encounter an exception (`LoadStoreError`). We can only read data from instruction address bus in units of 32bits.

## C++ Programming

### Eclipse configuration

To support the correct indexing of the standard templates, the following incantation is required.

1. Open up the project properties
2. Visit C/C++ General > Preprocessor Include Paths, Macros, etc
3. Select the Providers tab

4. Check the box for "CDT GCC Built-in Compiler Settings"
5. Set the compiler spec command to
 

```
xtensa-esp32-elf-gcc ${FLAGS} -std=gnu++11 -E -P -v -dD "${INPUTS}"
```
6. Rebuild the index

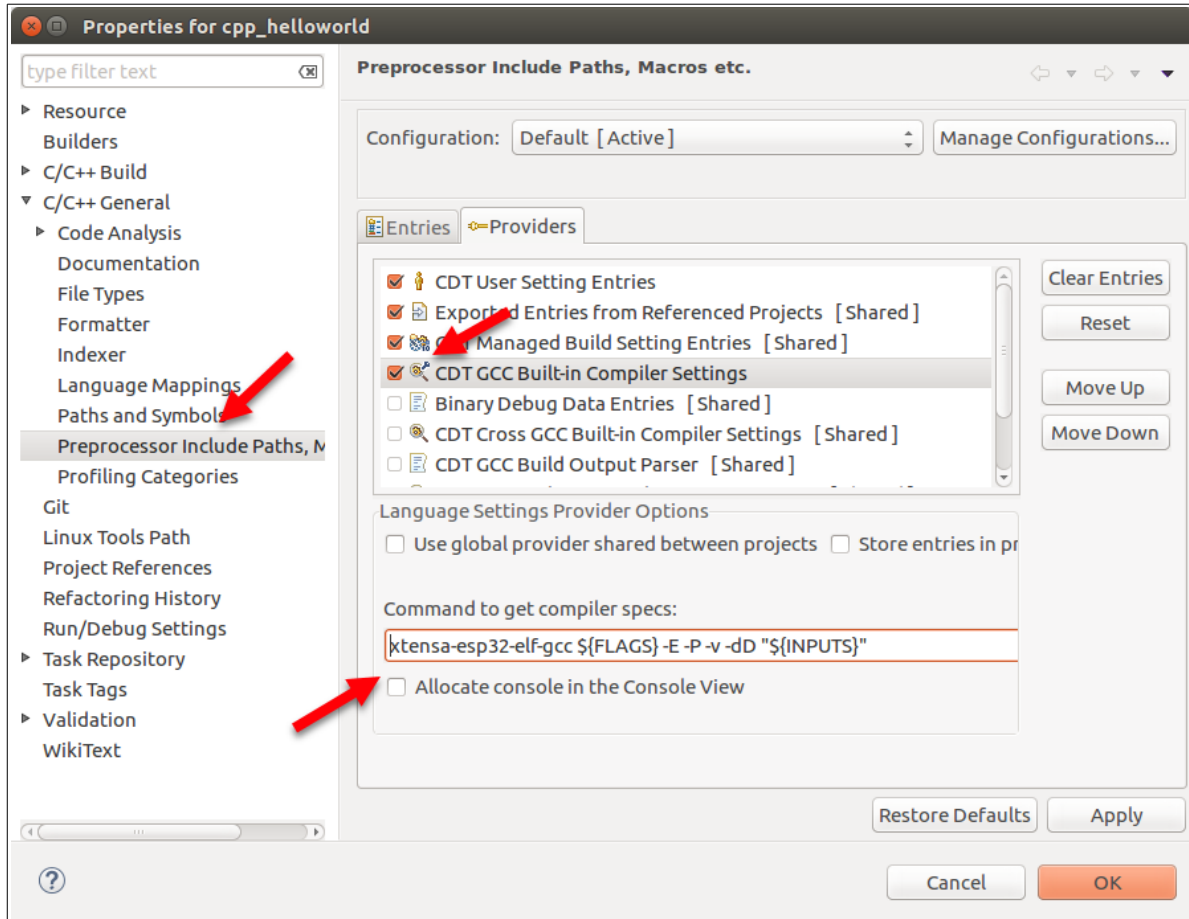

### Simple class definition

Classes are defined using the "class" keyword. Within a class we can define public fields and member functions as well as private fields and member functions. Public items may be accessed directly from outside the class if we have an instance of it. Private items may be accessed only from within the class itself.

A constructor method is a public method having no return type and the same name as the class itself. Should we need to perform some specialized cleanup, we can declare a destructor method that is invoked when the class instance is deleted. The name of the

method is the same as the class but prefixed with the "~" character and has no return type.

Within a class instance methods, we can use a variable called `this` which will be an implicit pointer to the instance of the current class.

If we declare a field within a class definition as being static, then just one copy of the variable is shared across all instances of the class. A method within a class can be defined as static and is thus allowed to be executed without reference to a class instance.

One class can inherit from another using:

```
class newClass: public existingClass {
    ...
}
```

### Sample class header

```
#ifndef MyClass_h
#define MyClass_h

class MyClass {
public:

    MyClass();
    static void myStaticFunc();
    void myFunc();
};
#endif
```

### Sample class source

```
#include <MyClass.h>
MyClass::MyClass() {
    // Constructor code here ...
}
String MyClass::myStaticFunc() {
    // Code here ...
}
void MyClass::myFunc() {
    // Code here ...
}
```

### Mixing C and C++

The vast majority of the ESP-IDF platform is written in C. Should you wish to write C++ applications and leverage the ESP-IDF C functions or, conversely, have ESP-IDF



application logic call your C++ source files there is an important consideration we have to include.

In C, if I define a function, `foo()` for example, then the function is called `foo()` and there is no ambiguity. Now consider a class called `A` which has a function called `foo()` and a second class called `B` which also has a function called `foo()`. It seems pretty obvious that I can't simply call `foo()` as the environment would not know which one was meant. That is why we prefix a function call with the class name in which it was defined. Now let us consider functions declared outside of a class. For example:

```
void bar() {  
    // some code  
}
```

If I coded this in a C++ program, I could then call `bar()` and all would be good. However if then wrote a C source file and tried to call `bar()` we might be surprised to find that the linker would complain that we couldn't find `bar()`. Why is this?

The answer is that when we declare a global function in a C++ source file, the C++ environment implicitly flags the function as being part of a C++ class that represents some global class and, as such, its name is not actually `bar()` but is instead

```
<someGlobalName>::bar().
```

Fortunately, should we wish, we can explicitly declare that a function definition should be defined without a prefix class name by using the syntax:

```
extern "C" {  
    void bar();  
}
```

This results in the exported name of `bar()` without any further decoration.

### Including `stdc++` in your app

The Espressif supplied C++ compiler includes the `stdc++` library. If we wish to use this, we must include it in our linking. The easiest way to do this is to add

```
COMPONENT_ADD_LDFLAGS=-lstdc++ -l$(COMPONENT_NAME)
```

To `component.mk` in the main directory.

## C++ Specialized Data types

### String

The string data type is included through:

```
#include <string>
```

A string can be declared using:

```
std::string myString = "Hello World";
```

Since string is a class, we have objects available on it:

- `length / size` – The length/size of the string in characters.
- `find` – Find a sub-string with the string.
- `empty` – True if the string is empty.
- `clear` – Empty the string.
- `+` – Concatenate to the string.
- `c_str` – Return a null terminated string representation (a C language string).

The string type also has some powerful stream processors associated with it.

There is a class called `std::stringstream` which allows us to stream data into it and then retrieve the string representation. For example:

```
#include <sstream>
std::stringstream stream;
// do stream things
std::string myString = stream.str();
```

We can append into the stream with:

```
stream << "hello " << "world: " << 123;
```

We can also do numeric formatting such as setting the width, fill character and hex mode:

```
#include <iomanip>
stream << std::hex << std::setfill('0') << std::setw(2) << 99;
```

## List

The list data type is included through:

```
#include <list>
std::list<type> myList
```

Some of the more common functions include:

- `front()` - Return a reference to the front element in the list.
- `back()` - Return a reference to the back element in the list.
- `empty()` - Determines if the list is empty.
- `push_back()` - Add an element to the end of the list.

- `push_front()` - Add an element to the start of the list.

## Map

This data type stores name/value pairs.

The map data type is included through:

```
#include <map>
```

We define a map variable using:

```
std::map<keyType, valueType> mapName;
```

To insert a value into the map we use:

```
mapName.insert(std::pair<keyType, valueType>(key, value));
```

To see if a value is within the map, we use:

```
valueType value = mapName.at(key);
```

This will throw a `std::out_of_range` exception if the key is not found in the map.

To iterate through a map we use:

```
for (auto &myPair : mapName) {  
    // myPair.second is the value  
}
```

We can also use a more conventional iterator:

```
for (std::map<keyType, valueType>::iterator it = mapName.begin();  
     it != mapName.end();  
     it++) {  
    // it->first is the key  
    // it->second is the value  
}
```

See also:

- [std::map Tutorial Part 1: Usage Detail with examples](#)

## Queue

The queue data type is included through:

```
#include <queue>
```

## Stack

The stack data type is include through:

```
#include <stack>
```

## Vector

The vector data type is included through:

```
#include <vector>
```

and is part of the "std:" namespace.

```
std::vector<type> myVector;
```

We can access the member's of a vector through the "[x]" array index construct.

We can append to the end of a vector using "push\_back()" and pull from the end using "pop\_back()". The size() method returns the number of entries in the vector. The clear() method removes all entities in the vector. The empty() method returns true if the vector is empty.

We can iterate over a vector using:

```
for (std::vector<type>::iterator it = myVector.begin(); it != myVector.end(); ++it) {  
    // do something with it  
}
```

## Lambda functions

Modern C++ has introduced lambda functions. These are C++ language functions that don't have to be pre-declared but can instead be declared "inline". The functions have no names associated with them but otherwise behave just like other functions.

See also:

- [Lambda functions](#)

## Designated initializers not available in C++

In the latest versions of the C programming language, we can perform interesting structure initializations such as:

```
struct myStruct myVar = {  
    .a = 123;  
    .b = "xyz";  
};
```

This will create an instance of a variable called "myVar" of type "struct myStruct" and initialize its members.

This capability is not present in C++.

## Ignoring warnings

From time to time, your code may issue compilation warnings that you wish to suppress. One way to achieve this is through the use of the C compile `#pragma` directive.

For example:

```
#pragma GCC diagnostic ignored "-Wformat"
```

See also:

- [GCC Diagnostic Pragma](#)

## File I/O in C++

Leveraging STL, we have some nice file I/O capabilities.

```
ofstream myfile;  
myfile.open("<name>");  
myfile << <data>;  
myfile.close();
```

The `open` method has the signature `open(filename, mode)`. The mode can control how the file is opened and is the bitwise or of flags such as:

- `ios::in` – Open for input.
- `ios::out` – Open for output.
- `ios::binary` – Open for binary.
- `ios::ate` – Set the file pointer to the end of the file.
- `ios::app` – Append to the end of the file.
- `ios::trunc` – Truncate the file.

Headers:

- `ofstream` – Output to files.
- `ifstream` – Input from files.
- `fstream` – Input and output from files.
- `iostream`

See also:

- [Input/output with files](#)

## The Factory pattern

In an ESP32 environment there are lots of times where "callbacks" of one form or another are desired. If we were in a C environment, I might do the following:

```
void myCallbackFunc() {
    ... my code;
}

registerCallback(myCallbackFunc);
```

While this will still work in a C++ environment, I really wanted to take advantage of the nature of C++ and write a C++ class that implements my logic. For example:

```
MyClass : public CallbackInterface {
    void callbackFunc() {
    }
}
```

and thus, when the event fires, we would invoke myCallbackClass() method. And this of course would work if we did something like:

```
MyClass *pMyClassInstance = new MyClass();
registerCallback(pMyClassInstance);
```

However, if we look closely, what we see is that we are providing ONE instance of the class. Ideally I want an instance of the class to be created for each event.

We can do this using a factory pattern.

Now imagine we have:

```
class CallbackInterface {
    virtual void callbackFunc() = 0;
}
class CallbackFactory {
    virtual CallbackInterface* newInstance() = 0;
}
MyCallbackClass : public CallbackInterface {
    void callbackFun() {
    }
}
MyCallbackClass Factory : public CallbackFactory {
    MyClassFactory *newInstance() {
        return new MyCallbackClass();
    }
}
```

## Logging pre-defined symbols

The C and C++ compilers have pre-defined symbols within them. We can log those with:

```
$ xtensa-esp32-elf-gcc -dM -E - < /dev/null
```

## The ESP-IDF C++ class libraries

Given the richness of function available in ESP-IDF as well as the power of encapsulation in C++, a set of sample classes have been created that encapsulate much of the function of the framework. These classes are open source and can be found here:

[https://github.com/nkolban/esp32-snippets/tree/master/cpp\\_utils](https://github.com/nkolban/esp32-snippets/tree/master/cpp_utils)

Documentation for the classes is written in-line in the source using Doxygen.

Here we will provide additional thoughts and notes.

### GPIO interactions

GPIO functions have been encapsulated in the class called `ESP32CPP::GPIO`. Note the additional `ESP32CPP` name space. There are name space collisions without this as ESP32 itself provides a struct called GPIO.

The pin numbers are specified as the ESP-IDF native `gpio_num_t` so that we may use constants.

Each GPIO pin has a direction; either input for reading or output for writing. We must declare which direction we are using through a call to either `setInput()` or `setOutput()`. If we have set the pin as output, we can then write a value to it. We have a few choices:

- `low(pin)` – Set the output value of the pin to be low (0).
- `high(pin)` – Set the output value of the pin to be high (1).
- `write(pin, value)` – Set the output value of the pin to be the value supplied.

For reading, we call `read(pin)`.

### Example – Writing a value

```
ESP32CPP::GPIO::setOutput(GPIO_NUM_27);  
ESP32CPP::GPIO::high(GPIO_NUM_27);
```

### Example – Reading a value

```
ESP32CPP::GPIO::setInput(GPIO_NUM_27);  
bool value = ESP32CPP::GPIO::read(GPIO_NUM_27);
```

## WiFi

We have provided some C++ classes for working with WiFi. To use, we create an instance of a WiFi object. At a minimum, the following will work:

```
WiFi *pWifi = new WiFi();
pWifi->connectAP(<SSID>, <PASSWORD>);
```

If we wish, we can specify a fixed IP address, gateway and network mask:

```
WiFi *pWifi = new WiFi();
pWifi->setIPInfo("192.168.1.99", "192.168.1.1", "255.255.255.0");
pWifi->connectAP(<SSID>, <PASSWORD>);
```

Typically, we don't want to just start WiFi and forget about it but instead want to handle events. We can register an event handler using `setWifiEventHandler(handler)` where the `handler` is a class that extends `WiFiEventHandler` class. The event handler provides over-rides for:

- `virtual esp_err_t apStaConnected()`
- `virtual esp_err_t apStaDisconnected()`
- `virtual esp_err_t apStart()`
- `virtual esp_err_t apStop()`
- `virtual esp_err_t staConnected()`
- `virtual esp_err_t staDisconnected()`
- `virtual esp_err_t staGotIp(system_event_sta_got_ip_t event_sta_got_ip)`
- `virtual esp_err_t staStart()`
- `virtual esp_err_t staStop()`
- `virtual esp_err_t wifiReady()`

For example, if we wanted to create a handler to inform us when a connection to an access point is lost, we could code:

```
class MyEventHandler: public WiFiEventHandler {
    virtual esp_err_t staDisconnected() {
        // We have been disconnected ...
    }
}

mywifi.setWifiEventHandler(new MyEventHandler());
```

Before we can connect to an access point, we may want to list available access points. We can perform a scan using:

```
WiFi#scan()
```

This returns a vector of `WiFiAPRecord` objects. This object contains:



- `getAuthMode()` - Get the authentication mode
- `getRSSI()` - Get the signal strength
- `getSSID()` - Get the access point name
- `toString()` - Get a string representation of the access point

To become an access point, we might code:

```
WiFi myWiFi = WiFi();
myWiFi.startAP("myssid", "mypassword");
// You are now an access point.
```

To determine our own access point IP info, we can call `getApIpInfo()`. This returns a structure which contains our IP address, gateway address and netmask values.

### Task management

Since the ESP32 is multi-tasking through FreeRTOS, a class has been created that provides a model of such. The class is called `Task`. It is designed to be sub-classed with your own implementation. You are responsible for implementing a function called `run` which has the following signature:

```
void run(void* data)
```

For example, to create your own task, you might code:

```
#include <Task.h>
class MyTask: public Task {
    void run(void *data) {
        // do something
    }
}
```

With your class created, you can now create an instance of the task and cause it to start executing:

```
MyTask* pMyTask = new MyTask();
pMyTask->start();
```

The default stack size for the new task is 2K but you can set this to a different value before starting it. The method `setStackSize()` can be used for that purpose.

### Socket programming

We encapsulate socket programming in a class called `Socket`. To create a listening socket we call the `listen()` method that takes a port number.

If we wish to use SSL, then call `setSSL()` before the socket is created with a `listen()`. When we subsequently call `accept()` we are returned a new `Socket` instance.

## Socket Server

Creating a listening socket that can respond to incoming requests is a relatively common activity. An encapsulation of this is provided by the `SockServ` class. We create an instance of it and supply a port number.

```
SockServ mySockServ;  
mySockServ.setPort(1234);
```

When ready, we call `start()` to cause the server to start listening.

## HttpServer

Included in the C++ classes is a simple HTTP server. This can be used to serve up files from the local file system contained on your ESP32. In addition, a programmer defined callback mechanism is provided so that you can write an application which will receive notifications when a client request arrives and give you the opportunity to send a programmatic response back. This is targeted at handling inbound REST requests. The `HttpServer` also supports the WebSocket protocol to create a persistent connection between your client (browser) and the ESP32. Through the WebSocket you can send data in either direction.

Note: These classes use C++ Exception handling which means that you must enable that capability through "make menuconfig". This can be found at:

```
Compiler options -> Enable C++ exceptions
```

To use the HTTP Server, at the simplest level, you create an instance of an `HttpServer` class and ask it to start:

```
HttpServer httpServer();  
httpServer.start(80);
```

The call to `start()` takes the port number that you wish to listen upon for in-coming requests. The `start()` command is non-blocking meaning that the HTTP server will startup and then listen for incoming requests in the background.

If you wish to define callback functions that are invoked when a request arrives, you can call the `addPathHandler()` function on the `HttpServer` object instance. The syntax for this command is:

```
addPathHandler(std::string method, std::string path, handlerFunction)
```

The `method` parameter is the HTTP method your are processing. This will commonly be GET or POST. The `path` parameter is the incoming path contained in the request which will trigger the callback. Note that the callback will only be triggered when **both** the `method` and `path` match.

The callback function has the following signature:

```
void handlerFunction(HttpRequest* pRequest, HttpResponse* pResponse)
```

Here is an example of a callback function:

```
static void helloWorldHandler(HttpRequest* pRequest, HttpResponse* pResponse) {
    pResponse->setStatus(HttpResponse::HTTP_STATUS_OK, "OK");
    pResponse->addHeader(HttpRequest::HTTP_HEADER_CONTENT_TYPE, "text/plain");
    pResponse->sendData("Hello back");
    pResponse->close_cpp();
}
```

and here we define an HTTP Server to process the request:

```
HttpServer* pHttpServer = new HttpServer();
pHttpServer->addPathHandler(
    HttpRequest::HTTP_METHOD_GET,
    "/helloWorld",
    helloWorldHandler);
pHttpServer->start(80);
```

We register the handler at the path `"/helloWorld"`. As such, a browser request targeted at:

```
http://<ESP32_IP>/helloWorld
```

will trigger the processing.

The `HttpRequest` object describes the nature of the request and the `HttpResponse` object allows you to provide a response.

The methods on `HttpRequest` are:

- `std::string getBody()` – Get the body of the request message for PUT and POST.
- `std::string getHeader(std::string name)` – Get the value of a named header.
- `std::map<std::string, std::string> getHeaders()` – Get a map of all the headers and their values.
- `std::string getMethod()` – Get the method that passed in the request.
- `std::string getPath()` – Get the path of the request.
- `std::map<std::string, std::string> getQuery()` – Get the query string parts of the request.
- `Socket getSocket()` – Get the underlying TCP/IP socket.

- `std::string getVersion()` – Get the HTTP version passed in the request.
- `WebSocket* getWebSocket()` – Get the WebSocket object (assuming the request was the creation of a WebSocket).
- `bool isWebsocket()` – Return true if the request caused the creation of a new web socket.
- `std::map<std::string, std::string> parseForm()` - Parse the body data to return a map of the form name/value pairs.
- `std::vector<std::string> pathSplit()` – Split the path into its constituent parts.
- `std::string urlDecode(std::string str)` – Decode a URL string or body.

and the methods on `HttpResponse` are:

- `void addHeader(std::string name, std::string value)` – Add a header to the response.
- `void close()` – Close/complete the response.
- `std::string getHeader(std::string name)` – Get the value of a header we previously added.
- `std::map<std::string, std::string> getHeaders()` – Get all the headers that we previously added.
- `void sendData(std::string data)` – Send data to the partner.
- `void setStatus(int status, std::string message)` – Set the status value (eg. 200) for the response.

### WebSocket

Within an HTTP callback handler, you can query the incoming request and whether or not it pertains to a new WebSocket creation. To do this, you use the `HttpServer#isWebSocket()` call. If this returns true, then you have a WebSocket. When you receive a WebSocket, you will *not* be passed an `HttpResponse` object because we are now no longer processing a simple request/response transaction. Instead, we are working with a persistent connection between the `HttpServer` and the client. If you are informed that you have a WebSocket, the web socket protocol exchanges have already been performed and there is no need for you to do any other work in order to exchange data.

If you detect that your handler has been invoked because of a new `WebSocket` connection, then you can invoke the `HttpServer#getWebSocket()` function which will return you a reference to a `WebSocket` object. The `WebSocket` object has the following methods:

- `void close()` – Close the web socket.
- `Socket getSocket()` – Retrieve the underlying TCP/IP socket.
- `void send(std::string data)` – Send data to the partner.
- `void setHandler(WebSocketHandler handler)` – Set a handler for callback events.

Since an incoming `WebSocket` data transmission can occur at any time, you register a handler/callback to be informed when new data has arrived. You register this handler with the `setHandler()` function. This takes as input an instance of a class of type `WebSocketHandler` which is a class with virtual members. You can provide implementations for:

- `void onClose()` – Called when the `WebSocket` is closed.
- `void onError(std::string error)` – Called when an error with the `WebSocket` is detected.
- `void onMessage(WebSocketInputStreambuf* streambuf)` – Called when a new message is retrieved.

Default implementations are provided for the functions that you choose not to code.

The `onMessage()` callback needs a little explanation. In the C++ standard library we have the concept of streams of data. This can be the source or sink of data where we don't have to consume or generate all the data in one single unit. For our `onMessage()` callback, we might not want to receive all the data and store it into RAM. For example, if we are receiving the content of a megabyte sized file from the partner, we would be in real trouble as the ESP32 only has 512K of RAM. To solve this puzzle, we are given an object that implements the `std::streambuf` interface architected by the C++ standard library. From this object we can create a `std::istream` input stream and start pulling the data as we need. We can also use an interesting form where we can create an output stream and pass a `std::streambuf` instance to that output stream. The result is that the output stream will work with the `streambuf` to consume its presented content and transmit that to the destination of the stream. For example:

```
void onMessage(WebSocketInputStreambuf *webSocketStreambuf) {
    // Create an output stream
```

```
    ostream << websocketStreambuf;
}
```

This recipe does **not** read the data passed from the web socket into RAM before pushing it into the output stream. Instead, it will read a part and push a part and repeat until all the stream data from the web socket has been consumed.

### WebSocket File Transfer

Imagine that you wish to upload a file to your ESP32 file system. While you can use HTTP POST to push a file, there is perhaps a better solution. We have create a class that can receive incoming files through a WebSocket. When you have received a new client initiated WebSocket at your HTTP server, you can associate the WebSocket with an instance of a class called `WebSocketFileTransfer`. This will then own the web socket and process incoming files and save their results to the ESP32 file system.

For example:

```
WebSocketFileTransfer websocketFileTransfer("/spiflash");
void uploadOpenHandler(HttpRequest* pRequest, HttpResponse *pResponse) {
    if (pRequest->isWebSocket()) {
        websocketFileTransfer.start(pRequest->getWebSocket());
    }
}

HttpServer *pHttpServer = new HttpServer();
pHttpServer->addPathHandler("GET", "/upload", uploadOpenHandler);
```

When we construct a `WebSocketFileTransfer` instance, we tell it the root of the file system that files shall be written relative to.

Now let us consider the format of the incoming data. **Two** or more messages will be received over the WebSocket. The first message is a JSON string that describes the file about to be received. The second message is the data content of the file itself. This can be multiple messages containing parts of the file or one message containing the whole file.

The JSON format is:

```
{
  "name":    <fileName to be created>,
  "length": <length of the file in bytes> // This is optional.
}
```

An example of usage of this function would be to transmit a ZIP file from a PC to the ESP32. For example, we could write a Node.js application that reads a ZIP, unpacks the zip and for each file contained within, sends it over a WebSocket to the ESP32. When we run this, the result will be a copy of the content off the ZIP on the ESP32 file system.

## Performance

When a file is being served from the file system, we can't afford to load the whole file into RAM before it is transmitted. To resolve this issue, we send the file in pieces one after another. The size of a piece will affect performance. The default is 4KBytes. You can tune this by calling the `HttpServer#setFileBufferSize(size_t size)`. You should not set this higher than the amount of RAM freely available on the heap during normal operation.

## FTP Server

FTP (File Transfer Protocol) is a technology specification that allows one to request files from a remote server or store files to a remote server. On the popular operating systems such as Windows, Linux and Mac, there are both FTP Server implementations and FTP Client implementations. For the ESP32, an implementation of an FTP server component is available. When used, it allows the ESP32 to become an FTP server that will respond to remote FTP client requests to send and receive files. This assumes that an implementation of a Posix compliant file system has been made available such as found with the SPIFFs or FAT components.

To use the FTP server technology, an ESP32 should be network connected (eg. WiFi) and then create and configured an instance of the `FTPServer` C++ class.

For example:

```
FTPServer* ftpServer = new FTPServer();
ftpServer->setCallbacks(new FTPFileCallbacks());
ftpServer->start();
```

When designing the FTP server for the ESP32, it was felt that there might be opportunities for use beyond just serving files. There might be opportunities for other areas such as providing OTA images for flash. To accommodate this, a callback technique was introduced through a C++ class called `FTPCallbacks`. This class exposes a series of virtual functions that can be implemented in your own class that inherits from `FTPCallbacks`. Your class will then be called during the life cycle of FTP operations. Specifically, the following methods are exposed:

- `void onStoreStart(std::string fileName)` – Called at the start of a store request when the client wishes to store a new file.
- `size_t onStoreData(uint8_t* data, size_t size)` – Called repeatedly to provide a new chunk of data from the client to the server as part of the store request.

- `void onStoreEnd()` - Called at the end of store request to indicate that the file transfer has been completed.
- `void onRetrieveStart(std::string fileName)` – Called at the start of a retrieve request when the client wishes to retrieve a file.
- `size_t onRetrieveData(uint8_t* data, size_t size)` – Call repeatedly when the client is ready for the next chunk of data. The return from this call is the size of data to be returned. To indicate that there is no further data, return 0.
- `void onRetrieveEnd()` - Called when the data has been sent to the client.
- `std::string onDir()` - Return a listing of the current directory.

An implementation of this class called `FTPFileCallbacks` is provided which maps these commands to the Posix file-system.

An FTP Server listens on a TCP/IP port number. The default is 21. Should we wish to specify our own port number, we can call `setPort(portNumber)` prior to calling `start()`.

Since an FTP client can retrieve and store data, we may wish to include degrees of security. The most basic technique is that of a userid/password pair. By default, the ESP32 class doesn't require these but if we wish, we can enable that capability by calling `setCredentials(userid, password)` prior to calling `start()`. If configured in this manner, then the FTP client must provide a userid/password pair that match before further access will be granted. Note that FTP (by default) is inherently insecure as the data (including userid/password pairs) are transmitted in the clear without encryption. While various FTP implementations can and do provide transport channel level encryption using SSL/TLS, this has not yet been implemented in this project.

### C++ I2C Interaction

When we are going to use the I2C classes, we create an instance of the I2C class. Before we can perform work on the bus, we need to initialize the object. We do this by invoking its `init()` method which takes as input the address we wish to interact with and the pins we wish to use. The default pins are 25 for SDA and 26 for CLK.

The signature is:

```
init(address, sdaPin, sclPin, clockSpeed, portNum)
```

`sdaPin`, `sclPin`, `clockSpeed` and `portNum` have defaults.

A method called `slavePresent()` can be called to determine if a slave is present and responding at a given address.

Other functions include



- `beginTransaction()` - Create an I2C queue and add an I2C driver start command to it.
- `endTransaction()` - Add an I2C driver stop command to the queue and execute the queue.
- `getAddress()` - Get the current effective I2C slave address we are using.
- `read()` - Add a request to read data to the queue.
- `scan()` - Perform an I2C scan of all the addresses.
- `setAddress()` - Set the current effective I2C slave address we are using.
- `setDebug()` - Enable debugging.
- `slavePresent()` - Determine if a slave is present at the given address.
- `start()` - Add an I2C driver start command to the queue.
- `stop()` - Add an I2C driver stop command to the queue.
- `write()` - Add a write command to the queue.

See also:

- Working with I2C
- I2C APIs

## SPI Interaction

The C++ wrapper for SPI is found in the class called SPI. We construct an instance of this as follows:

```
SPI mySPI;
```

Next we call a function to initialize it:

```
void init(mosiPin, misoPin, clkPin, csPin);
```

This defines the pins to be used for the SPI functions. These are optional and, if not supplied, the default values will be used which are:

Function	Pin
mosiPin	13
misoPin	12
clkPin	14
csPin	15

Finally, there is a function to transfer data. Remember that for SPI, each time write a byte we simultaneously receive a byte. This means that the input buffer of data can be used to hold the resulting output buffer of data. The signature is:

```
void transfer(uint8_t* data, size_t dataLen);
```

A convenience function is made available for sending and receiving a single byte.

```
uint8_t transferByte(uint8_t value);
```

## Pulse Width Modulation - PWM

We can create an instance of a class called PWM that encapsulates all the functions we need to work with PWM.

The constructor of the class is:

```
PWM(gpioNum, frequency, bitSize, timer, channel)
```

Of these, `gpioNum` is mandatory. The others default to:

- `frequency = 100`
- `bitSize = LEDC_TIMER_10_BIT`
- `timer = LEDC_TIMER_0`
- `channel = LEDC_CHANNEL_0`

See also:

- [LEDC – Pulse Width Modulation – PWM](#)

## Bluetooth BLE

Using the low level ESP-IDF functions to build a BLE solution is considered difficult. There are a lot of concepts and there is a lot of state to be considered plus inbound events needing to be handled. This feels like an ideal candidate for a higher level class encapsulation to simplify our tasks. To that end, we have created a set of C++ classes that provide all the needed BLE capabilities with an easier model of usage.

When using these classes, we must use `make menuconfig` to configure our ESP-IDF environment. First, we need to ensure that Bluetooth is enabled. Start `make menuconfig` and navigate to Component config and select Bluetooth:

```
Terminal File Edit View Search Terminal Help
/home/kolban/esp32/esptest/apps/workspace/bt_test/sdkconfig - Espressif IoT Development Fram
e> Component config

Component config
Arrow keys navigate the menu. <Enter> selects submenu ---> (or empty submenu
----). Highlighted letters are hotkeys. Pressing <Y> includes, <N> excludes, <M>
modularizes features. Press <Esc><Esc> to exit, <?> for Help, </> for Search.
Legend: [*] built-in [ ] excluded <M> module < > module capable

  Application Level Tracing --->
  [ ] Amazon Web Services IoT Platform ----
  [*] Bluetooth --->
  C++ settings --->
  ESP32-specific --->
  [ ] WiFi ----
  PHY --->
  [ ] Ethernet ----
  FAT Filesystem support --->
  FreeRTOS --->
  Log output --->
  LWIP --->
  mbedTLS --->
  OpenSSL --->
  SPI Flash driver --->

<Select> < Exit > < Help > < Save > < Load >
```

Next drill into the Bluetooth entry and ensure "Bluedroid Bluetooth stack enabled" is selected:

```
Terminal File Edit View Search Terminal Help
/home/kolban/esp32/esptest/apps/workspace/bt_test/sdkconfig - Espressif IoT Development Fram
e> Component config > Bluetooth

Bluetooth
Arrow keys navigate the menu. <Enter> selects submenu ---> (or empty submenu
----). Highlighted letters are hotkeys. Pressing <Y> includes, <N> excludes, <M>
modularizes features. Press <Esc><Esc> to exit, <?> for Help, </> for Search.
Legend: [*] built-in [ ] excluded <M> module < > module capable

--- Bluetooth
[*] Bluedroid Bluetooth stack enabled --->

<Select> < Exit > < Help > < Save > < Load >
```

Finally, drill into the "Bluedroid Bluetooth stack enabled" and set the "Bluetooth event (callback to application) task stack size" to be 8000 (or more).

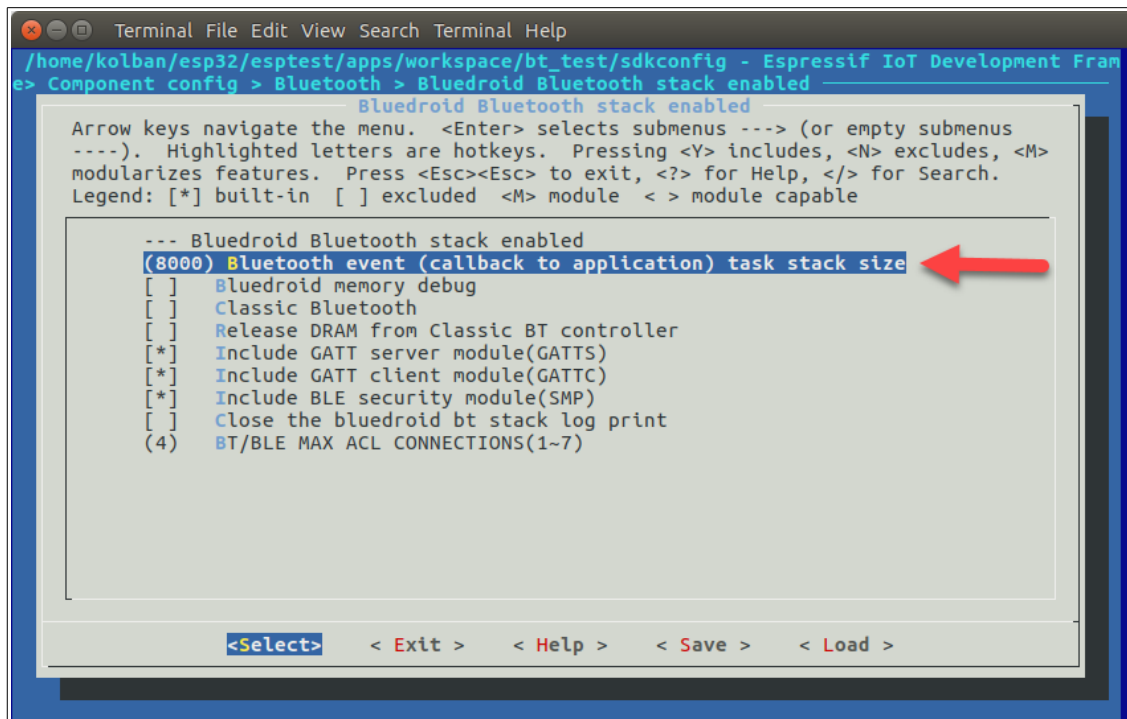

```
Terminal File Edit View Search Terminal Help
/home/kolban/esp32/esptest/apps/workspace/bt_test/sdkconfig - Espressif IoT Development Framework
e> Component config > Bluetooth > Bluedroid Bluetooth stack enabled
Bluedroid Bluetooth stack enabled
Arrow keys navigate the menu. <Enter> selects submenu ---> (or empty submenu
----). Highlighted letters are hotkeys. Pressing <Y> includes, <N> excludes, <M>
modularizes features. Press <Esc><Esc> to exit, <?> for Help, </> for Search.
Legend: [*] built-in [ ] excluded <M> module < > module capable

--- Bluedroid Bluetooth stack enabled
(8000) Bluetooth event (callback to application) task stack size
[ ] Bluedroid memory debug
[ ] Classic Bluetooth
[ ] Release DRAM from Classic BT controller
[*] Include GATT server module(GATTS)
[*] Include GATT client module(GATTC)
[*] Include BLE security module(SMP)
[ ] Close the bluedroid bt stack log print
(4) BT/BLE MAX ACL CONNECTIONS(1-7)

<Select> < Exit > < Help > < Save > < Load >
```

Save all your changes are rebuilt the source.

We'll split our story into two parts ... one being a BLE Server and the other being a BLE Client.

### A BLE Server

A BLE Server is also known as a BLE Peripheral. It is likely that this is how you will most commonly use the ESP32. With a BLE Server, you will expose one or more services where each service has one or more characteristics and each characteristic may have zero or more descriptors. I think we'll agree that is quite a lot going on.

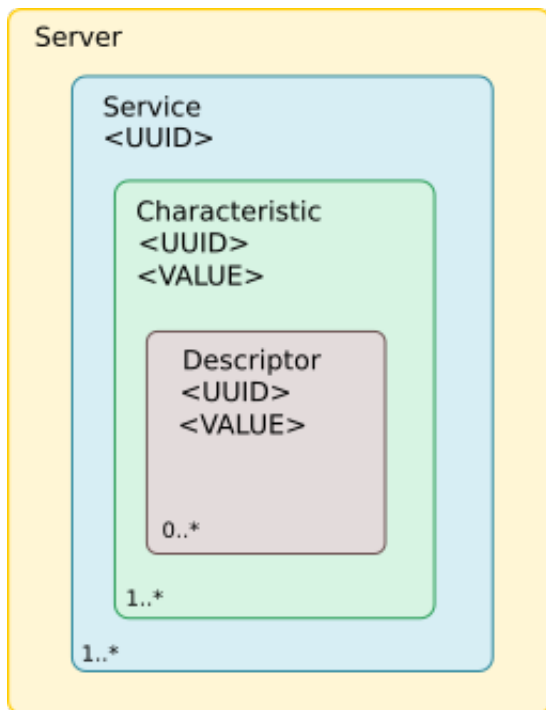

In our C++ model, we create the concept of classes that represent these items.

- `BLEServer` – Models a server.
- `BLEService` – Models a service. Owned by a `BLEServer`.
- `BLECharacteristic` – Models a characteristic. Owned by a `BLEService`.
- `BLEDescriptor` – Models a descriptor. Owned by a `BLECharacteristic`.

And also:

- `BLEAdvertising` – Models advertising. Owned by a `BLEServer` to let others know of our existence.

At a high level, the pseudo code of a minimal BLE server becomes:

```
// Initialize the BLE environment
BLEDevice::init("ServerName");

// Create the server
BLEServer* pServer = BLEDevice::createServer();

// Create the service
BLEService* pService = pServer->createService(ServiceUUID);
```

```

// Create the characteristic
BLECharacteristic* pCharacteristic =
    pService->createCharacteristic(CharacteristicUUID, properties);

// Set the characteristic value
pCharacteristic->setValue("Hello world");

// Start the service
pService->start();

```

Hopefully you see how this fits together ... we create the server, we create the service, create a characteristic upon the service, set a value for the characteristic and then ask the service to start responding to incoming requests.

If you are familiar with the ESP32 BLE APIs supplied by ESP-IDF, you may notice what is missing ... all the complexity and glue code necessary for event handling and processing of BLE requests. All of this is *handled for you* by the implementation of the classes. This means that you can focus on your intent/usage of BLE while keeping your *plumbing* to a minimum.

The goal of these classes is to efficiently process BLE workflow while encapsulating the plumbing so you don't need to worry about it ... but within is the danger that the implementation will restrict you from some tasks by hiding functions that you might otherwise have needed for your own project. Thankfully, this has not been seen to be the case. The classes expose simple high level APIs for the 95% of common practices while at the same time providing methods that can be called to tweak and tailor the operations for the rarer cases. Hopefully you won't need those often but, if and when you do, they are there for you.

When a BLE Server is running, what must happen next is that peer devices (clients) must be able to locate it. This is made possible through the notion of advertising. The BLE Server can broadcast its existence along with sufficient information to allow a client to know what services it can provide.

Once we have started the BLE Server, we can ask it for an object (`BLEAdvertising`) that owns the advertisements that the server produces:

```

BLEAdvertising* pAdvertising = pServer->getAdvertising();
pAdvertising->start();

```

Once performed, the server can be dynamically found by the clients. Of course a server doesn't *need* to advertise. If a client should otherwise be informed (or remember) the address of the BLE server, it can request a connection at any time.

As part of the advertisement offered by the BLE device we have the option of telling potential interested parties about the services our device offers. We can advertise one or more services by calling the `addServiceUUID()` method prior to starting to advertise.

The ESP-IDF provides a built-in structure for common advertisements but there are many more advertisement types than those chosen by Espressif. To support this, we can construct our own advertisement payload and associate that with what the ESP32 advertises. This is achieved through the `BLEAdvertisementData` class type. We create an instance of this class, populate it with the advertisement payload we wish to distribute and then start advertising.

At a high level:

```
BLEAdvertising* pAdvertising = pServer->getAdvertising();
BLEAdvertisementData advertisementData;
// set the properties of the advertisement data
// See the setter methods of the BLEAdvertisementData class
pAdvertising->setAdvertisementData(advertisementData);
pAdvertising->start();
```

A core concept of BLE is the notion of the characteristic. Think of this as a stateful *record* that has an identity and a value. A peer device (if permitted) can read the value of the characteristic or set a new value. Remember, it is the BLE characteristic that owns the existence of the value so that it may be served up or changed upon request. This is the core notion of BLE. The value read from the characteristic provides information. For example, if the characteristic represents your heart-rate measured from a sensor, then a remote client can retrieve your current heart rate by reading the current characteristic value. In this case, a remote client will not be setting the value, instead the value will be changed internally by the server either each time a read request by a client is made or when a new sensor reading is taken. Alternatively, the characteristic maintained in the BLE Server may represent the state of something that can be activated or changed. As another example, imagine that the characteristic represents the state of your car door's lock. You can read the characteristic to determine that your door is locked when you leave or, conversely, you can set the characteristic's value to an unlocked state which would result in the server mechanically unlocking the door.

To model these notions in our C++ classes, we leverage the notion that a C++ class can be sub-classed to be more specialized. A class called `BLECharacteristicCallbacks` provides two methods that can be over-riden:

- `onRead(BLECharacteristic* pCharacteristic)` – Called when a read request arrives from a client. A new value for the characteristic can be set before return from the function and will be used as the value received by the client.
- `onWrite(BLECharacteristic* pCharacteristic)` – Called when a client initiated write request arrives. The new value has been set in the characteristic already and your own code logic can read the value and perform some action.

To utilize, we can then override these functions in our own C++ class that sub-classes the one provided:

```
class MyCallback: public BLECharacteristicCallback {
    void onRead(BLECharacteristic* pCharacteristic) {
        // Do something before the read completes.
    }

    void onWrite(BLECharacteristic* pCharacteristic) {
        // Do something because a new value was written.
    }
}
```

To use this technique, we inform our `BLECharacteristic` about a callback handler. For example:

```
pCharacteristic->setCallbacks(new MyCallback());
```

Here is an example that sends the time since startup each time a client requests the value:

```
class MyCallbackHandler: public BLECharacteristicCallbacks {
    void onRead(BLECharacteristic* pCharacteristic) {
        struct timeval tv;
        gettimeofday(&tv, nullptr);
        std::ostringstream os;
        os << "Time: " << tv.tv_sec;
        pCharacteristic->setValue(os.str());
    }
};
```

Similar to the characteristic callbacks, we also have server callbacks. These inform your code about client connection and disconnection events. These are sub-classed from the `BLEServerCallbacks` class which has virtual methods for:

- `onConnect(BLEServer* pServer)` – Called when a connection occurs.
- `onDisconnect(BLEServer* pServer)` – Called when a disconnection occurs.

These could be used to enable or disable sensor readings. For example, if we have no clients connected then there is no need to spend energy sampling a value if there is no one there to read it. However, when a client connects, we can detect that and start reading from the sensor at that point until a subsequent disconnection indication is detected.



Another consideration for our BLE Server is the idea that we might want to "push" data to the peer when something interesting happens. Up until now we have considered the idea that the server can receive read requests to get the current value or can receive write requests to set the current value. There is one more operation that we are interested in that is invoked on the server side by the server and asynchronously to the client. That operation is called "notify". It is used to signal (or notify) to the client that the characteristic's value has changed. The client will receive an indication event to let it know that the change has occurred.

On the server, we can cause an indication to occur by invoking:

```
pCharacteristic->notify();
```

The current value of the characteristic will be the value transmitted to the peer. We might pair this call with a previous request to set a new value:

```
pCharacteristic->setValue("HighTemp");  
pCharacteristic->notify();
```

A similar function to `notify()` is called `indicate()`. The distinction between them is that an `indicate()` receives a confirmation while a `notify()` does not receive a confirmation.

Associated with the idea of indications/notifications, is the architected BLE Descriptor called "[Client Characteristic Configuration](#)" which has UUID 0x2902. This contains (among other things) two distinct bit fields that can be on or off. One bit field governs Notifications while the other governs Indications. If the corresponding bit is on, then the server can/may send the corresponding push. For example if the Notifications bit is on, then the server can/may send notifications. The primary purpose of the descriptor is to allow a partner (a client) to request that the server *actually* send notifications or indications. Here is an example.

Imagine that we have a BLE Server that can publish notifications when data changes. Now imagine that a BLE Client connects but is actually not interested in receiving these. If the BLE Server executes a notification push and sends the data, that will be wasted effort/energy as the client doesn't want or can't use the information. What we really want is that the client should inform the server that *if* it wants to push new data then it either should or shouldn't. And that is where this descriptor comes into play. If the descriptor is present on a characteristic then then client can remotely change the bit flag to enable or disable notifications and indications. Since the descriptor flag is stored locally within the server, the server is at liberty to examine the flag before performing a radio transmission. What this means is that the client/peer can toggle on or off its desire to receive notifications and the server should honor those requests.

The BLE specification constrains the maximum amount of data that can be sent through a notification or indication to be 20 bytes or less. Take this into account in your designs. If the value of a characteristic is greater than this amount, then only the first 20 bytes of the data will be transmitted.

It is likely that your own BLE server application is going to expose its own set of characteristics. Through a characteristic you can set and get the value as a binary piece of storage, however this may be too low level for you. An alternative is to utilize the features of the C++ language and model your own specialized characteristic as a sub class of `BLECharacteristic`. This could then encapsulate the lower level value's getter and setter with your own customized version.

For example, if your characteristic represented a temperature, you could create:

```
class MyTemperatureCharacteristic: public BLECharacteristic {
    MyTemperature(): BleCharacteristic(BLEUUID(MYUUID)) {
        setTemperature(0.0);
    }

    void setTemperature(double temp) {
        setValue(&temp, sizeof temp);
    }

    double getTemperature() {
        return *(double*)getValue();
    }
}
```

### A BLE Client

Now we will turn our attention to the second half of our story, namely that of being a client. In this story, our ESP32 doesn't host services but instead wishes to be a consumer of services hosted elsewhere. The story can further be broken down into two sub-stories ... namely scanning and interaction.

If we assume that our ESP32 starts up and wishes to be a client of a remote BLE server then it has to connect to that server. In order to connect to the server, we need to know the address of the target server. An address is a 6 byte value commonly written in the form

```
nn:nn:nn:nn:nn:nn
```

While in principle this can be hard-coded into your application or manually entered through some other interaction story, this is not the common practice. Instead, we perform a procedure known as a *scan*. Scanning is the idea that we actively listen on the BLE radio frequencies for servers which are advertising their existence. As an analogy, imagine we enter a dark room and we have no idea who is in there with us. We take off our ear-muffs (yes, for some reason we entered a dark room with no light at

all wearing ear-muffs ... but then, this is just an analogy) and we start hearing voices. We hear "Hi this is Bob, I can make toast" and "Hi this is Susan, I can tell you what temperature it is" and we also hear "Hi this is Brian, ask me what I can do". In this analogy, Bob, Susan and Brian are the addresses of the BLE devices. Each of them are continually saying out loud that they exist and, in some cases, what they can do for us.

When we perform a BLE scan, we receive small sized records of data that *always* contain the address of the advertiser and *sometimes* additional information such as the services they provide or other descriptive items. This information arrives at us passively. All we need do is listen and we learn. Should we need to learn more about the devices, we can connect to them (even the ones that told us little) and explicitly ask them for more details of what they can do.

That is the principle of scanning. In our C++ BLE story, we have modeled this through the C++ class called `BLEScan`. We get an instance of this class by asking the BLE device for it using:

```
BLEScan* pMyScan = BLEDevice::getScan();
```

The object returned to us is a singleton. This was chosen because we will only want to be scanning once per ESP32 at any given time.

The `BLEScan` object, when presented to us, isn't actually yet scanning, to start it scanning we invoke its `start()` method passing in the duration of how long we would like it to scan for. This is an interval measured in seconds. For example:

```
pMyScan.start(30); // Scan for 30 seconds
```

This is a blocking call. It will return after the scan period has elapsed. It returns an object instance of type `BLEScanResults` that contains the information for each unique device found. If we have an instance of `BLEScanResults` we can ask it how many results it contains (via a call to `getCount()`) and we can then retrieve each advertised device (via a call to `getDevice(index)`).

Since we are scanning, we will want to know as soon as possible about the devices that we find and this is where a callback function comes into play. Before calling `start()` we can register a callback function that will be invoked for each peer device that was found. An abstract C++ class called `BLEAdvertisedDeviceCallbacks` works for us here. This has a method on it called `onResult()` which will be invoked for each unique result found during scanning. Note that we don't pass the same detected device twice; if it wasn't

the one you were previously looking for, it still won't be the one you want a short while later. This method is passed in to your callback function as an instance to an object of type `BLEAdvertisedDevice` that describes the nature of the device that we found.

For example:

```
class MyCallbacks: public BLEAdvertisedDeviceCallbacks {
    void onResult(BLEAdvertisedDevice advertisedDevice) {
        // Do something with the found device ...
    }
}

BLEDevice::init("");
BLESan* pMyScan = BLEDevice::getScan();
pMyScan->setAdvertisedDeviceCallbacks(new MyCallbacks());
pMyScan->start();
```

What this means is that for every unique device that the scan finds, a call to `onResult()` will be made which is passed an instance of a `BLEAdvertisedDevice` which describes that device. Now let us look at what a device *may* tell us. The only thing that a device will tell us for sure is its BLE address. Beyond that, everything else is optional. The *possible* attributes that an advertised device may inform us about is large and the following subset have been modeled (so far):

- Appearance
- Manufacturer data
- Name
- RSSI
- Primary service UUID
- Transmit power

Since none of these are mandatory in an advertisement, for any given advertised device we learn about, we can't immediately ask about the value of the property. Instead, we have methods that tell us which properties are present and, if present, **then** we can ask for its value.

For example, in our processing logic we may code:

```
if (advertisedDevice.hasServiceUUID()) {
    BLEUUID service = advertisedDevice.getServiceUUID();
    if (service.equals(BLEUUID((uint16_t)0x1802)) {
        // we found a useful device ...
    }
}
```

(The above is merely an example of the logic that can be employed).

If we wish to end the scan early; presumably because we found the device we wanted, we can call the `stop()` method of the `BLEScan` object. A reference to the `BLEScan` is conveniently available within the `BLEAdvertisedDevice` object.

```
advertisedDevice.getScan()->stop();
```

From all of this ... we end up with the identification of a device that was of interest to us and since we want to be a BLE Client, this will presumably mean the device to which we wish to connect. The key item in the advertisement now becomes the device's address which we can obtain through a call to `getAddress()`.

Now we can turn our attention to actually connecting to the server.

A BLE Client is modeled as the `BLEClient` class. We obtain an unconnected instance of this by asking the ESP32 for one:

```
BLEClient* pMyClient = BLEDevice::createClient();
```

Next we request a connection to the target device.

```
pMyClient->connect(address);
```

... and that's it. The `connect()` is a blocking call and, on return, we are connected. However, that isn't the end of the story. Just connecting to a peer is usually not enough. Now we want to read and write the values that the remote BLE server is hosting. If we think back to our understanding of the story, the remote server has one or more services and each service has one or more characteristics and it is these characteristics that hold the values. This means that it doesn't make sense to say "I want to read the value of the remote BLE server" ... instead we must say "I want to read the value of a named remote characteristic". However, even that is not enough. There may be multiple services on the BLE server each of which have their own characteristic which may be of the same characteristic type and hence not be uniquely identified. Thus we end up with the final concept of "I want to read the value of a named remote characteristic that is owned by a named service". From this notion, we now get to introduce two more models. Those are the `BLERemoteService` and `BLERemoteCharacteristic`.

Once we have connected to a BLE Server, we can request a reference to the `BLERemoteService` that models a service on that server:

```
BLERemoteService* pMyRemoteService = pClient->getService(serviceUUID);
```

and once we have a reference to the service, we can ask *that* service for a reference to the desired characteristic.

```
BLERemoteCharacteristic* pMyRemoteCharacteristic =
    pMyRemoteService->getCharacteristic(characteristicUUID);
```

and finally ... we can work with the values associated with the characteristic:

```
std::string myValue = pMyRemoteCharacteristic->readValue();
```

to read the value and ...

```
pMyRemoteCharacteristic->writeValue("abc");
```

to write a new value. If all that seems like a lot of work ... lets put it together in context and see:

```
// Create the client
BLEClient* pMyClient = BLEDevice::createClient();

// Connect the client to the server
pMyClient->connect(address);

// Get a reference to a specific remote service on the server
BLERemoteService* pMyRemoteService = pClient->getService(serviceUUID);

// Get a reference to a specific remote characteristic owned by the service
BLERemoteCharacteristic* pMyRemoteCharacteristic =
    pMyRemoteService->getCharacteristic(characteristicUUID);

// Retrieve the current value of the remote characteristic.
std::string myValue = pMyRemoteCharacteristic->readValue();
```

... and that's it. Hopefully you see that is pretty elegant (and if not, *please* contact me and we'll see if we can't improve on it ... but come bearing suggestions for what can be improved).

To close, we will look at a BLE Client receiving notifications from the server. Since a server can notify a client at any time, we need a callback mechanism to asynchronously process those events. The `BLERemoteCharacteristic` object exposes a method called `registerForNotify(callbackHandler)`. When invoked, we register a callback handler function with the following signature:

```
void notifyCallback(
    BLERemoteCharacteristic* pBLERemoteCharacteristic,
    uint8_t* data,
    size_t length,
    bool isNotify)
```

This function is invoked when the BLE Server transmits a notification message. The function is called with a reference to the characteristic associated with the notification along with the data and the length of the data transmitted by the server.

Should we wish to un-register for notifications, we can call `registerForNotify()` again but this time pass `NULL` as the callback function.

## Non Volatile Storage

We have a C++ class called NVS that provides non-volatile storage access. We create an instance of the class to access a specific name-space:

```
NVS myNamespace ("namespace1");
```

From there we have getter/setters for the data types. Supported types include:

- string
- blob (see string)
- uint32\_t

We can erase all values in the namespace with `erase()` and erase a specific key with `erase("<keyname>")`. If we change data with a setter, we must execute `commit()` to commit the changes.

## FAT FS

The FAT FS file system provides the ability to read and write files to flash memory. A class called `FATFS_VFS` provides a mapping to this from C++. To use, we create an instance and specify the mount point in the file system and the partition name used to hold the storage.

```
#include <FATFS_VFS.h>

FATFS_VFS *fs = new FATFS_VFS("/spiflash", "storage");
fs->mount();
```

## Working with JSON

A class is provided for working with JSON string data.

At the simplest level we can parse a string containing JSON data using:

```
JsonObject obj = JSON::parseObject(<object as a string>);
```

If an error is detected while parsing a JSON string, the resulting `JsonObject`'s `isValid()` method will return false.

From the returned `JsonObject` instance, we can then call methods to retrieve the properties including:

- `getInt()` - Returns an int.

- `getString()` - Returns a `std::string`.
- `getObject` – Returns a `JsonObject`.

When we are given a `JsonObject`,

See also:

- [Github: DaveGamble/cJSON](#)
- JSON processing

## POSIX file system APIs

The POSIX specification provides some APIs for working with a file system that are available to us and mapped to the ESP-IDF Virtual File System. These include:

- [close](#)
- [fstat](#)
- [link](#)
- [lseek](#)
- [open](#)
- [read](#)
- [rename](#)
- [stat](#)
- [unlink](#)
- [write](#)

In addition, there are a set of directory manipulation functions. These functions are defined in the header file called:

```
#include <dirent.h>
```

The high level notion of using directory access is that we open a directory by its path and are returned an object that represents that directory. This object is an instance of a `DIR` object. Within the `DIR` object is maintained the state of what entries are contained within the directory as well as a *current pointer* to the next entry to be retrieved.

A call to `readdir()` returns the next directory entry. This is an instance `struct dirent` which will contain the following fields:

- `d_ino` – The identity of the directory entry.



- `d_name` – The name of the directory entry.
- `d_type` – The type of the file:
  - `DT_UNKNOWN` – Unknown type of file.
  - `DT_REG` – Regular file.
  - `DT_DIR` – Directory.

The directory functions available to us are:

- [`closedir`](#) – Close a directory previously opened by `opendir()`.
- [`mkdir`](#) – Create a new directory.
- [`opendir`](#) – Open a directory for access, returns a pointer to a `DIR`.
- [`readdir`](#) – Read a directory entry from a `DIR`.
- [`rmdir`](#) – Remove a directory.
- [`seekdir`](#) – Change the position of the next directory entry to be retrieved.
- [`telldir`](#) – Retrieve the current location of the next directory entry to be retrieved.

Note that the SPIFFS file system does **not** support this style of directory access while the FATFS file system does.

## Documenting your code - Doxygen

For C and C++ source applications, the defacto standard for documentation is the Doxygen tool. Doxygen is big and rich and here we will capture a cheat sheet to get you going with working with your source.

Doxygen is an application that has dependencies on another tool called "Graphviz".

A GUI tool called "doxywizard" is available after installing "doxygen-gui"

See also:

- [Doxygen](#)
- [Graphviz](#)

### Creating a build environment on the Raspberry Pi 3

Many programmers believe that Linux is a superior development environment than other operating systems such as Windows or Mac OSX. Words like "superior" and "better" are usually subjective and I will avoid any discussion along those lines. Should one choose to use Linux as a development environment, there are many choices for where one hosts it. In this section, we are going to examine using the 4 core Raspberry Pi model 3 as a platform for hosting Linux and building an ESP32 development environment.

The CPU on the Raspberry Pi is ARM based which means that we need a cross compiler to build executables for an ESP32. At the time of writing, there is not a known location for a binary download of the tool suite for ESP32 so our choice is to build it from scratch. Fortunately there are instructions for this in the "linux-setup.rst" document found as part of the ESP-IDF project. In summary the steps are:

```
$ sudo apt-get install gawk gperf grep gettext libcurses5-dev python python-dev
automake bison flex texinfo help2man libtool libtool-bin
$ git clone -b xtensa-1.22.x https://github.com/espressif/crosstool-NG.git
$ cd crosstool-NG
$ ./bootstrap && ./configure --prefix=$PWD && make install
$ ./ct-ng xtensa-esp32-elf
$ ./ct-ng build
$ chmod -R u+w builds/xtensa-esp32-elf
```

Be aware that the build of the tool chain requires about 4GBytes of storage in order to complete. As such, you will likely need a much larger micro SD card than the minimum of 8GBytes that is normally used with a Pi. The resulting binaries for the tool chain end up at about 100MBytes. You might want to download the files pre-compiled. A version of the files can be downloaded from my web site from:

<http://www.neilkolban.com/esp32/downloads/xtensa-esp32-elf.tar.gz>

Once downloaded, I suggest extracting the content into /opt using:

```
$ sudo tar --extract --directory /opt --ungzip --file xtensa-esp32-elf.tar.gz
```

To physically construct a PI/ESP32 environment, I recommend the following. First, get two full sized breadboards and remove the power rail from one of them. Next, bind the two together at the edge where you removed a power rail such that there is only one power rail between the two boards. This will then allow an ESP32 DevKitC to bridge between them. Now on one of the breadboards, we can plug in a Raspberry PI extender. We now have both the PI and the ESP32 col-located on the boards.

Taking a short USB cable, plug the DevKitC into the PI. This will provide both power to the DevKitC as well as give us a serial port. On the PI, if we now run "lsusb", we will see the DevKitC:

```
$ lsusb
Bus 001 Device 018: ID 10c4:ea60 Cygnal Integrated Products, Inc. CP210x UART Bridge /
myAVR mySmartUSB light
Bus 001 Device 003: ID 0424:ec00 Standard Microsystems Corp. SMSC9512/9514 Fast
Ethernet Adapter
Bus 001 Device 002: ID 0424:9514 Standard Microsystems Corp.
Bus 001 Device 001: ID 1d6b:0002 Linux Foundation 2.0 root hub
```

The DevKitC is the first entry. To further validate, we can look for /dev/ttyUSB0:

```
$ ls -l /dev/ttyUSB0
crw-rw---- 1 root dialout 188, 0 Sep 25 10:27 /dev/ttyUSB0
```

This is the serial port that shows up with a USB→Serial connector such as DevKitC.

We can now connect a serial terminal to this serial port and see the information produced from it. One can use a tool such as "screen" to achieve this task. This tool is not installed by default on the PI so we need to install it with:

```
$ sudo apt-get install screen
```

Once installed, we can run:

```
$ screen /dev/ttyUSB0 115200
```

At this point we should be seeing the serial output from the ESP32. To end our "screen" session, we use the cryptic:

```
CTRL+A
```

followed by

```
:quit
```

Now let us turn our attention to using the PI to control booting and other useful functions. We want to map some PI GPIO pins to some of the ESP32 functions. The choice of PI pins is arbitrary but in my solution, I used the following:

PI Pin	ESP32 function
17	EN
27	IO0 (Used for boot mode selection)
GND	GND (common ground)

This is illustrated in the following schematic:

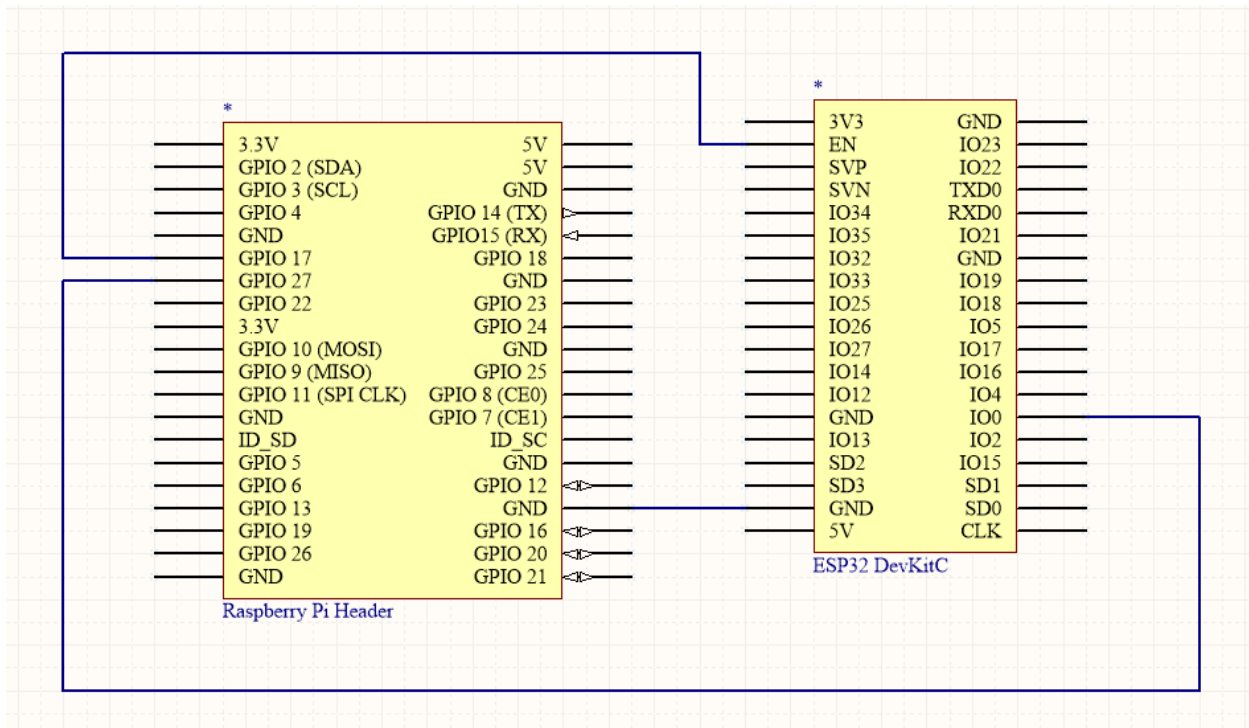

Now we can look to some software to achieve our goals.

See also:

- [Github: esp-idf/.../linux-setup.rst](#)
- [YouTube: ESP32 – Development environment on PI](#)

## Using Microsoft Visual Studio Code for development

There are many free editors and development environments downloadable from the web. A relatively new player is Microsoft's Visual Studio Code. Microsoft has always been number one in development environments for Windows based application development and their Visual Studio Code (VSC) is a quick starting, high function editor available for both Windows **and** Linux. Here we will examine what it takes to use it together with the ESP-IDF to build ESP32 based applications.

The high level recipe is:

1. Download and install Visual Studio Code
2. Install some of the extensions / plugins. Specifically:
  1. C/C++
  2. Native debug
3. Configure the `.vscode` project settings including:
  1. `c_cpp_properties.json`

Now let us consider the actions we wish to perform.

- File editing
- Building
- Make menuconfig
- Flashing

With the environment in place, we can now consider some of the benefits of using VSC. First, it is nicely integrated into your loose environment. It is not opinionated about how its workflow should be performed but instead is highly configurable providing you the opportunity to customize it as you see fit.

If we define make as the default build command, it can perform a normal/standard ESP-IDF build of the environment with ease. The output of the gcc based toolchain is automatically parsed and any error messages can be tied to the editor such that a click on a failure line will take you right to the offending location.

See also:

- [Visual Studio Code](#)
- [Github: Virgilia/esp32-devenv-vscode](#)
- [Github: Deous/VSC-Guide-for-esp32](#)

## Debugging with Visual Studio Code

Visual Studio Code can also be an excellent framework for source code debugging. To achieve this, we first need to get our solution to the state where we can use the `gdb` debugger from the command line. This will involve installing and configuring `openocd` for the ESP32. Once configured, we should also start the `openocd` server demon.

Next, we can open our Visual Studio Code and switch to the Debug set of views:

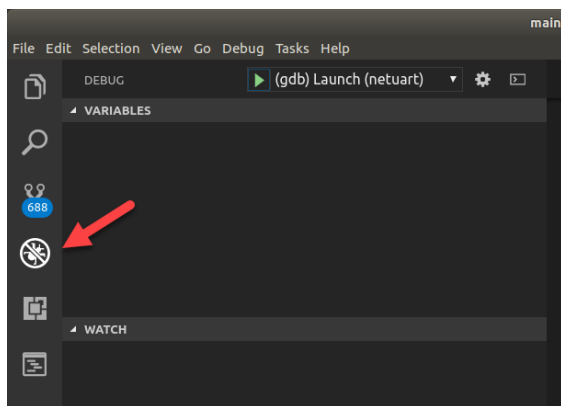

From there we can edit the debugging configuration:

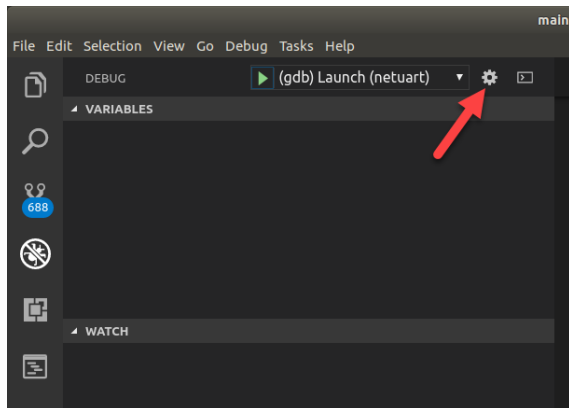

The result will place us in a JSON editor in the file called `launch.json`:

```
{
  "version": "0.2.0",
  "configurations": [
    {
      "name": "ESP32 OpenOCD launch",
      "type": "cppdbg",
      "request": "launch",
      "program": "./build/app-template.elf",
      "args": [],
      "stopAtEntry": true,
      "cwd": "${workspaceFolder}",
      "environment": [],
      "externalConsole": false,
      "MIMode": "gdb",
      "miDebuggerPath": "/opt/xtensa-esp32-elf/bin/xtensa-esp32-elf-gdb",
      "setupCommands": [
        {
          "description": "Enable pretty-printing for gdb",
          "text": "-enable-pretty-printing",
          "ignoreFailures": true
        },
        {
          "text": "target remote localhost:3333"
        },
        {
          "text": "monitor reset halt"
        },
        {
          "text": "flushregs"
        },
        {
          "text": "thb app_main"
        }
      ],
      "logging": {
        "trace": true,

```

```

        "traceResponse": true,
        "engineLogging": true
    }
}
]
}

```

You may have to modify the content to match your environment. Finally, you may have to modify the file found at:

```
openocd/share/openocd/scripts/target/esp32.cfg
```

and modify the line to:

```
set ESP32_RTOS none
```

Now we should start `openocd` and we can run our debugger inside Visual Studio Code. If we set breakpoints, those will be honored.

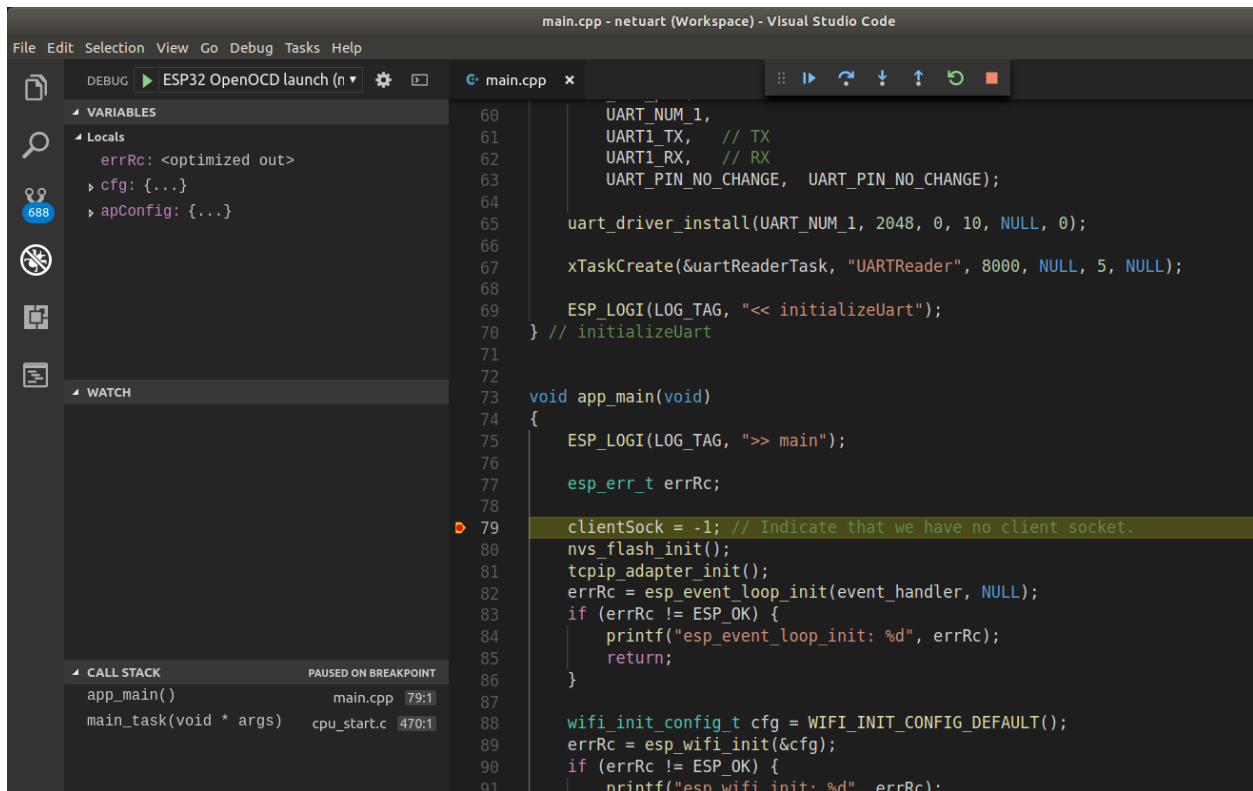

Breakpoints can be added in the column just to the left of the line number.

See also:

- [OpenOCD and JTAG](#)
- [Using a debugger \(GDB\)](#)
- [Using Microsoft Visual Studio Code for development](#)
- [GoJimmyPi – VSCode JTAG Debugging of ESP32 – Part 2](#)

## Windows Subsystem for Linux - WSL

On Windows 10 we can install a Linux subsystem. What this means in simple terms is that we can install a Linux distribution on our Windows machine and, from a Windows environment, freely execute Windows commands including compilation and other important ESP32 related tasks.

1. Open the PowerShell tool as a Windows administrator and run

```
Enable-WindowsOptionalFeature -Online -FeatureName Microsoft-Windows-Subsystem-Linux.
```

You will be asked if you wish to reboot for this to take effect.

2. Now we choose a distribution of Linux that we wish to install. We have three choices. Ubuntu, OpenSUSE and SLES. In my example, I chose Ubuntu which was about 200MB to download.
3. Turn on Windows developer mode

```
Settings -> Update and Security -> For developers
```

4. Run `bash` at a DOS command prompt.

At this point you are now in a Linux shell and can perform all the commands you would normally think of doing in an ordinary Linux environment. Since we are working with the ESP32, access to the serial port is also extremely important. The serial ports are mapped to:

```
/dev/ttyS<number>
```

where the number is the Windows `COM<number>` for the corresponding serial port. If you are unsure which serial port on windows is being used, we can open a DOS window and run `"mode"`. This will provide a listing for all the devices. Look for the ones that begin with `"COMnn"`. These are the serial ports. Connect/disconnect your ESP32 and look for the COM port values changing.

My experience shows that we don't immediately have access to the port because of Linux permissions. However running:

```
$ sudo chmod 666 /dev/ttyS<number>
```

cures that right up.

When you flash your ESP32, you can over-ride the path used for the target by setting the `ESPPORT` variable. For example:

```
$ export ESPPORT=/dev/ttyS6
```

The Windows file system can be found at `/mnt/<drive>`.

Since the WSL doesn't provide a graphical environment, you will typically be accessing it by running `bash` from a DOS prompt



You will also want to change your environment. We can do this by editing `~/.bashrc` and adding:

```
PATH=/opt/xtensa-esp32-elf/bin:$PATH
export IDF_PATH=<Path to the esp-idf>
```

I also recommend setting the TERM environment variable to `"xterm"` as opposed to `"xterm-256color"`. In my opinion, the coloring can be difficult to read in a DOS window.

Parallel makes do not appear to work. So don't try `"make -j5"` or equivalent.

See also:

- [Windows Subsystem for Linux Documentation](#)

## Makefiles

Books have been written on the language and use of Makefiles and our goal is not to attempt to rewrite those books. Rather, here is a cheaters guide to beginning to understand how to read them.

A general rule in a make file has the form:

```
target: prereqs ...
    receipe ...
```

Variables are defined in the form:

```
name=value
```

We can use the value of a variable with either `$(name)` or `${name}`.

Another form of definition is:

```
name:=value
```

Here, the value is locked to its value at the time of definition and will not be recursively expanded.

We can concatenate a value to a variable using:

```
name+=value
```

Some variables have well defined meanings:

Variable	Meaning
CC	C compiler command
CXX	C++ compiler
CFLAGS	Flags for the C compiler
CPPFLAGS	Flags for the C++ compiler
AR	Archiver command
LD	Linker command
OBJCOPY	Object copy command
OBJDUMP	Object dump command

We can use the value of a previously defined variable in other variable definitions. For example:

```
XTENSA_TOOLS_ROOT ?= c:/Espressif/xtensa-lx106-elf/bin
CC := $(XTENSA_TOOLS_ROOT)/xtensa-lx106-elf-gcc
```

defines the C compiler as an absolute path based on the value of a previous variable.

Special expansions are:

- `$$` - The name of the target
- `$(` - The first prereq

Comments are lines that start with an "#" character.

Wild cards are:

- `*` - All characters
- `?` - One character
- `[...]` - A set of characters

Make can be invoked recursively using

```
make -C <directoryName>
```

Imagine we wanted to build a list of source files by naming directories and the list of source files then becomes all the ".c" files, in those directories? How can we achieve that?

```
SRC_DIR = dir1 dir2
SRC := $(foreach sdir, $(SRC_DIR), $(wildcard $(sdir)/*.c))
OBJ := $(patsubst %.c, $(BUILD_BASE)/%.o, $(SRC))
```

The puzzle

Imagine a directory structure with

```
a
  a1.c
```

```
    a2.c
b
    b1.c
    b2.c
```

goal is to compile these to

```
build
  a
    a1.o
    a2.o
  b
    b1.o
    b2.o
```

We know how to compile `x.c` → `x.o`

```
MODULES=a b
BUILD_BASE=build
BUILD_DIRS=$(addprefix $(BUILD_BASE)/,$(MODULES))
SRC=$(foreach dir, $(MODULES), $(wildcard $(dir)/*.c))
# Replace all x.c with x.o
OBJS=$(patsubst %.c,%o,$(SRC))

all:
    echo $(OBJS)
    echo $(wildcard $(OBJS)/*.c)
    echo $(foreach dir, $(OBJS), $(wildcard $(dir)/*.c))
    echo "SRC: " $(SRC)

test: checkdirs $(OBJS)
    echo "Compiled " $(SRC)

.c.o:
    echo "Compiling $(basename $<)"
    $(CC) -c $< -o build/$(addsuffix .o, $(basename $<))

checkdirs: $(BUILD_DIRS)

$(BUILD_DIRS):
    mkdir -p $@

clean:
    rm -f $(BUILD_DIRS)
```

Makefiles also have interesting commands:

- `$(shell <shell command>)` – Run a shell command.
- `$(info "text"), $(error "text"), $(warning "text")` – Generate output from make.

See also:

- [GNU make](#)
- [Makefile cheat sheet](#)

## The component.mk settings

Within the ESP-IDF environment, we have the `component.mk` build system. This uses specific variables for its configuration.

For a component specific `component.mk` we have:

- `COMPONENT_ADD_INCLUDEDIRS` – Directory to be added to the include path of the entire project.
- `COMPONENT_PRIV_INCLUDEDIRS` – Relative path to include directories that will only be used for module compilation.
- `COMPONENT_DEPENDS` –
- `COMPONENT_ADD_LDFLAGS` – Additional flags used at link time.
- `COMPONENT_EXTRA_INCLUDES` –
- `COMPONENT_SRCDIRS` – A set of one or more directories relative to the location of the component which are expected to contain source files. The files contained in these directories will be compiled and included in the resulting library.
- `COMPONENT_OBJS` – The set of object files that we need as a target.
- `COMPONENT_EXTRA_CLEAN` –
- `COMPONENT_BUILDRECIPE` –
- `COMPONENT_CLEANRECIPE` –
- `COMPONENT_BUILD_DIR` –
- `COMPONENT_EMBED_FILES` – This takes a list of binary files that are then added into the application. The start of the data in flash that corresponds to the file data is then exposed as a linker symbol. The same is also true for the last byte of the file giving two symbols in total. For example, if we were to embed a file called "mydata.dat", we might use:

```
COMPONENT_EMBED_FILES:= mydata.dat
```

This would produce two new symbols called `_binary_mydata_dat_start` and `_binary_mydata_dat_end`. These could then be used in an application by using:

```
extern uint8_t mydata_dat_start[] asm("_binary_mydata_dat_start");  
extern uint8_t mydata_dat_end[]   asm("_binary_mydata_dat_end");
```

Note that a change to the file on the file systems does not appear to cause a re-build and the old data is used.

- `COMPONENT_EMBED_TXTFILES` – This is identical to `COMPONENT_EMBED_FILES` except that a `NULL` character is added at the end of the data to produce a `NULL` terminated string. This might be used if the file contained character data.
- `CFLAGS` – Use this setting to change C compiler flags passed to the module. Take care to realize that the environment already passes in flags so don't use absolute settings. Instead use "`CFLAGS+=<value>`" to maintain the existing values while adding new ones.

In an ESP-IDF profile, we will also find a Makefile that gets the build started. We can specify some interesting values in there:

- `SRC_DIRS` – A list of one or more directories that contain the source of the application we wish to build. The default for this is `main`.

See also:

- Adding a custom ESP-IDF component

## CMake

With normal make, we specify a series of commands to be executed to achieve a goal. However, those commands are usually environment specific. For example, if our goal is to compile a C source file to an executable, the command to achieve this on Linux is one command while on Windows it is a distinct command. This means that if we write a Makefile, the result is actually platform and environment specific. The idea behind CMake is to raise the abstraction to a higher level. With make, we describe what we want **and** how to achieve it. With CMake, we describe what we want and CMake will inject how to achieve it.

On Ubuntu, we want to install CMake using:

```
$ sudo apt-get install cmake
```

At the highest level, we tell CMake what the result of a build should be. This is typically a binary. We also tell CMake what source files are used to build that binary:

```
add_executable(myBinary mysource1.cpp mysource2.cpp)
```

If we are constructing a library, we can use the `add_library()` command. This names the library we wish to create and the source files which should be compiled and placed within it.

```
add_library(myLibrary STATIC mysource1.cpp mysource2.cpp)
```

As an alternative to naming the required source files for our target in the `add_executable()` or `add_library()` command, we can add the source files manually using the `target_sources()` command.

```
add_executable(myBinary)
target_sources(myBinary PUBLIC mysource1.cpp)
target_sources(myBinary PUBLIC mysource2.cpp)
```

CMake works off a configuration file called "CMakeLists.txt".

A trivial example would be:

```
cmake_minimum_required (VERSION 2.6)
project (Tutorial)
add_executable(Tutorial tutorial.cpp)
```

See also:

- [CMake.org](http://CMake.org)
- [ESP-IDF CMake build system preview](#)

## The ESPTOOL protocol

The Espressif `esptool` is the standard utility for flashing an ESP32 and working with low level aspects of the device. This is a Python based application that can run on Linux or Windows. The source of the tool can be found on Github.

When an ESP32 is booted, it can boot into one of two modes. The first is the normal mode where the application that has been written to flash is loaded and executed. There isn't much more to say about that scenario in this part of the story. The second mode is where a "stub loader" application is loaded.

When the `esptool` starts, it sends a command known as a "Sync Frame". It sends this at different baud rates until it receives a response. The sync frame is composed of 36 bytes that are:

```
0x07 0x07 0x12 0x20 0x55 0x55 ... 0x55
```

To perform testing, we hooked in a Logic Analyzer into the story. The request protocol (to ESP32) is as follows:

Byte	Name	Notes
0	Direction	0x00 for requests
1	Command	One of the commands.
2-3	Size	
4-7	Checksum	Used in MEM_DATA, FLASH_DATA and FLASH_DEFL_DATA otherwise 0.
8..n	Data	

This whole record is encapsulated in a SLIP packet that starts and ends with 0xC0. The SLIP protocol escapes a couple of values.

Single byte	Escape bytes
0xc0	0xdb 0xdc
0xdb	0xdb 0xdd

The response protocol (from the ESP32) is as follows:

Byte	Name	Notes
0	Direction	0x01 for responses
1	Command	Same command as the request.
2-3	Size	
4-7	Value	Present on <b>only</b> some commands
8..n	Data	
4 bytes	Status/Error code	The status code is 0 for good and 1 for an error. The error codes are as yet unknown.

The command codes are:

Code	Name	Description
0x02	FLASH_BEGIN	
0x03	FLASH_DATA	
0x04	FLASH_END	
0x05	MEM_BEGIN	
0x06	MEM_END	
0x07	MEM_DATA	
0x08	SYNC	
0x09	WRITE_REG	
0x0A	READ_REG	
0x0B	SPI_SET_PARAMS	
0x0D	SPI_ATTACH	
0x0F	CHANGE_BAUDRATE	
0x10	FLASH_DEFL_BEGIN	
0x11	FLASH_DEFL_END	
0x13	SPI_FLASH_MD5	
0xD0	ERASE_FLASH	
0xD1	ERASE_REGION	
0xD2	READ_FLASH	
0xD3	RUN_USER_CODE	

Examining the logic traces we see the sender send:

0x08 – SYNC

0x0A – READ\_REG – 0x0c 0xa0 0x01 0x60 – 0x6001 a00c – read word 3 of eFuse

- This contains silicon revision, chip name.

0x05 – MEM\_BEGIN – size: 3104 (0xc20), number of packets: 1, size of one packet: 6144 (0x1800), address: 0x4009 0000

0x07 – MEM\_DATA – size 3104 (0xc20), sequence 0

0x05 – MEM\_BEGIN – size: 4, number of packets: 1, size of one packet 6144 (0x1800), address: 0x3ffd 2ba4

0x07 – MEM\_DATA

0x06 – MEM\_END

What follows is a run\_spi\_flash\_command()

0x0A – READ\_REG – 0x1c 0x20 0x00 0x60 – 0x6000 201c – SPI\_USR\_REG



0x0A – READ\_REG – 0x24 0x20 0x00 0x60 – 0x6000 2024 – SPI\_USR2\_REG  
 0x09 – WRITE\_REG – 0x6000 202c ← 0x0000 0017 - SPI\_MISO\_DLEN\_REG  
 0x09 – WRITE\_REG – 0x6000 201c ← 0x9000 0000 – SPI\_USR\_REG  
 0x09 – WRITE\_REG – 0x6000 2024 ← 0x9f00 0070 – SPI\_USR2\_REG  
 0x09 – WRITE\_REG – 0x6000 2080 ← 0x0000 0000 – SPI\_W0\_REG  
 0x09 – WRITE\_REG – 0x6000 2000 ← 0x0004 0000 – SPI\_CMD\_REG  
 0x0A – READ\_REG – 0x6000 2000 – SPI\_CMD\_REG  
 0x0A – READ\_REG – 0x6000 2080 – SPI\_W0\_REG  
 0x09 – WRITE\_REG – 0x6000 201c ← 0x8000 0040 – SPI\_USR\_REG  
 0x09 – WRITE\_REG – 0x6000 2024 ← 0x0000 0000 – SPI\_USR2\_REG  
 0x0B – SPI\_SET\_PARAMS  
 0x02 – FLASH\_BEGIN  
 0x03 – FLASH\_DATA  
 ...

The checksum is a single byte calculated by starting with a seed value of 0xEF and then performing an XOR over all the bytes to be sent. The checksum is a single byte but the reserved space in the header is 4 bytes. The checksum value should be written as a 32 bit little endian value. The checksum is only required for some commands, specifically:

- MEM\_DATA
- others ...

For the other commands, supply checksum as the value 0.

See also:

- [Github: espressif/esptool](#)
- [Serial Protocol](#)

#### 0x02 - FLASH\_BEGIN

- Size to erase
- Number of data packets
- Data size in one packet

- Flash offset

Here is an example:

0xC0 – SLIP header

0x00 - Request

0x02 – FLASH\_BEGIN command

0x10 0x00 – Length of data 0x10 – 16 bytes

0x00 0x00 0x00 0x00 – Checksum

0xE0 0x45 0x00 0x00 – 0x45E0 – 17888

0x02 0x00 0x00 0x00 – 2

0x00 0x40 0x00 0x00 – 0x4000 – 16384

0x00 0x10 0x00 0x00 - 0x1000

0xC0

#### 0x03 - FLASH\_DATA

- Size
- Sequence number
- 0
- 0
- Data

#### 0x04 - FLASH\_END

- command – 0 – reboot, 1 – stay in loader

#### 0x05 - MEM\_BEGIN

Perform a begin RAM operation.

- `Size` – The size of the data to be written in bytes.
- `Number of data packets` – The number of packets to expect.
- `Size of one packet` – The maximum size of a packet.
- `Offset of RAM` – The address/offset in RAM where the data is to be written.

The packets are read using `MEM_DATA` commands. We should expect the number of data packets to match the expected size. For example, the number of data packets should be:

```
roundUp(size / size of one data packet)
```

If we think of the ESP32 as a stateful entity, the `MEM_BEGIN` command indicates where in RAM the write should start and how much data is expected. Subsequent `MEM_DATA` commands use the `MEM_BEGIN` information for knowledge of where to write next. Following a `MEM_DATA`, the internal notion of where to write next will have been updated. As such, `MEM_DATA` doesn't include where to write that unit of data but only transmits the data by itself.

Here is an example:

0xC0 – SLIP header

0x00 – Request

0x05 – `MEM_BEGIN` command

0x10 0x00 – Length of data (0x10 – 16 bytes)

0x00 0x00 0x00 0x00 – Checksum

0x20 0x0C 0x00 0x00 – Total size (0x0c20 – 3104 bytes)

0x01 0x00 0x00 0x00 – Number of packets (0x01)

0x00 0x18 0x00 0x00 – Data size in one packet (0x1800 – 6144 bytes)

0x00 0x00 0x09 0x40 – 0x4009 0000 – Offset

0xC0 – SLIP header

#### **0x06 - `MEM_END` command**

- Execute flag – Experimentation seems to show:
  - 0x0000 0000 – Jump to entry point address
- Entry point address – The entry point address to pass control to at the end of the memory load.

#### **0x07 - `MEM_DATA` command**

- size – The amount of data being transmitted in this unit.
- sequence number – The sequence number to send.

- zero
- zero
- data ...

When sending the `MEM_DATA` command, it is vital that the checksum field also be populated. The checksum is calculated over the original payload data that will become the RAM memory. Note that this is distinct from the data that may be sent in the payload of a transmitted UART message. If we look at this command, we see that the data being transmitted is 16 bytes of preamble followed by the memory data. The checksum should be calculated on the memory data only and not include the preamble.

#### 0x08 - SYNC command

Initially, the flashing app will send SYNC commands at differing baud rates. The ESP32 will attempt to recognize a SYNC command. When it does, it will send a SYNC response. This will result in the application knowing which baud rate to use for communications. The SYNC command consists of 36 bytes of:

0x07 0x07 0x12 0x20 0x55 0x55 ... 0x55

#### 0x09 - WRITE\_REG

- address
- value
- mask – Typically 0xff ff ff ff
- delay (microseconds) – Typically 0

#### 0x0A - READ\_REG

Read a register. The data is a 32bit address from which to read.

#### 0x0B - SPI\_SET\_PARAMS

The parameters are 6 32bit words:

- `id` – Always 0
- `total size` – var (eg. 40 0000 - 4MBytes)
- `block size` – Always 64 \* 1024
- `sector size` – Always 4 \* 1024
- `page size` – Always 256

- `status mask` – Always 0xFFFF

0x0D - SPI\_ATTACH

0x0F - CHANGE\_BAUDRATE

Two 32 bit words as parameters:

- New baud rate – Typical rates are:
  - 115200
  - 230400
  - 921600
  - others ...
- zero

0x10 - FLASH\_DEFL\_BEGIN

0x11 - FLASH\_DEFL\_DATA

0x12 - FLASH\_DEFL\_END

0x13 - SPI\_FLASH\_MD5

- address
- size
- zero
- zero

0xD0 - ERASE\_FLASH

0xD1 - ERASE\_REGION

0xD2 - READ\_FLASH

0xD3 - RUN\_USER\_CODE

### The `flasher_stub`

The ESP32 has a flasher application in ROM which is responsible for processing the commands received over UART from the `esptool`. However, a ROM application is fixed in time and if bugs or enhancements are needed, we have to wait for a new hardware release before we have a chance of change. To alleviate this, an application called the



we end up with

```
stub_flasher_32.elf:      file format elf32-xtensa-le
architecture: xtensa, flags 0x00000112:
EXEC_P, HAS_SYMS, D_PAGED
start address 0x40090564
```

We can then parse the entry point out using:

```
$ xtensa-esp32-elf-objdump --wide --file-headers stub_flasher_32.elf | sed -n '/start
address/s/start address 0x\([[[:alnum:]]\)]\1/p'
```

With that information, our `esptool` loader can now load those sections into memory using the commands `MEM_BEGIN`, `MEM_DATA` and `MEM_END`. When the `flasher_stub` is running, it will respond with the 4 characters `OHAI`.

### Using Node-JS for an esptool

With the knowledge of how the `esptool` protocol works, the next question is "Can we implement an alternative other than `esptool`?". We immediately need to stress that `esptool` is great. There is no obvious need to recreate `esptool` for the vast majority of purposes. However, if you need a custom flasher tool, we should be able to achieve that.

### Esptool and SPI flash

One of the primary capabilities of the `esptool` is to read and write from flash. At the super low level at which we are working, we may need to control how the ESP32 accesses flash. Since the ESP32 uses SPI to access flash we too must drive the SPI to access that flash.

A typical `esptool` usage loads three files into flash:

- 0x1000 `bootloader.bin`
- 0x8000 `partitions.bin`
- 0x10000 `app.bin`

The `bootloader.bin` is special. It appears to contain a data structure that is then used to instruct the flash access subsystem on how to access flash. This appears to be a bootstrap puzzle but *just works*. The `bootloader.bin` **must** contain knowledge of the flash access mode (dio or qio), the flash speed and the size of flash memory available. Examining the source of `esptool`, we find that it *detects* when it is loading a

`bootloader.bin` and has the ability to patch the file with either command specified settings or with discovered settings.

The algorithm in `esptool` performs a `READ_REG` command against `SPI_USR_REG` (0x6000 201c).

The high level is to send a command byte followed by data and then read a response.

Addresses:

`SPI_CMD_REG = 0x00`

`SPI_USR_REG = 0x1C`

`SPI_USR1_REG = 0x20`

`SPI_USR2_REG = 0x24`

`SPI_W0_REG = 0x80`

`SPI_USR_COMMAND = BIT(31)`

`SPI_USR_MISO = BIT(28)`

`SPI_USR_MOSI = BIT(27)`

`flags = SPI_USR_COMMAND BIT(31)`

`flags |= SPI_USR_MISO`

`flags |= SPI_USR_MOSI`

`writeReg(SPI_USR_REG, flags)`

`writeReg(SPI_USR2_REG, ...)` ... write bitlen and command value - `SPIFLASH_RDID`

## Forums

There are a couple of excellent places to ask questions, answer other folks questions and read about questions and answers of the past.

- [ESP32 Community Forum](#) – The ESP32 community forum where **all** discussions of ESP32 are happening.

## Reference documents

Espressif distributes PDF and Excel spreadsheets containing core information about the ESP32. These can be downloaded freely from the web.

- [ESP32 Technical Reference Manual](#)
- [ESP-WROOM-32 Datasheet – 2017-05-04](#)
- [ESP32 Datasheet](#)
- [ESP32\\_RTOS\\_SDK](#)
- [ESP32 Pin List – V2.0](#)
- [ESP32\\_RTOS\\_SDK API Reference v1.1.0](#)



- [ESP-IDF Getting Started Guide](#)
- [ESP32 AT Instruction Set and Examples](#)
- [Mastering the FreeRTOS real time kernel](#)

## Github

There are a number of open source projects built on top of and around the ESP8266 that can be found on Github. Here is a list of links to some of these projects that are very well worth having a look:

- [espressif/esp-idf](#) – The ESP-IDF ... without this we would have little to talk about.
- [espressif/esp-idf-template](#) – The template application from which we build new applications.
- [espressif/arduino-esp32](#) – The Arduino environment for the ESP32.

## Github quick cheats

When working with open source projects, there are times when we would like to perform some tasks that involve multiple commands. Here we try and capture some of the more interesting ones that are used in ESP32 projects from time to time.

```
git remote -v
git remote add upstream <URL>
git fetch upstream
git merge upstream/master
```

To create a new repository in Github from a directory of goodies, do the following.

1. Create a new github repository
2. echo "# <repository name>" >> README.md
3. git init
4. git add README.md
5. git commit -m "first commit"
6. git remote add origin https://github.com/<repository>.git
7. git push -u origin master

See also:

- [Simple guide to forks in GitHub and Git](#)

## Installing Ubuntu on VirtualBox

I have a personal preference on the environment on which I perform development. I like to program on a Linux environment. I use Microsoft Windows for all my desktop work including document editing, browsing, email and much, much more ... however when it comes to programming, I like Linux. I do **not** want you to believe that in order to work with the ESP32 that you **must** use Linux ... that is simply not true. However, if you do decide that you want to use Linux then you will need a Linux environment. Historically, one would load an operating system on a machine and that would be the end of the story. One machine equals one operating system. Thankfully, those days are past and we can now adopt virtual machines. A virtual machine is a logical machine that runs as a "guest" under a host operating system. In our story, we want a virtual Linux machine running as a guest on a Windows or MacOS host. There are many fine vendors of virtual machine technology. The one I have chosen to illustrate in this story is [VirtualBox](#) from Oracle. This is an open source implementation that is free for us to use.

Let us now look at the steps necessary to get a Linux environment up and running for ESP32 development. I will assume that you have downloaded and installed the latest VirtualBox. Next we need an image of Linux to install. Personally, I use Ubuntu Desktop which can be downloaded [here](#). The end result of the download will be a file about 1.5GBytes in size. At the time of writing, the download was called "ubuntu-16.04.2-desktop-amd64.iso". The file is an image of a DVD that could be burned and installed from physical media however we don't need to do that, we can install directly from this image.

1. Launch VirtualBox
2. Click "New" to create a new Virtual Machine

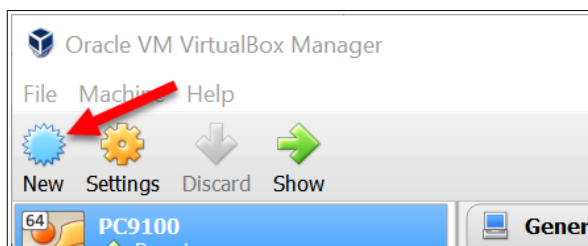

3. Give it a name (eg. "ESP32Linux") and specify its type (Linux) and version (Ubuntu 64Bit)

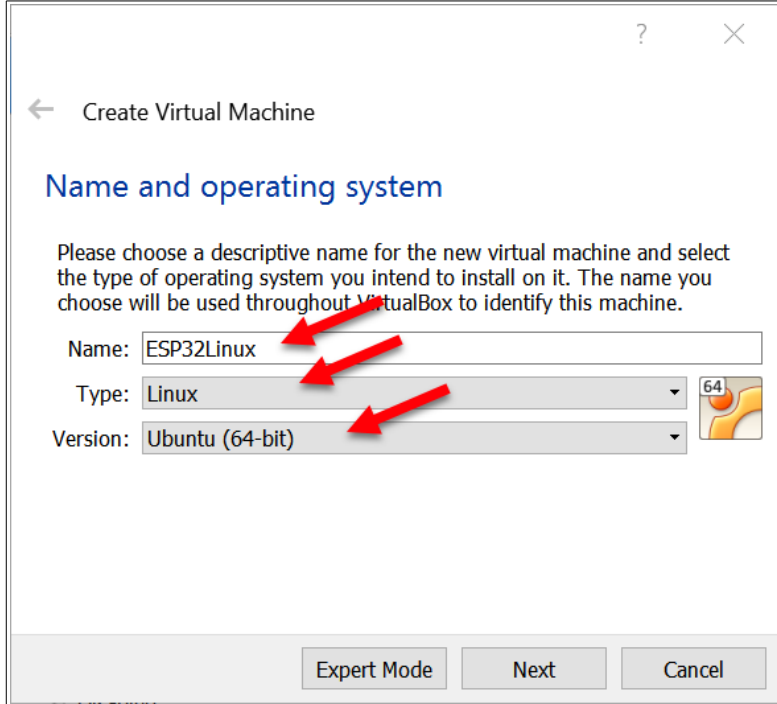

Click "Next" to continue.

4. Specify how much RAM you want to give the machine.

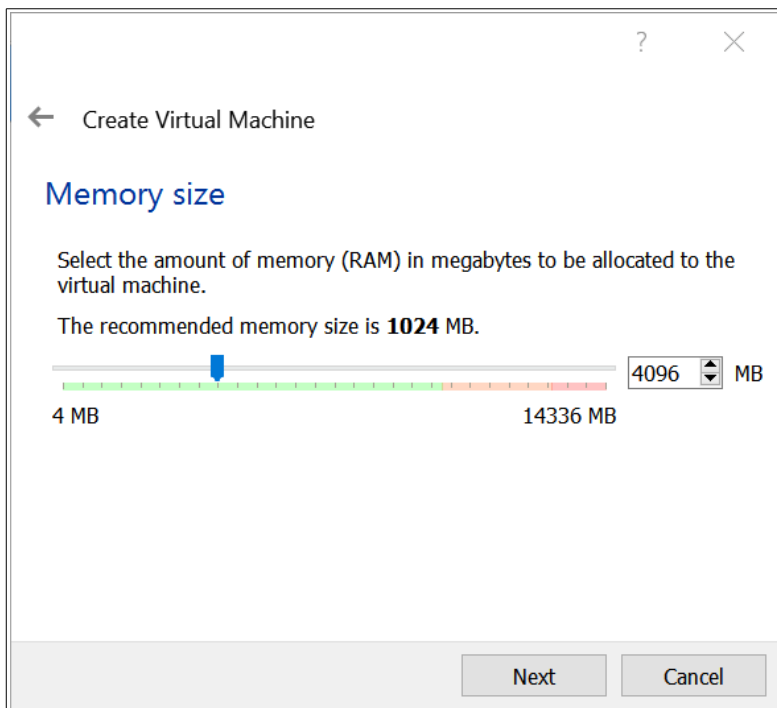

5. Create a virtual disk

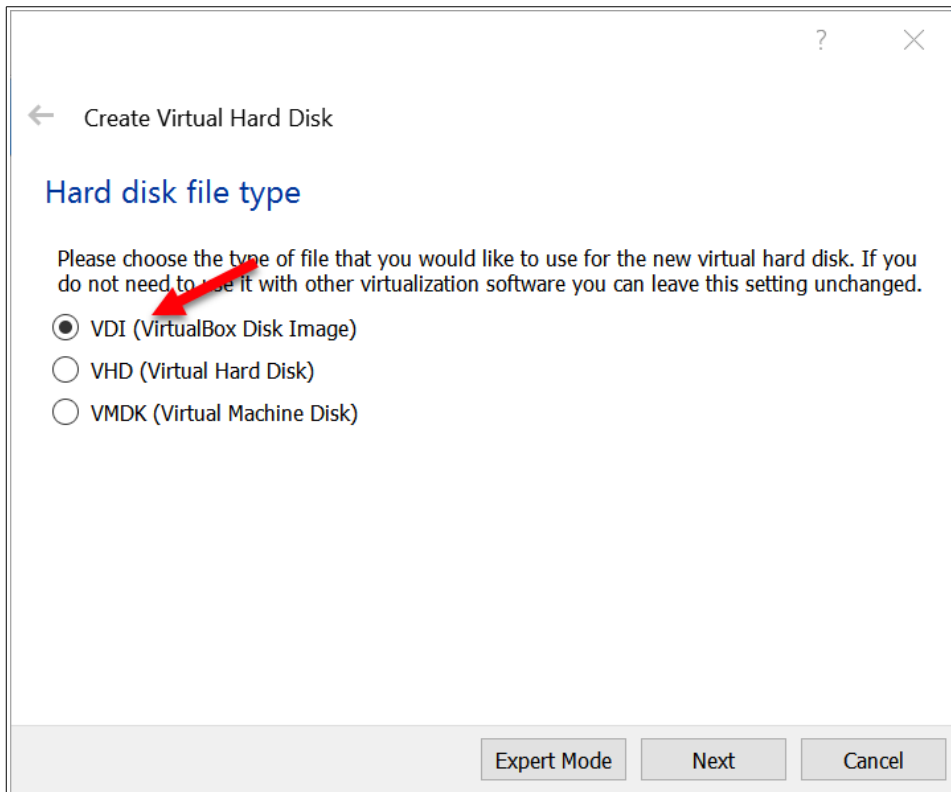
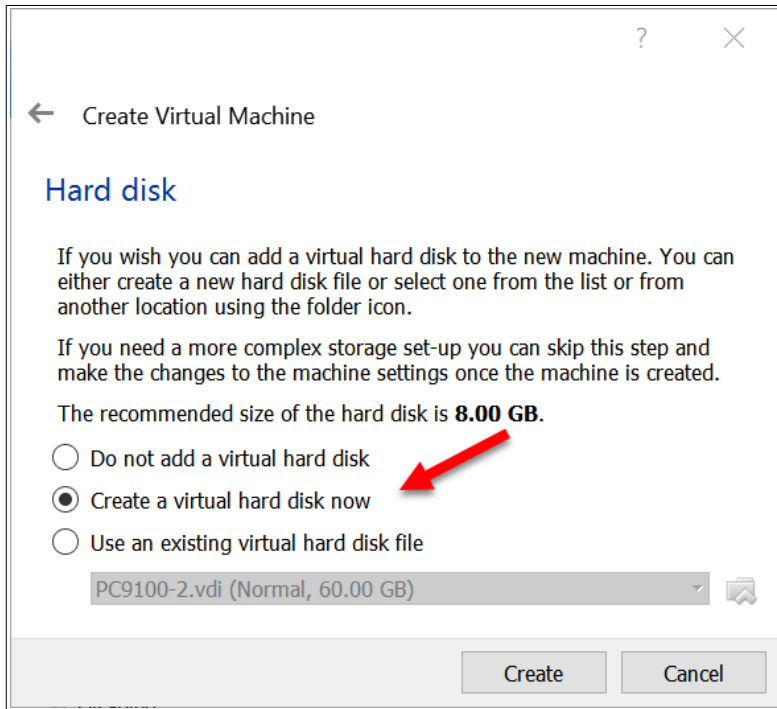

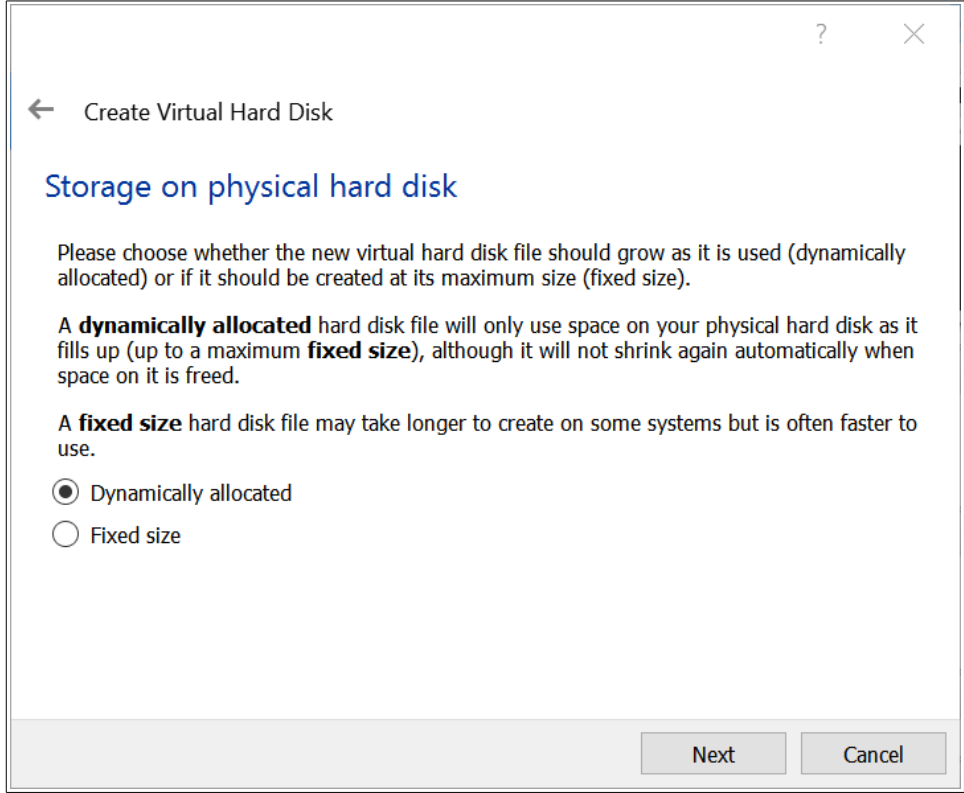

## 6. Start the Virtual Machine

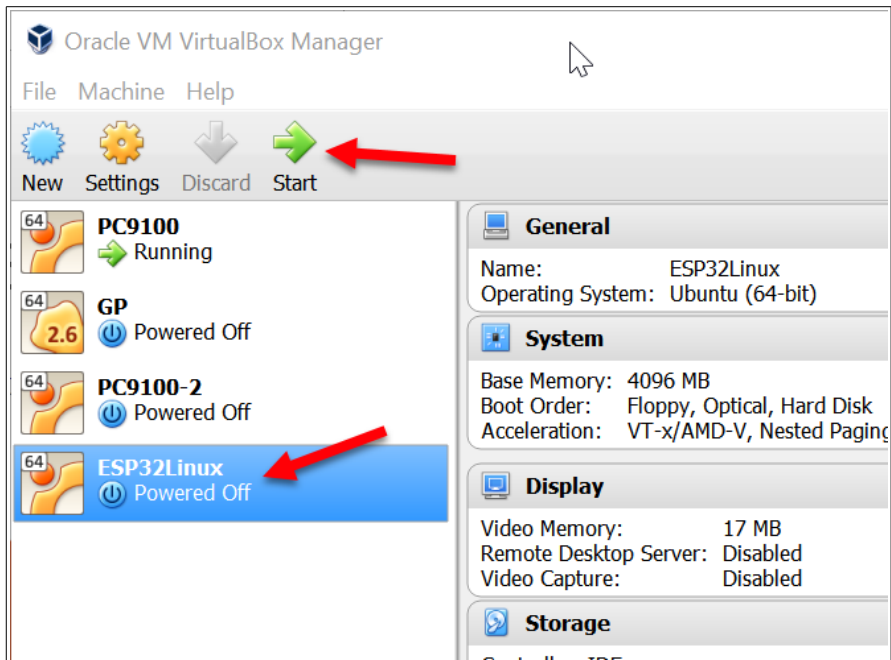

## 7. Select the Linux installation image

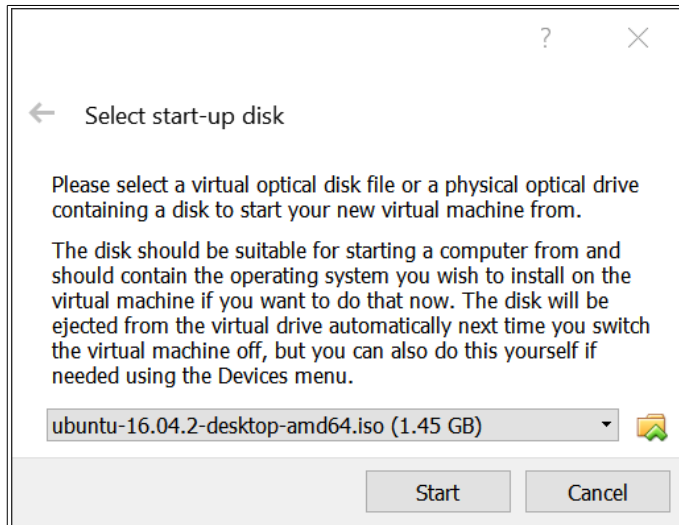

## 8. Install Linux

The installation of Ubuntu Linux will now start and take some time to complete. Ten minutes seems to be about average.

## 9. Reboot and be in Linux.

Reboot the virtual machine and you will find that you have a Linux environment in which to work.

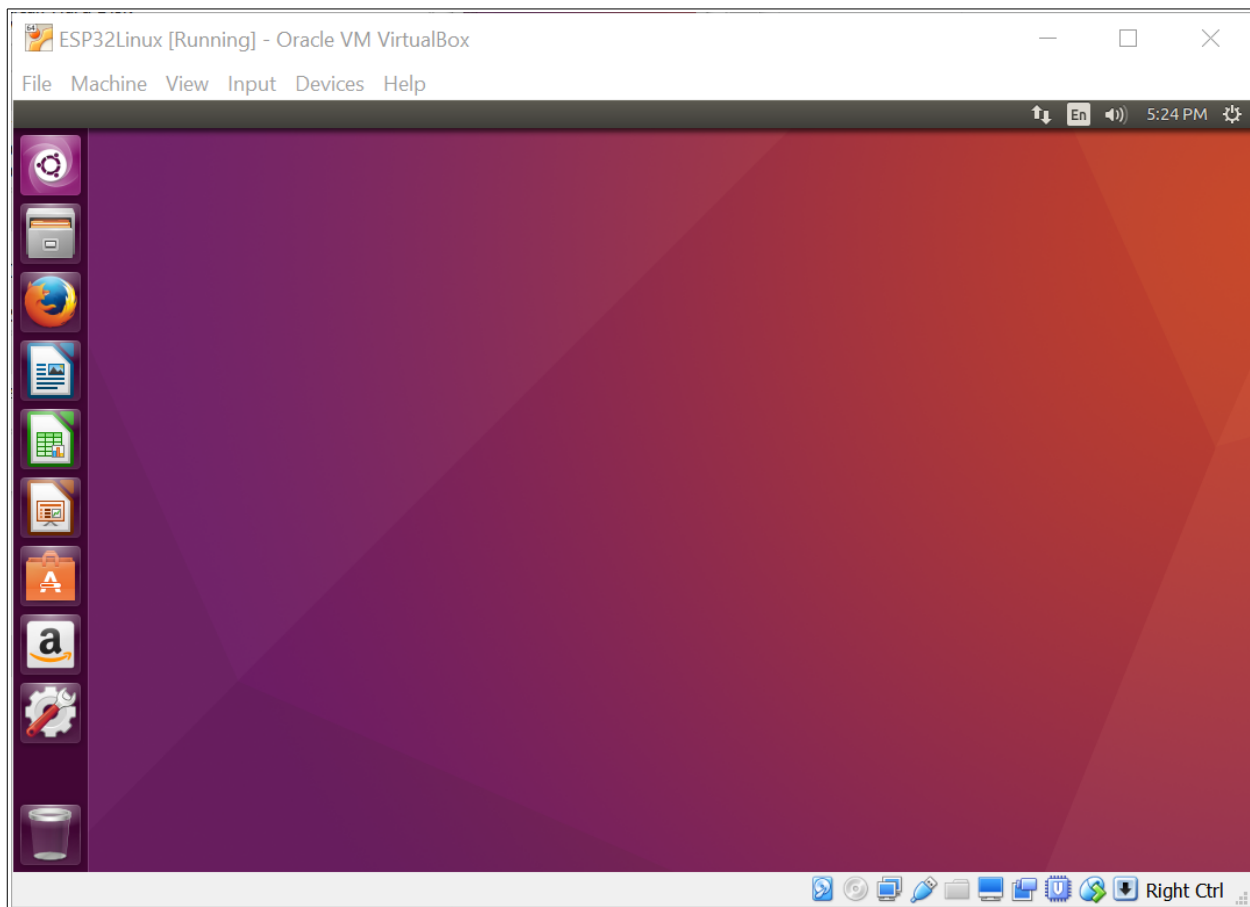

You can now customize the environment as you wish. Typically I remove the items I don't want from the task bar including FireFox, Libre Office, Ubuntu Software and Amazon.

When you plug in an ESP32 to the USB port of a machine running Virtual Box, you may also have to tell Virtual Box to "own" the USB→UART ... in the Devices→USB settings you can see a list of USB devices to add:

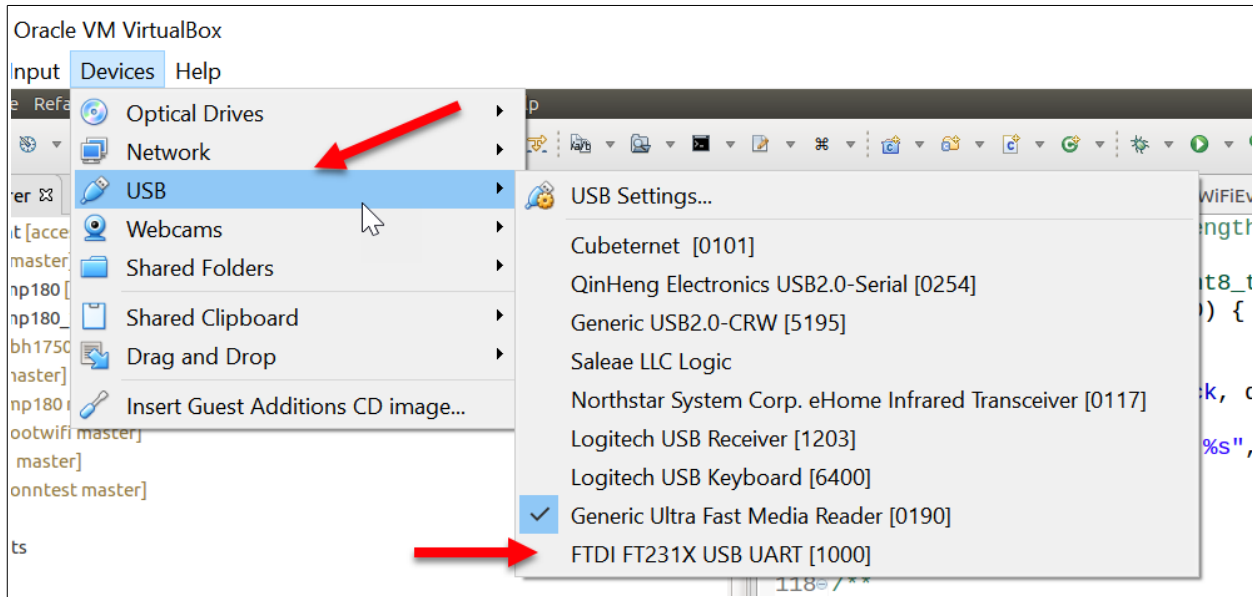

Its been my experience I have to re-add it here each time after powering on the Virtual Box.

## Single board computer comparisons

There are a number of single board computers on the market. Although the ESP8266 is usually not considered one of these, a lot of folks are using it as such. Let us put up a table and contrast the ESP32 against these computers:

Device	CPU	RAM	Flash	Wifi	GPIO	OS	Cost
<a href="#">ESP8266</a>	80MHz	80K	512K	Y	9	FreeRTOS	\$4
ESP32	160MHz	512K	Var	Y	?	FreeRTOS	??
<a href="#">Arduino</a>	20MHz	2K	32K	N	?	N/A	\$2
<a href="#">Pi Zero</a>	1GHz	512MB	SD	N	?	Linux	\$5
<a href="#">Omega</a>	400MHz	64MB	16MB	Y	18	Linux	\$19
Omega 2							
<a href="#">C.H.I.P.</a>	1GHz	512MB	4GB	Y	8+	Linux	\$9

## Areas to Research

- Hardware timers ... when do they get called?



- If I define functions in a library called libcommon.a, what is added to the compiled application when I link with this library? Is it everything in the library or just the object files that are referenced?
- How much RAM is installed and available for use?
- Document the information contained here ...  
<http://bbs.espressif.com/viewtopic.php?p=3066#p3066>
- What is SSDP and how does it related to the SSDP libraries?
- Study Device Hive - <http://devicehive.com/>
- Document using Visual Micro debugger with Visual Studio.  
<http://www.visualmicro.com/>
- Power management
- Research the semantics of a wifi\_station\_connect() when we are already connected.
- Look at using libssh2 as a library in ESP32
- In power management – what is RTC?
- In power management – what is ULP?
- Study IoT.js
- Look at the GDB post here ... interesting subcommand .  
<http://esp32.com/viewtopic.php?f=2&t=767>
- How do we set a static IP address for the ESP32 when it is an access point?
- research micro sd APIs
- Study the following <http://esp32.com/viewtopic.php?f=13&t=924#p3997>
- Write about UDP broadcasting
- Add a section on MCP23017 port expander.
- Study [iot.espressif.cn](http://iot.espressif.cn)
- Study <http://platformio.org/>
- Video: Push button interrupts
- Video: Build from scratch – ESP-IDF, compilers etc etc
- Touchpad support

- Document the following <http://esp-idf.readthedocs.io/en/latest/build-system.html#embedding-binary-data>
- Do a video on watchdog processing
- What is WiFi promiscuous mode?
- Document how to compile JerryScript
- Document how to compile Duktape
- Write an APDS-9330 C++ class
- Add task management methods to the CPP class
- Examine the mDNS responder from apple as a possible port ... <https://opensource.apple.com/source/mDNSResponder/>
- Write and test instructions for building nrf24 on ESP32
- Implement partition logging in C++
- Build samples using ADX345 IC.
- Write up the AWS support.
- Retest the mDNS support now that we have extra patches.
- study grpc
- Test the libwebsockets <https://libwebsockets.org/>
- Implement a ZIP file system
- What is "esp\_set\_watchpoint" ... see <https://esp32.com/viewtopic.php?f=2&t=2421>
- Build an IR Transmitter app
- Create a video on being a BLE Client
- Build a DMA sample
- There are some notes here about enabling LWIP debugging ... test this out ... <https://esp32.com/viewtopic.php?f=2&t=2665&start=10>
- Study <https://github.com/me-no-dev/EspExceptionDecoder>
- In Eclipse, why use "Use default make command" in the C++ build tools.
- In BLE, how do we determine our own BDA (Blue tooth device address)
- Study this URL ... <https://esp32.com/viewtopic.php?f=13&t=2900>
- Write up MCPWM - <http://esp-idf.readthedocs.io/en/latest/api-reference/peripherals/mcpwm.html>

- Study the heap debug story here [https://esp-idf.readthedocs.io/en/latest/api-reference/system/heap\\_debug.html](https://esp-idf.readthedocs.io/en/latest/api-reference/system/heap_debug.html)
- study `esp_bt_controller_enable(ESP_BT_MODE_BLE)`; and `esp_bt_controller_mem_release(ESP_BT_MODE_BTDM)`; to reduce memory
- Write up Blynk on ESP32
- document `RTC_NOINIT_ATTR`
- What is event `SYSTEM_EVENT_AP_STAIPASSIGNED`?

Private Notes:

My Sparkfun board has devices on the I2C bus at:

- 0x20 – PCF8574
- 0x3C – SSD1305 display
- 0x68 – MPU6050

Special pins are:

PIN 21 – Buzzer – high/on, low/off

PIN 25 – I2C SDA (Green)

PIN 26 – I2C CLK (Yellow)

NRF24

VCC

GND

CE – White - 25

SCK – Blue - 14

MISO – Yellow - 12

IRQ – NA

MOSI – Green - 13

CSN – White - 15

